

YOTTACONTROL

Index	Contents
Overview	1
Communication	2
YottaEditor	3
YottaUtility	4

Controller

Manual

Edition 12.2013

Contents

1.Product Overview.....	4
1.1 Initial parameter.....	4
1.2 Controller Description.....	4
2. Communication.....	5
2.1 Controller communicates with the PC.....	5
2.2 A1 series Remote IO module communicates with the PC.....	7
3. YottaEditor overview.....	11
3.1 Main screen.....	11
3.2 Properties-General	11
3.3 Properties-Parameter.....	12
3.4 Properties-Protect	13
3.5 Properties-COM	14
3.6 Properties-Startup Bmp	15
3.7 Properties-Hardware	15
3.8 Communication Configuration.....	16
3.9 PC->Device	16
3.10 Device->PC.....	16
3.11 RTC.....	17
3.12 Summer Time and Winter Time.....	17
3.13 Clear User Program and Password.....	18
3.14 Simulation.....	19
3.15 Controller and IO module's IO setting.....	20
3.16 Remote IO Module's IO setting.....	21
3.17 Message Text.....	23
3.18 Controller display and ATP (text panel) menu structure.....	24
3.19 Controller application wiring.....	25
3.20 Controller POWER/RUN LED indicator.....	25
3.21 Controller memory card.....	26
3.22 Address Mapping.....	27
3.23 Example applications.....	36
3.23.1 Dual counter.....	36
3.23.2 School bell system.....	36

3.23.3 Redundant37

4.YottaUtility Overview.....38

4.1 Main screen.....38

4.2 The controller communicates with the PC.....38

4.2.1 Initial mode.....39

4.2.1.1 General setting.....39

4.2.1.2 Real Time Clock.....40

4.2.1.3 More information.....40

4.2.2 Normal mode.....40

4.3 More Information.....41

4.3.1 Controller Information.....41

4.3.2 System Info.....41

4.3.3 Tag Configuration42

4.3.3.1 Category43

4.3.3.2 Tag44

4.3.4 Digital45

4.3.5 Analog45

4.3.6 By Category45

4.3.7 Function Block46

4.4 Database48

4.5 Historical Trends50

4.6 Realtime Trends52

1. Product Overview

1.1 Initial parameter

Yottacontrol A-1188/1189、A-2188/2189、A-5188/5189、A-6188/6189 series 系列 Controller and A1 series Remote IO modules' initial setting parameter are as below:
 MODBUS RTU, ID Address:01, Baud Rate:9600, Parity: None, Data Bit:8, Stop Bit:1。

1.2 Controller Description

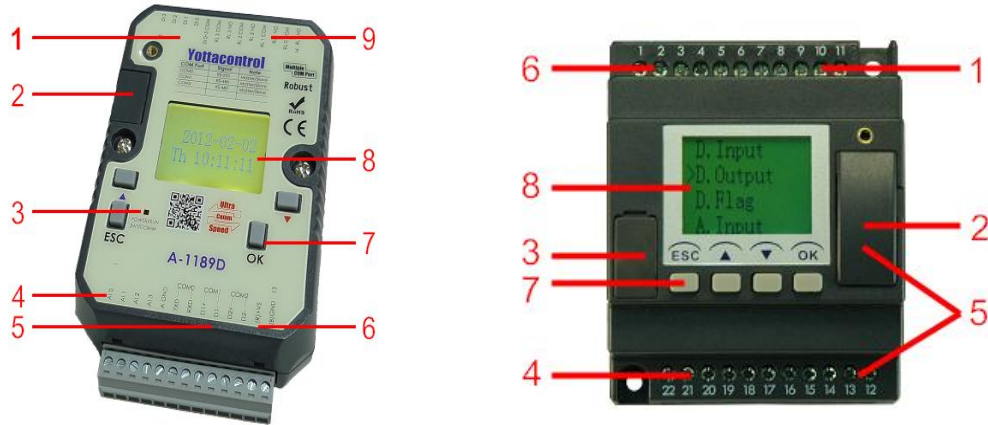

Item	Description
1	Inputs
2	Memory Card Slot
3	Indicator, Red: initial mode, Green: normal (run) mode, Spark: no program in controller A-2188/2189 & A-6188/6189: switch
4	Inputs
5	Communication Port (USB Port)
6	Incoming Power
7	Buttons
8	LCD display
9	Outputs

2. Communication

When you got Yottacontrol A-1188/1189、A-2188/2189、A-5188/5189、A-6188/6189 series Controllers or A1 series Remote IO Modules, can via YottaUtility to realize device parameter.

2.1 Controller communicates with the PC

A series Controller can connect via cables to communicate with PC's RS-232 port or USB port, or can via Converter to communicate with a PC.

1. Prepare Controller and Converter or DSCAB connect cable



2. Turn the Controller's switch to 'Init' status

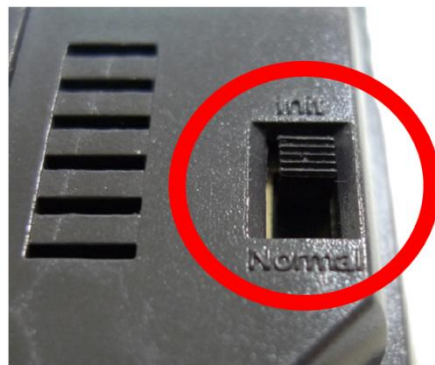

3. Link Controller to Converter via twisted pair cable

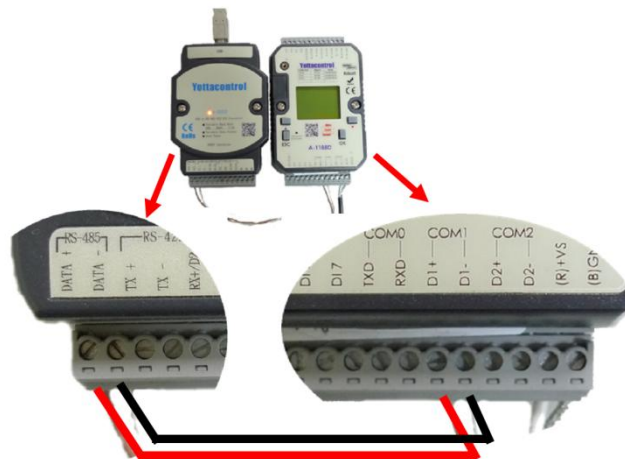

4. Or linked DSCAB connect cable

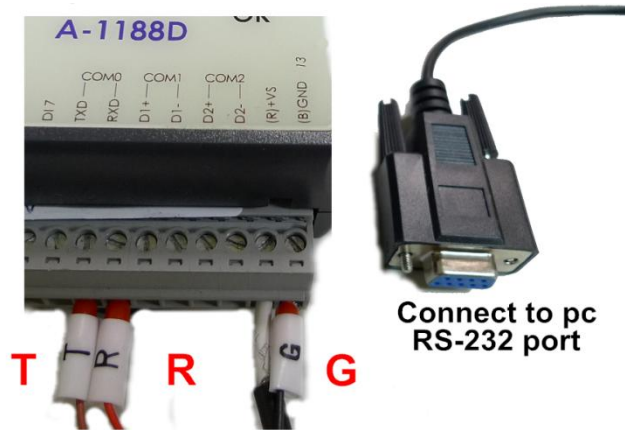

5. Turn on the Controller's power



6. Open YottaUtility and click **Refresh COM ports** to check PC's com ports, then choose Controller's COM port. And click **Search for modules** to search Controller

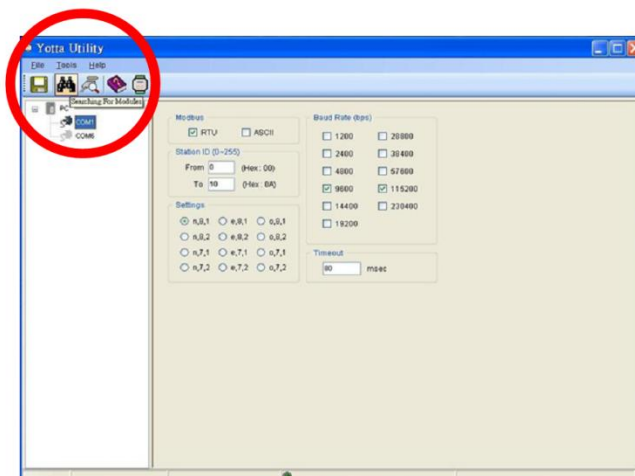

- When correct to search Controller, YottaUtility will show below figure. We can detect the Controller's all com ports' parameters.

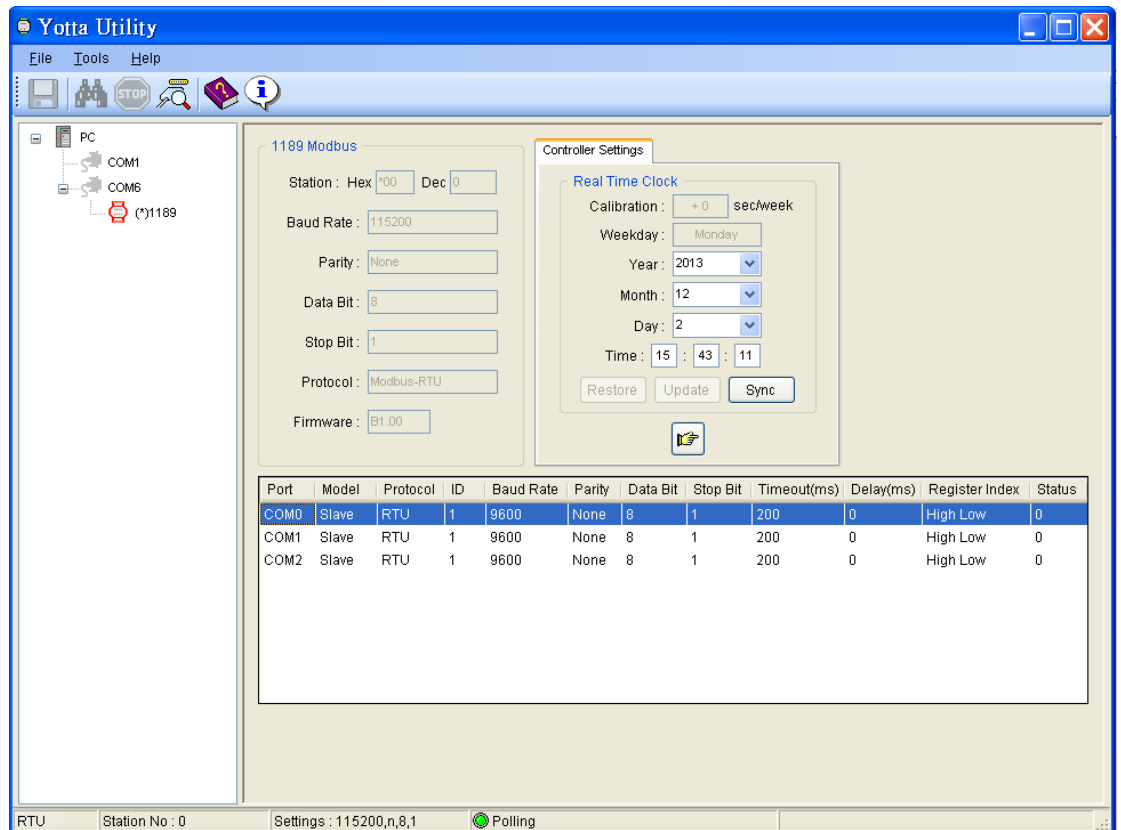

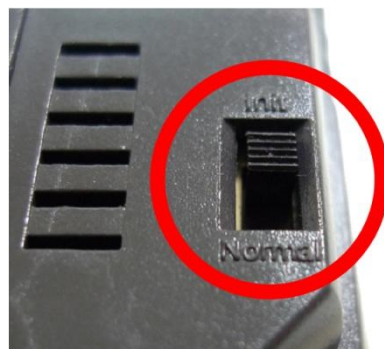

2.2 A1 series Remote IO module communicates with the PC

- A1 series Remote IO module build-in MODBUS RS-485 port, can via Converter to connect to PC. (Device DATA+ connect to Converter DATA+, device DATA- connect to Converter DATA-)
- Turn the Remote IO Module's switch to 'Init' status.



- Power on the Remote IO Module

- Open YottaUtility and click **Refresh COM ports**  to refresh PC com port, and choose Remote IO Module's com port. Then click **Search for modules**  to search device.

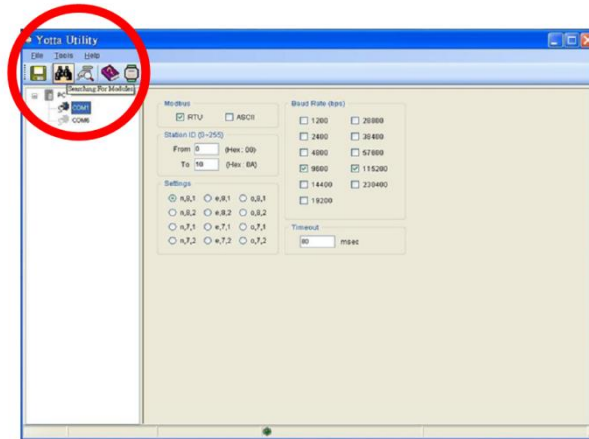

- When correct to search Controller, YottaUtility will show below figure. We can detect the Remote IO Module's parameters.

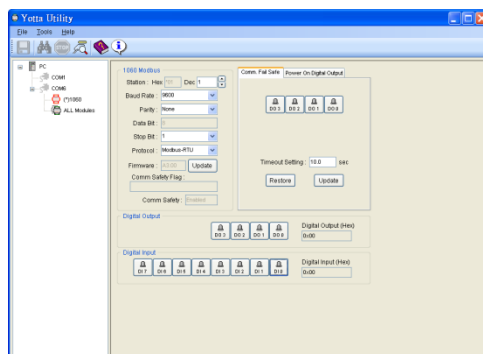

- We can set the communication parameter as below figure. For example, **DEC (ID Address) range is 1-255**. When finish the parameter setting, can press **Update** to save the setting.

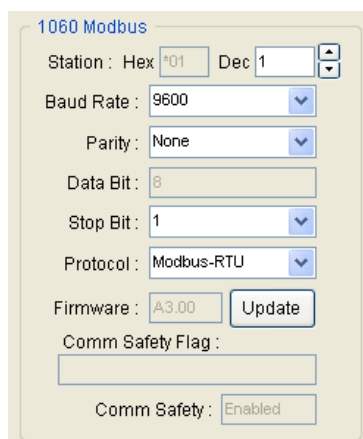

7. Or can click **Digital Output** to test device hardware's LED indicator.

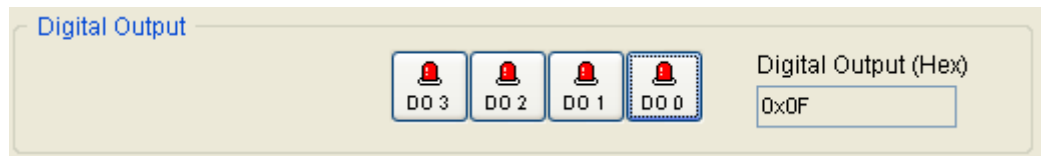

8. Remote IO Module via MODBUS RS-485 to communicate to other devices (PLC, HMI, Data Logger, etc.). To communicate fail warning, we can set related notify in Comm. Fail Safe. When finish it, press **Update** to save. Or can click **Restore** to restore device's current data.

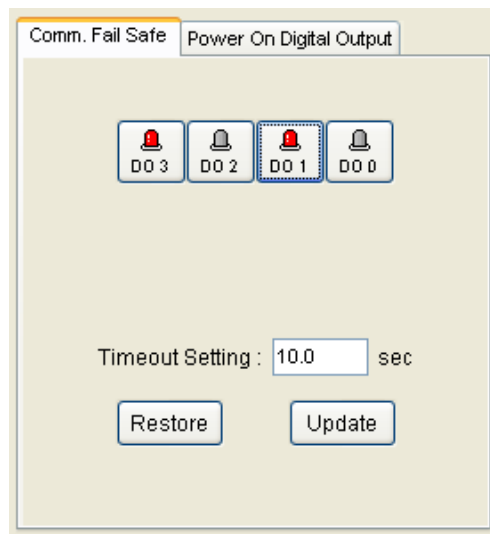

9. When turn on the Remote IO Module's power, can set the power on output indicator via **Power On Digital Output**. When finish it, press Update to save. Or can click Restore to restore device's current data.

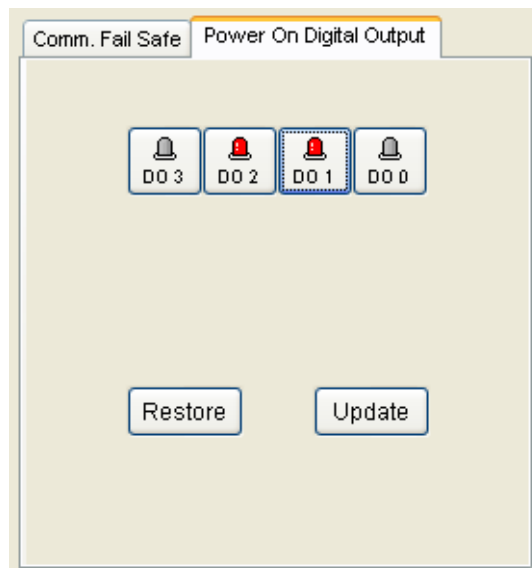

10. When complete above setting steps, turn the Remote IO Module's switch to 'Normal' status and re-turn on the power can finish the setting.



3. YottaEditor overview

3.1 Main screen

Item	Description
1	Menu bar
2	Standard toolbar
3	Programming interface
4	Information window
5	Status bar
6	Constants and connectors Basic functions Special functions

3.2 Properties-General

Properties

General | Comment | Parameter | Protect | COM0 | COM1 | COM2 | StartUp Bmp | Hardware

Creator:

Project Name:

Installation Name:

Customer:

Diagram no.:

Checked:

Version:

Show at new file

OK Cancel Help

In this tab, you can enter detailed information of a circuit program

3.3 Properties-Parameter

Program Name

A program name with up to 16 characters can be entered in the circuit program.

Program Password

A program password with up to 8 alphabetical characters can be assigned to protect the circuit program on the controller. Enter 2 identical passwords in the New Password and Repeat New Password text boxes separately to assign a new password for your circuit program. You can delete the assigned password by leaving New Password and Repeat New Password text boxes empty.

You can open or edit the circuit program from YottaEditor at any time no matter if the program is password-protected or not. For password-protected circuit programs, you have to enter the password to view or modify the program on the controller, or to load the circuit program from controller to YottaEditor.

Redundancy

The controller provides redundancy to help you build a robust system. In case the server is going down there is a backup server that can take over the job.

There are 3 types for you to choose.

None: Redundancy is not available for this type.

Master: Connected controller is the main controller of the whole system. It communicates with Slave continuously.

Slave: Connected controller becomes Master automatically, if it doesn't receive signals from the Master over a period of time which is defined in the Synchronizing time text box in milliseconds.

3.4 Properties-Protect

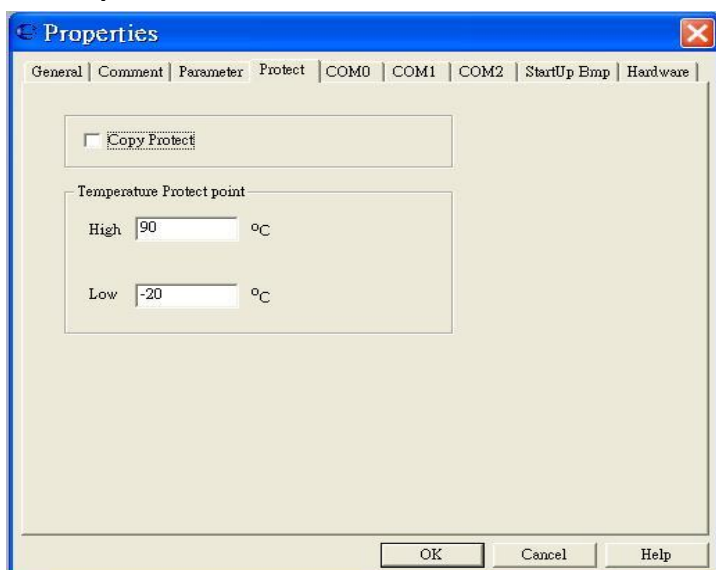

Copy Protect

When select this function, can protect program illegal download without the correct password.

Temperature Protect point

Set the temperature range. If work temperature surpasses the range, memory will record.

3.5 Properties-COM

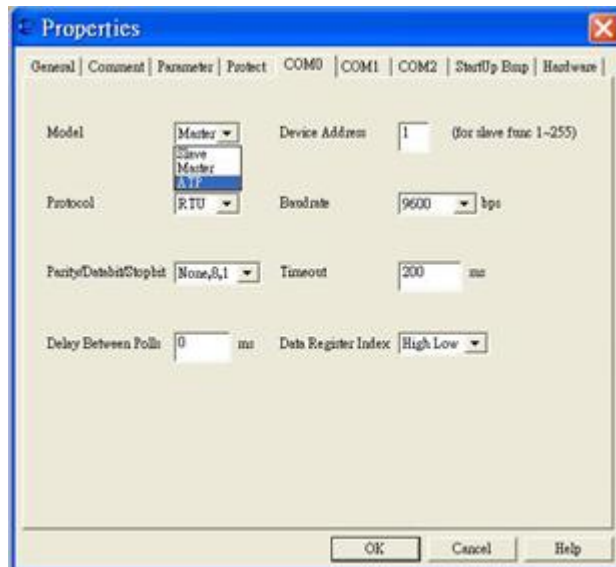

You can set the following parameters.

Model: Master, Slave, ATP (A series text panel)

Device address: From 1 to 255 (for slave only)

Protocol: Modbus-RTU, Modbus-ASCII

Baud rate: 1200, 2400, 4800, 9600, 14.4K, 19.2K, 28.8K, 38.4K, 57.6K, 115.2K, 230.4K (bps)

Parity/Data bit/ Stop bit: None, 8, 1/None, 8, 2/Odd, 8, 1/Odd, 8, 2/Even, 8, 1/Even, 8, 2

Timeout: In millisecond

Delay between polls: In millisecond

Data register index: High Low, Low High

3.6 Properties-Startup Bmp

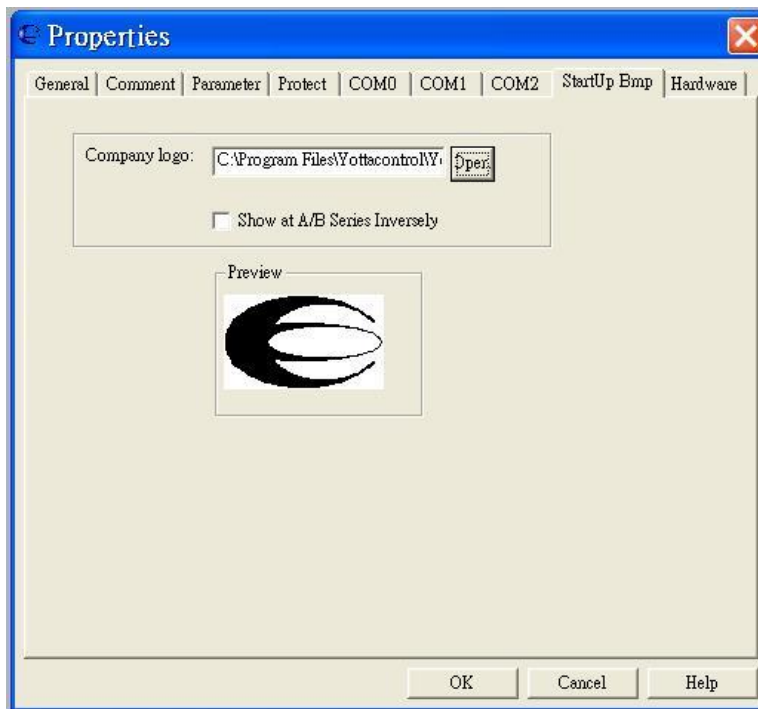

You can place any image into the controller in *.bmp format (108*64).

3.7 Properties-Hardware

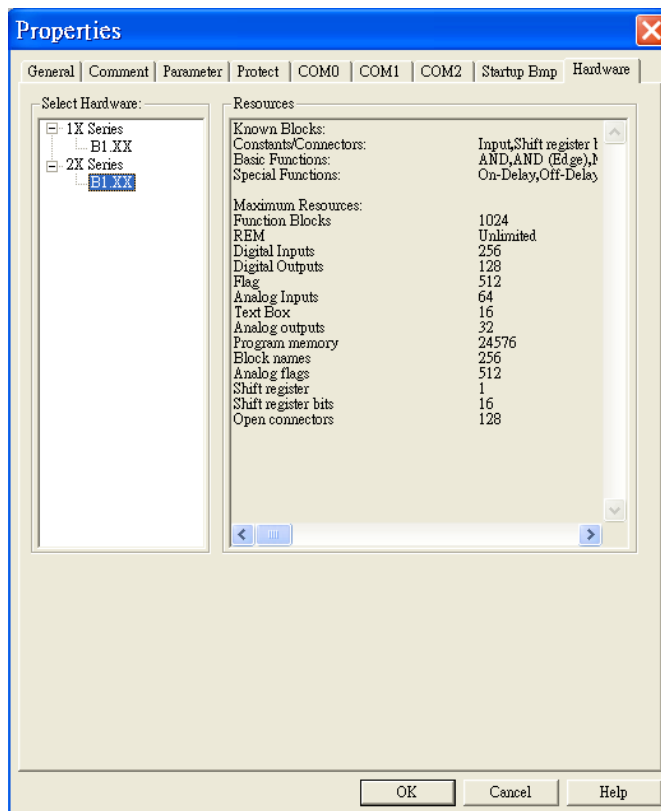

The device selection dialogue shows you which blocks and memory resources are available to you. **Please choose correct Controller type in this dialogue.**

3.8 Communication Configuration

Choose a COM port from the list, if you know exactly which one connects to the controller. If you are not sure which COM port connects to the controller, you can let YottaEditor automatically detect the COM port.

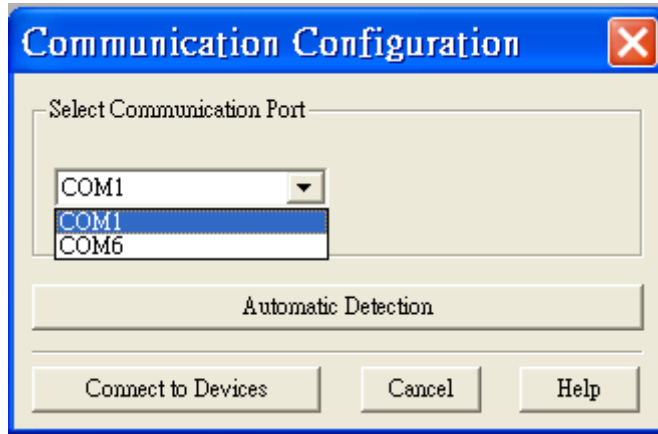

3.9 PC->Device

When complete the program, operate **Tools -> Transfer -> PC->Device** to download program into the controller. Or press Ctrl+D

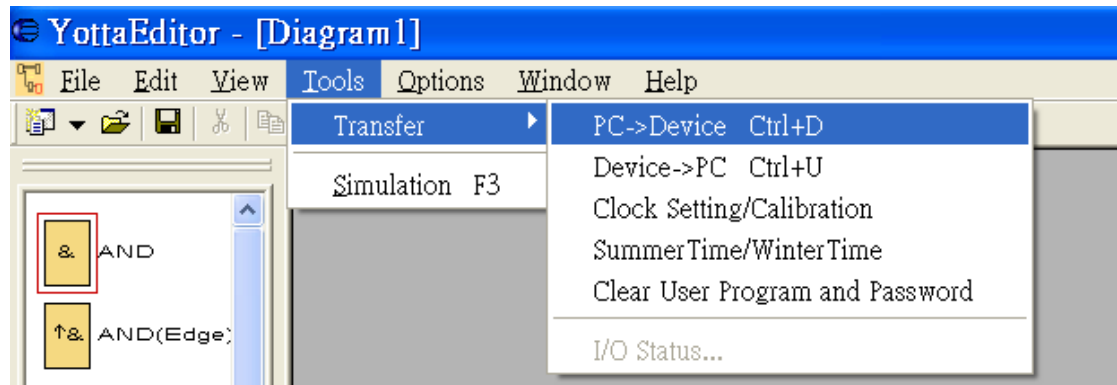

3.10 Device->PC

If you would like upload controller program to controller, operate **Tools -> Transfer -> Device->PC**. Or press Ctrl+U

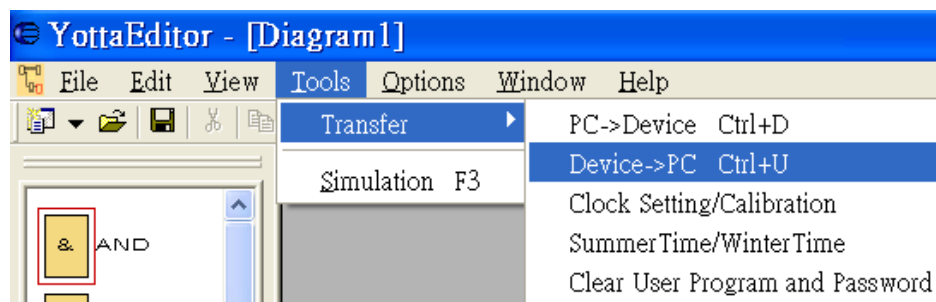

3.11 RTC

This command can be used to read and set the date and time of connected controller, operate **Tools -> Transfer -> Clock Setting/Calibration**

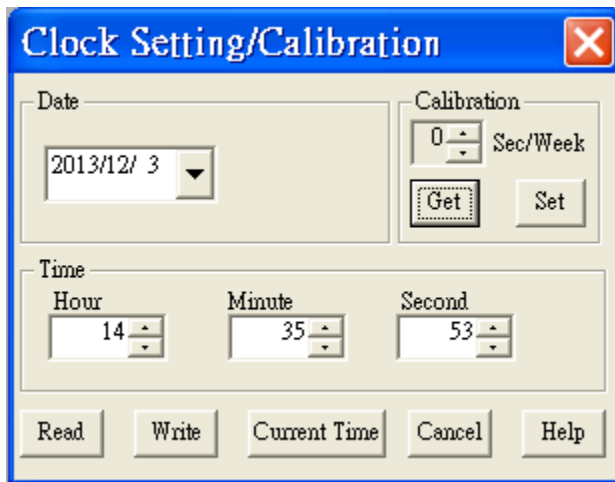

Calibration (Sec/week)	Get : Read controller calibration value
	Set : Save calibration value into the controller
Clock Setting	Read : Read controller RTC date and time
	Write : Save RTC date and time into controller
	Current Time : Read PC's current time and date

3.12 Summer Time and Winter Time

This menu command lets you set an automatic conversion of the summer and winter time for the controller's clock.



When you enable summer/winter time conversion, you can specify a country-specific time conversion:

- *EU: European Union
- *UK: United Kingdom of Great Britain and Northern Ireland
- *US: United States of America
- *Australia
- *Tasmania
- *New Zealand
- *Freely adjustable: customized switchover dates and times

For the "Freely adjustable" selection, you specify the month and the day of the switchover. The start time of summertime is 02:00 + the entered time difference; the end time is 03:00 – the entered time difference.

Note: The United States of America redefined the daylight saving time (summer time) / standard time (winter time) switchover dates in 2007. Controller, however, uses the switchover dates as they were prior to 2007. To use the new U.S. switchover times, you must configure a "Freely adjustable" setting that corresponds to the new rule where Daylight Saving Time is in effect from 2:00 a.m. On the second Sunday in March until 2:00 a.m. On the first Sunday in November according to the local time zone.

3.13 Clear User Program and Password

In [3.3 Properties-Parameter](#) mention about password protection. If you would like to clear the program and password can use this function. **Tools -> Transfer -> Clear User Program and Password**

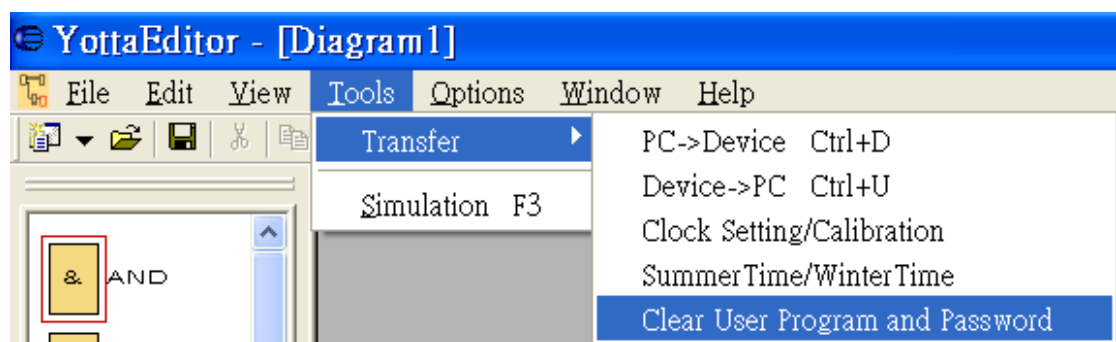

3.14 Simulation





Click on the **Tools -> Simulation**, or press F3 or click 

Simulation Toolbar

The simulation toolbar, which is shown as follows, is active when the program is in simulation mode. Use this tool to perform the simulation





Simulation Control Icons

	Simulate a power failure
	Start the simulation
	Stop simulation
	Suspend simulation. The Circuit program switches into suspend mode.
	Resume simulation

Time Control

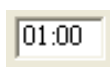
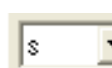
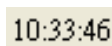
For a time-sensitive circuit program, you can use the time control to observe the processes of the circuit program. This is a simple but effective way to predict the result of the program operation.

	Start/stop the simulation in stepping mode. It's available in suspend mode.
	Set a specific period of time or set a specific number of cycles. Depends on the below control.
	Choose one of the four modes: cycle, second, minute and hour.
	Current time
	Modify the current time

Status Display

The value of the signal and corresponding connecting line is as follows:

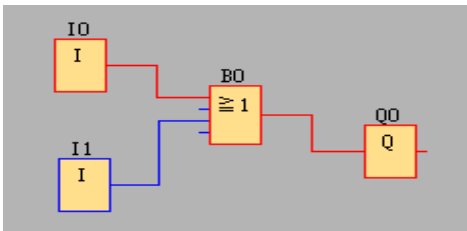
The value of signal	The colour of corresponding connecting line	
1	Red	
0	Blue	

3.15 Controller and IO module's IO setting

A-1188/1189、A-2188/2189、A-5188/5189、A-6188/6189 series controller offer plenty extend IO modules selection.



In YottaEditor, we can choose Input or Output to set Main controller or Extend IO module. A-2188/2189、A-6188/6189 series controller can connect 7 units Extend IO modules.

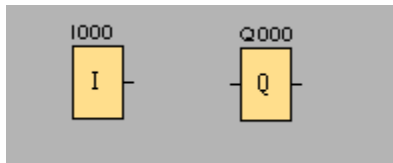

Module	Input Number	Output Number
Main (controller)	I000 ~ I015	Q000 ~ Q007
Ext.1 IO (Extend)	I100 ~ I115	Q100 ~ Q107
Ext.2 IO (Extend)	I200 ~ I215	Q200 ~ Q207
Ext.3 IO (Extend)	I300 ~ I315	Q300 ~ Q307
Ext.4 IO (Extend)	I400 ~ I415	Q400 ~ Q407
Ext.5 IO (Extend)	I500 ~ I515	Q500 ~ Q507
Ext.6 IO (Extend)	I600 ~ I615	Q600 ~ Q607
Ext.7 IO (Extend)	I700 ~ I715	Q700 ~ Q707

3.16 Remote IO Module's IO setting

A series Remote IO Module via MODBUS to communicate with controller, related IO setting is as below:

1. Controller to control Remote IO Module's output

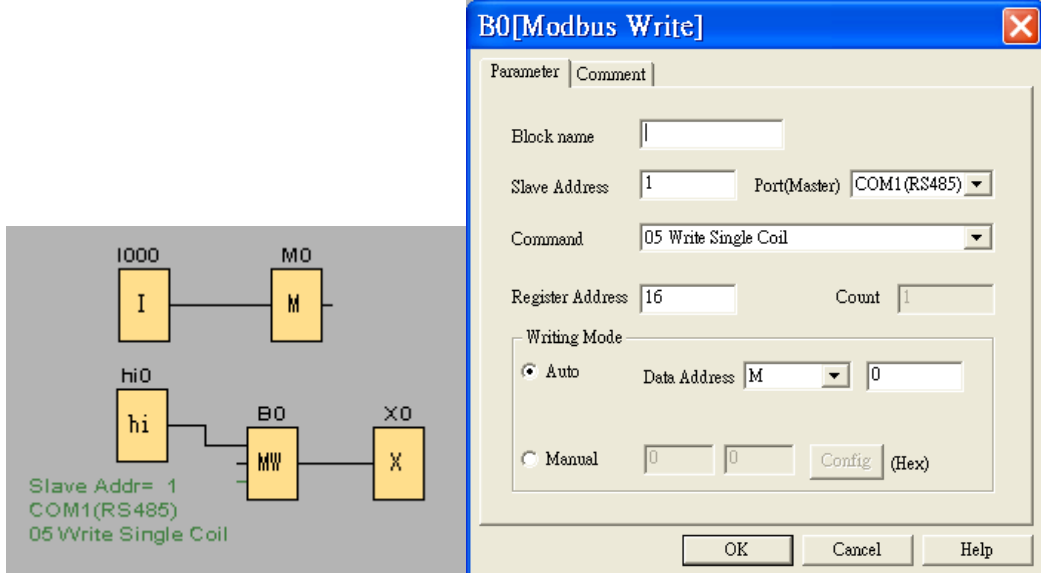

- A. For example, controller to control A-1060's output (8DI,4DO)
- B. Controller IO input data will store to M0 Flag block
- C. Hi0 block will enable B0 Modbus Write block (MW)
- D. B0 block will control A-1060's output, related parameter setting as below:
 - a. Slave Address: 1, All of Yottacontrol products' initial ID Address is 1. Controller's RS-485 port can connect to 255 units MODBUS devices. If you would like to connect more than 2 units devices at the same port, please set the different ID address for each device.
 - b. Port: COM1, set which com port would like to connect to other MODBUS device.
 - c. Command: 05 Write Single Coil, choose single or multiple coil/register.
 - d. Register Address: 16, fill in Remote IO Module's output address. **(Note, A series Remote IO Module output address starts from 16)**
 - e. Count: 1, fill in quantity of output control. If Command chooses Single, the value will disable.
 - f. Data Address: M0, controller IO data will store on M0 block, and transfer data to B0 block to control Remote IO Module's output. **Note: For program rule, B0 block must connect a block, so place X0 Open connector behind B0 count block.**

2. Controller to receive Remote IO Module's input

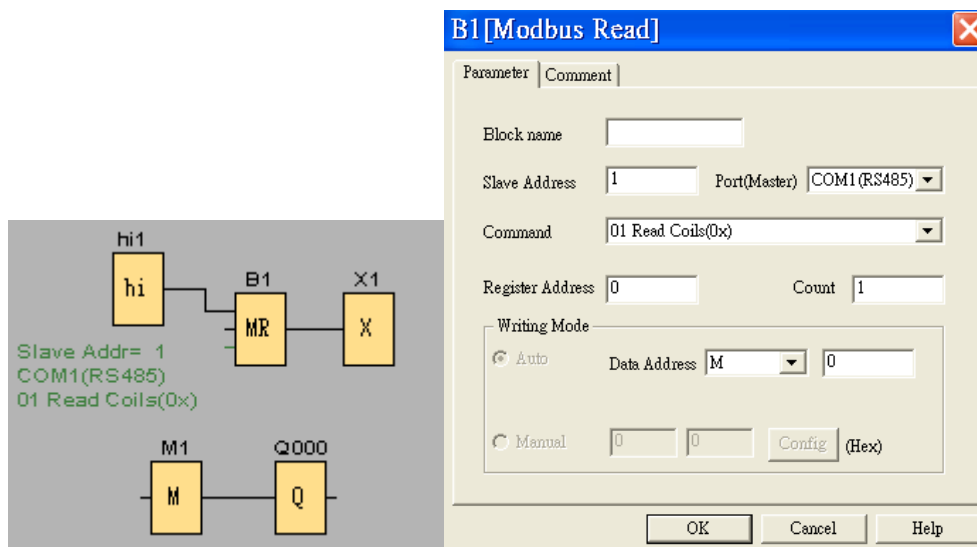

- A. For example, controller receive A-1060's input (8DI,4DO)
- B. hi1 block will enable B1 MR block, and transfer A-1060's input data to the controller
- C. The MR block parameter setting as below:
 - a. Slave Address: 1, All of Yottacontrol products' initial ID Address is 1. Controller's RS-485 port can connect to 255 units MODBUS devices. If you would like to connect more than 2 units devices at the same port, please set the different ID address for each device.
 - b. Port: COM1, set which com port would like to connect to other MODBUS device.
 - c. Command: 01 Read Coils, setting input command.
 - d. Register Address: 0, fill in Remote IO Module's input address. (**Note, A series Remote IO Module input address start from 0**)
 - e. Count: 1, fill in quantity of input control
 - f. Data Address: M1, M1 block will store Remote IO Module's input data, the controller will via MR block to read M1 data.

3.17 Message Text

A series Controller can via display or ATP (A series Text Panel) to monitor real-time value

Example: design a counter program and via ATP to display the current count value and the current time.

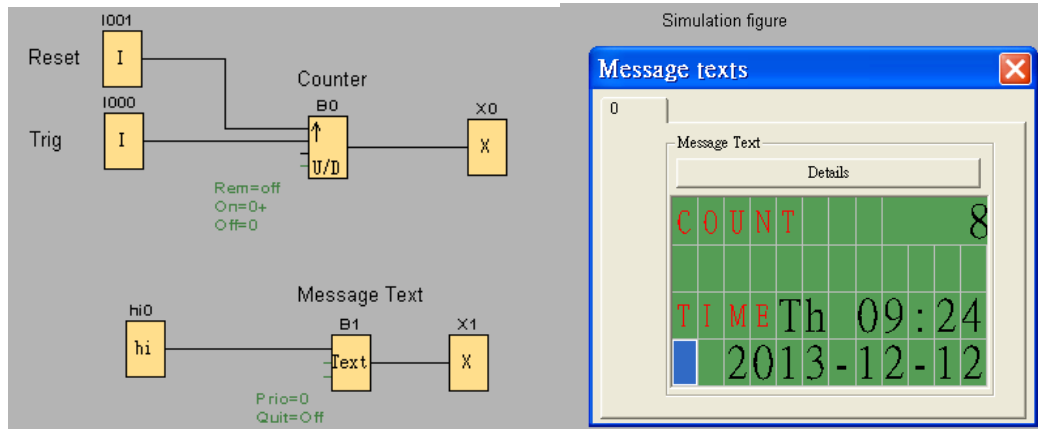

Indication:

1. If ATP via COM1 to connect Controller, please set COM1 as ATP as below:
 - a. Options -> Properties -> COM1
 - b. Choose Model as ATP
 - c. Click OK
2. This example is for Counter application, so place B0 counter block in the program
3. IO is for trig counter, I1 is for reset counter
4. For program rule, B0 block must connect a block, so place X0 open connector behind B0 count block
5. hi0 block for trig B1 Message Text block, B1 block's parameter setting as below figure

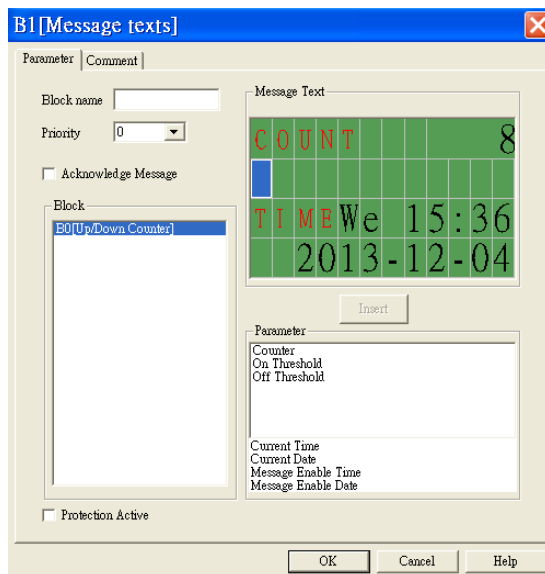

3.18 Controller display and ATP (text panel) menu structure

Depend on controller's switch status (Init/Normal), the display will show below figure, and can via button to complete below setting.

Note: at Init mode, press ESC more than 3 Sec can modify the parameter, when complete press OK more than 3 Sec to store the setting.

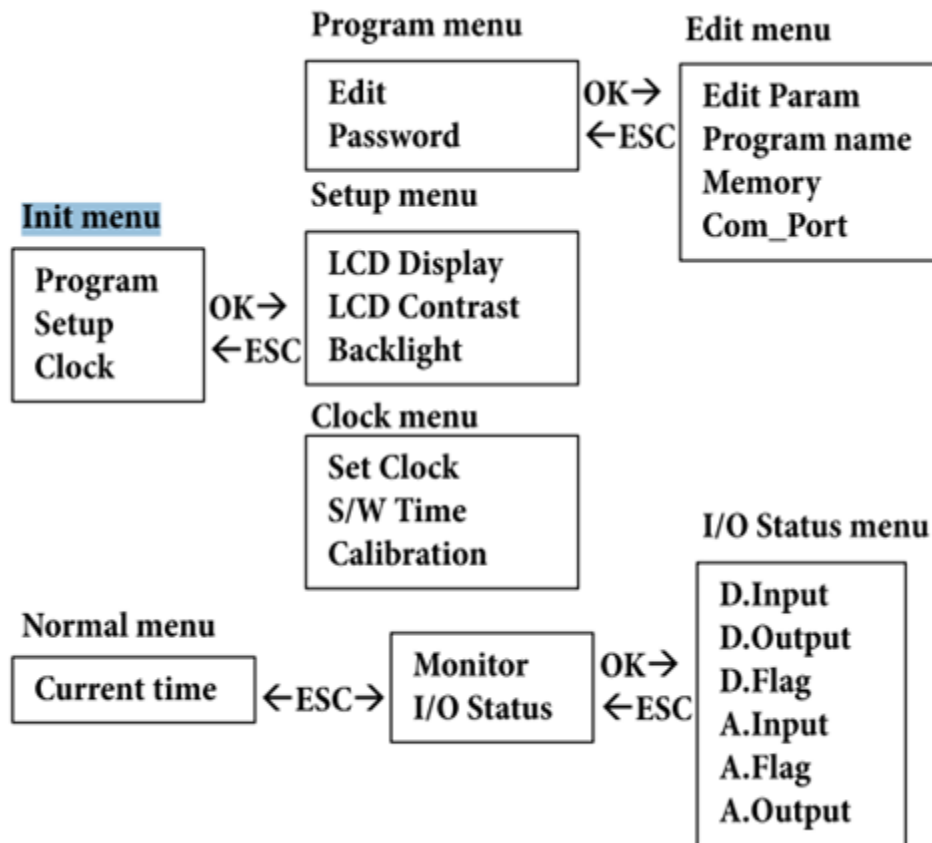

If would like to modify the program parameter

1. Turn controller switch to Init mode.
2. Choose Program -> Edit -> Edit Param
3. Display will show related block parameter, can use UP DOWN button to select the block, and press OK more than 3 Sec to modify.
4. When complete press OK more than 3 Sec to store the setting.

If would like to monitor controller's IO status

1. Turn controller switch to Normal mode.
2. Display will show current time. Press ESC.
3. If choosing Monitor, can monitor all blocks' status and parameters.
If choosing I/O status, can monitor Input, Output and Flag's status. In the figure, D is mean Digital, A is mean Analog.

3.19 Controller application wiring

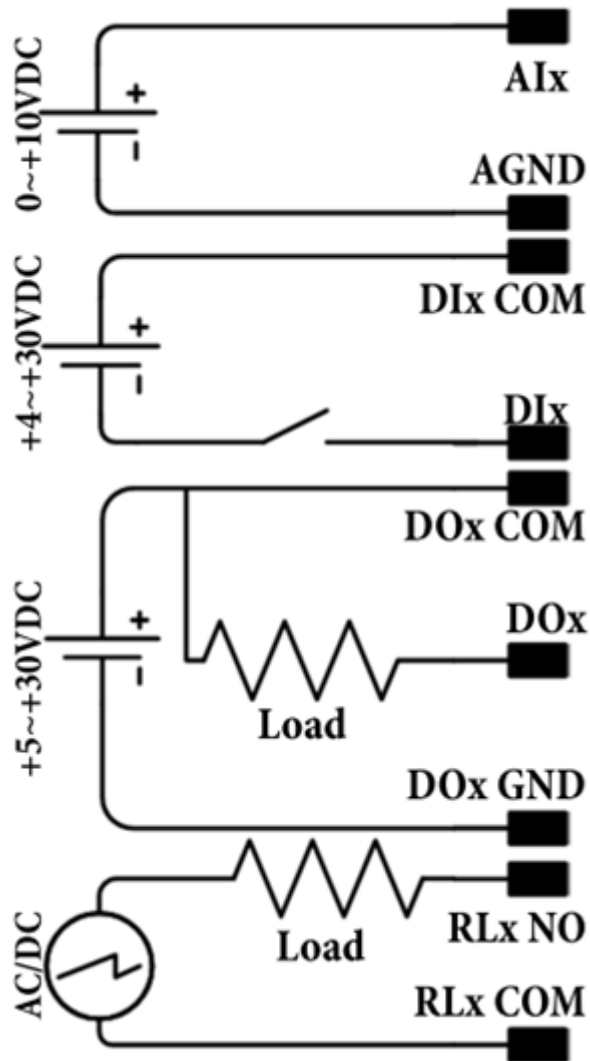

3.20 Controller POWER/RUN LED indicator

1. Red: Initial mode
2. Green: Normal (run) mode
3. Spark: no program in controller

3.21 Controller memory card



AMB is the memory card of A series Controller, not only offer convenience function, but also offer stable protection.

1. If would like download PC program into an AMB memory card, can refer [3.9 PC->Device](#)
2. If would like upload AMB memory card program to PC, can refer [3.10 Device->PC](#)
3. Plug AMB memory card which has program on the empty program Controller's slot, then press AMB DOWNLOAD more than 3 Sec, can download the AMB program to the Controller.
4. Plug empty program AMB on the Controller slot which has program, then press UPLOAD more than 3 Sec, can upload the Controller program to the AMB.
5. If would like to use AMB protection function, and when un-plug the AMB cause the Controller will out of work (empty program). Before download the program into to AMB, can refer [3.3 Properties-Parameter](#) to keyin the password, and refer [3.4 Properties-Protect](#) to choose Copy Protect.
6. AMB memory card LED indicator,
 - A. ERR : When program failed or upload process, ERR will spark.
 - B. PRG : When AMB have program will display Green, if the program have copy protection will display Red.
 - C. PWR : When power on the AMB, will display Green.

3.22 Address Mapping

Supported Modbus Code: 01/02/05/15 (Readable & Writable in Normal Mode)

Address	Description	R/W	Note
00001 ~ 00032	Main Digital Input Value (I000 ~ I031)	R	(0/1)
00033 ~ 00064	Ext1 Digital Input Value (I100 ~ I131)	R	(0/1)
00065 ~ 00096	Ext2 Digital Input Value (I200 ~ I231)	R	(0/1)
00097 ~ 00128	Ext3 Digital Input Value (I300 ~ I331)	R	(0/1)
00129 ~ 00160	Ext4 Digital Input Value (I400 ~ I431)	R	(0/1)
00161 ~ 00192	Ext5 Digital Input Value (I500 ~ I531)	R	(0/1)
00193 ~ 00224	Ext6 Digital Input Value (I600 ~ I631)	R	(0/1)
00225 ~ 00256	Ext7 Digital Input Value (I700 ~ I731)	R	(0/1)
00257 ~ 00272	Main Digital Output Value (Q000 ~ Q016)	R	(0/1)
00273 ~ 00288	EXT1 Digital Output Value (Q100 ~ Q116)	R	(0/1)
00289 ~ 00304	EXT2 Digital Output Value (Q200 ~ Q216)	R	(0/1)
00305 ~ 00320	EXT3 Digital Output Value (Q300 ~ Q316)	R	(0/1)
00321 ~ 00336	EXT4 Digital Output Value (Q400 ~ Q416)	R	(0/1)
00337 ~ 00352	EXT5 Digital Output Value (Q500 ~ Q516)	R	(0/1)
00353 ~ 00368	EXT6 Digital Output Value (Q600 ~ Q616)	R	(0/1)
00369 ~ 00384	EXT7 Digital Output Value (Q700 ~ Q716)	R	(0/1)
00385 ~ 00896	0~511 Digital Flag (M0 ~ M511)	R	(0/1)
00897 ~ 00912	0~15 Shift register bit (S0 ~ S15)	R	(0/1)
00913	Flag of SCAN Time	R	(0/1)
01025 ~ 01056	Main Digital Input Force ON (I000 ~ I031)	R/W	(0/1)
01057 ~ 01088	Ext1 Digital Input Force ON (I100 ~ I131)	R/W	(0/1)
01089 ~ 01120	Ext2 Digital Input Force ON (I200 ~ I231)	R/W	(0/1)
01121 ~ 01152	Ext3 Digital Input Force ON (I300 ~ I331)	R/W	(0/1)
01153 ~ 01184	Ext4 Digital Input Force ON (I400 ~ I431)	R/W	(0/1)
01185 ~ 01216	Ext5 Digital Input Force ON (I500 ~ I531)	R/W	(0/1)
01217 ~ 01248	Ext6 Digital Input Force ON (I600 ~ I631)	R/W	(0/1)
01249 ~ 01280	Ext7 Digital Input Force ON (I700 ~ I731)	R/W	(0/1)

01281 ~ 01312	Main Digital Input Force OFF (I000 ~ I031)	R/W	(0/1)
01313 ~ 01344	Ext1 Digital Input Force OFF (I100 ~ I131)	R/W	(0/1)
01345 ~ 01376	Ext2 Digital Input Force OFF (I200 ~ I231)	R/W	(0/1)
01377 ~ 01408	Ext3 Digital Input Force OFF (I300 ~ I331)	R/W	(0/1)
01409 ~ 01440	Ext4 Digital Input Force OFF (I400 ~ I431)	R/W	(0/1)
01441 ~ 01472	Ext5 Digital Input Force OFF (I500 ~ I531)	R/W	(0/1)
01473 ~ 01504	Ext6 Digital Input Force OFF (I600 ~ I631)	R/W	(0/1)
01505 ~ 01536	Ext7 Digital Input Force OFF (I700 ~ I731)	R/W	(0/1)

Supported Modbus Code: 01/02 (Readable in Normal Mode)

Address	Description	R/W	Note
02001~02004	Status of Function Block B0	R	
02005~02008	Status of Function Block B1	R	
02009~02012	Status of Function Block B2	R	
.....			
06093~06096	Status of Function Block B1023	R	

Supported Modbus Code: 03/04 (Readable in Normal Mode)

Address	Description	R/W	Note
40001	Com0 model	R	0x00 : Slave 0x01 : Master
40002	Com0 protocol	R	0x00 : RTU 0x01 : ASCII
40003	Com0 device address	R	1~255
40004	Com0 baud rate	R	0x00 : 1200 0x01 : 2400 0x02 : 4800 0x03 : 9600 0x04 : 14400 0x05 : 19200 0x06 : 28800 0x07 : 38400 0x08 : 57600 0x09 : 115200
40005	Com0 parity	R	0x00 : None 0x01 : Odd 0x02 : Even
40006	Com0 data bit	R	0x00 : 7-bit 0x01 : 8-bit

40007	Com0 stop bit	R	0x00 : 1-bit 0x01 : 2-bit
40008	Com0 timeout	R	50 ~ 65535 ms
40009	Com0 delay between polls	R	0 ~ 65535 ms
40010	Com0 data register index	R	0x00 : High Low 0x01:Low High
40011	Com0 status flag	R	
40012	Com1 model	R	0x00 : Slave 0x01: Master
40013	Com1 protocol	R	0x00 : RTU 0x01 : ASCII
40014	Com1 device address	R	1~255
40015	Com1 baud rate	R	0x00 : 1200 0x01 : 2400 0x02 : 4800 0x03 : 9600 0x04 : 14400 0x05 : 19200 0x06 : 28800 0x07 : 38400 0x08 : 57600 0x09 : 115200
40016	Com1 parity	R	0x00 : None 0x01 : Odd 0x02 : Even
40017	Com1 data bit	R	0x00 : 7-bit 0x01 : 8-bit
40018	Com1 stop bit	R	0x00 : 1-bit 0x01 : 2-bit
40019	Com1 timeout	R	50 ~ 65535 ms
40020	Com1 delay between polls	R	0 ~ 65535 ms
40021	Com1 data register index	R	0x00 : High Low 0x01:Low High
40022	Com1 status flag	R	
40023	Com2 model	R	0x00 : Slave 0x01 : Master
40024	Com2 protocol	R	0x00 : RTU 0x01 : ASCII
40025	Com2 device address	R	1~255
40026	Com2 baud rate	R	0x00 : 1200 0x01 : 2400 0x02 : 4800 0x03 : 9600 0x04 : 14400 0x05 : 19200 0x06 : 28800 0x07 :

			38400 0x08 : 57600 0x09 : 115200
40027	Com2 parity	R	0x00 : None 0x01 : Odd 0x02 : Even
40028	Com2 data bit	R	0x00 : 7-bit 0x01 : 8-bit
40029	Com2 stop bit	R	0x00 : 1-bit 0x01 : 2-bit
40030	Com2 timeout	R	50 ~ 65535 ms
40031	Com2 delay between polls	R	0 ~ 65535 ms
40032	Com2 data register index	R	0x00 : High Low 0x01:Low High
40033	Com2 status flag	R	

Supported Modbus Code: 03/04 (Readable in Normal Mode)

Address	Description	R/W	Note
40211	Module Name 1	R	118X Ex:0x1188
40212	Module Name 2	R	0x0000
40213	Firmware Version 1	R	A1.00 Ex:0xA100
40214	Firmware Version 2	R	0x0000
40215	Mac Serial Number 1	R	
40216	Mac Serial Number 2	R	
40217	Mac Serial Number 3	R	
40218	Mac Serial Number 4	R	
40219	Mac Serial Number 5	R	
40220	Mac Serial Number 6	R	
40221	Redundancy condition	R	0x00: None 0x01:Master 0x02:Slave
40222	Redundancy operating time (low word) (ms)	R	0x0000 ~ 0xFFFF
40223	Redundancy operating time (high word) (ms)	R	0x0000 ~ 0xFFFF
40224	LCM Control Register	R	
40225	Machine internal temperature	R	-32768 ~ 32767

	(degree Celsius)		
40226	Controller Fault Status	R	
40227	System Status 1	R	
40228	System Status 2	R	
40229	Scan Cycle Time (ms)	R	1 ~ 65535
40230	Redundancy status	R	0x00 : stop 0x01: standby 0x02: action
40231	Power On Hours (hr)	R	0~65535
40232	COM0 communication success rate (times/min)	R	0~65535
40233	COM0 communication error rate (times/min)	R	0~65535
40234	COM1 communication success rate (times/min)	R	0~65535
40235	COM1 communication error rate (times/min)	R	0~65535
40236	COM2 communication success rate (times/min)	R	0~65535
40237	COM2 communication error rate (times/min)	R	0~65535
40238	COM3 communication success rate (times/min)	R	0~65535
40239	COM3 communication error rate (times/min)	R	0~65535
40240	COM4 communication success rate (times/min)	R	0~65535
40241	COM4 communication error rate (times/min)	R	0~65535
40242	COM5 communication success rate (times/min)	R	0~65535
40243	COM5 communication error rate (times/min)	R	0~65535
40244	COM6 communication success	R	0~65535

	rate (times/min)		
40245	COM6 communication error rate (times/min)	R	0~65535
40246	COM7 communication success rate (times/min)	R	0~65535
40247	COM7 communication error rate (times/min)	R	0~65535
40248	Downloading number of times	R	0~65535
40249	History Temperature_min (degree Celsius)	R	-32768 ~ 32767
40250	History Temperature_max (degree Celsius)	R	-32768 ~ 32767
40251	High temperature protection point	R	-32768 ~ 32767
40252	Low temperature protection point	R	-32768 ~ 32767
40253	Power On Count (low word)	R	0x0000 ~ 0xFFFF
40254	Power On Count (high word)	R	0x0000 ~ 0xFFFF
40255	DOWNLOAD_STATUS	R	0x00 : normal 0x01 : fail
40256	Last shutdown time -Week_RTC	R	0 ~ 6
40257	Last shutdown time -Year_RTC	R	2010 ~ 2036
40258	Last shutdown time -Month_RTC	R	1 ~ 12
40259	Last shutdown time -Day_RTC	R	1 ~ 31
40260	Last shutdown time -Hour_RTC	R	0 ~ 23
40261	Last shutdown time -Min_RTC	R	0 ~ 59
40262	Last shutdown time -Sec_RTC	R	0 ~ 59
40263	RTC Calibrate sign	R	0: plus 1: minus
40264	RTC Calibrate value	R	0 ~ 30 (Sec/week)

Supported Modbus Code: 03/04 (Readable in Normal Mode)

Address	Description	R/W	Note
40301	Week_RTC	R	0 ~ 6
40302	Year_RTC	R	2010 ~ 2036
40303	Month_RTC	R	1 ~ 12
40304	Day_RTC	R	1 ~ 31
40305	Hour_RTC	R	0 ~ 23
40306	Min_RTC	R	0 ~ 59
40307	Sec_RTC	R	0 ~ 59

Supported Modbus Code: 03/04 (Readable in Normal Mode)

Address	Description	R/W	Note
40501 ~ 40508	Main Analog Input Value (AI000 ~ AI007)	R	
40509 ~ 40516	EXT1 Analog Input Value (AI100 ~ AI107)	R	
40517 ~ 40524	EXT2 Analog Input Value (AI200 ~ AI207)	R	
40525 ~ 40532	EXT3 Analog Input Value (AI300 ~ AI307)	R	
40533 ~ 40540	EXT4 Analog Input Value (AI400 ~ AI407)	R	
40541 ~ 40548	EXT5 Analog Input Value (AI500 ~ AI507)	R	
40549 ~ 40556	EXT6 Analog Input Value (AI600 ~ AI607)	R	
40557 ~ 40564	EXT7 Analog Input Value (AI700 ~ AI707)	R	
40565 ~ 40568	Main Analog Output Value (AQ000 ~ AQ003)	R	
40569 ~ 40572	EXT1 Analog Output Value (AQ100 ~ AQ103)	R	
40573 ~ 40576	EXT2 Analog Output Value (AQ200 ~ AQ203)	R	
40577 ~ 40580	EXT3 Analog Output Value (AQ300 ~ AQ303)	R	
40581 ~ 40584	EXT4 Analog Output Value (AQ400 ~ AQ403)	R	
40585 ~ 40588	EXT5 Analog Output Value (AQ500 ~ AQ503)	R	
40589 ~ 40592	EXT6 Analog Output Value (AQ600 ~ AQ603)	R	
40593 ~ 40596	EXT7 Analog Output Value (AQ700 ~ AQ703)	R	
40597 ~ 41108	0 ~ 511 Analog Flag Value (AM0 ~ AM511)	R	

Supported Modbus Code: 03/04 (Readable in Normal Mode)

Address	Description	R/W	Note
42001~42004	Parameter of Function Block B0	R	
42005~42008	Parameter of Function Block B1	R	
42009~42012	Parameter of Function Block B2	R	
.....			
46093~46096	Parameter of Function Block B1023	R	

More Information

Block Type	Address 1	Address 2	Address 3	Address 4
AND	Block Output (0xxxx)	X	X	X
AND (Edge)	Block Output (0xxxx)	X	X	X
NAND	Block Output (0xxxx)	X	X	X
NAND (Edge)	Block Output (0xxxx)	X	X	X
OR	Block Output (0xxxx)	X	X	X
NOR	Block Output (0xxxx)	X	X	X
XOR	Block Output (0xxxx)	X	X	X
NOT	Block Output (0xxxx)	X	X	X
On-Delay	Block Output (0xxxx)	X	Timer (4xxxx)	X
Off-Delay	Block Output (0xxxx)	X	Timer (4xxxx)	X
On-/Off-Delay	Block Output (0xxxx)	X	Timer (4xxxx)	X
Retentive On-Delay	Block Output (0xxxx)	X	Timer (4xxxx)	X
Wiping relay (pulse output)	Block Output (0xxxx)	X	Timer (4xxxx)	X
Edge triggered wiping relay	Block Output (0xxxx)	X	Timer (4xxxx)	X
Asynchronous Pulse Generator	Block Output (0xxxx)	X	Timer (4xxxx)	X
Random Generator	Block Output (0xxxx)	X	Timer (4xxxx)	X
Stairway lighting switch	Block Output (0xxxx)	X	Timer (4xxxx)	X

Multiple function switch	Block Output (0xxxx)	X	Timer (4xxxx)	X
Weekly Timer	Block Output (0xxxx)	X	X	X
Yearly Timer	Block Output (0xxxx)	X	X	X
Up/Down counter	Block Output (0xxxx)	X	Count Value (l) (4xxxx)	Count Value (h) (4xxxx)
Hours Counter	Block Output (0xxxx)	X	MN Value (l) (4xxxx)	MN Value (h) (4xxxx)
Threshold trigger	Block Output (0xxxx)	X	Count Value (l) (4xxxx)	Count Value (h) (4xxxx)
Analog Comparator	Block Output (0xxxx)	X	Actual values(Ax-Ay) (l) (4xxxx)	Actual values(Ax-Ay) (h) (4xxxx)
Analog threshold trigger	Block Output (0xxxx)	X	Actual value Ax (l) (4xxxx)	Actual value Ax (h) (4xxxx)
Analog Amplifier	Block Output (4xxxx)	X	Actual value Ax (l) (4xxxx)	Actual value Ax (h) (4xxxx)
Analog watchdog	Block Output (0xxxx)	Actual value Aen (4xxxx)	Actual value Ax (l) (4xxxx)	Actual value Ax (h) (4xxxx)
Analog differential trigger	Block Output (0xxxx)	X	Actual value Ax (l) (4xxxx)	Actual value Ax (h) (4xxxx)
Latching Relay	Block Output (0xxxx)	X	X	X
Pulse Relay	Block Output (0xxxx)	X	X	X
Message texts	Block Output (0xxxx)	X	X	X
Shift register	Block Output (0xxxx)	X	Register Value (4xxxx)	X
Modbus Read	Block Output (0xxxx)	Count (4xxxx)	Data Address (4xxxx)	X
Modbus Write	Block Output (0xxxx)	Count (4xxxx)	Data1 (Manual) / Data Address (Auto) (4xxxx)	Data2 (Manual) (4xxxx)

3.23 Example applications

3.23.1 Dual counter

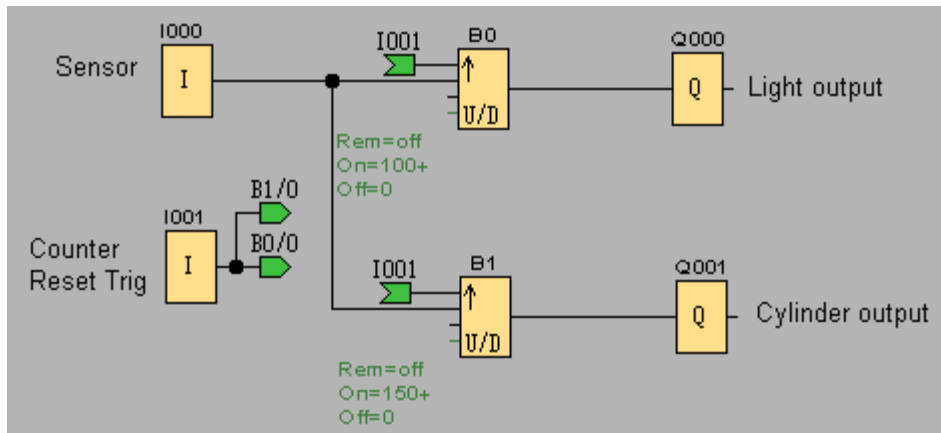

Process describing:

For example, the sensor use for receiving data and count, when the counter value is 100, the light output. When counter value is 150, the cylinder output.

3.23.2 School bell system

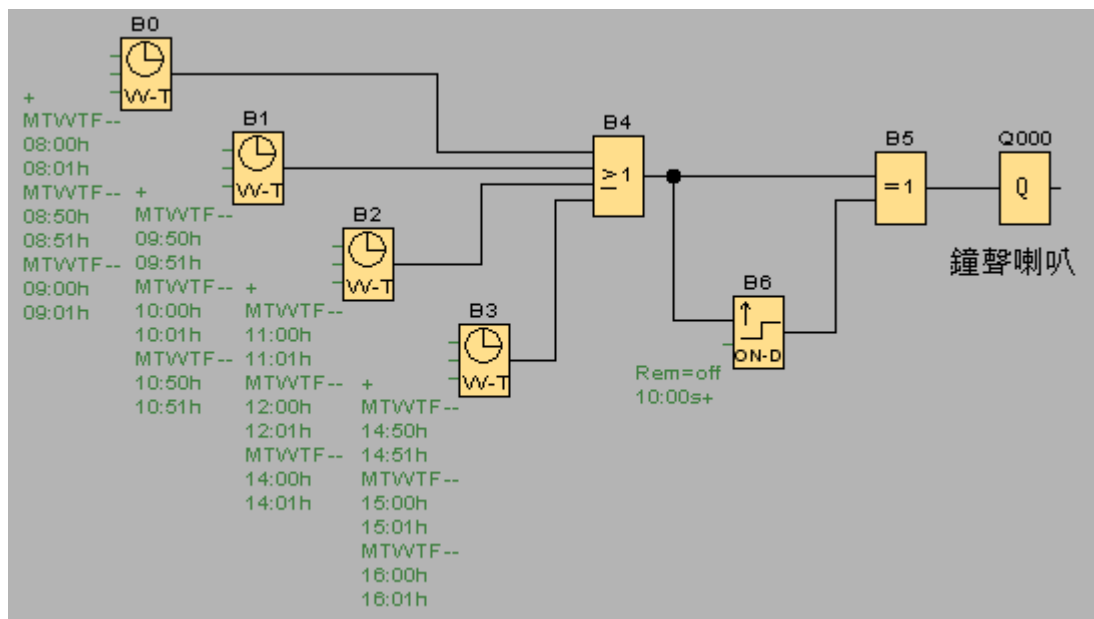

Process describing:

When school begins, break and end, the bell will ring 10 seconds on setting time. Bell time is set on Monday to Friday at 8:00, 8:50, 9:00, 9:50, 10:00, 10:50, 11:00, 12:00, 14:00, 14:50, 15:00 and 16:00.

3.23.3 Redundant (Master and Slave controller)

In some special application or territory, we don't allow the controller out of work. We can via Redundant function to solve this problem. When Master Controller out of work, Slave Controller will instead Master. If Master Controller reinstate, will still operate and Slave Controller stand by.

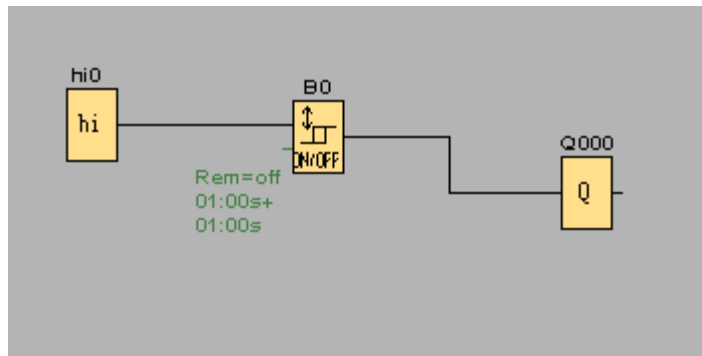

For example, the Master Controller program is as above figure.

This application is control DO 0: ON 1 Sec, OFF 1 Sec. Via COM1 to communicate with Slave PLC. So set the COM1 as Slave.

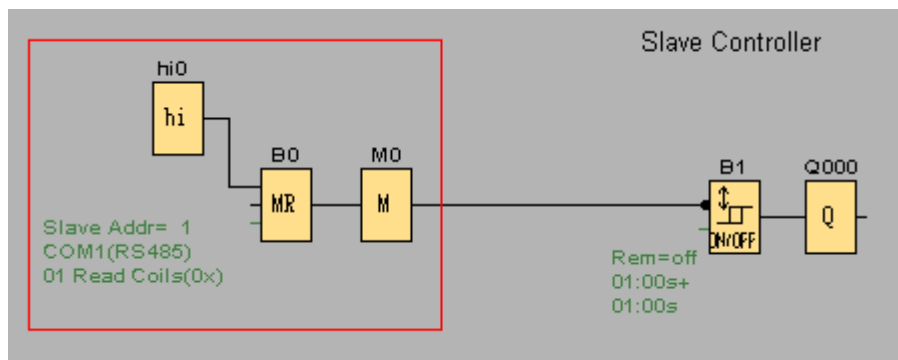

Slave PLC

You can copy all the program from the Master, and paste here. Via COM1 to communicate with Master Controller. Now should edit some program from Master Controller.

It adds hi0, B0 and M0 blocks

B0 block parameter please refer this block

B1 Timer block's input must use invert, you can detect there is a black point ahead the block

B0 output conditional is as below:

Q is set or reset depending on the communication status.

Q=1, if the communication is successful

Q=0, if the communication is failed

4 . YottaUtility overview

4.1 Main screen

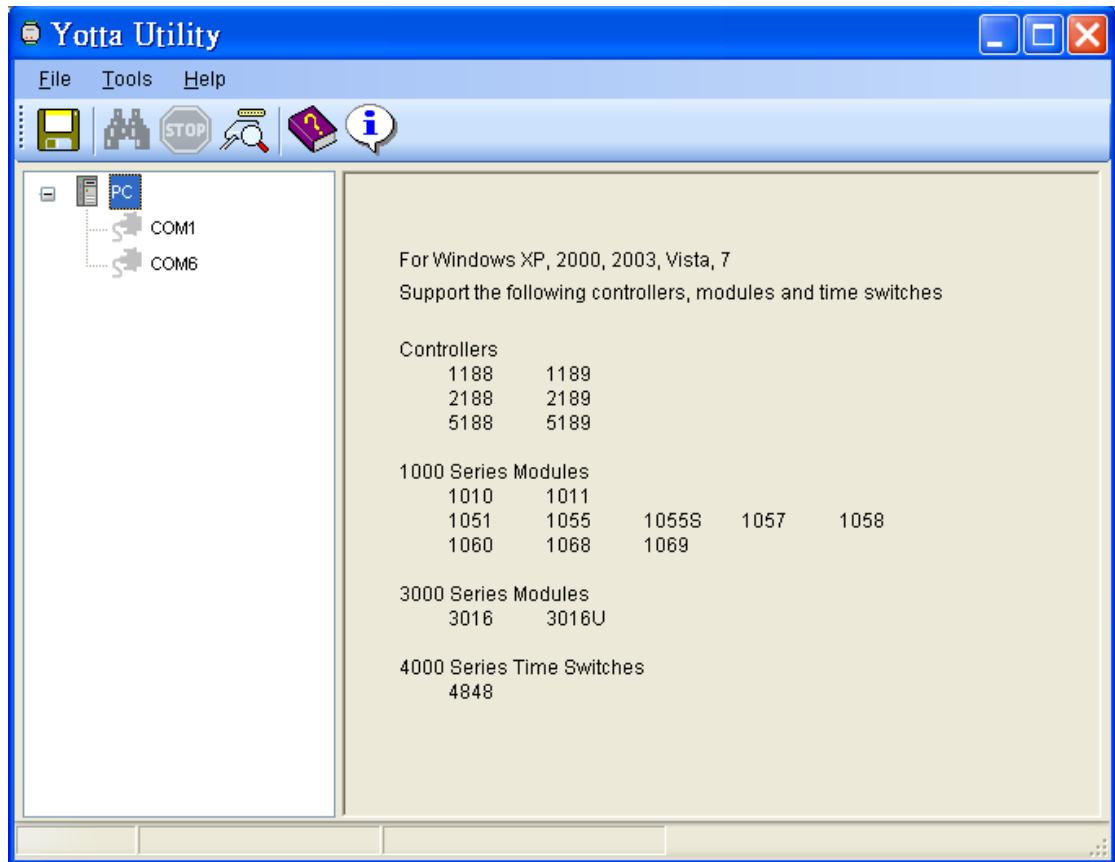

4.2 The controller communicates with the PC

We can refer [2.1 Controller communicate to PC](#) to complete it.

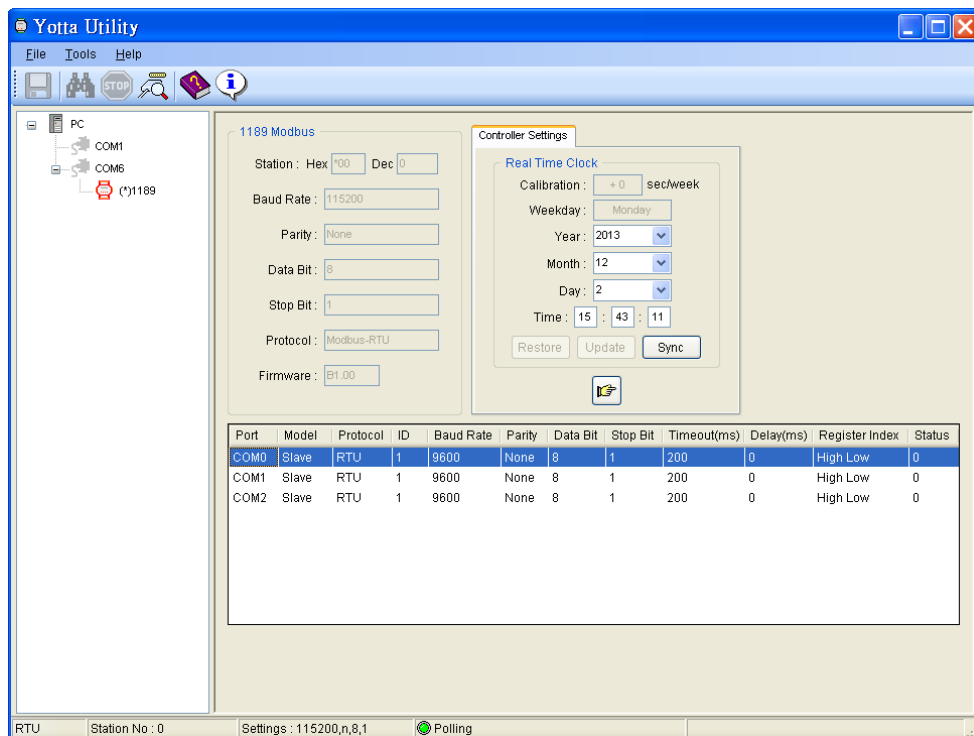

4.2.1 Initial mode

When turn the controller switch to Init mode, you can see the following figure.

1188 Modbus

Station : Hex Dec

Baud Rate :

Parity :

Data Bit :

Stop Bit :

Protocol :

Firmware :

Controller Settings

Real Time Clock

Calibration : sec/week

Weekday :

Year :

Month :

Day :

Time : : :



Port	Model	Protocol	ID	Baud Rate	Parity	Data Bit	Stop Bit	Timeout(ms)	Delay(ms)	Register Index	Status
COM0	Master	RTU	1	9600	None	8	1	200	0	High Low	0
COM1	Master	RTU	1	9600	None	8	1	200	0	High Low	0
COM2	Slave	ASCII	6	115200	Even	7	2	200	0	High Low	0

4.2.1.1 General setting

The general settings are read only.

Station : Hex Dec

Baud Rate :

Parity :

Data Bit :

Stop Bit :

Protocol :

Firmware :

4.2.1.2 Real Time Clock

Real Time Clock

Calibration : + 0 sec/week

Weekday : Thursday

Year : 2012

Month : 11

Day : 22

Time : 16 : 21 : 06

Restore Update Sync

- *Calibration and Weekday are read only.
- *You can set Year, Month, Day and Time. Press the Update button to store the changed values.
- *Press the Restore button to restore the RTC value from the controller's memory.
- *The Update and Restore buttons are available when the Weekday or Time values are changed.
- *Press the Sync button to synchronize the RTC time with a PC.

4.2.1.3 More information

Can press  to realize more controller information.

4.2.2 Normal mode

When turn the controller switch to Normal mode, you can see the following figure.

1188 Modbus

Station : Hex 09 Dec 9

Baud Rate : 115200

Parity : Even

Data Bit : 7

Stop Bit : 2

Protocol : Modbus-ASCII

Firmware : B1.00

Controller Settings

Real Time Clock

Calibration : + 0 sec/week

Weekday : Thursday

Year : 2012

Month : 11

Day : 22

Time : 16 : 21 : 06

Restore Update Sync

Port	Model	Protocol	ID	Baud Rate	Parity	Data Bit	Stop Bit	Timeout(ms)	Delay(ms)	Register Index	Status
COM0	Master	RTU	1	9600	None	8	1	200	0	High Low	0
COM1	Master	RTU	1	9600	None	8	1	200	0	High Low	0
COM2	Slave	ASCII	6	115200	Even	7	2	200	0	High Low	0

4.3 More Information

When the button  is pressed, you can see the following figure. The below figure includes 4 tabs: [Controller Information](#), [Database](#), [Historical Trends](#) and [Realtime Trends](#).

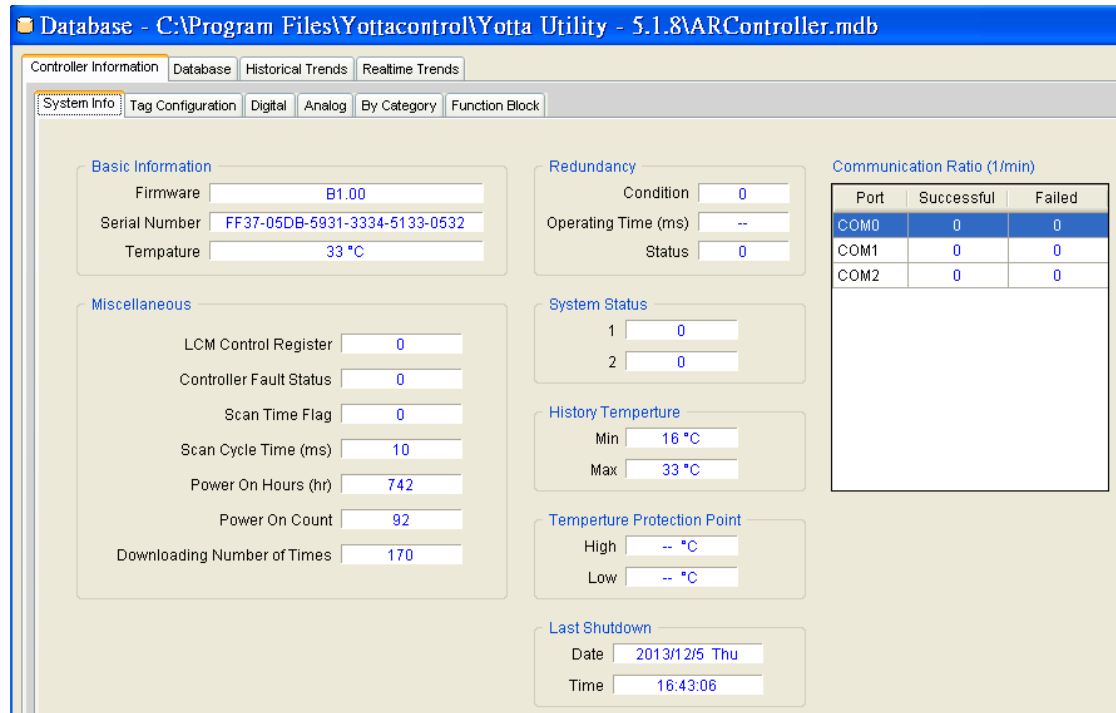

4.3.1 Controller Information

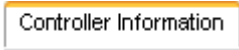
When the tab on the upper tabs is switched to , you can see the figure below. The figure below includes 6 tabs: [System Info](#), [Tag Configuration](#), [Digital](#), [Analog](#), [By Category](#) and [Function Block](#).

4.3.2 System Info

This page lets you get a deep view of the information and status of the controller. The data read from the controller provide the information and status. The label on the left side of each data indicates the meaning of each data.

4.3.3 Tag Configuration







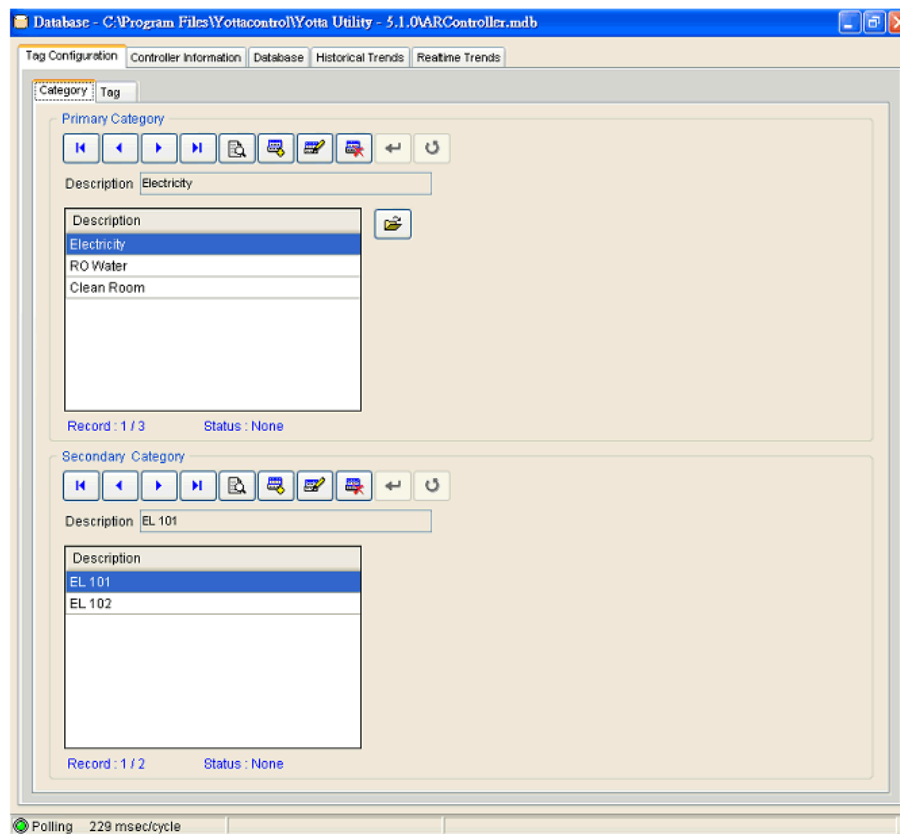



This tab contains 2 sub-tabs Category and Tag.

The controller contains lots of digital/analog inputs/outputs and flags. This section introduces you how to give useful information for each I/O and flag. A factory or manufacturing plant usually consists of buildings and equipment. It's possible that workers in factory need to handle many facilities such as electricity, gas, water, clean room and so on.

4.3.3.1 Category



Here is an example, electricity facility includes 2 electric panels : EL101 and EL102. Users can define them in Primary Category and Secondary Category respectively. By the same token, users can define RO water, clean room and other facilities etc.

	Go to the first record.		Update a record.
	Go to the previous record.		Delete a record.
	Go to the next record.		Confirm the operation.
	Go to the last record.		Cancel the operation.
	Query records.		Note : Users can use this button to import the following settings from an existing ARControllerYYMMDD.mdb file. <ol style="list-style-type: none"> 1. Primary / Secondary Category and Tags. 2. Historical Trends. 3. Realtime Trends.
	Add a record.		

4.3.3.2 Tag

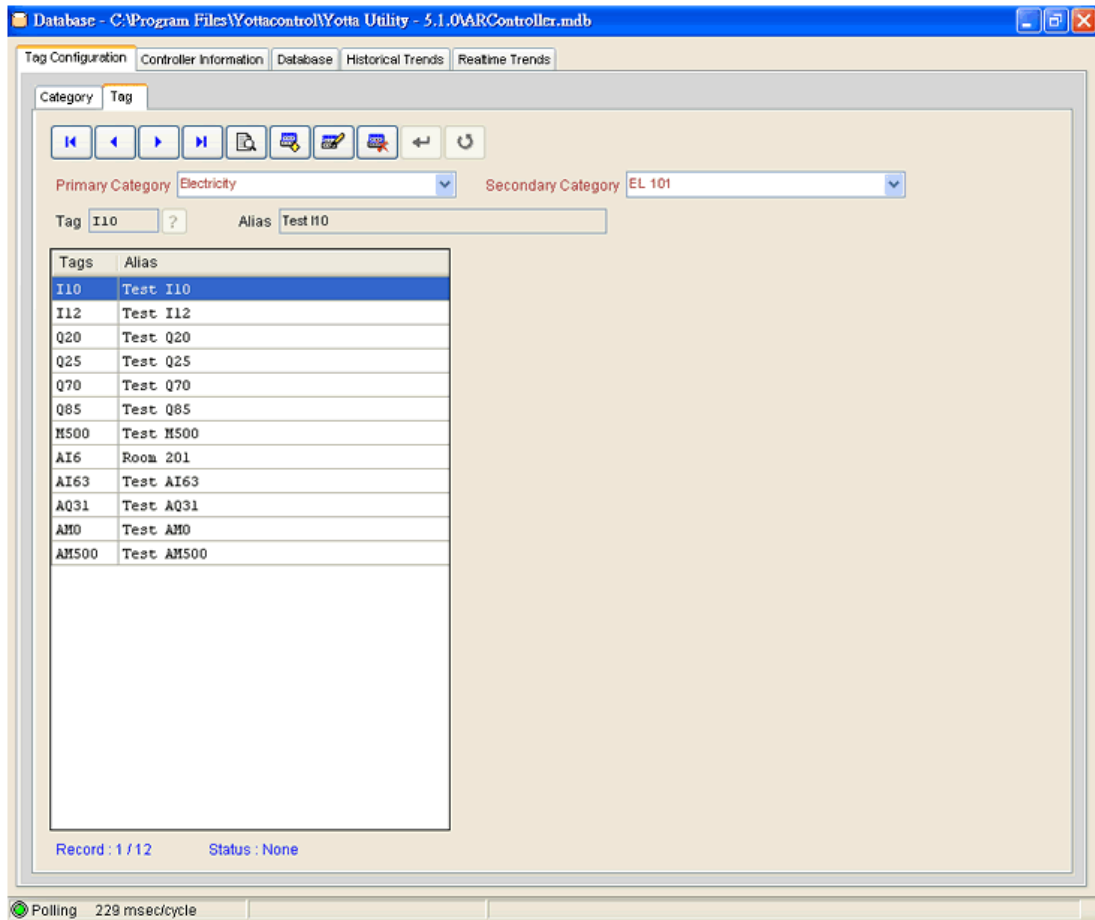

The instructions of field **Tag**, **Alias** and button  are as follows:

Tag	Specify the I/O channel.
Alias	The detailed information of the tag.
	Show the formats of tags. 1. Digital Input : I0 ~ I255. 2. Digital Output : Q0 ~ Q127. 3. Digital Flag : M0 ~ M511. 4. Analog Input : AI0 ~ AI63. 5. Analog Output : AQ0 ~ AQ31. 6. Analog Flag : AM0 ~ AM511.

4.3.4 Digital

This page provides the detailed information of digital signals, such as inputs, outputs, flags and shift registers.

Module	Tag	Value	Tag	Value	Tag	Value	Tag	Value	Tag	Value	Tag	Value	Tag	Value	Tag	Value
Main	I0	0	I1	0	I2	0	I3	0	I4	0	I5	0	I6	0	I7	0
Main	I8	0	I9	0	I10	0	I11	0	I12	0	I13	0	I14	0	I15	0
Main	I16	0	I17	0	I18	0	I19	0	I20	0	I21	0	I22	0	I23	0
Main	I24	0	I25	0	I26	0	I27	0	I28	0	I29	0	I30	0	I31	0
Ext. 1	I32	0	I33	0	I34	0	I35	0	I36	0	I37	0	I38	0	I39	0
Ext. 1	I40	0	I41	0	I42	0	I43	0	I44	0	I45	0	I46	0	I47	0
Ext. 1	I48	0	I49	0	I50	0	I51	0	I52	0	I53	0	I54	0	I55	0
Ext. 1	I56	0	I57	0	I58	0	I59	0	I60	0	I61	0	I62	0	I63	0
Ext. 2	I64	0	I65	0	I66	0	I67	0	I68	0	I69	0	I70	0	I71	0
Ext. 2	I72	0	I73	0	I74	0	I75	0	I76	0	I77	0	I78	0	I79	0
Ext. 2	I80	0	I81	0	I82	0	I83	0	I84	0	I85	0	I86	0	I87	0
Ext. 2	I88	0	I89	0	I90	0	I91	0	I92	0	I93	0	I94	0	I95	0
Ext. 3	I96	0	I97	0	I98	0	I99	0	I100	0	I101	0	I102	0	I103	0
Ext. 3	I104	0	I105	0	I106	0	I107	0	I108	0	I109	0	I110	0	I111	0
Ext. 3	I112	0	I113	0	I114	0	I115	0	I116	0	I117	0	I118	0	I119	0
Ext. 3	I120	0	I121	0	I122	0	I123	0	I124	0	I125	0	I126	0	I127	0
Ext. 4	I128	0	I129	0	I130	0	I131	0	I132	0	I133	0	I134	0	I135	0
Ext. 4	I136	0	I137	0	I138	0	I139	0	I140	0	I141	0	I142	0	I143	0
Ext. 4	I144	0	I145	0	I146	0	I147	0	I148	0	I149	0	I150	0	I151	0
Ext. 4	I152	0	I153	0	I154	0	I155	0	I156	0	I157	0	I158	0	I159	0
Ext. 5	I160	0	I161	0	I162	0	I163	0	I164	0	I165	0	I166	0	I167	0
Ext. 5	I168	0	I169	0	I170	0	I171	0	I172	0	I173	0	I174	0	I175	0

4.3.5 Analog

This page provides the detailed information of analog signals, such as inputs, outputs and flags.

Module	Tag	Value	Tag	Value	Tag	Value	Tag	Value	Tag	Value	Tag	Value	Tag	Value	Tag	Value
Main	AI0	0x0000	AI1	0x0000	AI2	0x0000	AI3	0x0000	AI4	0x0000	AI5	0x0000	AI6	0x0000	AI7	0x0000
Ext. 1	AI8	0x0000	AI9	0x0000	AI10	0x0000	AI11	0x0000	AI12	0x0000	AI13	0x0000	AI14	0x0000	AI15	0x0000
Ext. 2	AI16	0x0000	AI17	0x0000	AI18	0x0000	AI19	0x0000	AI20	0x0000	AI21	0x0000	AI22	0x0000	AI23	0x0000
Ext. 3	AI24	0x0000	AI25	0x0000	AI26	0x0000	AI27	0x0000	AI28	0x0000	AI29	0x0000	AI30	0x0000	AI31	0x0000
Ext. 4	AI32	0x0000	AI33	0x0000	AI34	0x0000	AI35	0x0000	AI36	0x0000	AI37	0x0000	AI38	0x0000	AI39	0x0000
Ext. 5	AI40	0x0000	AI41	0x0000	AI42	0x0000	AI43	0x0000	AI44	0x0000	AI45	0x0000	AI46	0x0000	AI47	0x0000
Ext. 6	AI48	0x0000	AI49	0x0000	AI50	0x0000	AI51	0x0000	AI52	0x0000	AI53	0x0000	AI54	0x0000	AI55	0x0000
Ext. 7	AI56	0x0000	AI57	0x0000	AI58	0x0000	AI59	0x0000	AI60	0x0000	AI61	0x0000	AI62	0x0000	AI63	0x0000

4.3.6 By Category

This page provides the information of digital/analog inputs/outputs and flags by primary and secondary category.

Digital Input		
Tag	Value	Alias

Digital Output		
Tag	Value	Alias

Digital Flag		
Tag	Value	Alias

4.3.7 Function Block

This page provides the detailed information of the function block. Please refer to the following table.

Block Type	Addr_ AIO (DIO) _1	Addr_ AIO (DIO) _2	Addr_ AIO (DIO) _3	Addr_ AIO (DIO) _4
AND	Block Output (0xxxx)	X	X	X
AND (Edge)	Block Output (0xxxx)	X	X	X
NAND	Block Output (0xxxx)	X	X	X
NAND (Edge)	Block Output (0xxxx)	X	X	X
OR	Block Output (0xxxx)	X	X	X
NOR	Block Output (0xxxx)	X	X	X
XOR	Block Output (0xxxx)	X	X	X
NOT	Block Output (0xxxx)	X	X	X
On-Delay	Block Output (0xxxx)	X	TMR (4xxxx)	X
Off-Delay	Block Output (0xxxx)	X	TMR (4xxxx)	X
On-/Off-Delay	Block Output (0xxxx)	X	TMR (4xxxx)	X
Retentive on-Delay	Block Output (0xxxx)	X	TMR (4xxxx)	X
Wiping relay (pulse output)	Block Output (0xxxx)	X	TMR (4xxxx)	X
Edge triggered wiping relay	Block Output (0xxxx)	X	TMR (4xxxx)	X
Asynchronous Pulse Generator	Block Output (0xxxx)	X	TMR (4xxxx)	X
Random Generator	Block Output (0xxxx)	X	TMR (4xxxx)	X
Stairway lighting switch	Block Output (0xxxx)	X	TMR (4xxxx)	X
Multiple function switch	Block Output (0xxxx)	X	TMR (4xxxx)	X
Weekly Timer	Block Output (0xxxx)	X	X	X
Yearly Timer	Block Output (0xxxx)	X	X	X
Up/Down counter	Block Output (0xxxx)	X	CNT (l) (4xxxx) (ref)	CNT (h) (4xxxx) (ref)
Hours Counter	Block Output (0xxxx)	X	MN (l) (4xxxx)	MN (h) (4xxxx)
Threshold trigger	Block Output (0xxxx)	X	CNT (l) (4xxxx)	CNT (h) (4xxxx)
Analog Comparator	Block Output (0xxxx)	X	Ad_buf = (Ax-Ay) (l) (4xxxx) (ref)	Ad_buf = (Ax-Ay) (h) (4xxxx) (ref)
Analog threshold trigger	Block Output (0xxxx)	X	Ad_buf (l) (4xxxx) (ref)	Ad_buf (h) (4xxxx) (ref)
Analog Amplifier	Block Output (4xxxx)	X	Ad_buf (l) (4xxxx) (ref) (same as output)	Ad_buf (h) (4xxxx) (ref)

Analog watchdog	Block Output (0xxxx)	Aen (4xxxx)	Ad_buf (l) (4xxxx)	Ad_buf (h) (4xxxx)
Analog differential trigger	Block Output (0xxxx)	X	Ad_buf (l) (4xxxx)	Ad_buf (h) (4xxxx)
Latching Relay	Block Output (0xxxx)	X	X	X
Pulse Relay	Block Output (0xxxx)	X	X	X
Message texts	Block Output (0xxxx)	X	X	X
Softkey	Block Output (0xxxx)	X	X	X
Shift register	Block Output (0xxxx)	X	X	X
Modbus Read	Block Output (0xxxx)	count (4xxxx)	Data_Add (4xxxx)	X
Modbus Write	Block Output (0xxxx)	count (4xxxx)	Data1 / Data_Add (4xxxx)	Data2 (4xxxx)

4.4 Database

When the tab on the upper tabs is switched to Database, you can see the figure below.

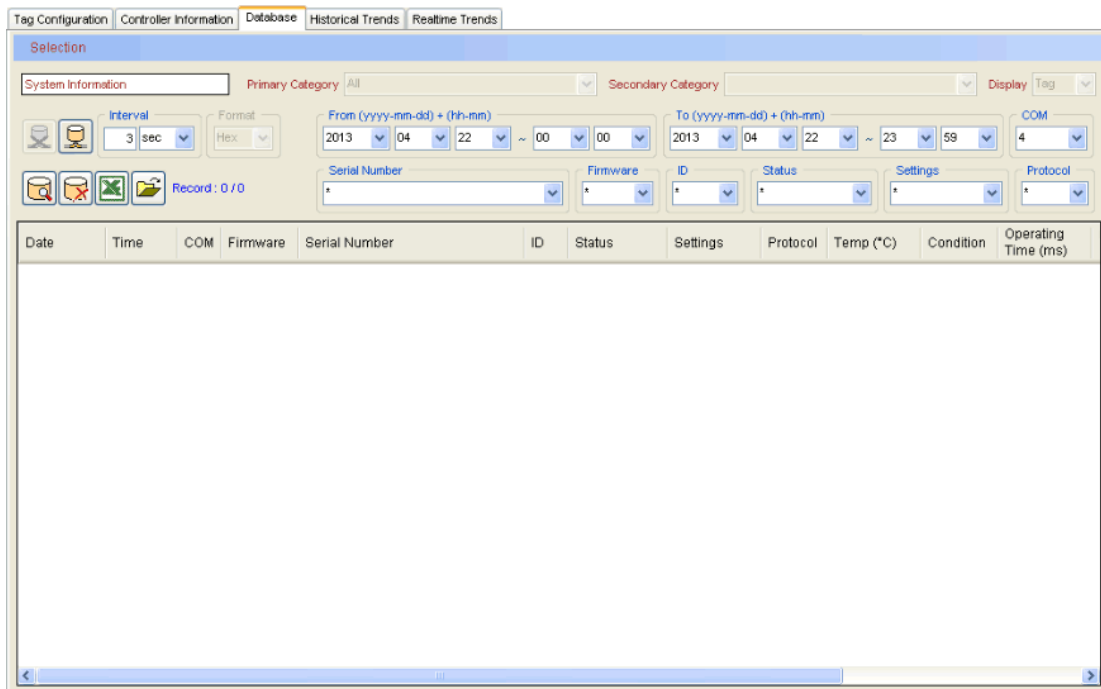



We provide users with database functions. Users can store the values of selected modules into the database. These data can be retrieved from the database for further analysis in the future.

Note : The database is a Microsoft Access file. The file name is `app_path\ARController.mdb`.

Note : The file backups automatically when its size exceeds 500 MB. The backup file name is `ARControllerYYYYMMDD.mdb`.

Note : The file `app_path\ARControllerTemplate.mdb` **should not be modified and deleted.**

The below instructions show you how to manipulate the database.





	Stop inserting data into the database.
	Inserting data into the database.
<input type="text" value="3"/> <input checked="" type="radio"/> sec <input type="radio"/> min	Specify the time interval for inserting data into the database.

How to Use the Database

In the previous figure, users can retrieve and delete data from the database. The combination of all drop-down boxes is the criteria for retrieving and deleting data.

Note : The star sign (*) in drop-down boxes means all.

Note : If the number of retrieving data is more than 3000. You have to reset the selection criteria.

	Retrieve data from the database.
	Delete data from the database.
	Export data to Excel.
	Close the form.

4.5 Historical Trends

When the tab on the upper tabs is switched to Historical Trends, you can see the figure below.

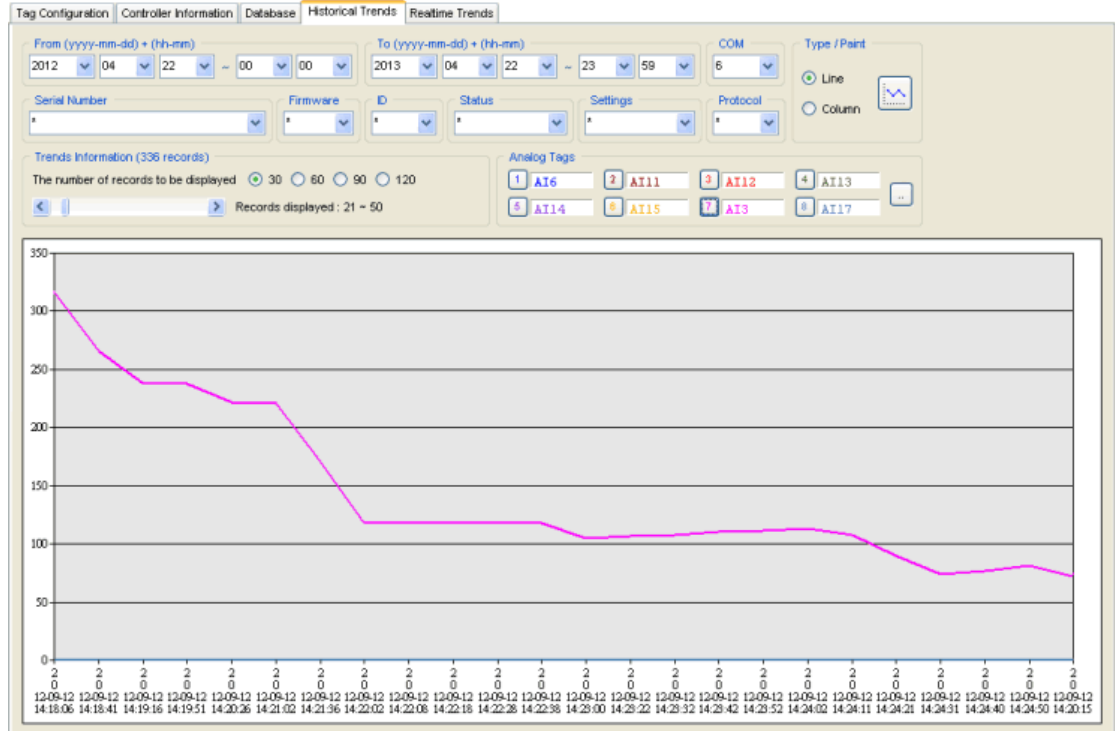

We provide users with historical trends. Users can analyse the data in the database to get useful information. The maximum number of the trends is 8.

How to Use the Historical Trends

In the previous figure, users can retrieve data shown in graphic from the database. The combination of all drop-down boxes is the criteria for retrieving data.

Note : The star sign (*) in drop-down boxes means all.

Note : If the number of retrieving data is more than 3000. You have to reset the selection criteria.

<div style="border: 1px solid gray; padding: 5px;"> <p>Type / Paint</p> <p><input checked="" type="radio"/> Line </p> <p><input type="radio"/> Column </p> </div>	<input checked="" type="radio"/> Line	Switch a bar chart to line chart.
	<input type="radio"/> Column	Switch a line chart to a bar chart.
		Retrieve data from the database and then draw a line chart or bar chart.

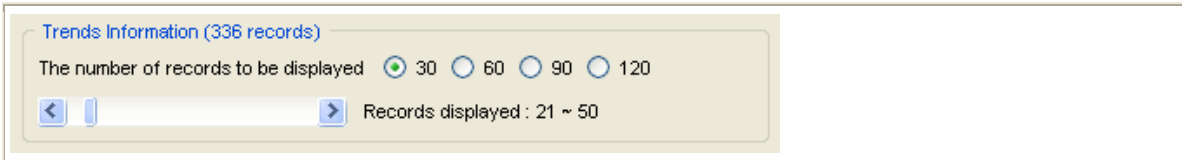

1. It tells users the total number of data displayed.
2. Users can decide the number of records to be displayed. There are 4 options: 30, 60, 90, 120.
3. It tells users the range of serial number of the data displayed.

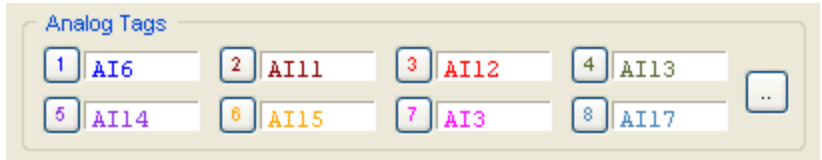

When any of the button ~ is pressed, you can see the following figure. It shows users the detailed information of the corresponding tag.

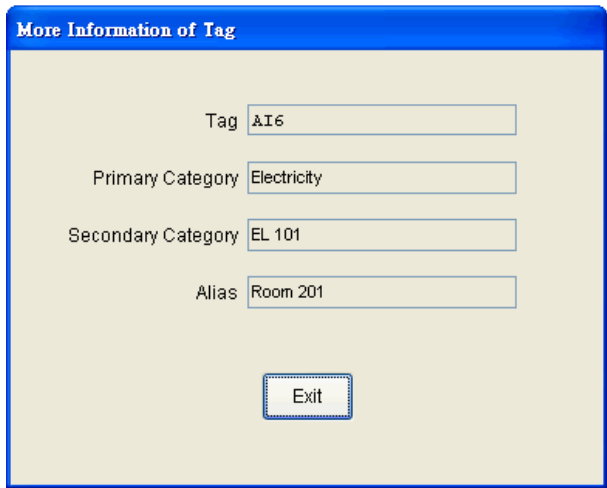

When the button is pressed, you can see the following figure. Users can set Tag1 ~ Tag8.

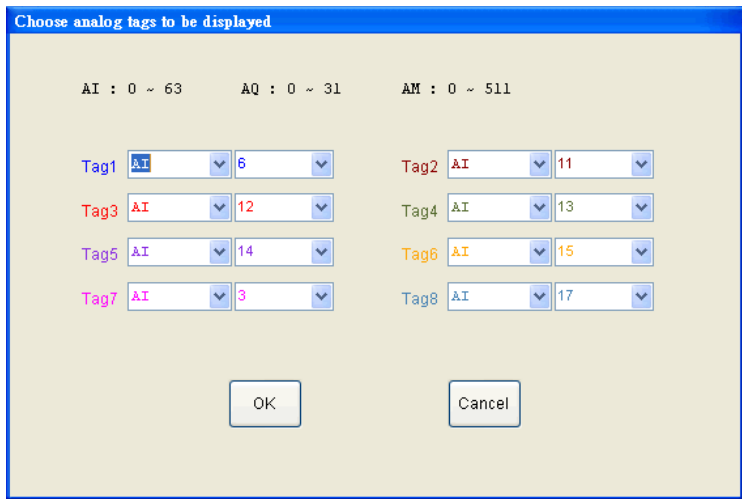

4.6 Realtime Trends

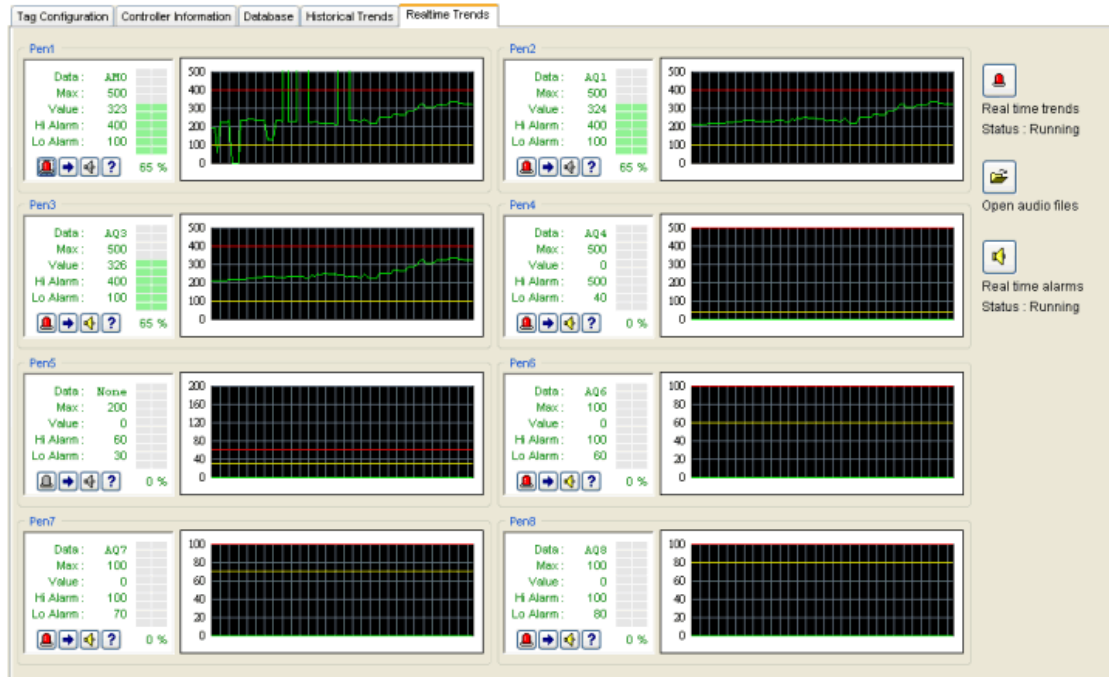

When the tab on the upper tabs is switched to **Realtime Trends**, you can see the figure below.



We provide users with realtime trends. Users can receive realtime information. The maximum number of the trends is 8.

How to Use the Realtime Trends

The below instructions show you more information.

	The main switch to start or stop the operation of realtime trends.
	Open an audio file for alarm.
	The main switch to start or stop the operation of alarm.

More Information about Individual Trend

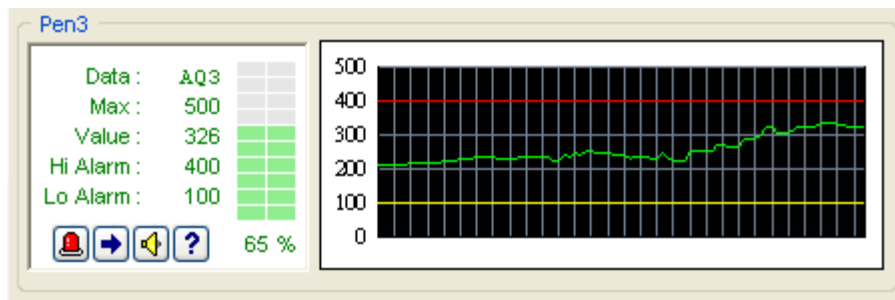

	The switch to start or stop the operation of individual realtime trends.
	Settings for individual pen.
	The main switch to start or stop the operation of individual alarm.
	Show users the detailed information of the corresponding data.

When the button is pressed, you can see the following figure. Users can set the individual pen.

Settings of Pen3

Tag:

Max:

High Alarm:

Low Alarm: