



EasyBuilder Pro

Ver. 5.07.01

- 1. EasyBuilder Pro Installation and Startup Guide 1-1
 - 1.1. Installation Requirements..... 1-2
 - 1.2. Steps to Install EasyBuilder Pro 1-3
- 2. Utility Manager 2-1
 - 2.1. Overview..... 2-2
 - 2.2. HMI IP, Password 2-4
 - 2.3. Editing Tools..... 2-5
 - 2.3.1. Build Download Data for SD/USB Disk 2-5
 - 2.3.2. Steps to Download Project to HMI via USB Disk or SD Card 2-5
 - 2.4. Transfer 2-6
 - 2.4.1. Download..... 2-6
 - 2.4.2. Upload 2-7
 - 2.5. Simulation..... 2-8
 - 2.5.1. Off-line Simulation / On-line Simulation 2-8
 - 2.6. Pass-Through 2-9
- 3. Create an EasyBuilder Pro Project 3-1
 - 3.1. Overview..... 3-2
 - 3.2. Create a New Project File 3-2
 - 3.3. Save and Compile the Project File 3-4
 - 3.4. Run On-Line or Off-Line Simulation..... 3-5
 - 3.5. cMT Viewer..... 3-5
 - 3.6. Download the Project File to HMI 3-6
 - 3.6.1. Configure in EasyBuilder Pro 3-6
 - 3.6.2. Use HMI Name..... 3-9
 - 3.6.3. Use USB cable 3-10
 - 3.6.4. Use USB Drive or SD Card 3-11
 - 3.7. Upload the Project File from HMI..... 3-12
- 4. Hardware Settings..... 4-1
 - 4.1. Overview..... 4-2
 - 4.2. I/O Ports..... 4-2
 - 4.3. LED Indicators 4-2
 - 4.4. System Reset..... 4-3
 - 4.5. System Toolbar..... 4-4
 - 4.5.1. System Setting 4-4
 - 4.5.2. System Information 4-8
 - 4.6. EasySystemSetting 4-8
- 5. System Parameter Settings 5-1
 - 5.1. Overview..... 5-2

- 5.2. Device 5-2
 - 5.2.1. How to Control a Local PLC.....5-2
 - 5.2.2. How to Control a Remote PLC5-7
 - 5.2.3. How to Control a Remote HMI5-9
- 5.3. Model..... 5-11
- 5.4. General 5-14
- 5.5. System Setting 5-17
- 5.6. Security 5-19
 - 5.6.1. General Mode.....5-20
 - 5.6.2. Enhanced Security Mode.....5-20
- 5.7. Font..... 5-22
 - 5.7.1. eMT, iE, XE, mTV Series.....5-22
 - 5.7.2. cMT Series5-23
- 5.8. Extended Memory 5-24
- 5.9. Printer / Backup Server..... 5-26
- 5.10. Time Sync./DST 5-27
- 5.11. e-Mail..... 5-28
- 5.12. Recipes..... 5-31
- 5.13. Cellular Data Network 5-32
- 6. Window Operations 6-1
 - 6.1. Overview..... 6-2
 - 6.2. Window Types 6-2
 - 6.2.1. Base Window6-2
 - 6.2.2. Fast Selection Window6-2
 - 6.2.3. Common Window.....6-3
 - 6.2.4. System Message Window6-3
 - 6.3. Create, Set, and Delete a Window..... 6-4
 - 6.3.1. Creating and Setting a Window6-5
 - 6.3.2. Open, Close, and Delete a Window.....6-7
 - 6.4. Window Transparency 6-7
- 7. Event Log..... 7-1
 - 7.1. Overview..... 7-2
 - 7.2. Event Log Management 7-2
 - 7.2.1. eMT, iE, XE, mTV Series.....7-2
 - 7.2.2. cMT Series7-4
 - 7.2.3. Excel Editing7-7
 - 7.2.4. Quick View of Errors7-7
 - 7.3. Creating a New Event Log..... 7-8

- 8. Data Sampling 8-1
 - 8.1. Overview 8-2
 - 8.2. Data Sampling Management 8-2
 - 8.3. Creating a New Data Sampling 8-2
 - 8.3.1. Demonstration of Auto. stop 8-9
 - 8.3.2. Customized File Handling 8-9
 - 8.4. Synchronizing cMT Viewer data and Saving to External Device or Database 8-11
 - 8.5. Checking History Data of a Specific Date / File on cMT Viewer 8-12
- 9. Object General Properties 9-1
 - 9.1. Overview 9-2
 - 9.2. Selecting PLC and Setting Read/Write Address 9-2
 - 9.3. Using Shape Library and Picture Library 9-3
 - 9.3.1. Picture 9-4
 - 9.3.2. Shape 9-4
 - 9.3.3. Shape manager 9-6
 - 9.4. Setting Label Text 9-7
 - 9.5. Adjusting Profile Size 9-9
- 10. User Password and Object Security 10-1
 - 10.1. Overview 10-2
 - 10.2. User Password and Operable Object Classes 10-2
 - 10.2.1. General Mode 10-2
 - 10.2.2. Enhanced Security Mode 10-3
 - 10.3. Enhanced Security Mode and Control Address 10-3
 - 10.3.1. Control Address Settings 10-4
 - 10.3.2. Commands 10-4
 - 10.3.3. Command Execution Results 10-7
 - 10.4. Enhanced Security Mode Usage 10-7
 - 10.4.1. Importing User Accounts 10-7
 - 10.4.2. Login with USB Security Key 10-9
 - 10.4.3. Login / Logout Automatically with USB Security Key 10-10
 - 10.4.4. Enhanced Security Mode with Option List Object 10-11
 - 10.5. Object Security Settings 10-12
 - 10.6. Example of Object Security Settings 10-13
 - 10.7. Protecting Password Settings from Unauthorized Editing 10-16
- 11. Index Register 11-1
 - 11.1. Overview 11-2
 - 11.2. Examples of Index Register 11-2
- 12. Keyboard Design and Usage 12-1

12.1.	Overview	12-2
12.2.	Steps to Design a Popup Keyboard	12-2
12.3.	Steps to Design a Keyboard with Direct Window	12-5
12.4.	Steps to Design a Fixed Keyboard on Screen	12-6
12.5.	Steps to Design a UNICODE Keyboard	12-7
13.	Objects	13-1
13.1.	Bit Lamp	13-3
13.1.1.	Overview	13-3
13.1.2.	Configuration	13-3
13.2.	Word Lamp	13-5
13.2.1.	Overview	13-5
13.2.2.	Configuration	13-5
13.3.	Set Bit.....	13-10
13.3.1.	Overview.....	13-10
13.3.2.	Configuration	13-10
13.4.	Set Word	13-12
13.4.1.	Overview.....	13-12
13.4.2.	Configuration	13-12
13.5.	Function Key	13-20
13.5.1.	Overview.....	13-20
13.5.2.	Configuration	13-20
13.6.	Toggle Switch	13-25
13.6.1.	Overview.....	13-25
13.6.2.	Configuration	13-25
13.7.	Multi-State Switch	13-27
13.7.1.	Overview.....	13-27
13.7.2.	Configuration	13-27
13.8.	Slider.....	13-31
13.8.1.	Overview.....	13-31
13.8.2.	Configuration	13-31
13.8.3.	Combo Setting	13-34
13.9.	Numeric	13-38
13.9.1.	Overview.....	13-38
13.9.2.	Configuration	13-38
13.10.	ASCII.....	13-53
13.10.1.	Overview.....	13-53
13.10.2.	Configuration	13-53
13.11.	Indirect Window	13-56

13.11.1. Overview	13-56
13.11.2. Configuration	13-56
13.12. Direct Window	13-60
13.12.1. Overview	13-60
13.12.2. Configuration	13-60
13.13. Moving Shape	13-64
13.13.1. Overview	13-64
13.13.2. Configuration	13-64
13.14. Animation	13-68
13.14.1. Overview	13-68
13.14.2. Configuration	13-68
13.15. Bar Graph	13-72
13.15.1. Overview	13-72
13.15.2. Configuration	13-72
13.15.3. Combo Setting	13-76
13.16. Meter Display	13-80
13.16.1. Overview	13-80
13.16.2. Configuration	13-80
13.17. Trend Display	13-88
13.17.1. Overview	13-88
13.17.2. Configuration	13-88
13.18. History Data Display	13-101
13.18.1. Overview	13-101
13.18.2. Configuration	13-101
13.19. Data Block Display	13-107
13.19.1. Overview	13-107
13.19.2. Configuration	13-107
13.20. XY Plot	13-115
13.20.1. Overview	13-115
13.20.2. Configuration	13-115
13.21. Alarm Bar and Alarm Display	13-121
13.21.1. Overview	13-121
13.21.2. Configuration	13-121
13.22. Event Display	13-127
13.22.1. Overview	13-127
13.22.2. Configuration	13-127
13.23. Data Transfer (Trigger-based)	13-136
13.23.1. Overview	13-136

13.23.2. Configuration	13-136
13.24. Backup	13-138
13.24.1. Overview	13-138
13.24.2. Configuration	13-138
13.25. Media Player	13-145
13.25.1. Overview	13-145
13.25.2. Configuration	13-145
13.26. Data Transfer	13-151
13.26.1. Overview	13-151
13.26.2. Configuration	13-151
13.27. PLC Control	13-155
13.27.1. Overview	13-155
13.27.2. Configuration	13-155
13.28. Scheduler	13-162
13.28.1. Overview	13-162
13.28.2. Configuration	13-162
13.29. Option List.....	13-171
13.29.1. Overview	13-171
13.29.2. Configuration	13-171
13.30. Timer.....	13-179
13.30.1. Overview	13-179
13.30.2. Configuration	13-179
13.31. Video In.....	13-183
13.31.1. Overview	13-183
13.31.2. Configuration	13-183
13.32. System Message	13-189
13.32.1. Overview	13-189
13.32.2. Configuration	13-189
13.33. Recipe View	13-191
13.33.1. Overview	13-191
13.33.2. Configuration	13-191
13.34. Flow Block.....	13-197
13.34.1. Overview	13-197
13.34.2. Configuration	13-197
13.35. Operation Log	13-201
13.35.1. Operation Log Settings	13-201
13.35.2. Operation Log View	13-204
13.35.3. Operation Log Printing.....	13-207

13.36. Combo Button.....	13-213
13.36.1. Overview.....	13-213
13.36.2. Configuration	13-213
13.37. Circular Trend Display	13-216
13.37.1. Overview.....	13-216
13.37.2. Configuration	13-216
13.38. Picture View.....	13-225
13.38.1. Overview.....	13-225
13.38.2. Configuration	13-225
13.39. File Browser	13-228
13.39.1. Overview.....	13-228
13.39.2. Configuration	13-228
13.40. Import/Export.....	13-231
13.40.1. Overview.....	13-231
13.40.2. Configuration	13-231
13.41. Pie Chart	13-235
13.41.1. Overview.....	13-235
13.41.2. Configuration	13-235
13.41.3. Combo Setting	13-237
13.42. 2D Barcode Display.....	13-240
13.42.1. Overview.....	13-240
13.42.2. Configuration	13-240
13.43. String Table	13-242
13.43.1. Overview.....	13-242
13.43.2. Configuration	13-242
13.44. Database Server.....	13-244
13.44.1. Overview.....	13-244
13.44.2. Configuration	13-244
13.45. Dynamic Scale.....	13-248
13.45.1. Overview.....	13-248
13.45.2. Configuration	13-248
13.46. Dynamic Drawing.....	13-251
13.46.1. Overview.....	13-251
13.46.2. Configuration	13-251
13.47. PDF Reader	13-256
13.47.1. Overview.....	13-256
13.47.2. Configuration	13-256
13.48. Table.....	13-258

- 13.48.1. Overview 13-258
- 13.48.2. Configuration 13-258
- 13.49. VNC Viewer 13-260
 - 13.49.1. Overview 13-260
 - 13.49.2. Configuration 13-260
- 13.50. Barcode Scanner (Android Camera) 13-264
 - 13.50.1. Overview 13-264
 - 13.50.2. Configuration 13-264
- 13.51. Contacts Editor 13-270
 - 13.51.1. Overview 13-270
 - 13.51.2. Configuration 13-270
- 14. Shape Library and Picture Library 14-1
 - 14.1. Overview 14-2
 - 14.2. Building Shape Library 14-2
 - 14.2.1. Shape manager 14-2
 - 14.2.2. Steps to Build Shape Library 14-4
 - 14.3. Building Picture Library 14-9
 - 14.3.1. Picture manager 14-9
 - 14.3.2. Steps to Build Picture Library 14-11
 - 14.3.3. Steps to Import Picture by Pasting 14-13
 - 14.4. Immediate Modification and Preview 14-14
 - 14.4.1. Replacing a Picture 14-15
 - 14.4.2. Replacing a Color 14-15
 - 14.4.3. Extended Features 14-16
 - 14.4.4. Docking a Window 14-17
- 15. Label Tag Library and Multi-Language 15-1
 - 15.1. Overview 15-2
 - 15.2. Label Tag Library Manager 15-2
 - 15.3. Steps to create Label Tag Library 15-3
 - 15.4. Using Label Tag Library 15-4
 - 15.5. Settings of Multi-Language 15-5
- 16. Address Tag Library 16-1
 - 16.1. Overview 16-2
 - 16.2. Building Address Tag Library 16-2
 - 16.3. Using Address Tag Library 16-4
- 17. Transferring Recipe Data 17-1
 - 17.1. Overview 17-2
 - 17.2. Steps to Update Recipe Data with Ethernet or USB Cable 17-2

- 17.3. Steps to Update Recipe Data with SD Card or USB Disk..... 17-3
- 17.4. Transferring Recipe Data..... 17-3
- 17.5. Saving Recipe Data Automatically 17-4
- 18. Macro Reference.....18-1
 - 18.1. Overview..... 18-2
 - 18.2. Instructions to use the Macro Editor 18-2
 - 18.3. Configuration 18-7
 - 18.4. Syntax..... 18-8
 - 18.4.1. Constants and Variables18-8
 - 18.4.2. Operators18-10
 - 18.5. Statement 18-14
 - 18.5.1. Definition Statement18-14
 - 18.5.2. Assignment Statement18-14
 - 18.5.3. Logical Statements.....18-14
 - 18.5.4. Selective Statements18-16
 - 18.5.5. Iterative Statements18-17
 - 18.6. Function Blocks..... 18-19
 - 18.7. Built-In Function Block..... 18-22
 - 18.7.1. Mathematical Functions18-22
 - 18.7.2. Data Transformation18-28
 - 18.7.3. Data Manipulation18-32
 - 18.7.4. Bit Transformation18-34
 - 18.7.5. Communication18-36
 - 18.7.6. String Operation Functions.....18-50
 - 18.7.7. Recipe Query Function18-77
 - 18.7.8. Miscellaneous.....18-79
 - 18.8. How to Create and Execute a Macro 18-85
 - 18.8.1. How to Create a Macro.....18-85
 - 18.8.2. Execute a Macro18-89
 - 18.9. User Defined Macro Function..... 18-89
 - 18.9.1. Import Function Library File18-90
 - 18.9.2. How to Use Macro Function Library.....18-91
 - 18.9.3. Function Library Management Interface.....18-93
 - 18.10. Some Notes about Using the Macro 18-102
 - 18.11. Use the Free Protocol to Control a Device 18-102
 - 18.12. Compiler Error Message 18-107
 - 18.13. Sample Macro Code..... 18-113
 - 18.14. Macro TRACE Function 18-118

18.15. Example of String Operation Functions	18-122
18.16. Macro Password Protection.....	18-130
19. Configure HMI as a MODBUS Server	19-1
19.1. Overview.....	19-2
19.2. Steps to Create a MODBUS Server	19-2
19.3. Steps to Access a MODBUS Server	19-4
19.4. Changing MODBUS Server Station Number Online.....	19-6
19.5. MODBUS Address Type.....	19-6
20. How to Connect a Barcode Reader	20-1
20.1. Overview.....	20-2
20.2. Steps to Connect a Barcode Reader	20-2
21. Ethernet Communication and Multi-HMI Connection	21-1
21.1. Overview.....	21-2
21.2. HMI to HMI Communication	21-2
21.3. PC to HMI Communication	21-3
21.4. Operating the PLC Connected with Other HMI	21-4
21.4.1. Settings of eMT / mTV Series	21-5
21.4.2. Settings of cMT-SVR Series	21-6
22. System Registers	22-1
22.1. Overview.....	22-3
22.2. The Address Ranges of Local HMI	22-4
22.2.1. Bits	22-4
22.2.2. Words.....	22-4
22.3. System Registers	22-5
22.3.1. HMI Time	22-5
22.3.2. HMI Operation	22-6
22.3.3. Touch Position.....	22-7
22.3.4. Local HMI Network Information	22-7
22.3.5. Project File Information	22-9
22.3.6. Storage Space Management.....	22-10
22.3.7. Recipe and Extended Memory	22-10
22.3.8. Data Sampling.....	22-11
22.3.9. Event Log.....	22-12
22.3.10. Station Number Variables.....	22-13
22.3.11. Index Registers.....	22-14
22.3.12. MODBUS Server Communication	22-15
22.3.13. Communication Parameter Settings.....	22-16
22.3.14. Communication Status and Control with PLC (COM)	22-19

22.3.15. Communication Status and Control with PLC (Ethernet)	22-20
22.3.16. Communication Status and Control with PLC (USB)	22-22
22.3.17. Communication Status and Control with PLC (CAN Bus).....	22-23
22.3.18. Communication Status and Control with Remote HMI	22-23
22.3.19. Communication Status and Control with Remote PLC	22-27
22.3.20. Local/Remote Operation Restrictions	22-29
22.3.21. Communication Error Codes.....	22-29
22.3.22. Driver ID	22-31
22.3.23. DLT645 Controller	22-31
22.3.24. [PLC No Response] Window Control	22-31
22.3.25. [Fast Selection] Window Control	22-32
22.3.26. EasyAccess	22-32
22.3.27. EasyAccess 2.0	22-32
22.3.28. Remote Print/Backup Server	22-33
22.3.29. Pass-Through Settings.....	22-33
22.3.30. VNC Control	22-34
22.3.31. Project Key and HMI Key	22-35
22.3.32. USB Security Key	22-35
22.3.33. User Name and Password.....	22-36
22.3.34. Macro.....	22-37
22.3.35. Input Object Function.....	22-38
22.3.36. Time Sync./Daylight Saving Time.....	22-38
22.3.37. Cellular Data Network	22-40
22.3.38. Wi-Fi Setting	22-40
22.3.39. OPC UA Server	22-42
22.3.40. e-Mail.....	22-42
22.3.41. Miscellaneous.....	22-44
23. HMI Supported Printers	23-1
23.1. The Supported Printer Types	23-2
23.2. Steps to Add a New Printer and Start Printing	23-5
23.3. The Supported Printer Types on cMT3151.....	23-7
24. Recipe Editor.....	24-1
24.1. Overview.....	24-2
24.2. Recipe / Extended Memory Editor Setting	24-2
24.3. Recipe Records Setting	24-4
25. EasyConverter	25-1
25.1. Overview.....	25-2
25.2. Converting Data Log File to Excel File	25-2

- 25.3. Converting Event Log File to Excel File 25-4
- 25.4. Converting Operation Log File to Excel File 25-5
- 25.5. Converting Multiple Files..... 25-6
- 25.6. Scaling Function 25-8
- 25.7. Batch File 25-9
- 26. EasyPrinter 26-1
 - 26.1. Overview 26-2
 - 26.2. Using EasyPrinter as a Printer Server 26-3
 - 26.2.1. Setup Procedure in EasyPrinter 26-3
 - 26.2.2. Setup Procedure in EasyBuilder Pro 26-4
 - 26.3. Using EasyPrinter as a Backup Sever 26-6
 - 26.3.1. Setup Procedure in EasyPrinter 26-6
 - 26.3.2. Setup Procedure in EasyBuilder Pro 26-7
 - 26.4. EasyPrinter Operation Guide 26-10
 - 26.4.1. EasyPrinter Managing Window 26-10
 - 26.4.2. Operation Guide 26-11
 - 26.5. Convert Batch File..... 26-15
 - 26.5.1. The Default Value of Convert Batch File 26-15
 - 26.5.2. Specialized Criteria 26-16
 - 26.5.3. The Format of a Convert Batch File 26-17
 - 26.5.4. The Order of Examining Criterion..... 26-17
- 27. EasySimulator..... 27-1
 - 27.1. Overview..... 27-2
 - 27.2. Steps to setup EasySimulator 27-2
- 28. Multi-HMI Communication (Master Slave Mode) 28-1
 - 28.1. Overview..... 28-2
 - 28.2. Steps to Create a Project of Master HMI..... 28-2
 - 28.3. Steps to Create a Project of Slave HMI 28-3
 - 28.4. Steps to Connect with MT500 Slave HMI 28-5
 - 28.4.1. Settings in EasyBuilder Pro 28-5
 - 28.4.2. Settings in EasyBuilder500..... 28-6
- 29. Pass-through 29-1
 - 29.1. Overview..... 29-2
 - 29.2. Ethernet Mode 29-2
 - 29.2.1. Steps to Install Virtual Serial Port Driver 29-2
 - 29.2.2. Steps to Change the Virtual Serial Port Number 29-3
 - 29.2.3. Steps to Uninstall the Virtual Serial Port 29-3
 - 29.2.4. Steps to Update Virtual Serial Port Driver 29-4

29.2.5.	Settings of Ethernet mode	29-5
29.3.	COM Port Mode	29-7
29.3.1.	Settings of COM Port Mode	29-7
29.3.2.	Using Utility Manager	29-7
29.3.3.	Using System Registers	29-9
29.4.	Pass-through Control	29-9
29.5.	SIEMENS S7-200 PPI and S7-300 MPI Pass-through Settings	29-10
29.5.1.	EasyBuilder Pro Settings	29-10
29.5.2.	S7-200 PPI Connection	29-10
29.5.3.	S7-300 MPI Connection	29-11
29.5.4.	Registers of SIEMENS Pass-through.....	29-13
30.	Project Protection	30-1
30.1.	Overview	30-2
30.2.	EXOB Password	30-2
30.3.	Decompilation is Prohibited	30-3
30.4.	Disable EXOB Upload Function	30-3
30.5.	Project Key	30-3
30.6.	EMTP Password	30-4
31.	Memory Map	31-1
31.1.	Overview	31-2
31.2.	PIN Settings.....	31-2
31.3.	Communication Flowchart	31-3
31.4.	Address Types	31-4
31.4.1.	Communication Examples	31-5
31.5.	Settings	31-7
31.5.1.	Steps to Add a Memory Map Device	31-7
31.5.2.	Object Settings.....	31-8
31.5.3.	Executing the Settings	31-9
32.	FTP Server Application	32-1
32.1.	Overview	32-2
32.2.	Steps to Log in FTP Server	32-2
32.3.	Backup History Data and Update Recipe Data	32-3
33.	EasyDiagnoser	33-1
33.1.	Overview	33-2
33.2.	Configuration	33-2
33.3.	EasyDiagnoser Settings.....	33-3
33.3.1.	Main Menu	33-3
33.3.2.	Activity Area.....	33-4

- 33.3.3. Polling Packages33-6
- 33.3.4. Devices.....33-8
- 33.3.5. Output (Macro debug).....33-8
- 33.4. Error Code..... 33-9
- 33.5. Window Adjustment..... 33-10
- 34. Rockwell EtherNet/IP Free Tag Names34-1
 - 34.1. Overview..... 34-2
 - 34.2. Steps to Import User-Defined AB Tag CSV File to EasyBuilder Pro 34-2
 - 34.3. Steps to Add a New Data Type..... 34-4
 - 34.4. Steps to Paste 34-6
 - 34.5. Miscellaneous Functions 34-7
 - 34.6. Module-Defined..... 34-8
- 35. EasyWatch.....35-1
 - 35.1. Overview..... 35-2
 - 35.2. Configuration 35-2
 - 35.2.1. Basic Functions35-2
 - 35.2.2. Quick Selection Tools35-3
 - 35.3. Monitor Settings 35-4
 - 35.3.1. Adding a Monitor.....35-4
 - 35.3.2. Monitor Settings.....35-4
 - 35.3.3. Steps to Add a New Monitor35-5
 - 35.4. Macro Settings 35-8
 - 35.4.1. Adding a Macro.....35-8
 - 35.4.2. Macro Settings.....35-8
 - 35.4.3. Steps to Add a New Macro35-8
 - 35.5. HMI Manager..... 35-9
 - 35.5.1. Opening HMI Setting 35-9
 - 35.5.2. HMI Manager.....35-10
 - 35.6. Object List..... 35-11
 - 35.6.1. Object List Columns35-11
 - 35.6.2. Editing Object List.....35-12
- 36. Administrator Tools.....36-1
 - 36.1. Overview..... 36-2
 - 36.2. User Accounts..... 36-2
 - 36.2.1. User Accounts Settings36-2
 - 36.2.2. Steps to Set User Accounts.....36-4
 - 36.2.3. Steps to Import Accounts Using EasyBuilder Pro36-5
 - 36.3. USB Security Key..... 36-6

36.3.1.	USB Security Key Settings	36-6
36.3.2.	Steps to Set USB Security Key	36-7
36.3.3.	Steps to Set USB Security Key Using EasyBuilder Pro	36-8
36.4.	e-Mail SMTP Server Settings	36-9
36.4.1.	Steps to set e-Mail SMTP Server Settings.....	36-9
36.5.	e-Mail Contacts.....	36-10
36.5.1.	e-Mail Contacts Settings	36-10
36.5.2.	Steps to set e-Mail Contacts	36-11
36.5.3.	Steps to Import e-Mail Settings and Contacts Using EasyBuilder Pro	36-13
37.	MODBUS TCP/IP Gateway.....	37-1
37.1.	Overview.....	37-2
37.2.	Steps to Create an Address Mapping Table.....	37-2
37.3.	Notes about Configuring Address Mapping	37-5
38.	EasyDownload.....	38-1
38.1.	Overview.....	38-2
38.2.	Configuration	38-2
39.	Data Security.....	39-1
39.1.	Overview.....	39-2
39.2.	Configuration	39-2
39.2.1.	Word address settings	39-3
39.2.2.	Bit address settings.....	39-5
40.	Web Streaming	40-1
40.1.	Overview.....	40-2
40.2.	Configuration	40-2
40.3.	Operation.....	40-2
40.4.	Applicable Models	40-3
41.	Energy	41-1
41.1.	Energy Demand Setting	41-2
41.1.1.	Overview.....	41-2
41.1.2.	Configuration	41-2
41.2.	Energy Demand Display	41-6
41.2.1.	Overview.....	41-6
41.2.2.	Configuration	41-6
42.	IIoT	42-1
42.1.	MQTT	42-2
42.1.1.	Overview.....	42-2
42.1.2.	Configuration	42-2
42.2.	OPC UA Server	42-13

42.2.1. Overview	42-13
42.2.2. Configuration	42-13
Appendix A. Comparison of HMI Software Features.....	A-1

1. EasyBuilder Pro Installation and Startup Guide

This chapter explains how to install EasyBuilder Pro.

1.1. Installation Requirements.....	1-2
1.2. Steps to Install EasyBuilder Pro	1-3

1.1. Installation Requirements

Software:

Download EasyBuilder Pro from CD-ROM or visit Weintek Labs, Inc.'s website at <http://www.weintek.com>. The language versions include Simplified Chinese, Traditional Chinese, English, Japanese, German, Italian, Korean, Spanish, Russian, French, and Turkish. The latest upgraded files can be downloaded too.

Hardware (Recommended):

CPU: INTEL Pentium II or higher

Memory: 256MB or higher

Hard Disk: 2.5GB or higher (Disc space available at least 500MB)

CD-ROM: 4X or higher

Display: 1024 x 768 resolution or greater

Keyboard and Mouse

Ethernet: for project downloading/uploading

USB Port 2.0: for project downloading/uploading

RS-232 COM: for on-line simulation

Printer

Operating System:

*Windows XP / SP3

Windows Vista

Windows 7 (32bit / 64bit)

Windows 8 (32bit / 64bit)

Windows 8.1 (32bit / 64bit)

Windows 10 (32bit / 64bit)

*EasyBuilder Pro V5.06.01 and later versions will no longer provide updates addressing the issues that arise while running the software in Windows XP / SP3.

1.2. Steps to Install EasyBuilder Pro

1. Insert the CD-ROM into your CD-ROM drive. The computer will automatically install EasyBuilder Pro driver. Or, you can manually execute [Autorun.exe] file under the root directory. The installation screen is shown as the following figure.



2. Click [Install] and select the language for the installation process, and then click [Next].

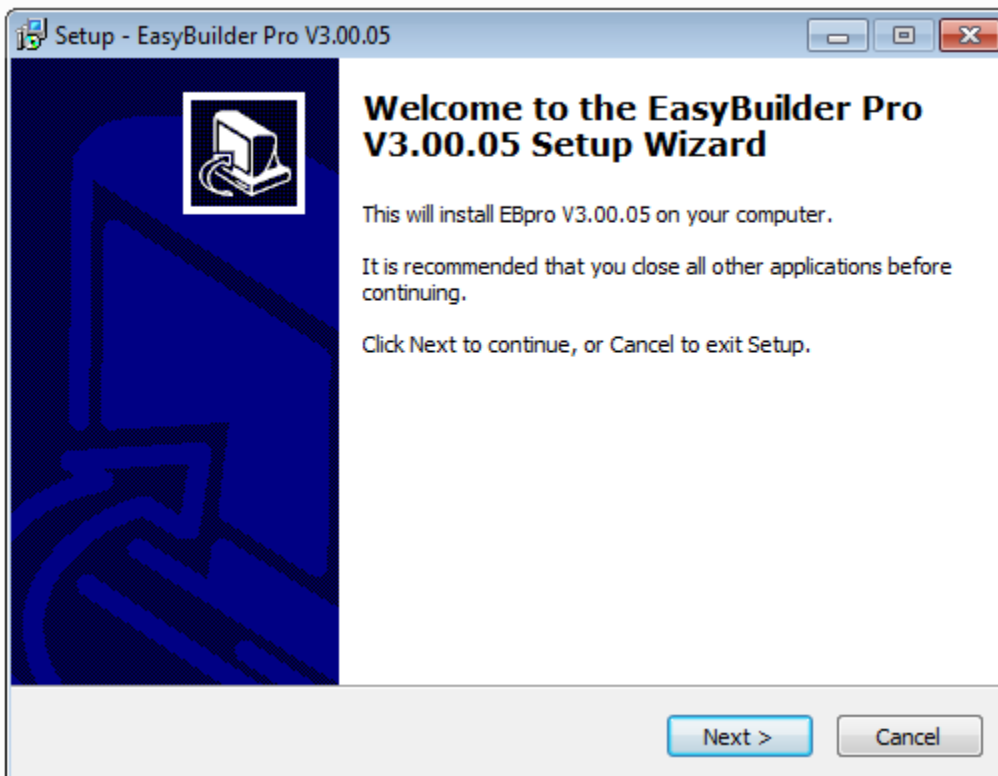

3. If there is a previous version of EasyBuilder Pro on the PC, please remove it before installation.
4. Select a folder for EasyBuilder Pro installation, or use the default folder. Click [Next].

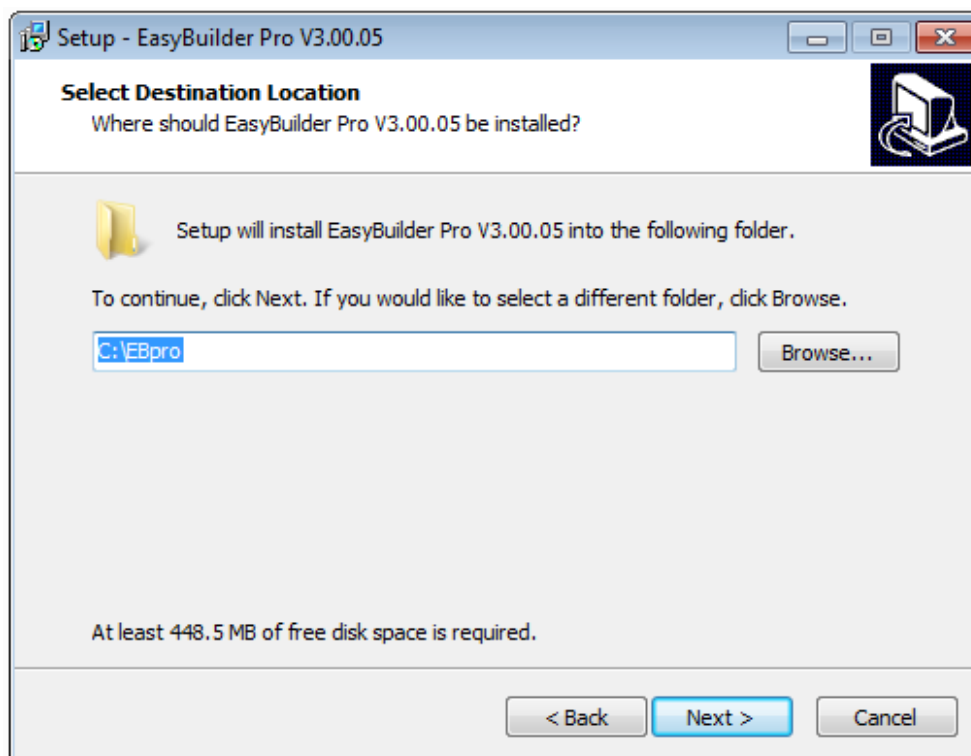

5. Select a start menu folder, or use the default folder. Click [Next].

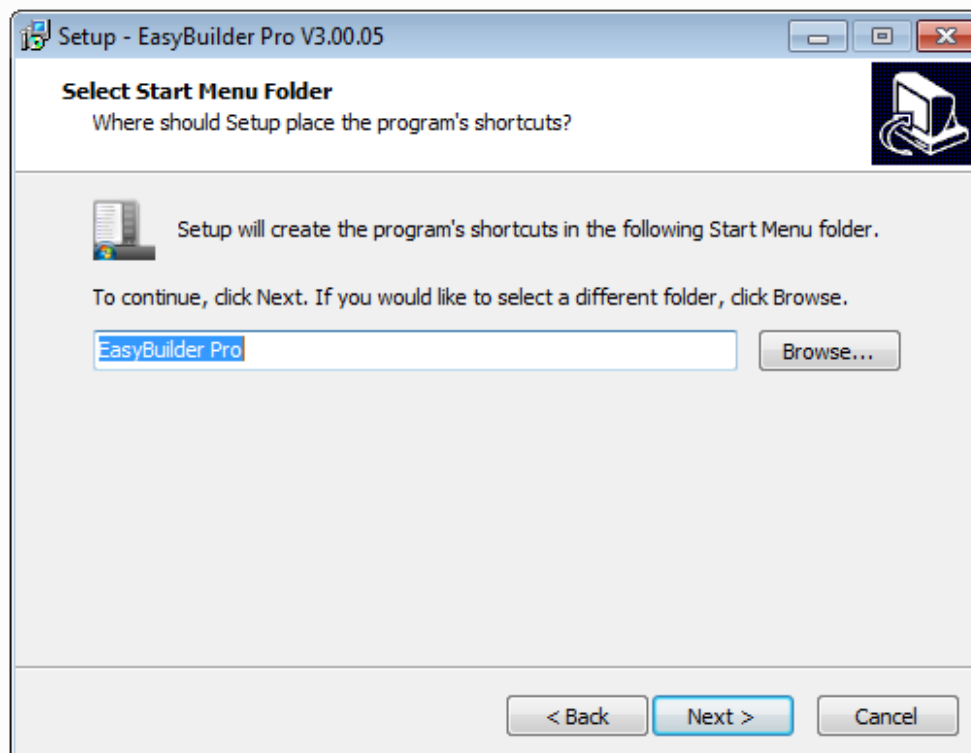

6. Select additional tasks, for example: [Create a desktop icon]. Click [Next].

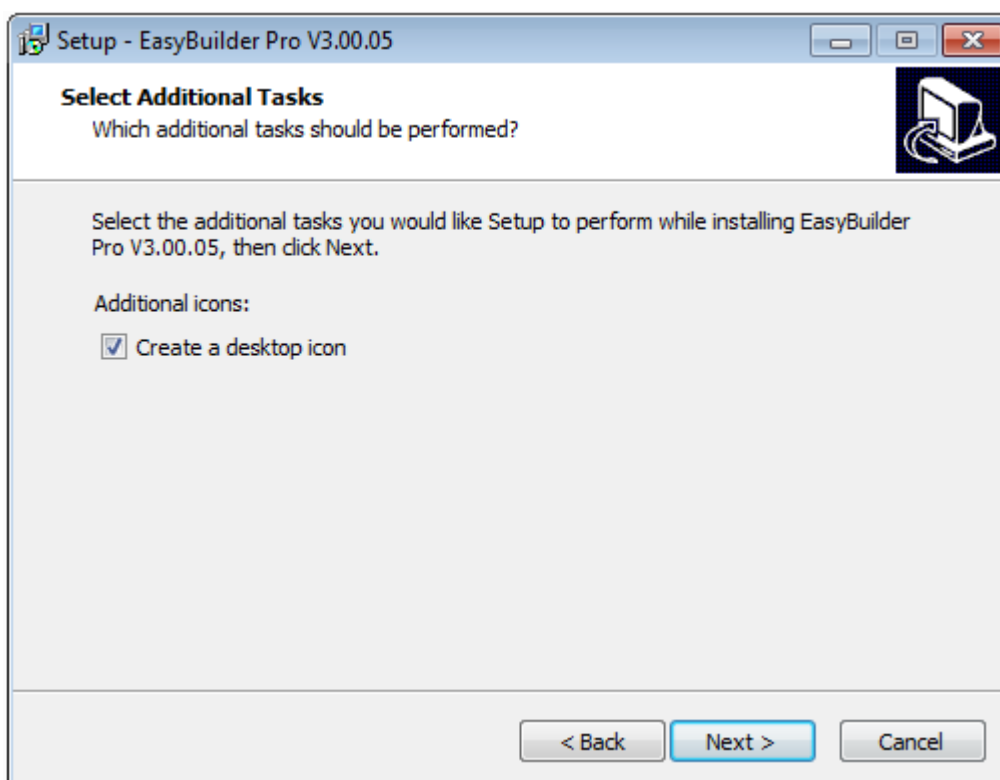

7. Confirm all settings. To change the setting, click [Back]. To start installation, click [Install].

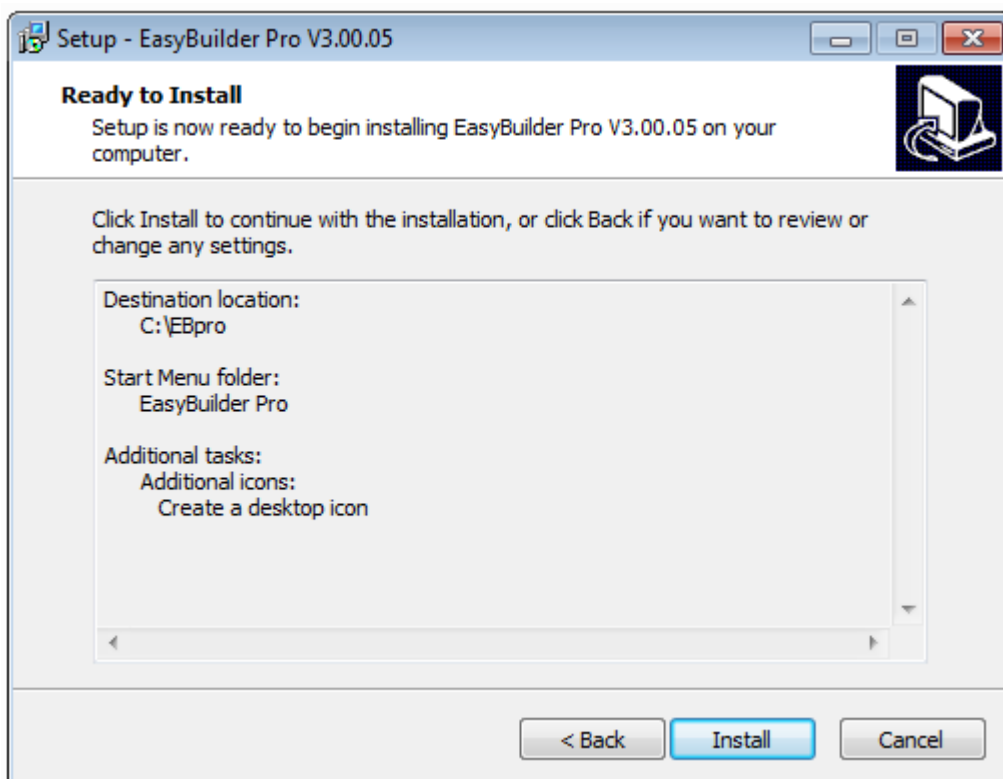

8. Installation progress.

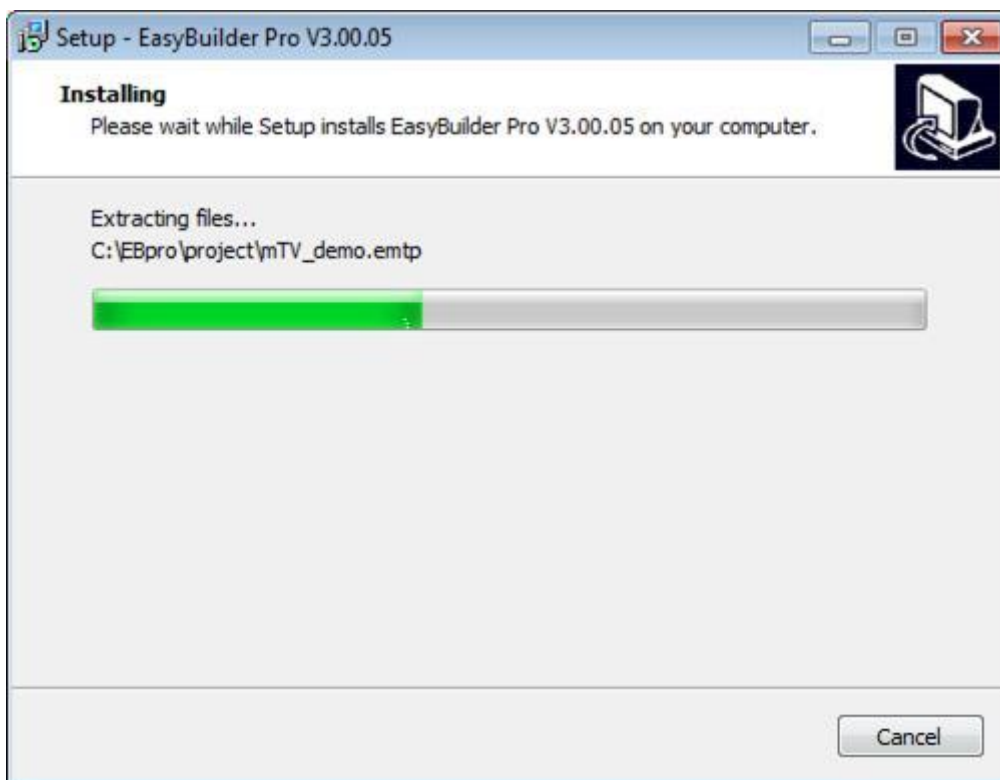

9. Click [Finish] to complete the installation.

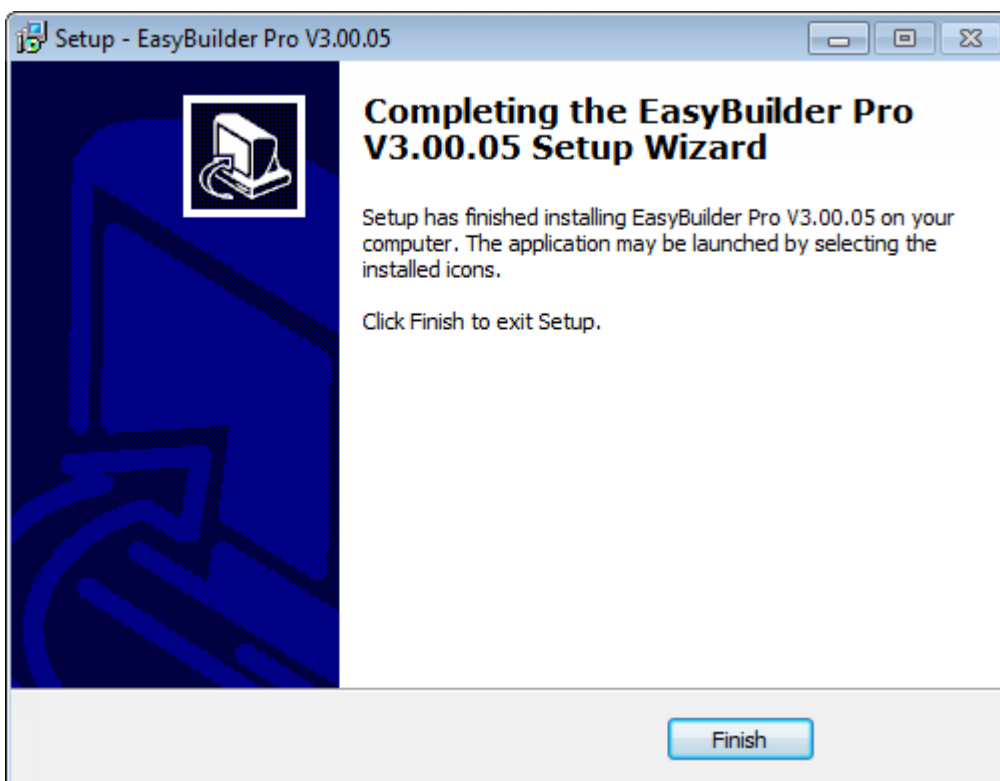

10. The EasyBuilder shortcut can be found in [Start] » [All Programs] » [EasyBuilder Pro].

The description of each item in EasyBuilder Pro menu:

Installed file	Description
Administrator Tools	Saves the data of User Accounts, USB Security Key, e-Mail SMTP Server Setting, e-Mail Contacts to USB disk and import to HMI.
cMT Viewer	Supports access to cMT Server (cMT-SVR) via network.
Easy Access	Supports access to any HMI connected to the internet. The HMI can be operated on PC.
EasyBuilder Pro	EasyBuilder Pro project editor.
EasyConverter	Conversion tool for Data Sampling and Event Log.
EasyDiagnoser	Monitoring and debugging tool operated on HMI.
EasyPrinter	Remote screen hardcopy and backup server.
EasySimulator	Executes simulation.
EasySystemSetting	Allows updating hardware system settings by using SD card or USB drive.
EasyWatch	On PC to monitor or set HMI and PLC address value.
Recipe Editor	Tool for setting the format of Recipe data. Users can open Recipe data or data in the External Memory.
Release Note	Software release notes.
Structure Editor	Supports AB TAG and improve the flexibility to read / write an object.
Utility Manager	EasyBuilder Pro management tool.

Note

- HMI supports downloading/uploading projects via USB cable. After installing EasyBuilder Pro, the USB driver will be automatically installed. A message saying “Windows can’t verify the publisher of this driver” may show, please continue anyway. After installing the USB driver, open [Computer Management] » [Device Manager] to check if installation succeeded.

2. Utility Manager



This chapter explains how to use Utility Manager.





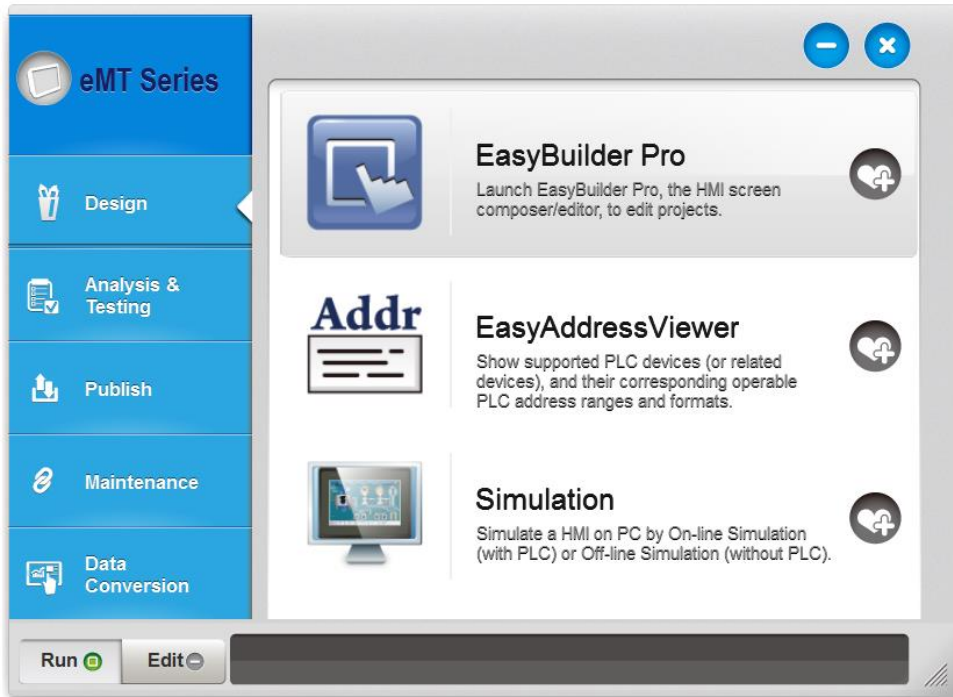



2.1.	Overview.....	2-2
2.2.	HMI IP, Password	2-4
2.3.	Editing Tools.....	2-5
2.4.	Transfer	2-6
2.5.	Simulation.....	2-8
2.6.	Pass-Through	2-9

2.1. Overview

After installing EasyBuilder Pro, double click [UtilityManagerEx] shortcut on the desktop to start. Utility Manager is for launching several utilities and it is a stand-alone program.



Utilities	Description
Select Model	Select your HMI model. Please note that if the model is incorrect, certain features may not work correctly.
Design	<p>EasyBuilder Pro: Launch EasyBuilder Pro to edit projects.</p> <p>EasyAddressViewer: Review the address ranges and formats of supported PLCs.</p> <p>Simulation: Simulate a HMI on PC by On-line Simulation (with PLC) or Off-line Simulation (without PLC).</p>
Analysis & Testing	<p>EasyDiagnoser: On-line monitoring and debugging tool. Diagnose the connection status between PC/HMI and PLC.  See "33 EasyDiagnoser".</p> <p>EasyWatch: Allows users to monitor HMI or PLC address values via Ethernet on PC.  See "35 EasyWatch".</p> <p>Reboot HMI: Restart a HMI to its initial condition by Ethernet or USB connection.</p> <p>Pass-Through: Allows PC applications to control PLC via HMI. In this case the HMI is an adaptor.</p>

	 See "29 Pass-through".
Publish	<p>Download: Download project file to HMI via Ethernet.</p> <p>Upload: Upload files on HMI to PC via Ethernet.</p> <p>Build Download Data for SD/USB Disk: Build the data to be saved in SD card / USB drive and then insert the device to HMI to download the data. This feature is not supported by cMT Series.</p>
Maintenance	<p>EasyPrinter, Backup/Printer Server: A backup/printer server on PC, which receives backups from HMI and run a defined batch to convert, or HMI screenshots to print out on PC.</p> <p>Administrator Tools: Allows storing the data of [User Accounts], [USB Security Key], [e-Mail SMTP Server Settings], and [e-Mail Contacts] to USB. This feature is not supported by cMT Series.</p> <p> See "36 Administrator Tools".</p> <p>cMT Viewer: Connect to a cMT-SVR machine. PC acts as a display terminal for cMT-SVR.</p> <p>Data/Event log Information: Connect with HMI via USB cable or Ethernet to check the number of history files in HMI. This feature is not supported by cMT Series.</p> <p>EasyAccess 1.0: Control remote HMI instantly and conveniently no matter which corners in the world you are. You can find more information at: www.ihmi.net</p>
Data Conversion	<p>Database Editor: Used to edit recipe data.</p> <p> Click the icon to download the document about Recipe Database.</p> <p>Easy Converter: Reads the data sampling file (.dtl) and event log file (.evt) in HMI and convert the files to Excel (.xls) format.</p> <p> See "25 EasyConverter".</p> <p>Recipe Editor: Used to create, view, and edit recipe data.</p> <p> See "24 Recipe Editor".</p>
	Minimize the window.
	Close the window.
	Add the frequently used utilities to the toolbar at the bottom of the window.
Run	Run the selected utility on the toolbar.
Edit	Delete the selected utility on the toolbar.

2.2. HMI IP, Password

Settings

When operating HMI via Ethernet or USB cable, please set the password for HMI to protect against unauthorized access.

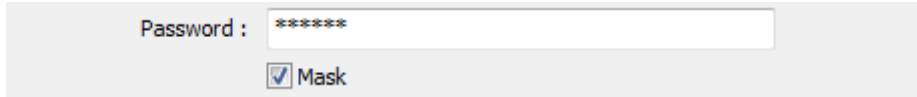

Set the download password. To use masking password, select [Mask] check box.

Note

- Please remember the password, otherwise, while restoring HMI default settings, the project files and data in HMI will be completely erased.

Reboot HMI

Reboot the HMI without unplugging. After reboot, the system returns to the initial state. Set the correct IP address when rebooting HMI via Ethernet.

Data/Event Log File Information

After setting, connect with HMI to check the number of history files in HMI.

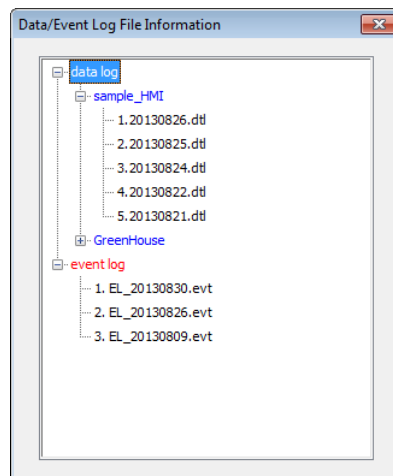

2.3. Editing Tools

2.3.1. Build Download Data for SD/USB Disk

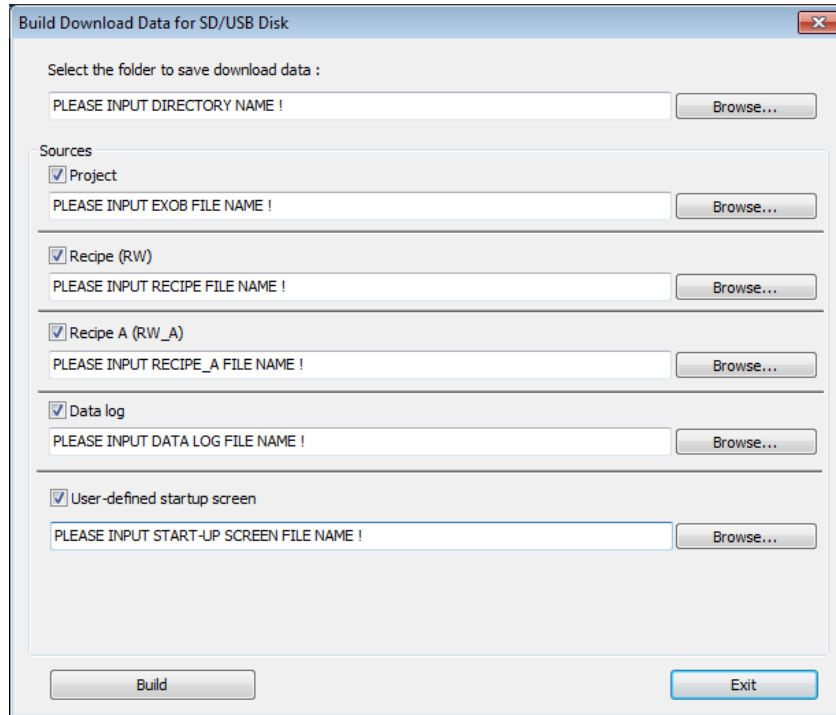

1. Insert an external device (SD card or USB drive) to PC.
2. Assign the directory to store data.
3. Select the directory of the source file.
4. Click [Build] to create files for downloading.

Files will then be store to the inserted device for users to download to HMI without connecting via a USB cable or Ethernet.

2.3.2. Steps to Download Project to HMI via USB Disk or SD Card

Assume we will download data in the folder named “123” (K:\123) on an USB disk.

1. Insert USB (in which the project is saved) to HMI.
2. In [Download / Upload] dialog box select [Download].
3. Enter Download Password.
4. In [Download Settings] dialog box, select [Download project files] and [Download history files] check boxes.
5. Press [OK].
6. In [Pick a Directory] dialog box, select directory: usbdisk\disk_a_1\123.
7. Press [OK].

Project will then be updated.

 Note

- If only the history files are downloaded, it is necessary to reboot HMI to update files.

2.4. Transfer

2.4.1. Download

Download files to HMI via Ethernet or USB cable.

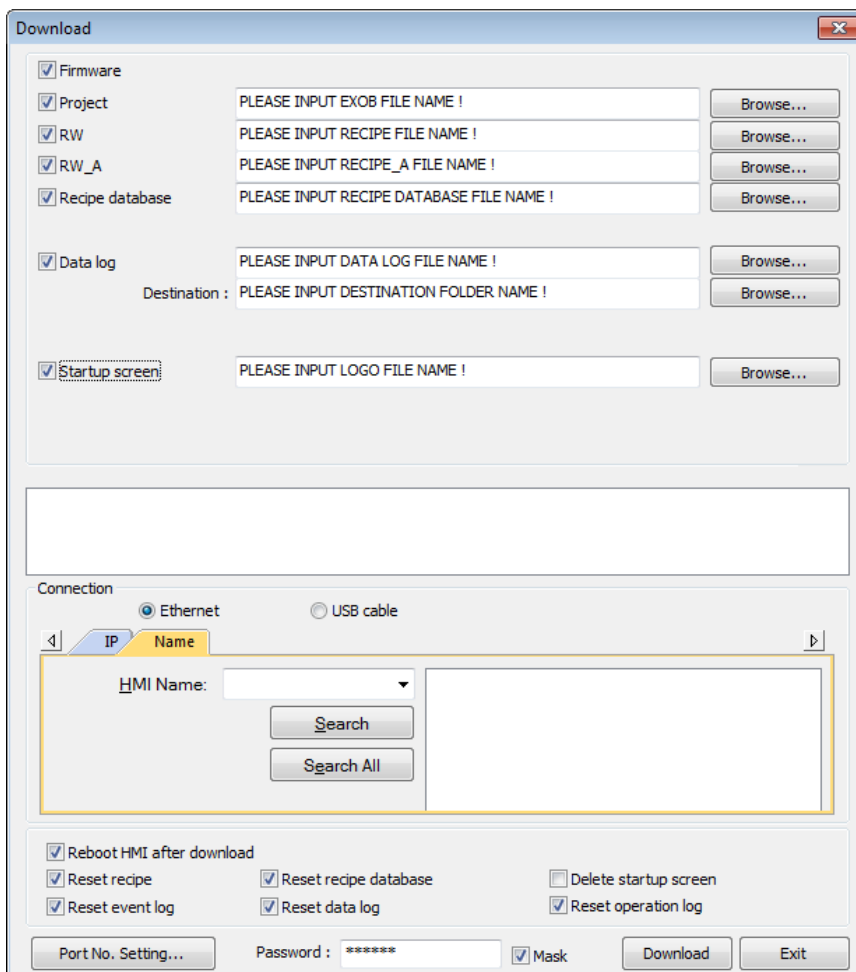

Setting	Description
Firmware	Update HMI kernel programs. The firmware must be downloaded at the first time downloading data to HMI.
Project	Select an .exob project file.
RW / RW_A	Select a .rcp recipe file.
Recipe database	Select a .db file of Recipe Database.
Data log	Select the data sampling folder in HMI and then

	select a .dtl file.
Startup screen	Download a .bmp bitmap file to HMI. After HMI is rebooted, this .bmp file will be shown before project starts.
Reboot HMI after download	Automatically reboot after download.
Port No. Setting	Select the port by which to download the project file via Ethernet.
Reset recipe / recipe database / event log / data log / operation log / Delete startup screen	Erase the selected files in HMI before download.

2.4.2. Upload

Upload files from HMI to PC via Ethernet or USB cable. Click [Browse] and assign the file path before uploading.

The 'Upload' dialog box is divided into several sections:

- File Selection:** A list of checkboxes on the left allows selecting files to upload: Project, RW, RW_A, Recipe database, Operation log, Data log, Event log, and Extend Memory (EM). To the right of each checkbox is a text input field with a 'PLEASE INPUT...' prompt and a 'Browse...' button.
 - Project: PLEASE INPUT EXOB FILE NAME !
 - RW: PLEASE INPUT RECIPE FILE NAME !
 - RW_A: PLEASE INPUT RECIPE_A FILE NAME !
 - Recipe database: PLEASE INPUT RECIPE DATABASE FILE NAME !
 - Operation log: PLEASE INPUT OPERATION LOG FILE NAME !
 - Data log: PLEASE INPUT DATA LOG FILE NAME !
 - Event log: PLEASE INPUT EVENT LOG FOLDER NAME !
 - Extend Memory (EM): PLEASE INPUT EM FOLDER NAME !
- Format and Location:**
 - A checkbox for 'Use CSV (Comma Separated Values) format to save data/event log files.' is currently unchecked.
 - 'EM file location' is set to 'USB disk' (radio button selected).
- Connection:**
 - 'Ethernet' is selected as the connection method.
 - A table below shows 'IP' and 'Name' columns. The 'Name' column contains 'HMI Name:' with a dropdown arrow.
 - 'Search' and 'Search All' buttons are present below the table.
- Footer:**
 - 'Port No. Setting...' button.
 - 'Password:' field with '*****' and a checked 'Mask' checkbox.
 - 'Upload' and 'Exit' buttons.

Setting	Description
Event log	Upload the .evt file in HMI to PC.
Extended Memory (EM)	Upload the .emi file saved in SD card or USB disk to PC.

 For information about [Project], [RW / RW_A], [Recipe database] or [Data log], see “2.4.1 Download” in this chapter.

Note

- The file will be uploaded to PC in .exob format. Please decompile it into editable .empt file first and open the .empt file in EasyBuilder Pro.
- To upload the historical files saved in the external device, please use FTP. See “32 FTP Server Application” for more information.

2.5. Simulation

2.5.1. Off-line Simulation / On-line Simulation

Off-line simulation: Simulate project operation on PC without any connection.

On-line simulation: Simulate project operation on PC and PLCs are directly connected with PC.

Note

- When using [On-line simulation] on PC, if the target device is a local PLC (the PLC directly connected to PC), there is a 10 minutes simulation limit.

Before executing On-line/Off-line Simulation, please select the source .exob file.

When executing On-line/Off-line Simulation, right click to use these functions:

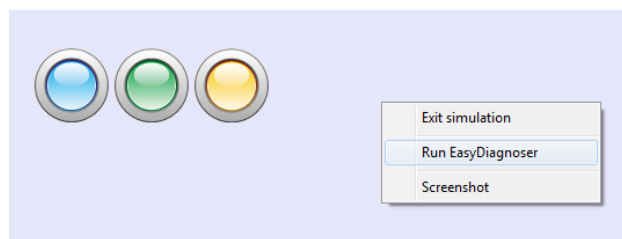

Setting	Description
Exit simulation	Stop simulating.
Run EasyDiagnoser	To monitor current communication status.
Screenshot	Capture and save current screen image as a picture file in the screenshot folder under the installation directory.

2.6. Pass-Through

This function allows the PC application to connect PLC via HMI. In this case, the HMI works like a converter.



Pass-through provides two modes: **[Ethernet]** and **[COM port]**.

When using **[Ethernet]**, please install the virtual serial port driver first.



For more detail, please refer to “Chapter 29 Pass-Through Function”.

3. Create an EasyBuilder Pro Project

This chapter explains the basic steps to create an EasyBuilder Pro project.

3.1.	Overview.....	3-2
3.2.	Create a New Project File	3-2
3.3.	Save and Compile the Project File	3-4
3.4.	Run On-Line or Off-Line Simulation.....	3-5
3.5.	cMT Viewer.....	3-5
3.6.	Download the Project File to HMI	3-6
3.7.	Upload the Project File from HMI.....	3-12

3.1. Overview

The following is the process of creating a project.

1. Create a new project file.
2. Save and compile the project file.
3. Run On-line or Off-line simulation.
4. Download the project file to HMI.

The following describes each process.

3.2. Create a New Project File

1. Launch EasyBuilder Pro and open a new file.
2. Select [Model] and select [Use template] check box.

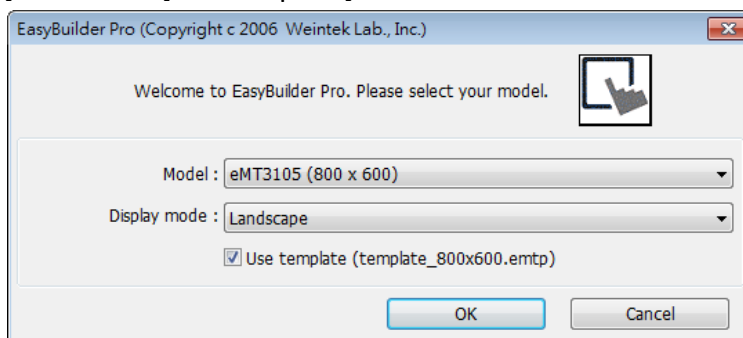

3. Click [New].

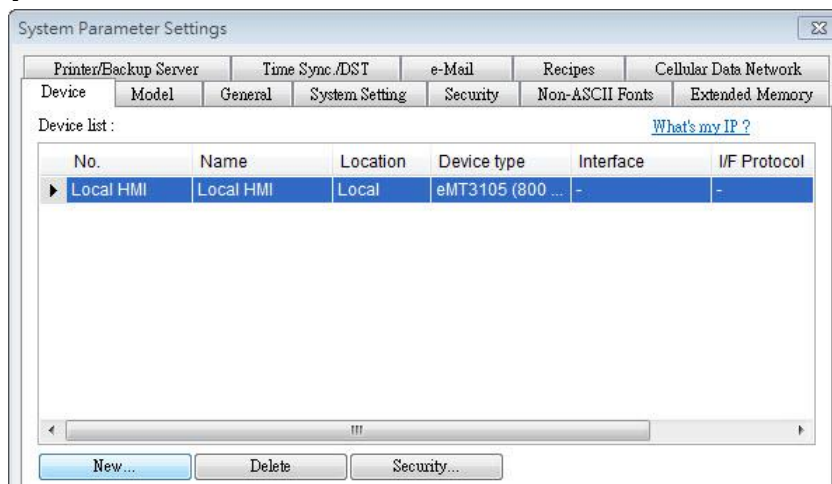

4. Configure parameters.

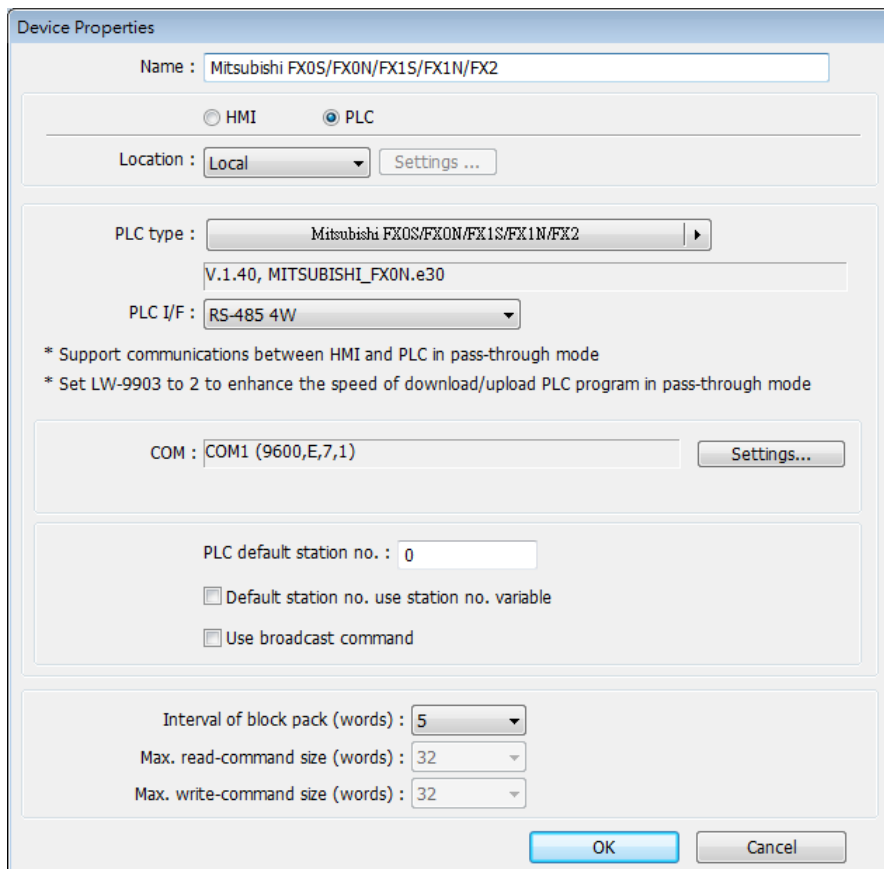

5. A new device is added to the [Device List].



6. Create an object, take Toggle Switch  as an example, and set the address.

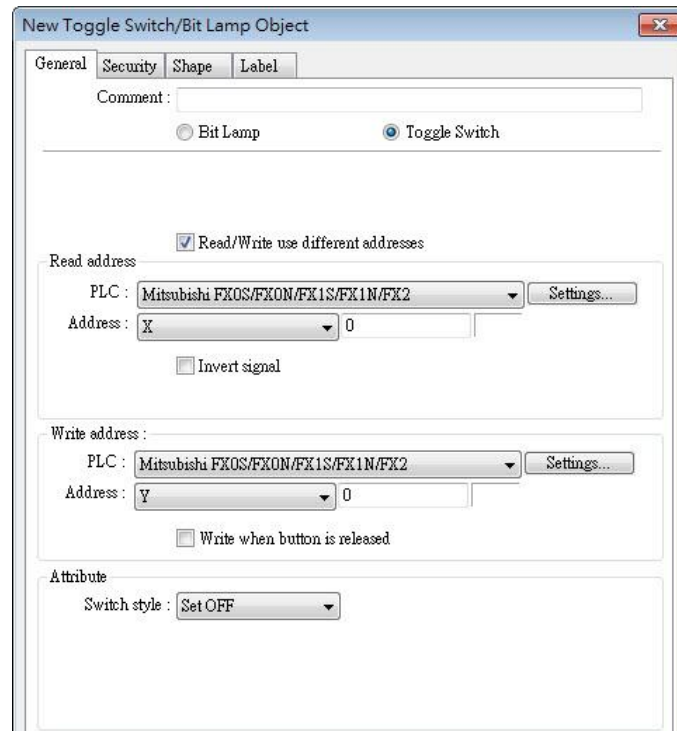

- Place the object in the edit window. A project is now created.

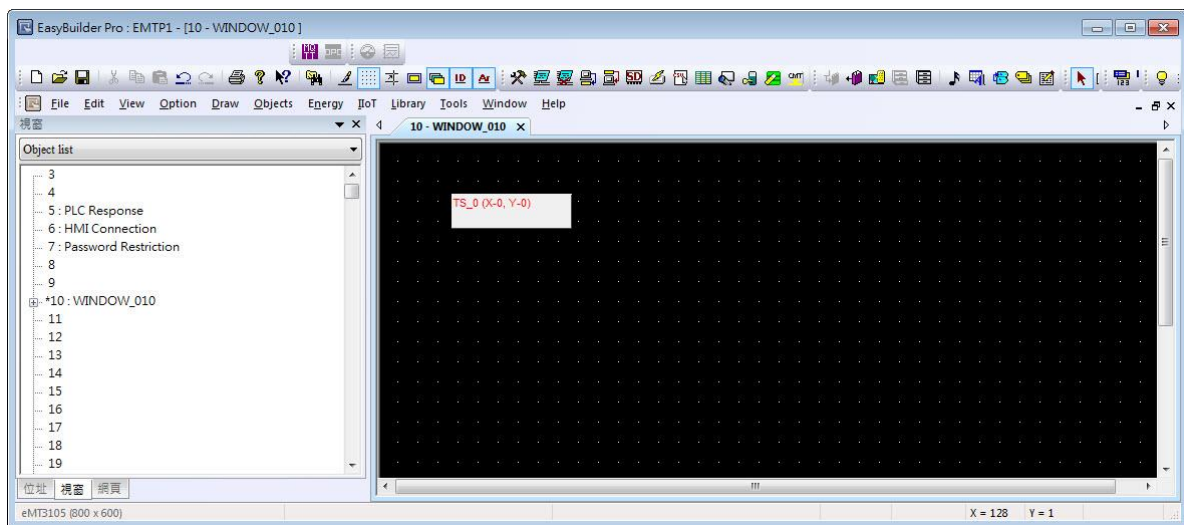

3.3. Save and Compile the Project File

- In EasyBuilder Pro toolbar click [File] » [Save] to save the .emtp file.
- In EasyBuilder Pro toolbar click [Tools] » [Compile] to compile .emtp file as .exob file, which could be downloaded to HMI. This also checks if the project can run correctly.

Note

- For cMT-SVR, the project file extension is .cmtpl, and the compiled file extension is .cxob.
- To use multiple languages, all languages must be configured in Label Tag Library first.

When downloading the project to HMI, select the needed languages only. A successful compilation is shown in the following figure.

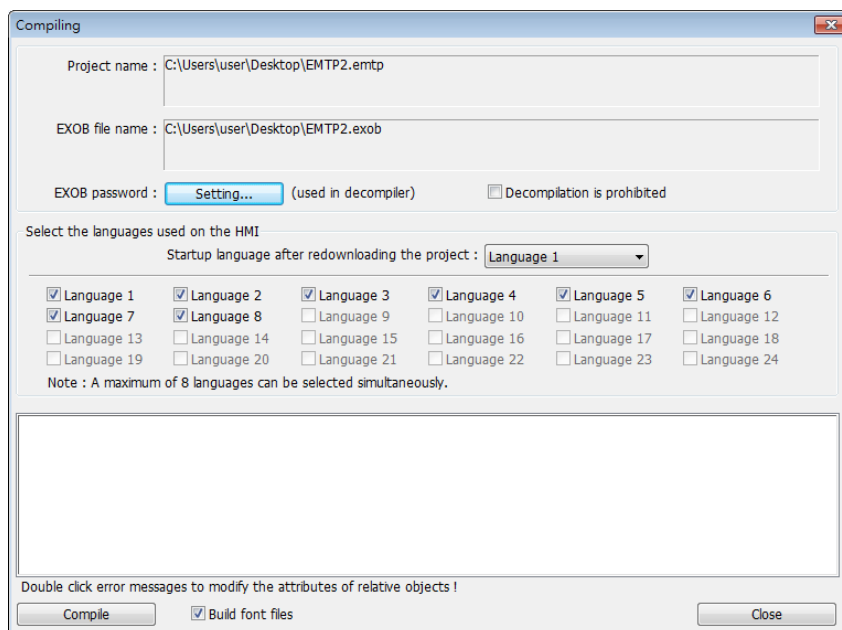

3.4. Run On-Line or Off-Line Simulation

 Off-line simulation: Simulate project operation on PC without connecting any device.

 On-line simulation: Simulate project operation on PC without downloading the project to HMI. The PLC is connected to PC, please set correct parameters.

Note

- When using On-line Simulation on PC, if the target device is the PLC directly connected to PC, there is a 10-minute simulation limit.

3.5. cMT Viewer

This program connects to cMT via network. To run this program, execute cMTViewer.exe under installation directory. Or, in EasyBuilder Pro toolbar, click [Tools] » [cMT Viewer].

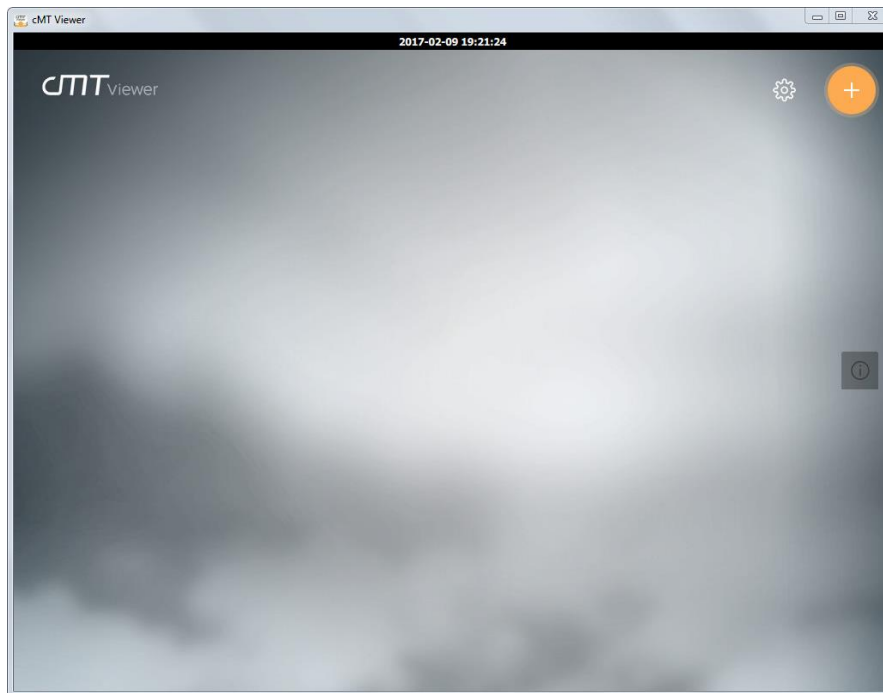

3.6. Download the Project File to HMI

The following explains four ways to download the project file to HMI.

Note

- For cMT-SVR, only the way described in 3.6.1 is available.
- When download project file to HMI using mini USB cable, please do not connect PLC simultaneously, in order to avoid noise from PLC interfering with HMI.

3.6.1. Configure in EasyBuilder Pro

1. In EasyBuilder Pro toolbar, click [Tools] » [Download]. Make sure that all the settings are correct.
2. Select [Ethernet], set password and HMI IP.

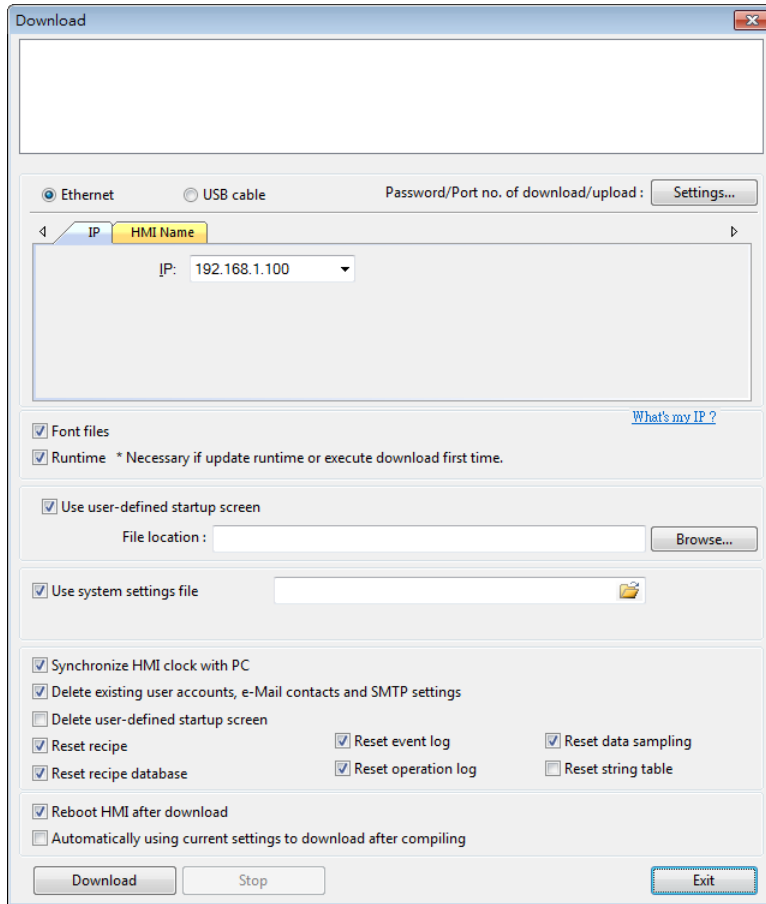

Setting	Description
Runtime	Select the check box to update the HMI kernel programs. If this is the first time downloading file or EasyBuilder Pro version is updated, please download the firmware before downloading files to HMI.
Font files	Download the font used in the project.
EasyAccess 2.0	Download EasyAccess 2.0 driver to HMI. (This option is available only for MT8000iE models. For other models, EasyAccess 2.0 will be automatically downloaded.)
Use user-defined startup screen	Use the picture selected by user as the startup screen. The picture format must be .bmp.
Use system settings file	Download the system settings file to update hardware settings.
Synchronize HMI clock with PC	Synchronize HMI time with PC time when downloading project file.
Delete existing user accounts, e-Mail contacts and SMTP settings	Select the check box to delete existing user accounts, e-Mail contacts or SMTP settings before downloading the project. This setting is only

effective when one of the following settings is enabled:

1. [System Parameter Settings] » [Security] » [Enhanced security mode] » [Use existing user accounts on HMI first (if existed), Othrewise, use settings below].
2. [System Parameter Settings] » [e-Mail] » [Use existing user accounts on HMI first (if existed), Othrewise, use settings below].

Reset recipe/ event log/ data sampling/ recipe database/ operation log/ string table/ user-defined startup screen	The selected files will be erased before downloading.
Reboot HMI after download	HMI will reboot after the downloading process is done.
Automatically using current settings to download after compiling	The system will compile the project and download it to the latest target HMI. The way to enable this function is described in the following part.

 **Note**

- For cMT-SVR, the [Firmware] and [Font files] check boxes are not available.

[Automatically using current settings to download after compiling]

If this check box is selected, EasyBuilder Pro will compile the project and download it to the latest target HMI.

1. In EasyBuilder Pro toolbar, click [Option] » [Preferences].
2. Select [Automatic save and compile when download and simulate] check box.

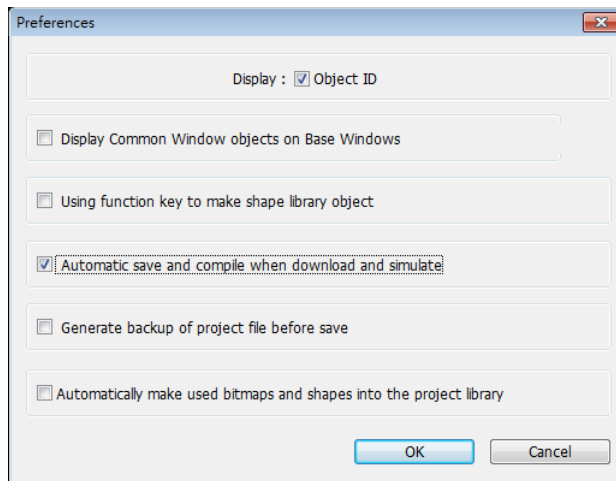

3. In EasyBuilder Pro toolbar, click [Save] and then [Download].
4. In the dialog box, select [Automatically using current settings to download after compiling] check box.
5. Click [Download].
6. When finished, next time when [Download] is clicked, EasyBuilder Pro will automatically compile and download the project to the latest target HMI.

3.6.2. Use HMI Name

1. Go to [System settings] on HMI and then set HMI name first.

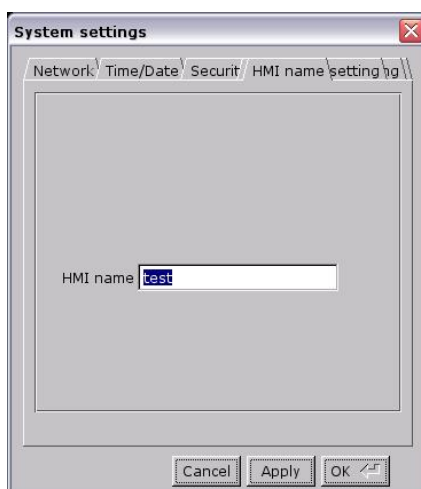

2. On PC, select the HMI name and start downloading. To use [Search], enter the HMI name first to search for the HMI. [Search all] searches for all HMIs in the same subnet network.

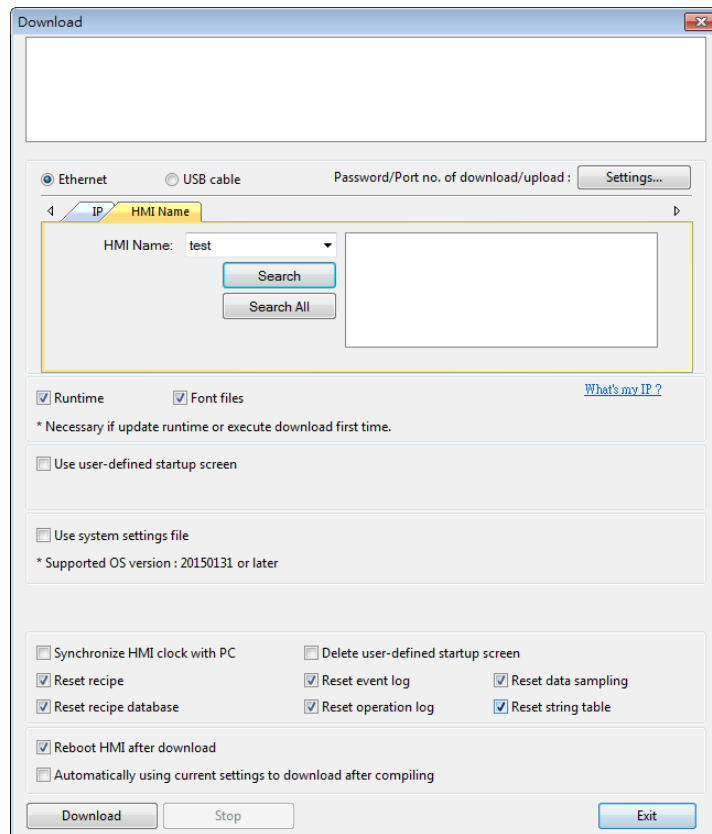

3.6.3. Use USB cable

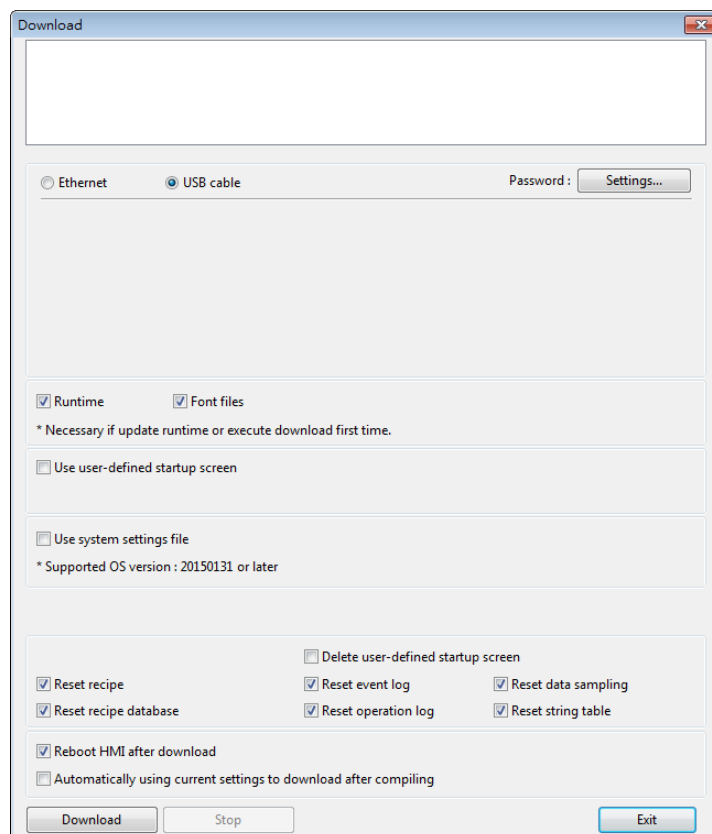

Select USB cable to download project to HMI. The way of setting is same as “3.6.1 Configure in EasyBuilder Pro”. Before downloading via USB cable, please make sure the USB driver is installed. Go to [Computer Management] » [Device Manager] to check if USB driver is installed. If it is not installed, please refer to [installation steps](#) to install manually.

3.6.4. Use USB Drive or SD Card

The following explains how to download project file by using USB drive or SD card.

1. On EasyBuilder Pro toolbar click [Tools] » [Build Download Data for SD / USB Disk].

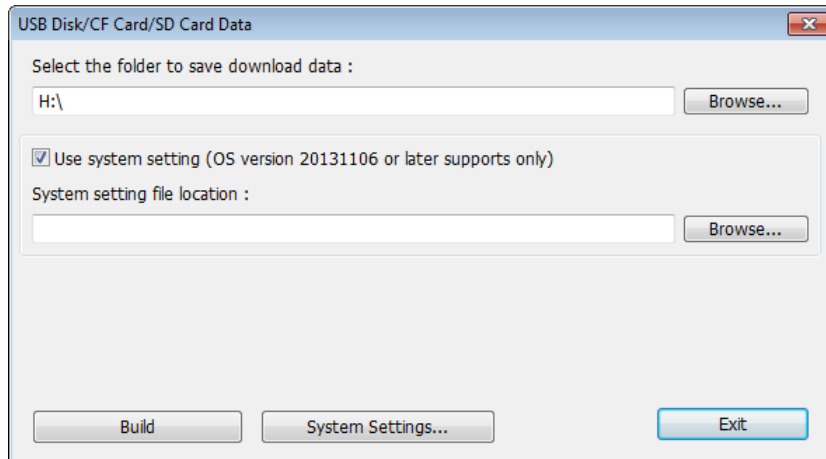

2. Insert an external device, such as SD card or USB disk to HMI.
3. Select [Download] and enter password.

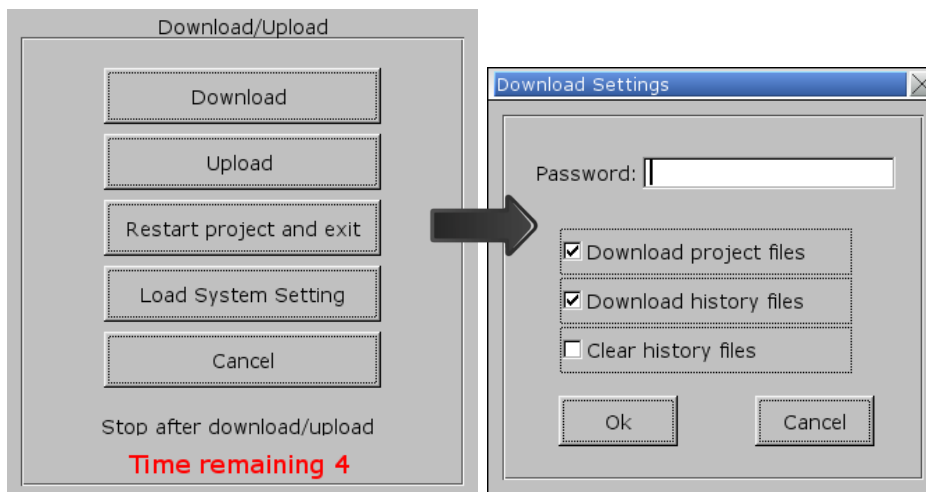

4. After password is confirmed, it will show the directories in the external device. (pccard: SD Card; usbdisk: USB Drive)

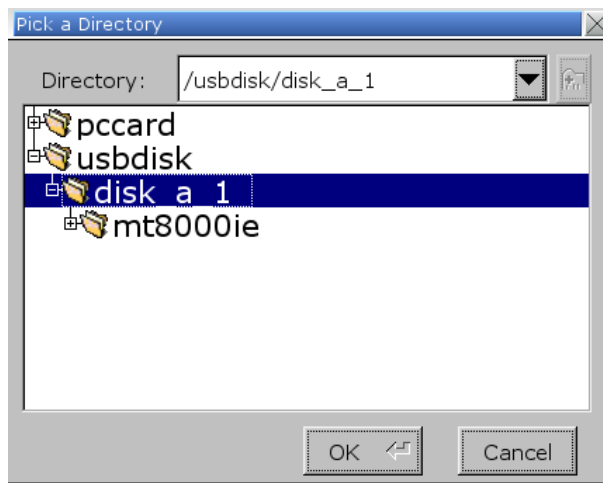

5. Select the directory that contains project, and then click [OK] to start downloading.

Note

- Please select the parent directory of the generated files when downloading. For the structure above, please select **disk_a_1**, not **mt8000ie**.
- You may click [System Settings] to save the hardware settings configured in EasyBuilder Pro into SD card or USB disk, and then download the settings file to HMI. See “4 Hardware Settings” for more information.

3.7. Upload the Project File from HMI

1. On EasyBuilder Pro toolbar click [Tools] » [Upload].
2. Set HMI IP, HMI model, project location and project name, and then click [Upload].

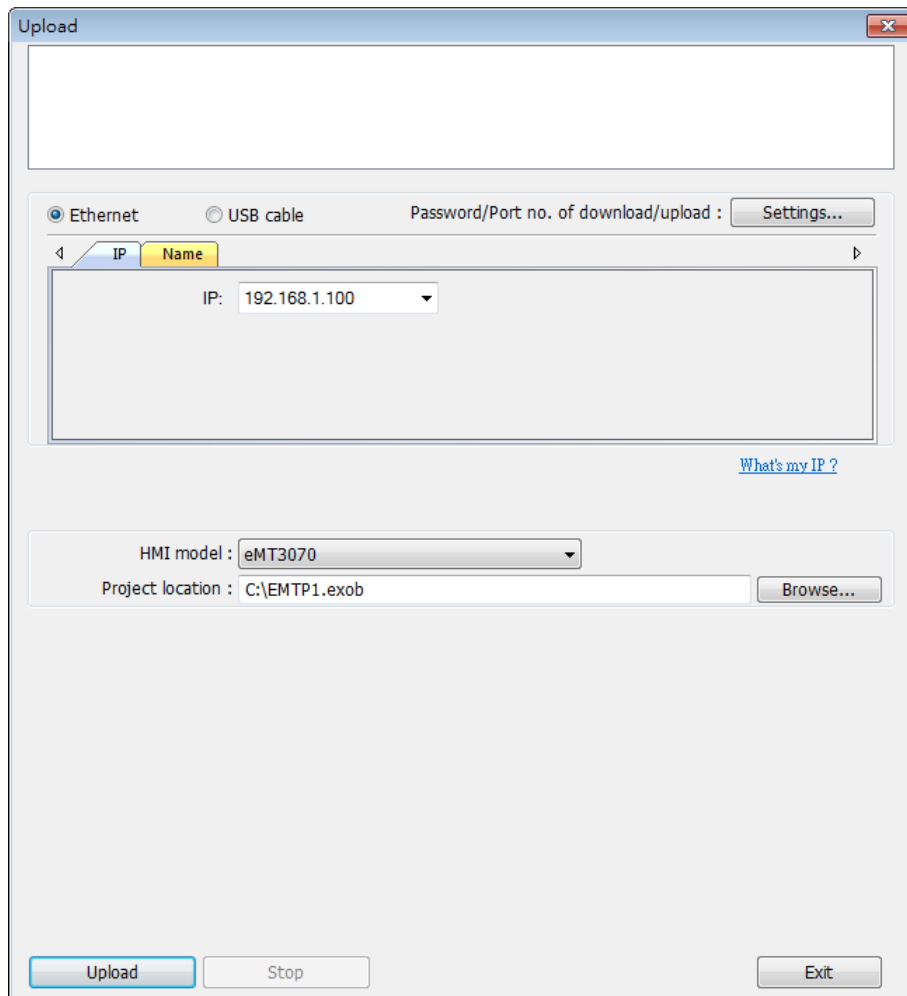

4. Hardware Settings

This chapter explains HMI settings.

4.1. Overview.....	4-2
4.2. I/O Ports.....	4-2
4.3. LED Indicators	4-2
4.4. System Reset.....	4-3
4.5. System Toolbar.....	4-4
4.6. EasySystemSetting	4-8

4.1. Overview

This chapter discusses the HMI settings.



Click the icon to download the cMT-SVR User Manual if needed.

Please confirm your internet connection before downloading the document.

4.2. I/O Ports

The I/O ports are different from one HMI type to another; please see the relevant datasheet for more information.

The I/O Ports include:

- SD card slot: Download / Upload project via SD card, including recipe transfer, event log, data log...etc and to backup or record history data.
- COM Port: Connects PLC or other peripheral devices. The type of serial port include: RS-232, RS-485 2W, RS-485 4W, and CAN Bus.
- Ethernet: Download / Upload project including recipe transfer, event log, data log...etc. Connects to Ethernet devices, such as PLC, laptop.
- USB Host: Supports USB devices, such as mouse, keyboard, USB disk, printer, or barcode device.
- USB Client: Download / Upload project including recipe transfer, event log, and data log...etc.

In addition, Weintek provides [FLZ232000 Multi-Connector Cable] and [FLZ485000 Multi-Connector Cable] to expand the COM port for easier operation.

For the first time operating HMI, please complete the following system settings. When finished, the project files designed using EasyBuilder Pro can be used on HMI.

4.3. LED Indicators

The LED indicators on the HMI indicate:

Models: MT8121XE, MT8150XE, MT8121iE, MT8150iE

LED	Description
PWR (Orange)	Indicates power status.
CPU (Green)	Blinks when read/write Flash Memory.
COM (Blue)	Indicates COM port communication status, blinks

during communication. When communication is good, it may stay on. (Not including network communication)

Other Models:

LED	Description
PWR (Orange)	Indicates power status.
CPU (Green)	Indicates CPU status. If it blinks or goes out, there may be a CPU error.
COM (Blue/Red)	Indicates communication status, blinks during communication. When communication is good, it may stay on.

4.4. System Reset

Each HMI is equipped with a reset button and a set of DIP switches. When using the DIP switches to change modes, the corresponding functions will be triggered. If system password is lost or forgotten, see the following steps to restore factory default.

1. Flip DIP Switch 1 to ON and the rest to OFF, and then reboot HMI. HMI will switch to touch screen calibration mode.
2. A “+” sign appears on the screen, touch the center of the sign, after all 5 signs are touched, “+” disappears and the touch screen parameters will be stored in HMI system.
3. After calibration, confirm to restore the default password, select [Yes].
4. Confirm to restore the default password again by typing [yes] and clicking [OK]. The project files and history records stored in HMI will all be removed. (The default Local Password is 111111. However, other passwords, such as Download/Upload passwords have to be reset.)

The following lists the DIP switch settings of different models. Please see the relevant installation instruction.

eMT / iE

Dip Switch

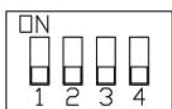

SW1	SW2	SW3	SW4	Mode
ON	OFF	OFF	OFF	Touch Screen Calibration Mode
OFF	ON	OFF	OFF	Hide HMI System Setting Bar
OFF	OFF	ON	OFF	Boot Loader Mode
OFF	OFF	OFF	ON	Reserved
OFF	OFF	OFF	OFF	Normal

 **Note**

- The state of DIP Switch 4 on each unit may be different. If it should be ON when out from factory, the Dip Switch 4 would be set ON and cut off. If it should be OFF, the Dip Switch 4 would be set OFF but the switch is not cut.

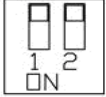
mTV	SW1	SW2	Mode
Dip Switch	ON	ON	Restore factory default
	ON	OFF	Hide system setting bar
	OFF	ON	Boot loader mode
	OFF	OFF	Normal mode

cMT-SVR	SW1	SW2	Mode
Dip Switch	ON	ON	Restore factory default
	ON	OFF	Restore Ethernet IP Settings
	OFF	ON	Boot loader mode
	OFF	OFF	Normal mode

4.5. System Toolbar

After rebooting HMI, you can set the system with [System Toolbar] at the bottom of the screen. Normally, this bar is hidden automatically. Only by touching the arrow icon at the bottom-right corner of the screen will the System Toolbar pop up. From left to right the icons are: System Settings, System Information, Text Keyboard, and Number Keyboard.



How to hide HMI System Setting Toolbar:

- When [DIP Switch 2] is set ON, the system setting toolbar is disabled. When set OFF; the system setting toolbar is enabled. Please restart HMI to enable/disable the toolbar.
- For mTV Series, flip DIP Switch 1 to ON to hide system setting toolbar.
- System register [LB-9020] can also enable/disable system setting toolbar. When [LB-9020] is set ON, the toolbar is displayed, and set OFF to hide the toolbar.

4.5.1. System Setting

Set or modify system parameters. Confirm password for security first. The factory default password is 111111.

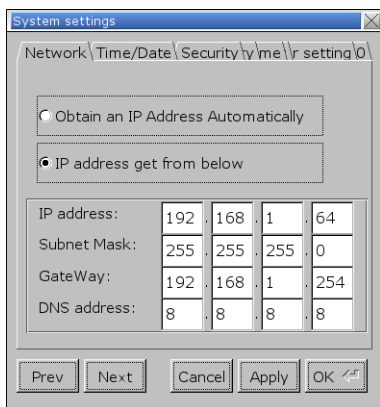

Network

When downloading project file to HMI via Ethernet, set the correct IP of the target HMI. You can obtain an IP address automatically or enter the IP address manually. To use Email and EasyAccess2.0, please set correct DNS address.

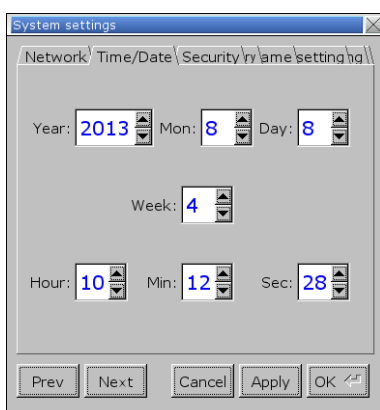

Time / Date

Set HMI local time/date.



Security

Password protection, the default is 111111. Please click the buttons to set the passwords, and finish password confirmation.

- [Password for entering system]
- [Password for uploading project]
- [Password for downloading project]
- [Password for uploading history data]

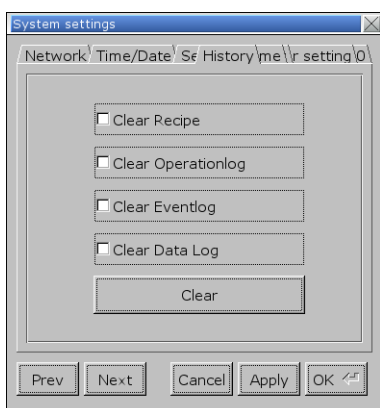

History

Clears history data in HMI.

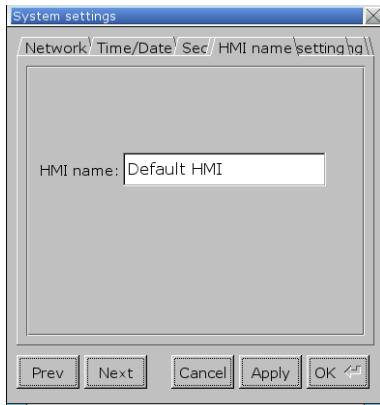

HMI name

Set HMI name to be used when download/upload project.

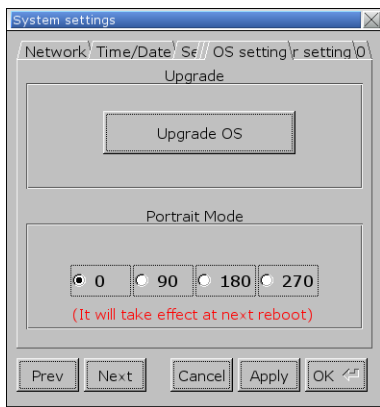

Firmware setting

[Upgrade OS]

Upgrade firmware. Please do not turn off or unplug HMI during OS upgrade process. For more details, see the instruction about OS upgrade of the model used.

[Portrait Mode]

Set screen orientation mode. After changing the mode, reconnect HMI to power supply, for the setting to take effect. That is, disconnect all power from HMI, and then connect again. If portrait mode is used (90 or 270 degree), the project must be designed for portrait mode, otherwise it cannot be correctly displayed.

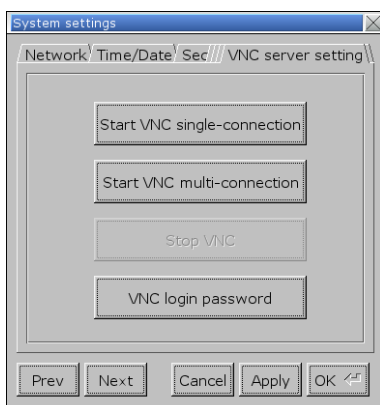

VNC server

Remote HMI monitoring and controlling via Ethernet.

[Start VNC single-connection]

Allows connection with one VNC client.

[Start VNC multi-connection]

Allows connection with multiple VNC clients.

Connecting more VNC clients may slow down the communication speed.

Please see the settings steps in the later part.

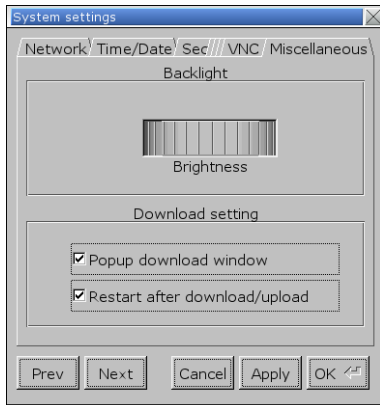

Miscellaneous

Rotary switch for adjusting LCD brightness.

[Popup download window]

If selected, after inserting USB disk or SD card to HMI, the Upload / Download dialog box is displayed.

[Restart after download/upload]

If selected, restarts HMI automatically after uploading / downloading project.

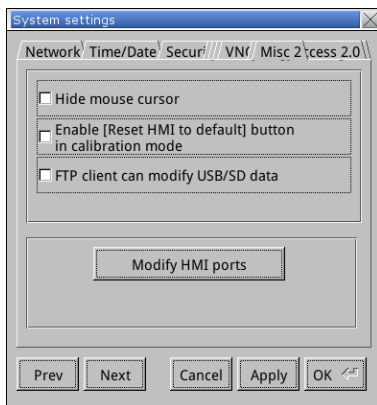

Misc 2

[Hide mouse cursor]

If selected, the mouse cursor will be hidden.

[Enable [Reset HMI to default] button in calibration mode]

If selected, when the operator presses and holds anywhere on the screen for more than 2 seconds during HMI startup, the touch screen calibration mode will start. After calibration, [Reset HMI to default] option shows.

[FTP client can modify USB/SD data]

If selected, USB/SD data can be modified using FTP.

[Modify HMI ports]

Change the port number for Upload/Download and FTP.

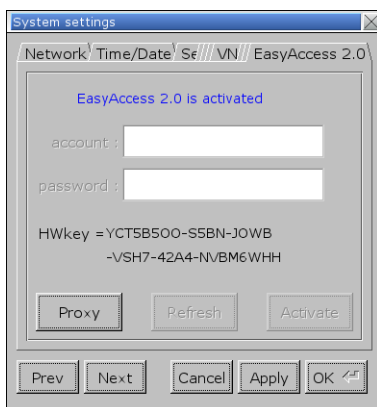

EasyAccess 2.0

Activate EasyAccess 2.0 service.

The following steps explain how to set VNC server.

1. Enable HMI VNC server, set password.
2. Install Java IE or VNC Viewer on PC.
3. Enter remote HMI IP in Internet Browser. Or, in VNC Viewer enter remote HMI IP and password.



4.5.2. System Information

Network: Displays network information & HMI IP.

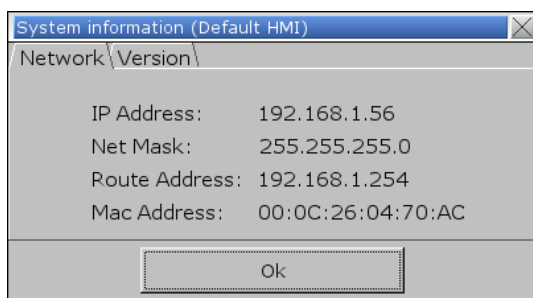

Version: Displays HMI firmware version and model type.

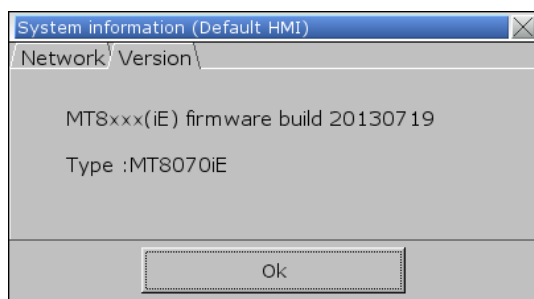

4.6. EasySystemSetting

EasySystemSetting allows updating hardware system settings by using SD card or USB drive. The feature is available for HMI OS version 20131106 or later.

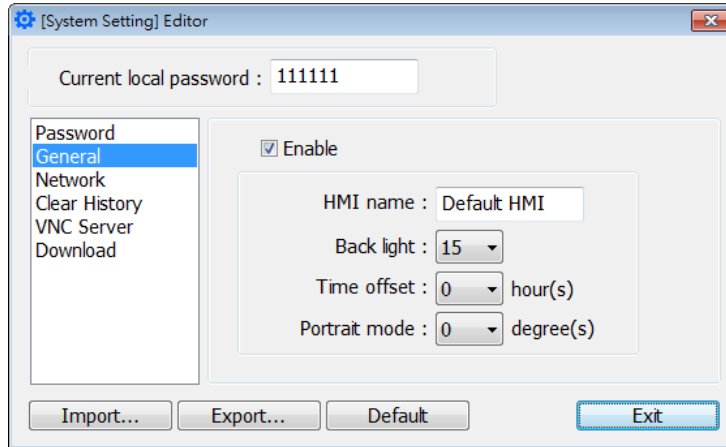

Setting	Description
General	<p>[HMI name] Enter HMI name.</p> <p>[Back light] Adjust LCD backlight brightness.</p> <p>[Time offset] Set the HMI RTC with offset. For example, if the current RTC time is 15:00:00, and the time offset is set to -3, the updated time will be 12:00:00.</p> <p>[Portrait mode] Set the display mode.</p>
Import	Import and edit an existing .conf file.
Export	Export the configured data to a .conf file.
Default	Restore default.

The following explains how to update HMI IP address by using SD card or USB drive.

1. On EasyBuilder Pro toolbar click [Tools] » [Build Download Data for SD / USB Disk], and then select [Use system setting] check box.

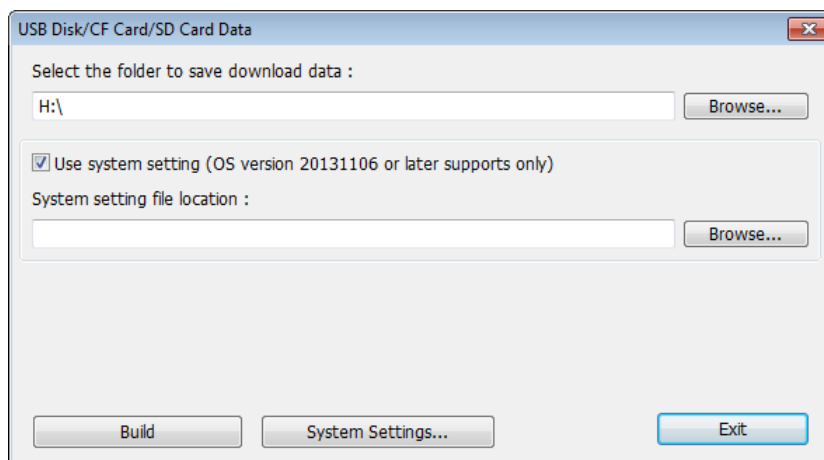

2. Click [System Settings] button to open [System Setting] Editor dialog box. Specify HMI network information as shown in the following figure.

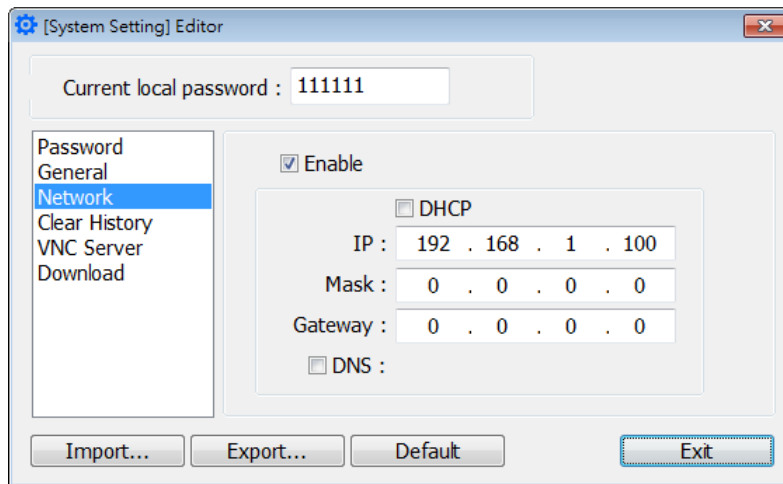

3. Click [Export] to generate a "systemsetting.conf" file.
4. Click [Exit] to leave EasySystemSetting.
5. Click [Build] button in [USB Disk/CF Card/SD Card Data] dialog box to generate the file for download by using SD card or USB disk.
6. Insert the storage device that stores the download file to HMI and the Download/Upload dialog box appears.

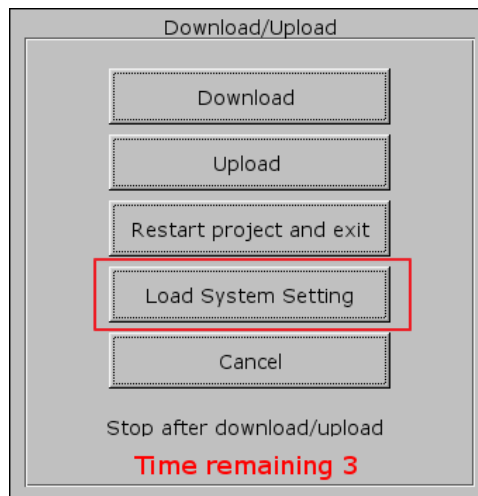

7. Press [Load System setting] and then the [Download Config Settings] message appears. The project file will be updated after finishing system settings.

5. System Parameter Settings

This chapter introduces the system parameter settings.

5.1.	Overview.....	5-2
5.2.	Device	5-2
5.3.	Model.....	5-11
5.4.	General	5-14
5.5.	System Setting	5-17
5.6.	Security	5-19
5.7.	Font.....	5-22
5.8.	Extended Memory	5-24
5.9.	Printer / Backup Server.....	5-26
5.10.	Time Sync./DST	5-27
5.11.	e-Mail.....	5-28
5.12.	Recipes.....	5-31
5.13.	Cellular Data Network	5-32

5.1. Overview

Launch EasyBuilder Pro, in the main menu select [Edit] » [System Parameters] to open the [System Parameter Settings] dialog box. System Parameter Settings are divided into several tabs as shown in the following figures. These tabs will be introduced respectively in this chapter.

eMT, iE, XE, mTV Series

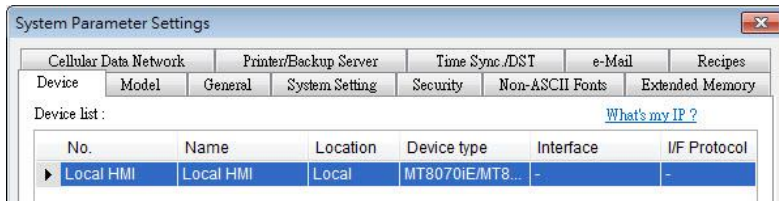

cMT Series

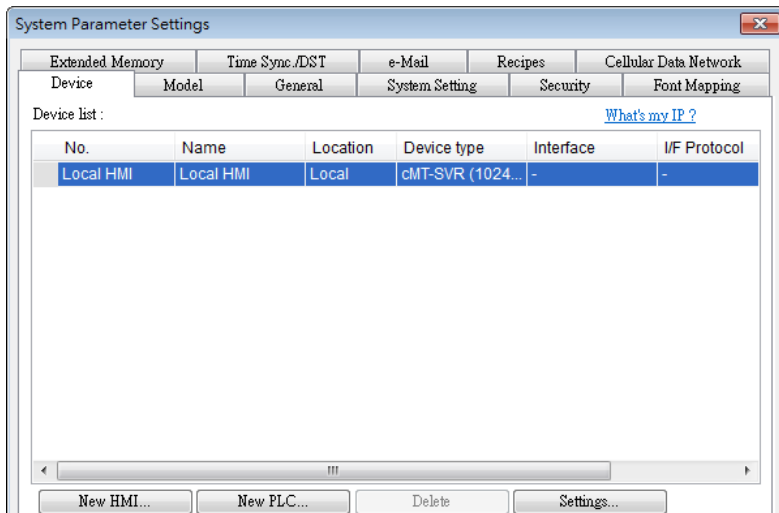

5.2. Device

Parameters in this tab determine the attributes of each device connected with HMI. The device can be a Local / Remote HMI / PLC. When creating a new project file, there is a default device "Local HMI" which indicates the HMI that will be updated and programmed. To change the relevant device settings, click [System Parameter Settings] » [Settings] to open [Device Properties] dialog box.

5.2.1. How to Control a Local PLC



“Local PLC” means the PLC is connected to the local HMI. To control/connect a Local PLC, add this type of device first. Click [System Parameter Settings] » [New] to open [Device Properties] dialog box. For example, when connecting MODBUS RTU as a Local PLC:

The screenshot shows the 'Device Properties' dialog box with the following settings:

- Name: MODBUS RTU
- Device Type: HMI, PLC
- Location: Local
- PLC type: MODBUS RTU
- Protocol: V.2.50, MODBUS_RTU.e30
- PLC I/F: RS-232
- COM: COM1 (9600,E,8,1)
- PLC default station no.: 1
- Interval of block pack (words): 5
- Max. read-command size (words): 120
- Max. write-command size (words): 120

Setting	Description
Name	The name of the device.
HMI / PLC	In this example the device used is a PLC, so select [PLC].
Location	Select [Local] or [Remote]. In this example the PLC is connected to the Local HMI, so select [Local].
PLC type	Select the type of the PLC.
PLC I/F	The available PLC interface: [RS-232], [RS-485 2W], [RS-485 4W], [Ethernet], [USB], and [CAN Bus]. <ul style="list-style-type: none"> ● If the interface used is [RS-232], [RS-485 2W], or [RS-485 4W], configure communication parameters by clicking [Device Properties] » [Settings] and then [Com Port Settings] dialog box opens.

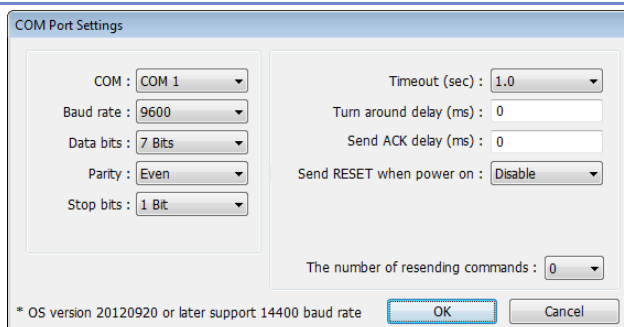

Timeout

If the communication has been disconnected for more than preset time limit configured in [Timeout] (in sec), Window No. 5 will pop up and show “PLC No Response” message.

Turn around delay

While sending the next command to PLC, HMI will delay the sending according to the time interval set in [Turn around delay]. This may influence the efficiency of the communication between HMI and PLC. Default value is “0”.

Note: If the PLC used is SIEMENS S7-200 Series, it is recommended to assign “5” to [Turn around delay] and “30” to [Send ACK delay].

- If the interface used is [Ethernet], click [Device Properties] » [Settings] and the [IP Address Settings] dialog box opens. Please set correct PLC IP address and port number.

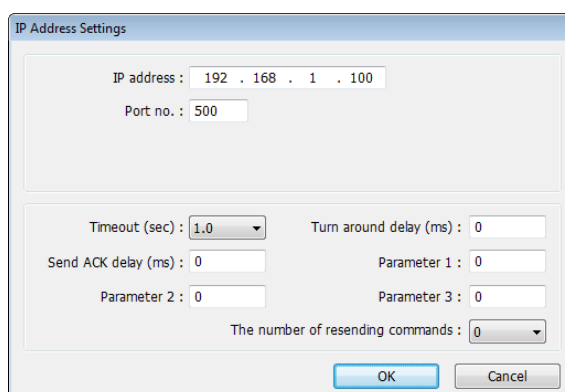

- If the interface is [USB], no further setting is required. Please check the settings in [Device Properties].
- If the interface is [CAN (Controller Area Network)]

Bus], please see “PLC Connect Guide” for “CANopen” and import the .eds device file.

PLC default station no.

The default station number for PLC address if the PLC station number is not included in the address. PLC station no. can be set in PLC address. The address format: ABC#DEFGH
 ABC stands for PLC station number and ranges from 0 to 255. DEFGH stands for PLC address. And the “#” sign separates the station number and the address. As shown in the following figure, the data is read from PLC station number 1, and address 0x-20.

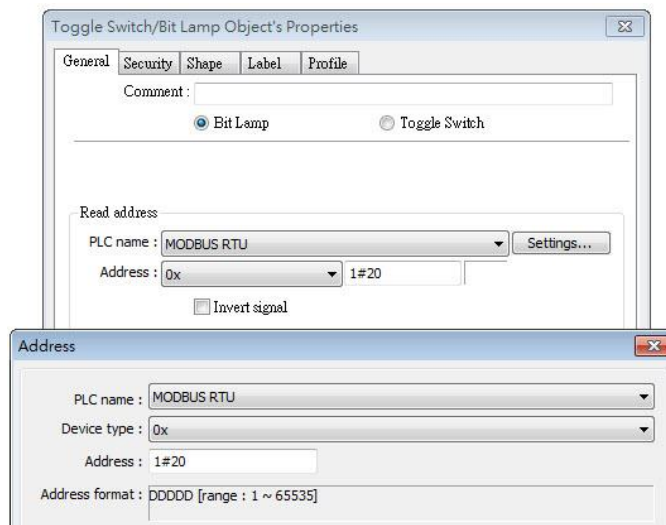

Default station no. use station no. variable

Use the station number variables as the default PLC station number. Select one from LW-10000 to LW-10015 (var0 to var15) as the station number variables. If the station no. is not specified in PLC address, the station number will be determined by the station no. variable. For example, if var3 is set for default station no:

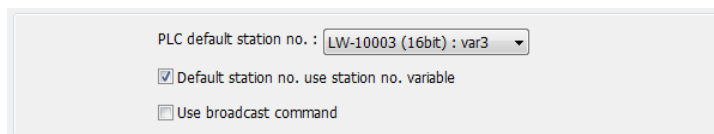

The followings demonstrate some examples:

- The PLC station number is “5”.

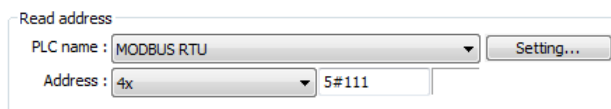

- The PLC station number is determined by var7 (LW-10007)

- PLC address is set to “111”, since PLC station no. is not specified, and the default station no. is var3, the PLC station no. is determined by var3 (LW-10003).

Use broadcast command

When [Use broadcast command] check box is selected, please fill in [Broadcast station no.] according to the broadcast station number defined by PLC. When HMI sends a broadcast command to the station number set here, PLC will only receive the command and not reply to HMI.

As shown in the following figure:

When HMI sends a command to address 255#200, all the PLCs will receive this command and will not reply. Only PLCs that support broadcast command can use this feature.

Interval of block pack (words)

If the interval between read addresses of different commands is less than this value, the commands can be combined to one. The combining function is disabled if this value is set to “0”.

For example, the interval value is set to “5”, to read 1 word from LW-3 and 2 words from LW-6 respectively (read from LW-6 to LW-7), since the interval of addresses between LW-3 and LW-6 is less than 5, these two commands can be combined to one. The result is to read 5 consecutive words from LW-3 to LW-7.

Note: The maximum size of command combination data must be less than [Max. read-command size].

Max. read - command size (words) The maximum data size to read from the device at one time. Unit: word

Max. write - command size (words) The maximum data size to write to the device at one time. Unit: word.

After all settings are completed, a new device named “Local PLC 1” is added to the [Device list].

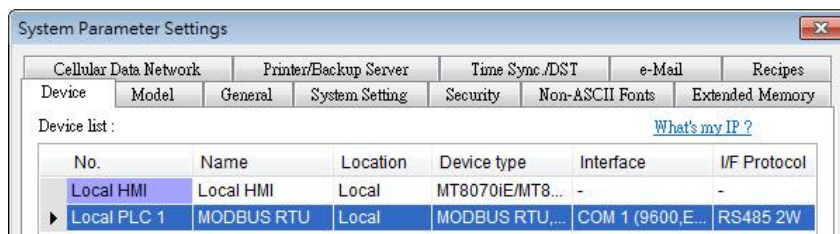

Note

- When using cMT, select “Local HMI” in [System Parameter Settings] dialog box and then click [New PLC] to add a “Local PLC 1” under “Local HMI”.

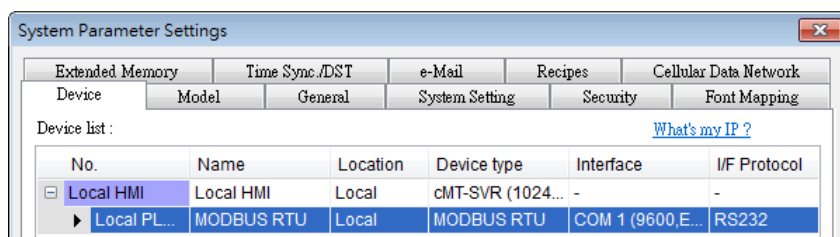

5.2.2. How to Control a Remote PLC



“Remote PLC” is a PLC being connected to a remote HMI. To control a remote PLC, add this type of device first. Please click [System Parameter Settings] » [New] to open [Device Properties] dialog box. For example, use MODBUS RTU as the Remote PLC:

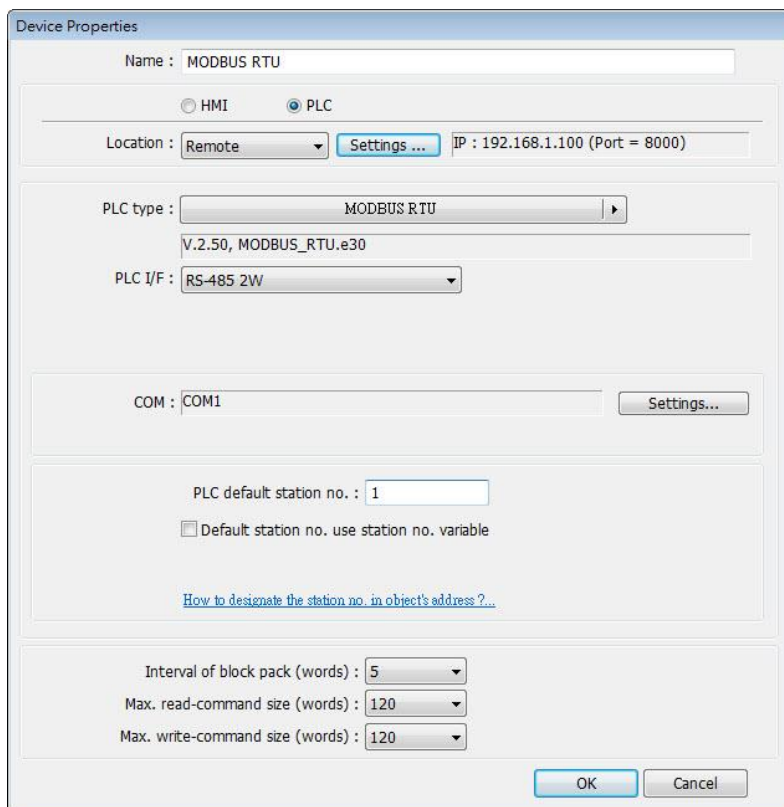

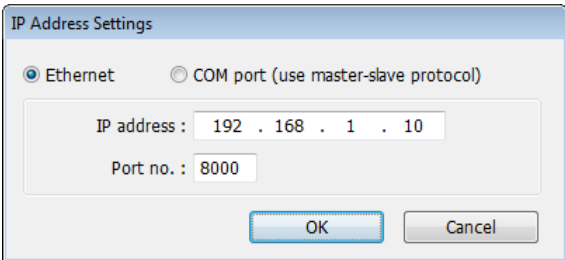
Setting	Description
HMI or PLC	In this example, the device used is a PLC, so select [PLC].
Location	Select [Local] or [Remote]. In this example the PLC is connected to Remote HMI, so select [Remote]. Set the IP address and port number of the Remote HMI by clicking [Settings] next to [Remote].
	
PLC Type	Select the type of the PLC.
PLC I/F	The interface used for Remote PLC. If the remote PLC uses a COM port, select [RS-232], [RS-485 2W], or [RS485 4W].
COM	Set the correct COM port used by the Remote PLC.
PLC default station no.	Set the station number of Remote PLC.

After all settings are completed, a new device named “Remote PLC 1” is added to the [Device list].

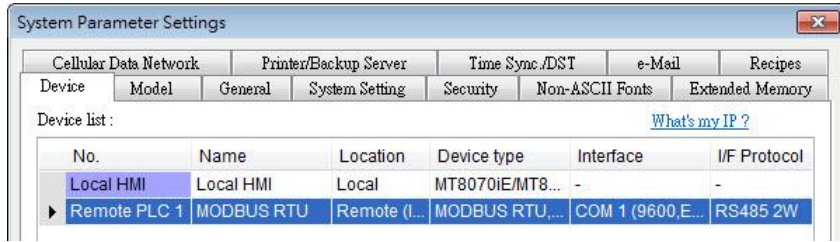

Note

- When using cMT-SVR, select the defined “Remote HMI 1” in [System Parameter Settings] dialog box and then click [New PLC] to add a “Remote PLC 1” under “Remote HMI 1”.

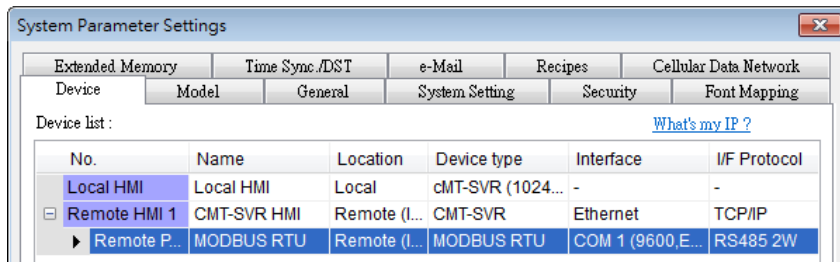

5.2.3. How to Control a Remote HMI



“Remote HMI” is the HMI other than “Local HMI”, and PC is also a “Remote HMI”. To control a Remote HMI, add this type of device first. Click [System Parameter Settings] » [New] to open [Device Properties] dialog box as shown in the following figure:

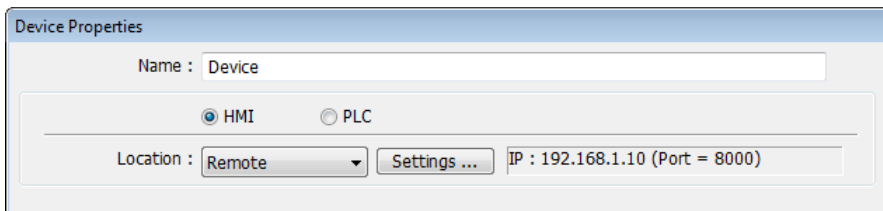

Setting	Description
HMI or PLC	In this example, the device used is a HMI, so select [HMI].
Location	Select [Local] or [Remote]. In this example Remote HMI is used, select [Remote]. Set the IP address and port number of the Remote HMI by clicking [Device Properties] » [Settings].

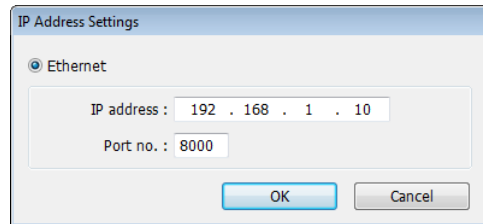

After all settings are completed, a new device named “Remote HMI 1” is added to the [Device list].

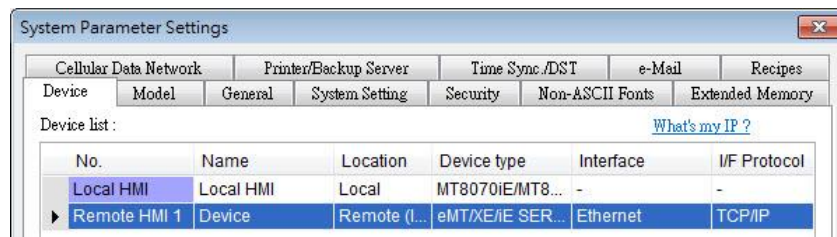

Note

- When using cMT-SVR, in [System Parameter Settings] dialog box click [New HMI] to add a “Remote HMI 1”.

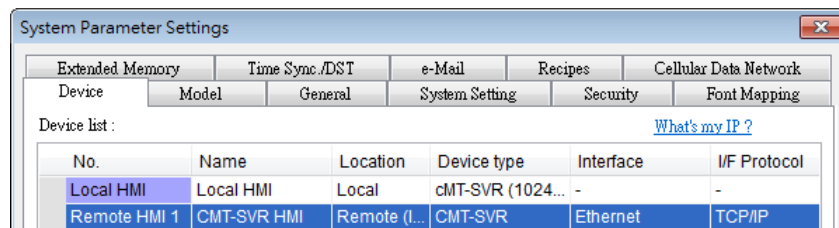

5.3. Model

Configure the [HMI model], [Timer], [Printer] and [Scroll bar] settings.

eMT、iE、XE、mTV Series

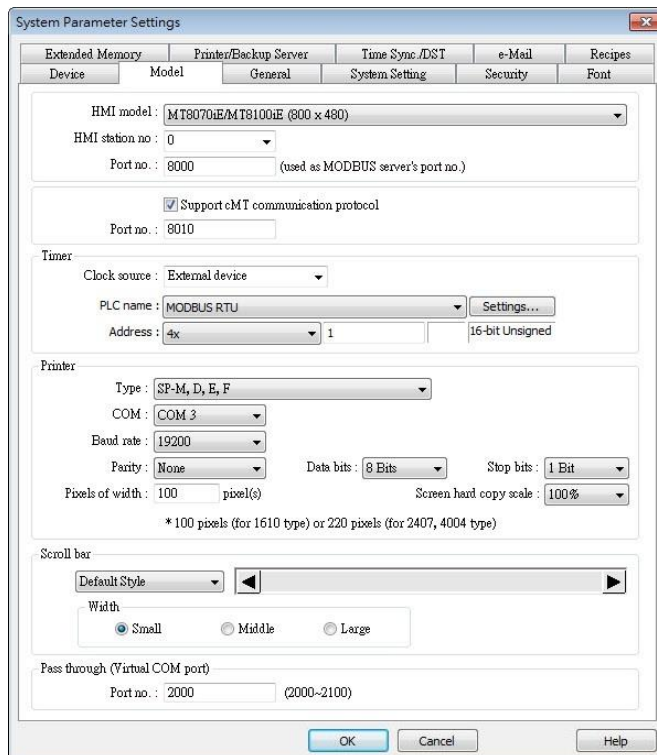

cMT3151

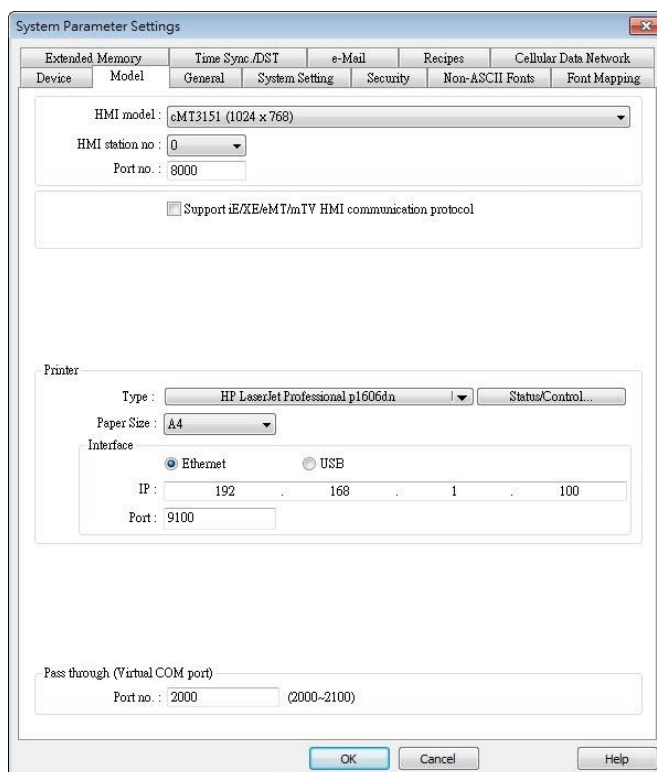

 **Note**

- When using cMT-SVR, configure only [HMI model], [HMI station no.], and [Port no.].

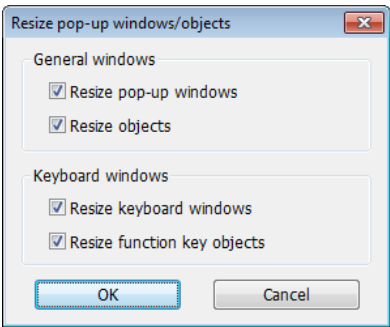
Setting	Description												
HMI model	<p>Select the HMI model to use.</p> <p>If the HMI model is changed, the [Resize pop-up windows / objects] dialog box will pop up. Select required adjustment and click [OK]. In most cases, select all options.</p> 												
HMI station no.	Set the station number of current HMI. The default value is "0".												
Port no.	Set the port number of current HMI. It is also used in MODBUS server. The default value is "8000".												
Support cMT Viewer communication protocol	Supports cMT Viewer using this HMI as a Remote HMI. The Remote HMI port number in cMT-SVR project must be identical to the port number set here.												
Timer	<p>Clock source</p> <p>Set the source device of the clock/time information. It is used by [Data Sampling], [Event Log], etc.</p> <ul style="list-style-type: none"> ● If [HMI RTC] is selected, the time information comes from the internal clock of the HMI. ● If [External device] is selected, the time information comes from an external device. The address of the source device must set correctly. As shown below, the time information is from "TV" address type of the "Local PLC". The addresses of "TV" start from 0 and contain 6 consecutive words and each of them store the following information: <table data-bbox="619 1883 1118 1998"> <tbody> <tr> <td>TV</td> <td>0</td> <td>→</td> <td>Second (range: 0~59)</td> </tr> <tr> <td>TV</td> <td>1</td> <td>→</td> <td>Minute (range: 0~59)</td> </tr> <tr> <td>TV</td> <td>2</td> <td>→</td> <td>Hour (range: 0~23)</td> </tr> </tbody> </table>	TV	0	→	Second (range: 0~59)	TV	1	→	Minute (range: 0~59)	TV	2	→	Hour (range: 0~23)
TV	0	→	Second (range: 0~59)										
TV	1	→	Minute (range: 0~59)										
TV	2	→	Hour (range: 0~23)										

- TV 3 → Day (range: 1~31)
- TV 4 → Month (range: 1~12)
- TV 5 → Year (range: 1970~2037)

Printer (eMT, iE, XE, mTV)

Type

A printer can be connected with the HMI. The HP PCL Series printer is connected through USB interface while other printers through a COM port.

For more information, see “23 HMI Supported Printers”.

If the printer is connected through [COM], configure the parameters correctly. If the printer type is [SP-M, D, E, F], the [pixels of width] has to be set accurately, i.e. the set pixel(s) cannot exceed printer’s default setting, or the HMI will fail to print data.

Printer (cMT3151)

The printer driver can be installed on HMI.

Type

Select printer type.

Status address

Shows printer status.

LW-n	Status
0	Printer driver is not installed yet.
1	Installing printer driver.
2	Printer is ready.
3	Printer is printing.
LW-n+1	Error
0	None
1	Printer is not found.
2	Unknown error.

Control address

Updates printer connection parameters.

LW-n	Command
0	Printer driver is not installed yet.
1	Update connection parameters.
LW-n+1	I/O
0	Ethernet
1	USB
LW-n+2	IP address (Total: 4 words)
LW-n+6	Port (Default port number: 9100)

Scroll bar Set the width of Scroll Bar, when the size of the object is too small to display the contents, a scroll bar is displayed in the object. This feature can be applied to objects that allow scrolling, such as Alarm Display, Event Display, History Data Display, and Option List.

Pass through Set the port number for Pass-through communication.

5.4. General

Configure the properties related to screen display.

eMT, iE, XE, mTV Series

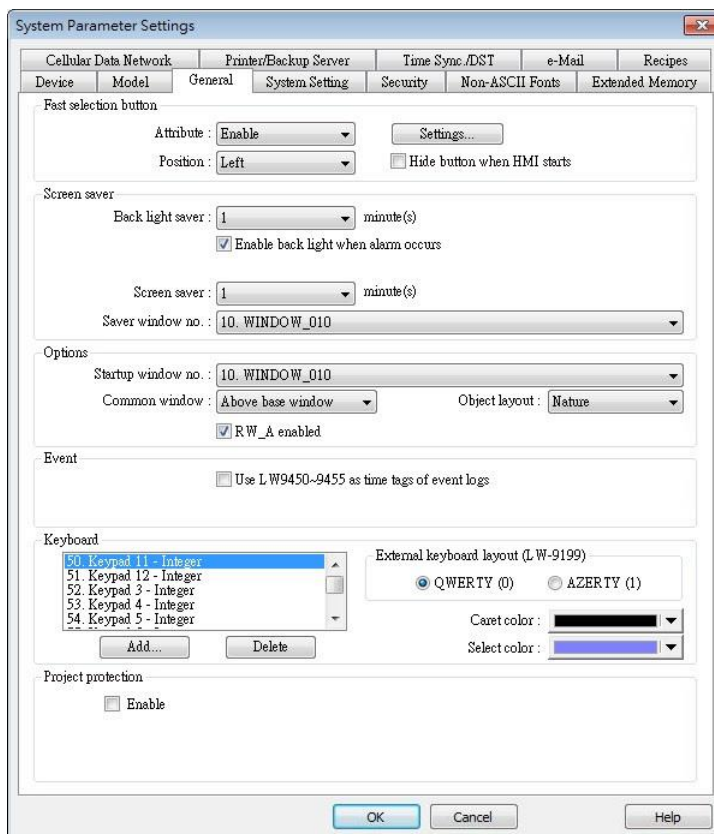

cMT-SVR

cMT3151

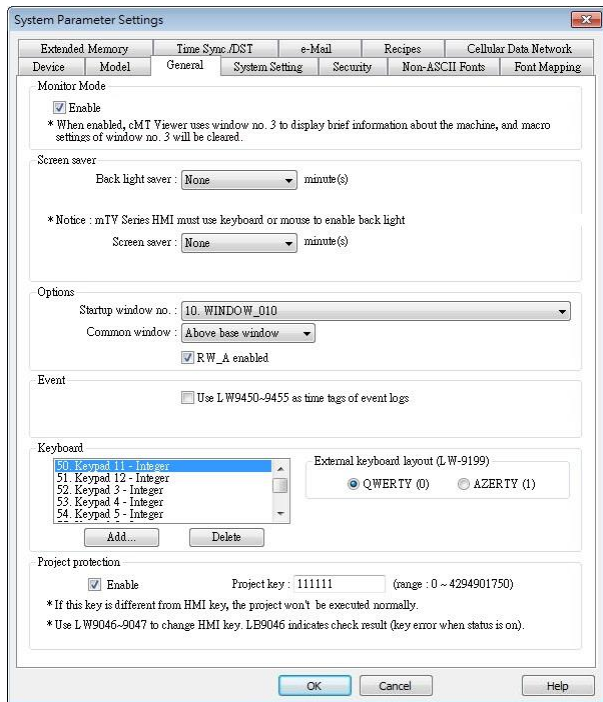
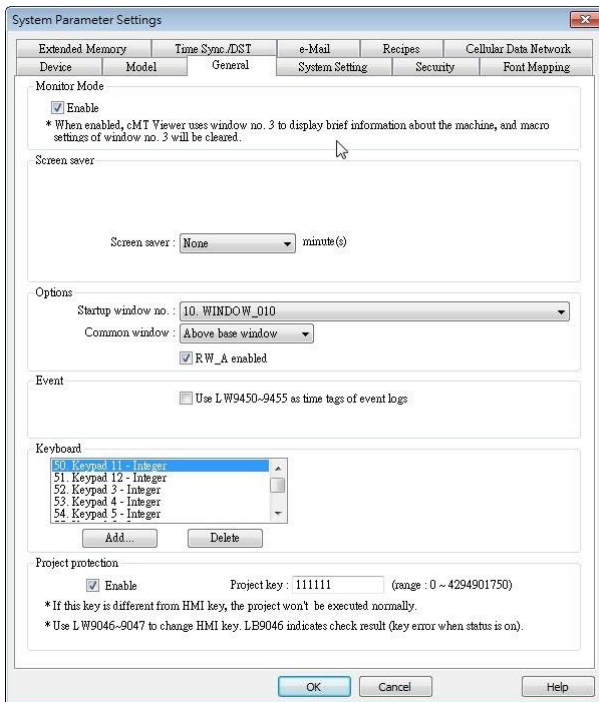

Setting	Description
Fast selection button	<p>This setting is applicable for eMT, iE, XE mTV Series.</p> <p>Setting the attributes for fast selection button for Window No. 3. To use the fast selection button, create Window No. 3 first.</p> <p>Attribute Enable or disable fast selection window. Select [Enable] and click [Settings] to set the attributes, including color and text of the button.</p> <p>Position Select the button position on the screen. If [Left] is chosen, the button will show up in at bottom left side of the screen; if [Right] is chosen, the button will show at the bottom right side of the screen.</p> <p>Settings Set the shape and label font of the Fast Selection Button.</p> <p>Hide button when HMI starts The Fast Selection Button will be hidden, calling it out requires system registers LB-9013~LB-9015.</p>
Monitor Mode	<p>This setting is applicable for cMT Series.</p> <p>Window no. 3 in the project is monitored in this mode in cMT Viewer. The user can select up to 50 cMT Series HMIs to monitor in cMT Viewer, and in 3x3 or 5x4 tile view.</p>
Screen saver	Back light saver

Option	<p>If the screen is left untouched and reaches the time limit set here, the back light will be turned off. The unit is minute. Back light will be on again once the screen is touched. If [none] is set, the back light will always be on.</p> <p>Screen saver</p> <p>If the screen is left untouched and reaches the time limit set here. The current screen will automatically switch to a window assigned in [Saver window no.].The setting unit is minute. If [none] is set, this feature is disabled.</p> <p>Saver window no.</p> <p>To assign a window for screen saver.</p>
Option	<p>Startup window no.</p> <p>Designate the window shown when start up HMI.</p> <p>Common window</p> <p>The objects in the common window (Window No. 4) will be shown in each base window. This determines that the objects in common window are placed above or below the objects in the base window.</p> <p>Object layout</p> <p>If [Control] mode is selected, when operating HMI, [Animation] and [Moving Shape] objects will be displayed above other kinds of objects neglecting the sequence that the objects are created. If [Nature] mode is selected, the display will follow the sequence that the objects are created, the first created will be displayed first.</p> <p>RW_A enabled</p> <p>Enable or disable recipe data RW_A. Enable this, the objects can then control RW_A .The size of RW_A is 64K.</p>
Event	<p>Extra no. of events</p> <p>The default number of the events in the system is 1000. For additional number of events, modify this setting. The maximal is 10000.</p>
Keyboard	<p>The window number in which the keyboard is placed.</p> <p>When using Numeric Input or ASCII Input objects, the type of keyboards can be selected. Up to 32 keyboards can be added. To design a keyboard, a window should be designated for creating it. Press [add] after creating, and add the window to the list.</p> <p> See “12 Keyboard Design and Usage”.</p> <p>External keyboard layout</p> <p>Applicable for eMT, iE, XE, mTV, and cMT 3151 models.</p> <p>The available USB keyboard layouts are QWERTY and</p>

AZERTY. System register LW-9199 allows switching keyboard layouts on HMI.

Caret color / Select color

This setting is applicable for eMT, iE, XE, and mTV Series. Set the color of caret that appears when entering data in Numeric Input and ASCII Input objects, or change the selection color.

Project protection

Projects can be restricted to be executed by a specific HMI.  See “30 Project Protection”.

5.5. System Setting

[System Setting] is used to configure different features of EasyBuilder Pro.

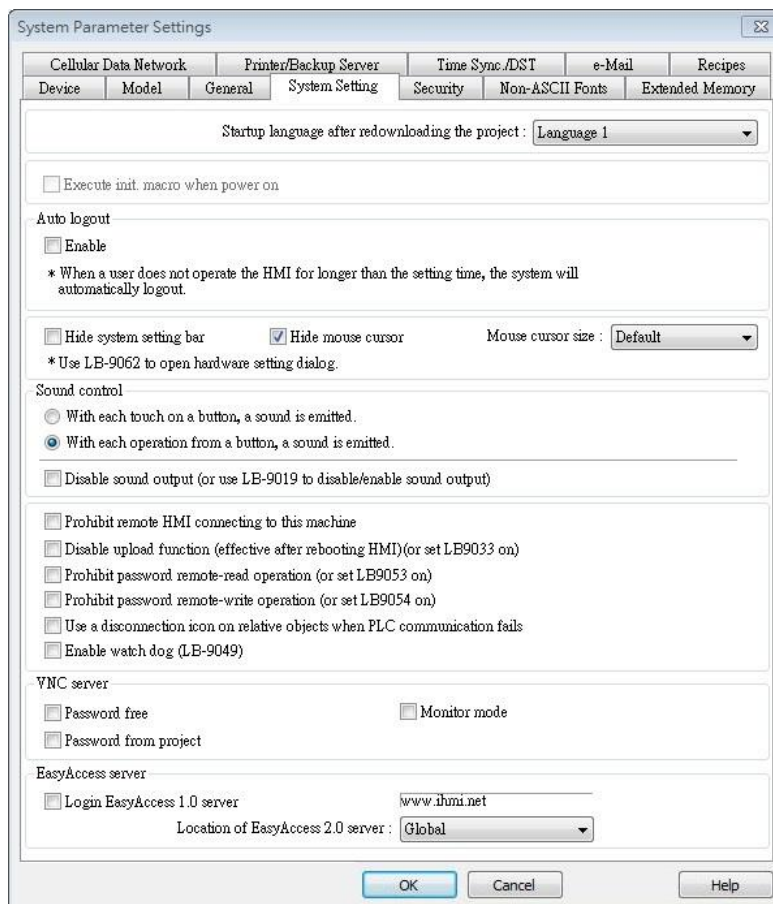



Some features are duplicated from system registers, such as, [Hide system setting bar (LB-9020)], [Hide mouse cursor (LB-9018)], [Disable buzzer (LB-9019)], [Prohibit remote HMI connecting to this machine (LB-9044)], and [Disable upload function (LB-9033)]. Users can also set these features via system tag.

To select a system tag, select [Address] » [System tag] check box when adding a new object and then select the [Device Type].

To browse all the system tags, Select [Library] » [Tag] » [System] from the main menu of

EasyBuilder Pro.

Setting	Description
Startup language after redownloading the project	Set the language to use when HMI starts after the project is re-downloaded.
Execute init. MACRO when power on	Designate the macro to be executed when HMI power on.
Auto logout	If leaving HMI untouched for longer than the set time, the objects protected by security classes will not be able to operate. The user ID and password must be entered again to unlock it.
Hide system setting bar	Hide the system setting bar in the bottom right corner of the HMI screen.
Hide mouse cursor	Hide the mouse cursor in HMI screen.
Mouse cursor size	Set mouse cursor size.
Sound control	<p>With each touch on a button, a sound is emitted: A sound is emitted when touching a button.</p> <p>With Each operation from a button, a sound is emitted: When the [Min. press time] is specified, there may be a time gap between touching the object and the action of the object. This setting can control the timing to emit a sound.</p> <p>Disable sound output: Mute HMI.</p>
Prohibit remote HMI connecting to this machine	Prohibit the connection with a remote HMI. The remote HMI will not be able to control the local HMI.
Disable upload function (effective after rebooting HMI) (or set LB9033 ON)	Disable HMI to upload project, after downloading, HMI must be rebooted to disable uploading project.
Prohibit password remote-read operation (or set LB9053 ON)	Prohibit Remote HMI to read Local HMI.
Prohibit password remote-write operation (or set LB9054 ON)	Prohibit Remote HMI to write Local HMI.

<p>Use a disconnection icon or relative objects when PLC communication fails</p>	<p>If selected, displays a disconnection icon on relevant objects when failing to communicate with PLC. This icon will be shown in the lower right corner of the object.</p>	 
<p>Enable watch dog (LB-9049)</p>	<p>Watchdog automatically reboots the system after the HMI stops functioning for a specified period of time.</p>	
<p>VNC Server</p>	<p>If [Password free] check box is selected, the client can connect with HMI via VNC without entering the password.</p> <p>If [Monitor mode] check box is selected, the HMI connected via VNC can only be monitored but not controlled.</p> <p>If [Password from project] check box is selected, set the password for VNC login.</p>	
<p>LW protection RW protection</p>	<p>If select [Disable LW/RW remote-write] check boxes and set the protect range in [LW/RW range], values within the protected range cannot be adjusted using Remote HMI.</p>	
<p>Easy Access server</p>	<p>Login EasyAccess 1.0 server: Through this technology, users can easily access to any HMI connected to the internet and operate them on PC just like holding touch screen in hand. Easy Access does not transmit updated graphic images directly but only the real time data. This makes transmission really quick and efficient. Please refer to “EasyAccess Manual” for more information.</p> <p>Location of EasyAccess 2.0 server: Current location includes Global and China.</p>	

 **Note**

- cMT-SVR Series does not support VNC Server.

5.6. Security

Parameters in this tab configure the user passwords and security classes. There are two

authentication modes: General Mode and Enhanced Security Mode.

 For more information, see “10 Security”.

5.6.1. General Mode

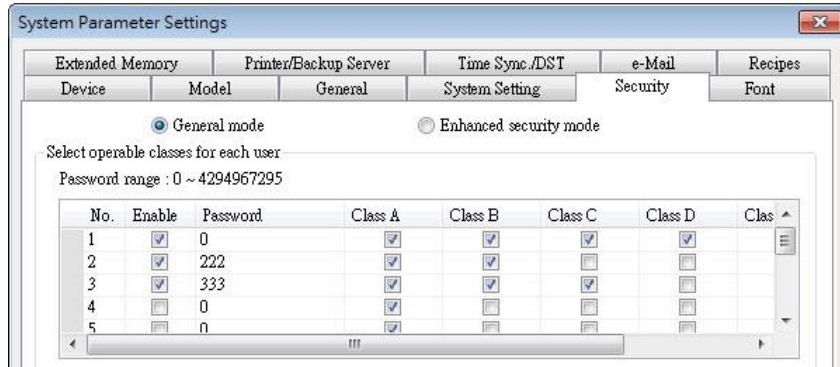

Up to 12 sets of user and password are available. Password should be one non-negative integer. Once the password is entered, the objects that the user can operate are classified.

There are six security classes available: A to F.

If **[None]** is selected for an object, every user can access this object.

For example, when the security class of User No. 3 is set as the preceding figure, User No. 3 could only access objects of classes A, B, C and “none”.

5.6.2. Enhanced Security Mode

At most 11 users can be set here. An [Administrator] user is provided in this mode. An [Administrator] has all privileges and can operate all object classes. User passwords must be alphanumeric and each user can have up to 12 classes: A to L.

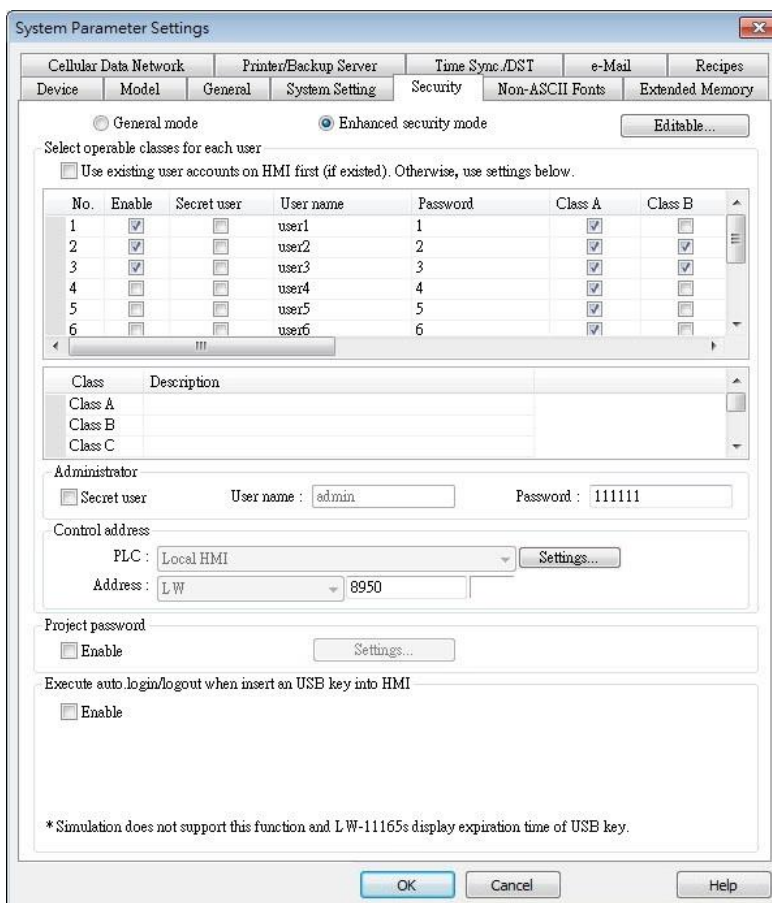

Setting

Description

Editable

Determines whether other users can change the password settings or see passwords.



Enable read-only

Under this mode, the settings can be viewed but not changed.

Mask password

Passwords are masked by asterisks (*).

Select operable classes for each user

When selecting [Use existing user accounts on HMI] check box, the operable objects for each user will be decided by the account settings in HMI.

Administrator

Default administrator account, cannot be deleted, has all privileges, and cannot be changed. Enhanced Security Mode can be used with Option List object. It displays the account names and privileges. If [Secret

	user] is checked, the account names and privileges will be hidden in Option List.
Control address	An address for users to manage the accounts directly on HMI.
Execute auto. Login/logout when insert an USB key into HMI	This feature allows automatic login / logout using an USB security key. The login / logout status will be written into a designated address. Insert the USB disk to HMI to log in, and remove the USB disk to log out. The result codes of login / logout: 0x00: No action, 0x01: Login succeeds, 0x04: Login fails, 0x08: Logout succeeds, 0x10: Logout fails.
Project password	When this password is enabled, other users should enter the password before editing the project file. Select [Enable] and then click [Settings] to set the password.

 **Note**

- cMT Series only supports Enhanced Security Mode, but does not support [Execute auto. Login/Logout when insert an USB key into HMI.]

5.7. Font

5.7.1. eMT, iE, XE, mTV Series

Parameters in [Non-ASCII Fonts] tab determine the non-ASCII fonts. The non-ASCII fonts used are listed here. When using non-ASCII characters or double byte characters (including Simplified or Traditional Chinese, Japanese, or Korean) which are not listed in [Fonts for non-ascii strings] table, EasyBuilder Pro will select a font from the list to substitute for it automatically.

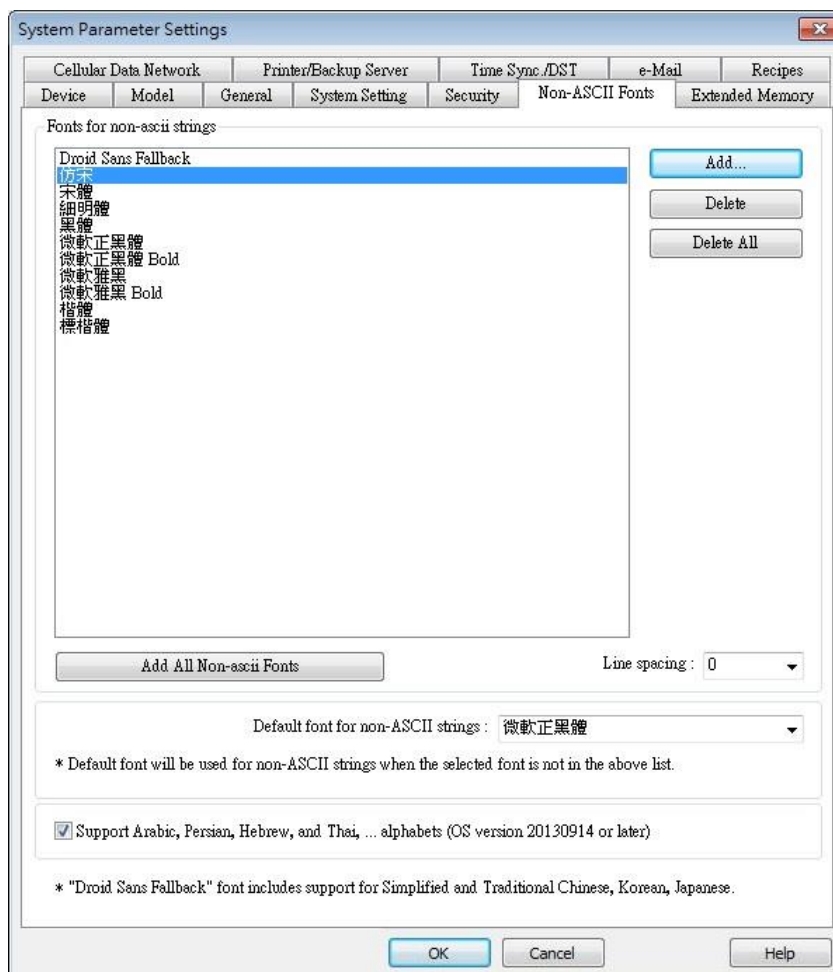

Setting	Description
Add All Non-ascii Fonts	The non-ASCII fonts in Windows can be added to the [Fonts for non-ascii strings] table.
Line spacing	Set the space between the text lines.
Default font for non-ascii strings	EasyBuilder will use the selected font as default font for Non-ASCII strings.
Support Arabic, Persian, Hebrew, and Thai, ... alphabets	Select this check box to correctly display these alphabets.

5.7.2. cMT Series

This tab lists the fonts used in WINDOWS and the mapping fonts in iOS / cMT-iV5 / Android.

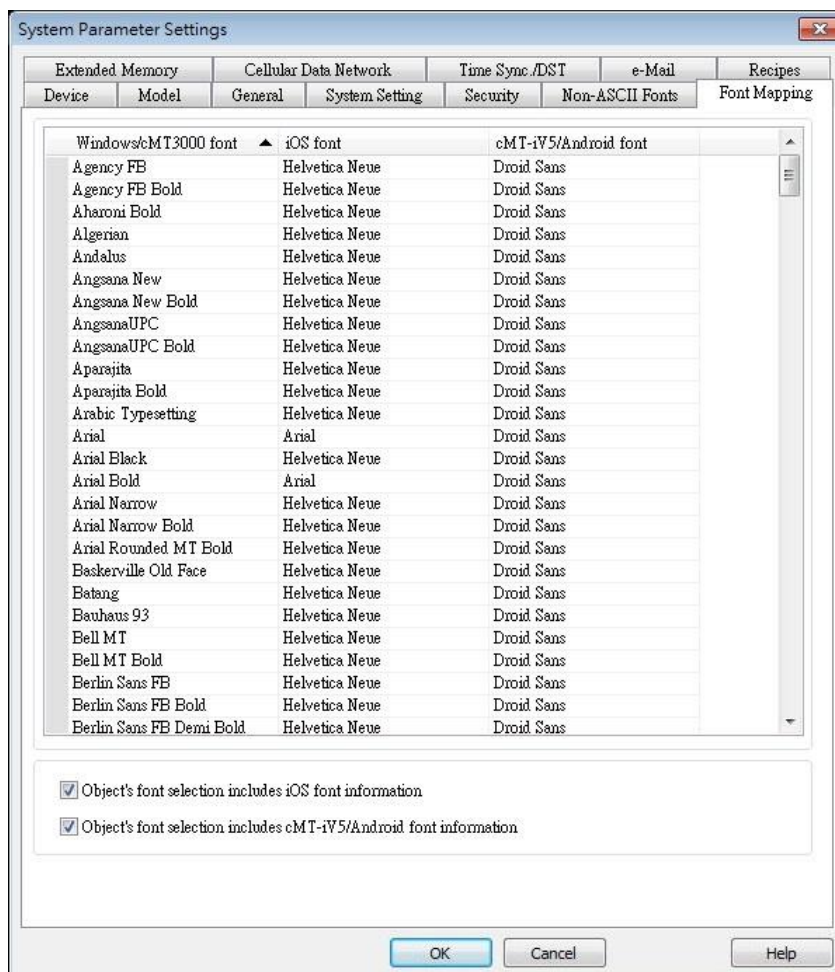

Setting

Description

Object's font selection includes iOS / cMT-iV5/Android font information

When the checkbox is selected, the fonts in iOS / cMT-iV5 / Android that map to the select font in object property settings will be shown.

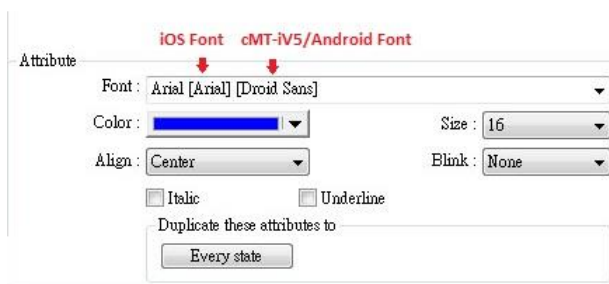

5.8. Extended Memory

Parameters in this tab determine the location of the extended memory.

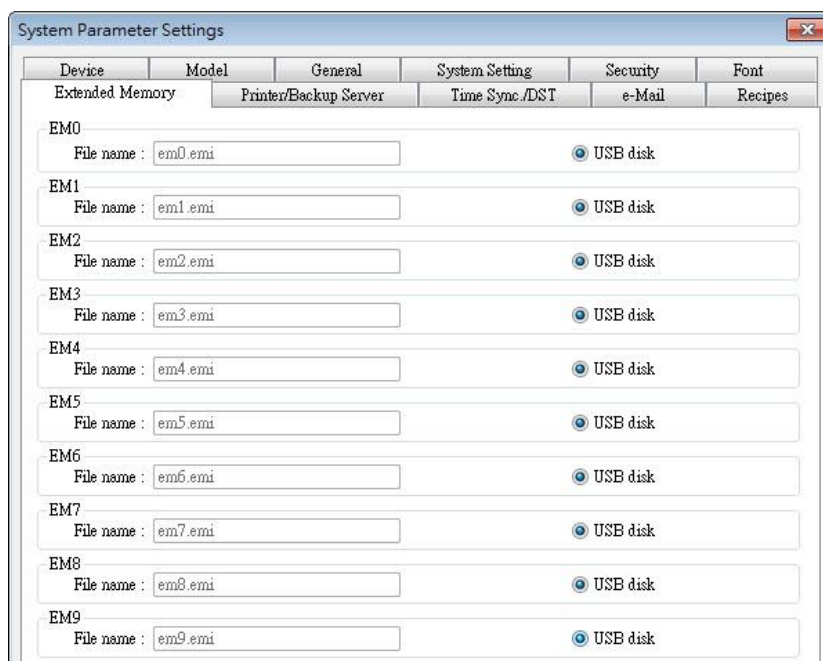

Extended Memory is numbered from EM0 to EM9. It works in a way similar to other device types (i.e. LW or RW address). Users can simply select from [Device type] list while adding a new object. Size of each extended memory is up to 2G word.

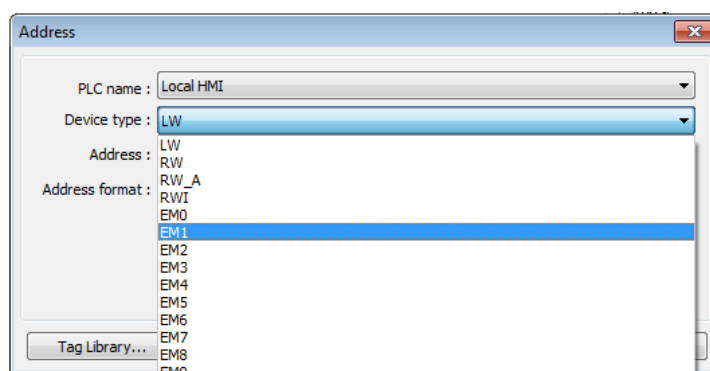

Extended memories are saved as files in [SD card] or [USB disk]. [EM0] to [EM9] are saved as "em0.emi" to "em9.emi" respectively. Users can use RecipeEditor.exe to open these files and edit the data in the extended memory.

Data in extended memory will not be erased when power is cut, which means next time when start up HMI again, data in the extended memory remains the same as before power off. This is similar to recipe data (RW, RW_A). The difference is that users can specify the location to store data. (SD card, USB disk)

When the device of extended memory does not exist and to read data in it, the data content will be "0"; to write data to a device that does not exist, the "PLC no response" message will be shown in HMI.

Users can insert or remove the external device to or from HMI without cutting the HMI power to update or take data in extended memory.

5.9. Printer / Backup Server

Configure remote printer / backup server.

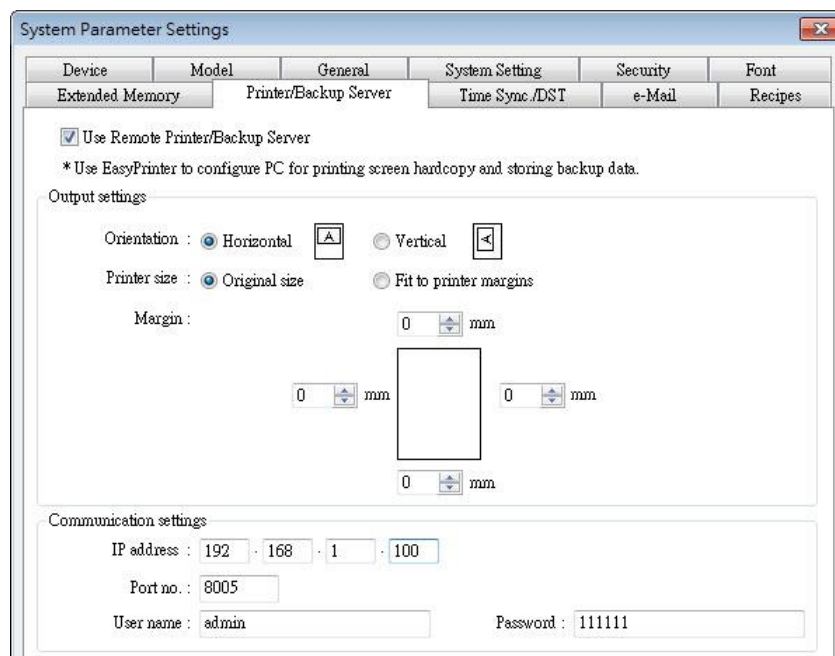

Setting	Description
Output settings	<p>Orientation Set how will words or pictures be printed out, [horizontal] or [vertical].</p> <p>Printer size Set to print out in [Original size] or to [Fit to printer margins].</p> <p>Margin Set the top, bottom, right and left margin width.</p>
Communication settings	<p>IP address Assign the IP address of the printer via network.</p> <p>[Port], [User name], [Password] Specify the data to log in printer. Port can be set from 1 to 65535. Maximum length of user name or password is 12 characters.</p>

 For more information, see “26 EasyPrinter”.

5.10. Time Sync./DST

Synchronize HMI time with NTP server.

Setting	Description
Enable time synchronization via NTP (Network Time Protocol) server	Execute time synchronization when HMI starts Automatically synchronizes HMI time with the designated NTP server when HMI starts.
	HMI time zone Select HMI time zone.
	Server response time Select NTP server time zone.
	Network time server Provides four fields to fill in Network Time Servers for user's device. If the synchronization with server 1 fails, the system will try to synchronize with server 2, and so on. If HMI time cannot synchronize with any of the Network Time Servers, the system register LB-12055 will change to ON status.

	<p>Update interval</p> <p>The frequency of synchronization, the range is from 10 to 86400 seconds.</p>
<p>Automatically set daylight saving time (DST)</p>	<p>Start / End</p> <p>Set the start/end of Daylight Saving Time. The option [Last] may refer to the 5th or 6th week depending on the selected month.</p> <p>Daylight bias</p> <p>Set the time zone's offset during DST.</p>

Note

- When DST ends, and the time falls back, the Trend Display object in Real-time mode will stop refreshing for the overlapping hour(s) when it just going back to standard time. However, historical data will not be affected.
- When DST ends, adjusting HMI time (manually or by network) back to the DST period will not be effective to the system. The system register LB-12355 stays OFF.
- When DST ends, and the time falls back, the system will not start DST for the overlapping hour(s). The system register LB-12355 stays OFF.
- Before DST starts, adjusting HMI time (manually or by network) into the DST period will start DST. The system register LB-12355 will be set ON. The HMI time will be the specified time without adding the offset.
- During DST, adjusting HMI time (manually or by network) to a time that is not within DST period will end DST. The system Register LB-12355 will be set OFF. The HMI time will be the specified time without subtracting the offset.
- This feature **does not yet support the DST in Southern Hemisphere**.

 For more information on system registers relevant to DST, see “22 System Registers”.

5.11. e-Mail

Select [Enable e-Mail function] check box to configure the parameters.

If [Use existing contact settings on HMI] check box is selected, the system will use the contact settings in HMI.

Setting	Description
SMTP Settings	<p>Server: Set SMTP Server.</p> <p>Port: Set communication port.</p> <p>User name: Set e-mail address.</p> <p>Password: Set e-mail password.</p> <p>Confirm Password: Confirm e-mail password.</p> <p>Log on using Secure Password Authentication (SPA): Decide whether SPA is needed when log in e-mail.</p> <p>Use the following type of encrypted connection: Decide whether the encrypted connection (TLS, SSL) is needed when sending e-mail.</p>
Sender Information	<p>Name: Specify the sender name or use HMI name.</p> <p>Mail Address: Setting e-mail address.</p>
Error message	When an error occurs in email delivery, the error message sent from SMTP server can be shown in the designated

	address.
	 For more information on system registers relevant to mail delivery, see “22 System Registers”.
Error notification	Turn OFF LB-12053 or LB-12054 before send an e-Mail When enabled, system registers LB-12053 or LB-12054 will be turned off before sending e-mail, otherwise, when an error occurs in email delivery, the register remains ON.
Test SMTP Settings	Verify SMTP settings in advance by sending a test email to the specified e-mail address.

Click [Open Contact settings] to open the following dialog to edit contacts:

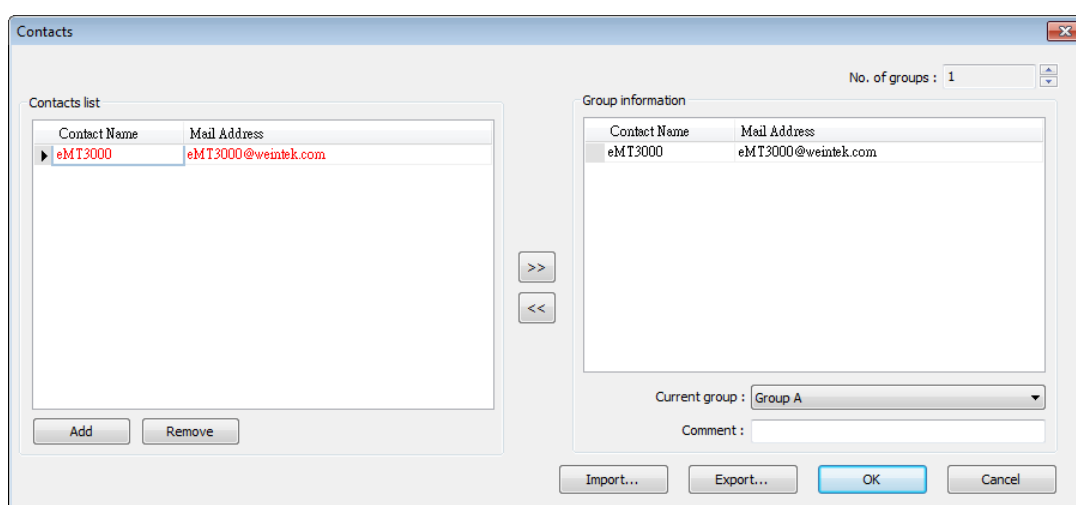

Setting	Description
Contact list	Add or remove contacts from the list.
Group Information	Group up contacts. No. of groups: Set no. of contact groups, according to the number, the groups are named from A to P and up to 16 groups can be set. Current group: Displays the group that includes the contacts above. Comment: Enter a description for the current group.

 For more information on sending Event Log, see “7 Event Log”.

 For more information on e-mail related system registers, see “22.3.40 e-Mail”.

5.12. Recipes

Configure the recipe list for [Recipe Database].

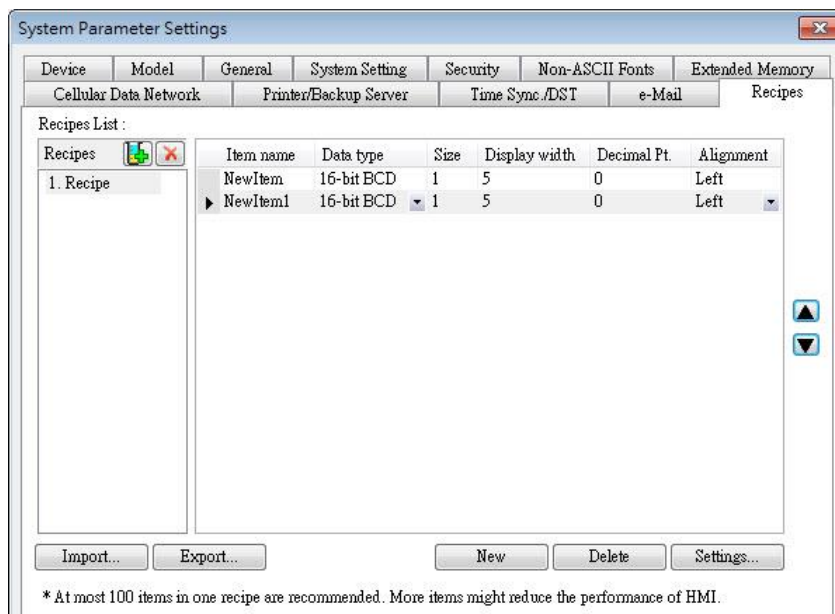

Setting	Description
Recipes List	Add or delete a recipe.
New	Add a new item.
Settings	All the item information can be user-defined and modified, see the following description.
Delete	Delete the selected items.
Import	Import recipe definition.
Export	Export recipe definition. The exported file will not contain recipe records.

Click [Settings]:

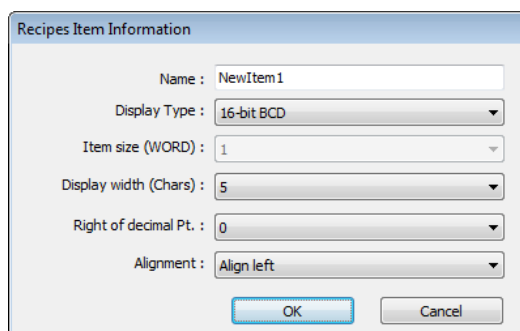

Setting	Description
Name	Enter recipe item name.
Display Type	Setting item data type.
Item size (WORD)	Setting the size of the item.

Display with (Chars)	Setting the number of characters of the item to be displayed.
Right of decimal pt.	Setting the decimal place when displaying data.
Alignment	Setting the alignment when displaying data. [Align left], [Align center], and [Align right] can be selected.

 **Note**

- The maximum number of Recipe Database acceptable in a project file is 100 Recipe Databases. A Recipe Database can contain 1000 items.
- The maximum data length acceptable in a Recipe Database is 1024 words. Exceeding the limit can lead to compilation failure.
- The name of Recipe Database and recipe items should be alphanumeric.

 For more information, see “24 Recipe Editor”.

5.13. Cellular Data Network

This tab is for setting cellular data. Cellular data network settings may differ from one model to another.

cMT Series

Attaching a 3G/4G USB dongle to the USB port enables the cMT-SVR to connect to 3G/4G networks.

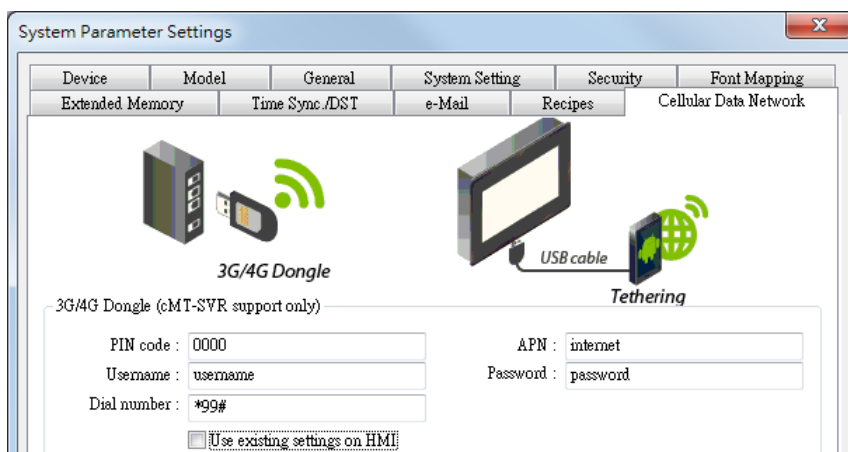

Setting	Description
Use existing contact settings on HMI	If this check box is selected, the cellular data currently in HMI will be used. When no specific settings are required, generally, [PIN code] is “0000”, [APN] is “internet”, and [Username], [Password], [Dial number] are optional.

The relevant registers:

- LW-11297: (16 words) : PIN code of SIM card (cellular network)
- LW-11313: (16 words) : Access Point Name (cellular network)
- LW-11329: (16 words) : username (cellular network)
- LW-11345: (16 words) : password (cellular network)
- LW-11361: (16 words) : dial number (cellular network)
- LW-11377: (16bit) : stop (set 0)/start (set 1) connection (cellular network)
- LW-11378: (16bit) : last error code (0:success, 1:incorrect PIN code, 2:no SIM, 3:no device, 4:puk locked, 5:other) (cellular network)
- LW-11379: (16bit) : connection status (0:no device, 1:disconnect, 2:connecting, 3:connected) (cellular network)

eMT, iE, XE, mTV Series

By connecting an Android mobile phone with HMI using a micro USB cable, or any USB data cable that is compatible with the phone, the internet connection of the phone can be shared with HMI. On the Android mobile phone please enable USB Tethering.



When successfully connected, the following registers can be used to monitor and control the connection status.

- LW-11380: (16bit) : stop (set 0)/start (set 1) connection (USB tethering)
- LW-11381: (16bit) : connection status (0:no device, 1:disconnect, 2:connected, 3:fail, 4:OS not support, 5:HMI not support) (USB tethering)

6. Window Operations

This chapter describes different types of windows and how to create, set and delete a window.

6.1.	Overview.....	6-2
6.2.	Window Types	6-2
6.3.	Create, Set, and Delete a Window.....	6-4
6.4.	Window Transparency	6-7

6.1. Overview

A window is a basic element in a project. With a window, all kinds of information like objects, pictures, and texts can be displayed on HMI screen. In total, 1997 windows numbered from 3 ~ 1999 in EasyBuilder Pro can be built and edited.

6.2. Window Types

There are 4 types of windows, each with different functions and usages:

- Base Window
- Fast Selection Window
- Common Window
- System Message Window

6.2.1. Base Window

The most frequently used window, except for main screen, it can also be:

- A background of other windows.
- A keyboard window.
- A pop-up window of Function Key object.
- A pop-up window of Direct Window and Indirect Window objects.
- A screen saver.



Note

- Base Window should be in same size as the HMI screen. Therefore, the resolution of the base window should be set to the resolution of HMI.

6.2.2. Fast Selection Window

Window no. 3 is the default Fast Selection Window. This window can co-exist with base window. Generally, it is used to place the frequently-used buttons on the lower-left side or the lower-right side on the screen. Please create window no. 3 first, and set the relevant properties in [System Parameter Settings] » [General] tab. Apart from showing or hiding fast selection window with the button on the screen, there are system registers to do so:

[LB-9013] Fast Selection window control [hide(ON)/show(OFF)]

[LB-9014] Fast Selection button control [hide(ON)/show(OFF)]

[LB-9015] Fast Selection window/button control [hide(ON)/show(OFF)]



Note

- cMT Series does not support Fast Selection Window.

6.2.3. Common Window

Window no. 4 is the default Common Window. Objects in this window will be displayed in other base windows, not including pop-up windows. Therefore, the common objects in different windows are often placed in common window.

When operating HMI, select [Function Key] » [Change common window] to change the source of common window.

In menu [Option] » [Preferences] select whether or not to [Display Common Window objects on Base Windows] when editing a project. This can avoid overlapping objects in base window with objects in common window.

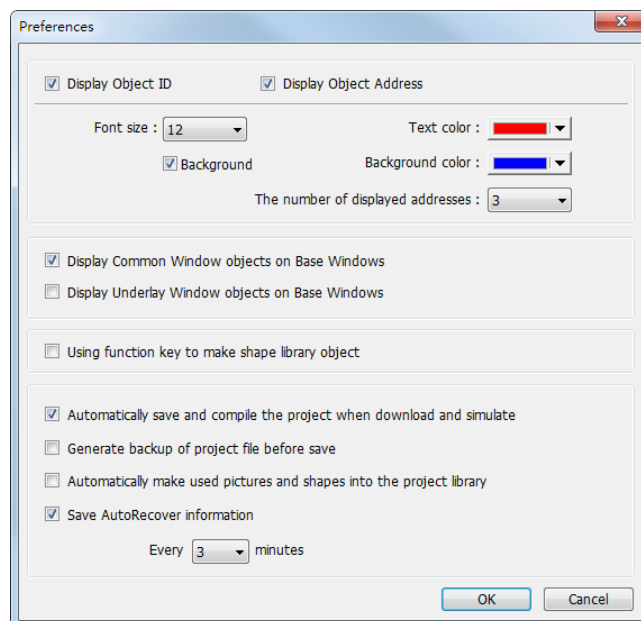

6.2.4. System Message Window

Windows No. 5, 6, 7, 8 are the default System Message Windows:

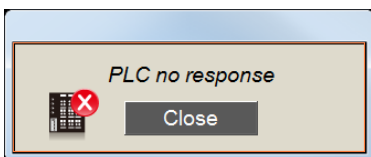

Window No. 5: PLC Response

When the communication between PLC and HMI is disconnected, this message window will pop up automatically right on the base window currently opened. This window can be disabled by system registers.

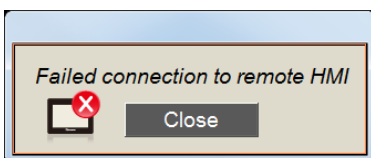

Window No. 6: HMI Connection

When failing to connect HMI with a remote HMI, this message window will pop up automatically.

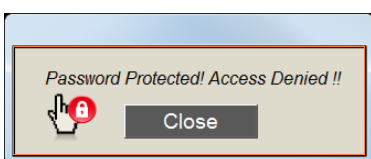

Window No. 7: Password Restriction

When attempting to control an object without authorization, this window may pop up as a warning depending on the settings of the object.

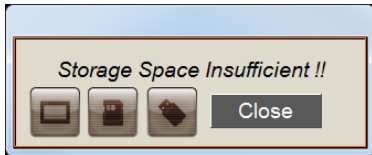

Window No.8: Storage Space Insufficient

When HMI flash memory, USB disk or SD card run out of storage space, this message window will pop up automatically. (When the memory space is under 4 MB)

The following system registers can be used to check the free memory space in HMI, USB disk, or SD card:

[LW-9072] HMI current free space (K bytes)

[LW-9074] SD current free space (K bytes)

[LW-9076] USB disk current free space (K bytes)

To check if there is sufficient storage in the devices, the following system registers can be used. These addresses will set ON when the space is under 4 MB.

[LB-9035] HMI free space insufficiency alarm (when ON)

[LB-9036] SD card free space insufficiency alarm (when ON)

[LB-9037] USB disk free space insufficiency alarm (when ON)

 For more information, see “22 System Registers”.

The text shown in windows no. 5 ~ 8 can be edited for easier reference.

Note

- A screen can display up to 16 pop-up windows simultaneous including System Message Window, Direct Window and Indirect Window.
- The system does not allow opening the same window with two Direct (or Indirect) Windows in one base window.
- Windows no. 3 to 9 are used by the system only, and windows no. 10 to 1999 can be edited based on actual usage.
- For cMT Series, only 1 pop-up window can be displayed at a time.

6.3. Create, Set, and Delete a Window

Check the existing windows in [View] » [Window Tree].

[Object list] displays window numbers and window names. Opened windows are marked with (*) sign. Press the (+) sign to see the object ID, address and description in this window.

[Window preview] displays the thumbnails of windows.

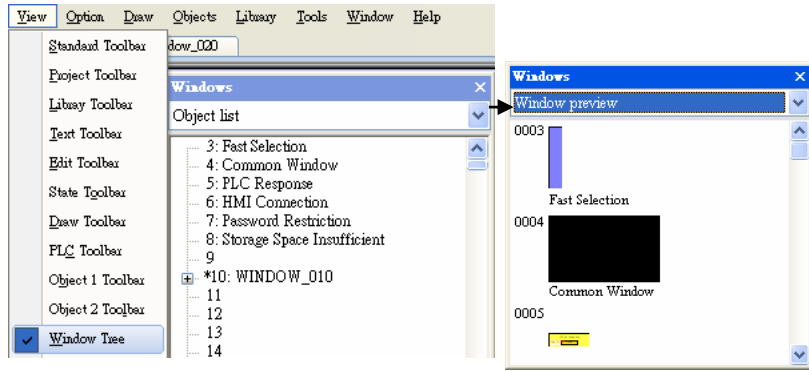

6.3.1. Creating and Setting a Window

In window tree right click on a window number then select [New].

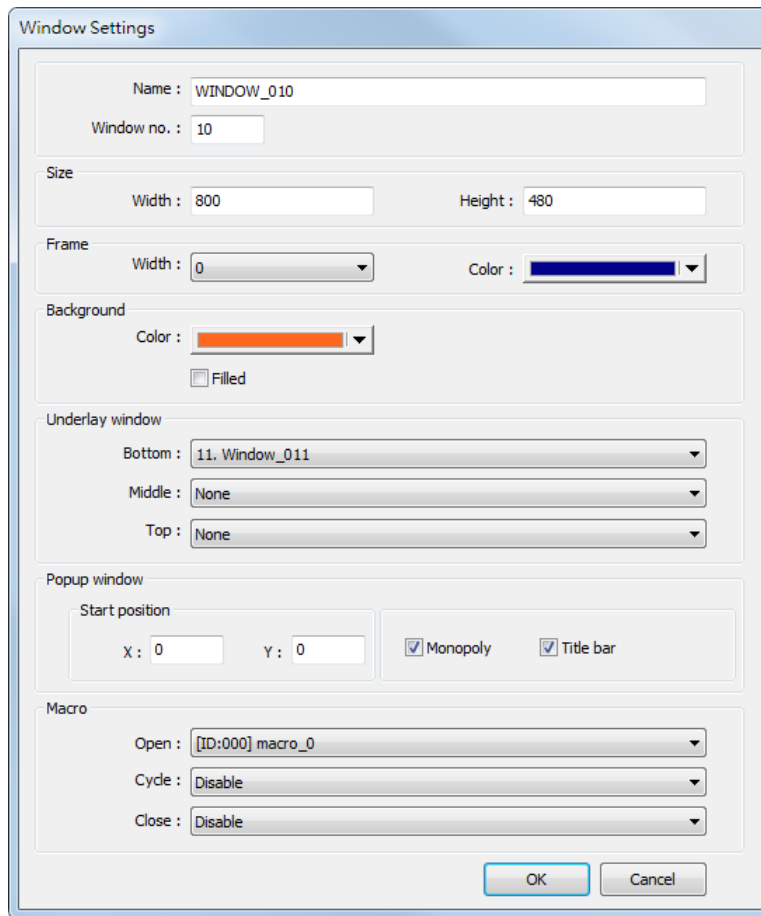

Setting	Description
Name	The name appears on the title bar and also in window tree.
Window no.	Can be 3 to 1999.
Size	Set the window size in accordance with the HMI resolution.
Underlay window	Underlay Window can be seen as an extra Common Window. When designing the project, some commonly used objects are used in some windows but not all. These objects can be placed in underlay window.

	Each base window can set three underlay windows as background, from [Bottom] to [Top]. The objects in underlay windows are displayed in this order in base window.
Pop-up window	Base window can also be used as a pop-up window. Use [X] and [Y] to set the coordinates indicating where in the screen will this base window pop up. The origin of the coordinates is the upper-left corner of the window.
Monopoly	If the option is selected, when the base window pops up, no operations of other pop-up windows and background windows are allowed until the monopoly window is closed. If a base window is used as a keyboard window, "Monopoly" is automatically enabled.
Title bar	If the option is selected, a title bar appears on a system message window. This feature is only available for system message windows no. 5 to no. 8.
Macro	Select the macro to be executed when the window opens or closes, or the macro to be executed periodically (each 500 ms). Please build the macro in advance.

Note

- The objects in underlay window cannot be edited from the base window that displays them. To edit those objects, please open the underlay window where they are located.
- When the window number of the underlay window used by the base window is identical to the pop-up window, the pop-up window is disabled.
- When base window and pop-up window use the same underlay window, the objects in the underlay window cannot be displayed in pop-up window.

Or, from the main menu click [Window] » [Open Window] and then click [New] and select the type of the window and click [OK].

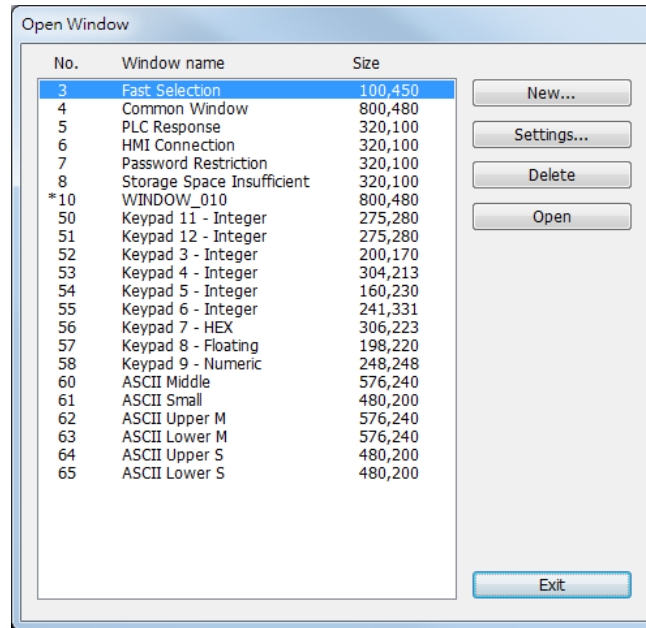

Ways to call up [Window Settings] dialog:

- Right click on the window number in the window tree and select [Settings].
- In [Window] » [Open Window] select the window then click [Settings].
- In the window, right click when no object is selected, and select [Attribute].

6.3.2. Open, Close, and Delete a Window

The ways to open an existing window:

- Double click on the window number in the window tree.
- In the window tree, select the window, right click, and then select [Open].
- In [Window] » [Open Window] select the window then click [Open].

The ways to close or delete an existing window:

- In the window tree, select the window; right click, then select [Close] or [Delete].
- In [Window] » [Open Window] select the window then click [Delete].
- To delete a window, please close it first.

6.4. Window Transparency

The cMT Series models support setting window transparency. This setting is applicable for popup windows, Direct / Indirect Windows, and keyboard windows. The settings dialog box and the effect are shown in the following screenshots. Greater transparency can make the object on the base window more visible when it is covered by the popup window.

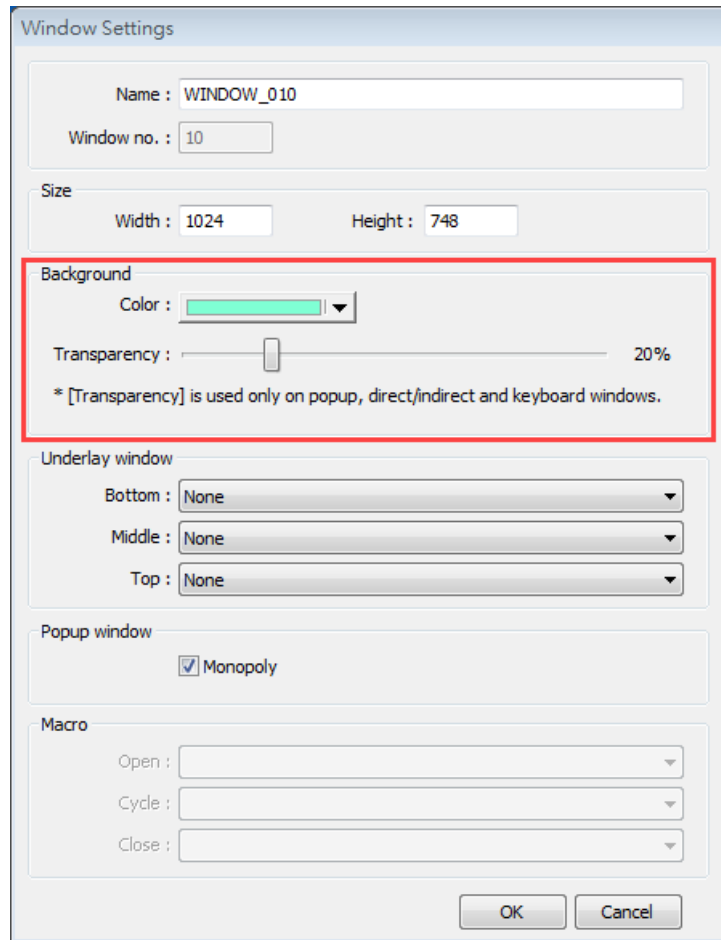

Example

Setting transparency to 40%:

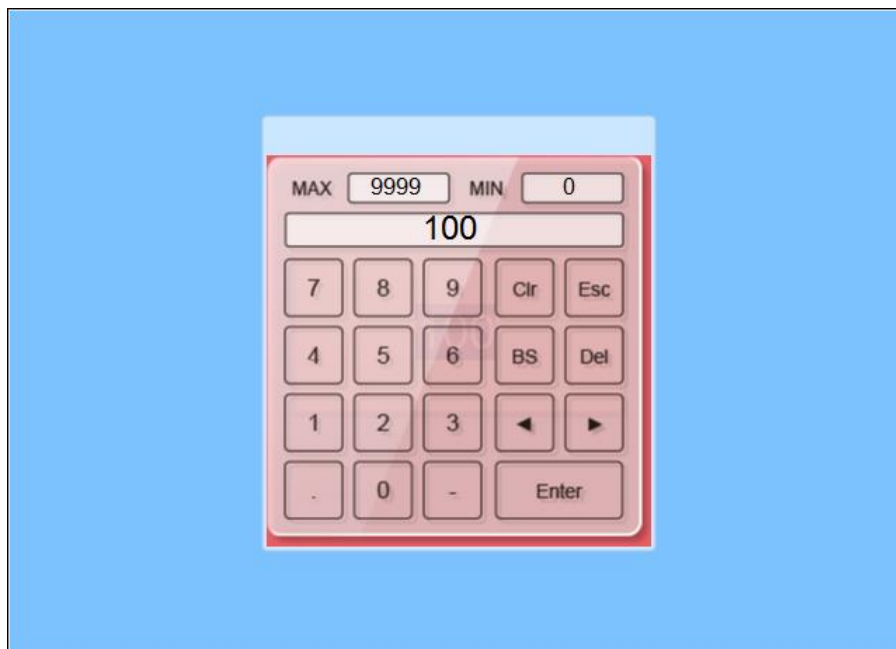

Setting transparency to 90%:

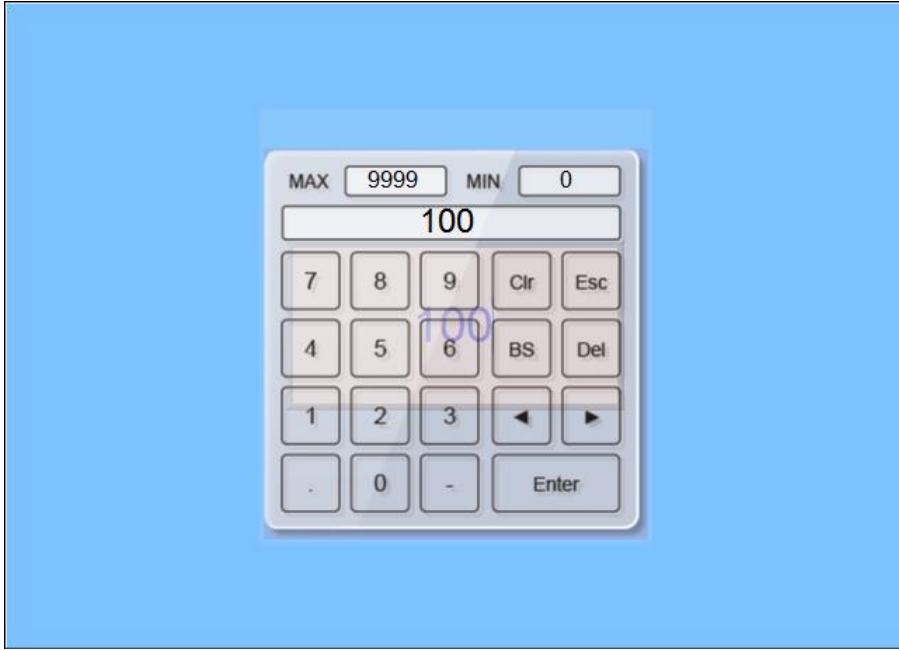

7. Event Log

This chapter explains how to set and use Event Log.

7.1. Overview.....	7-2
7.2. Event Log Management.....	7-2
7.3. Creating a New Event Log.....	7-8



7.1. Overview

The following are the basic steps to use Event Log:

1. Define event content and trigger condition.
2. Trigger event according to the condition.
3. Save the event log to the specified device.
4. View the process of event by using the relevant objects.

This chapter will explain how to set and use Event Log.

7.2. Event Log Management

Firstly, define the event content then use Alarm Bar , Alarm Display , Event Display  objects to view the process of the whole event from triggering → waiting to be processed → return to normal.

7.2.1. eMT, iE, XE, mTV Series

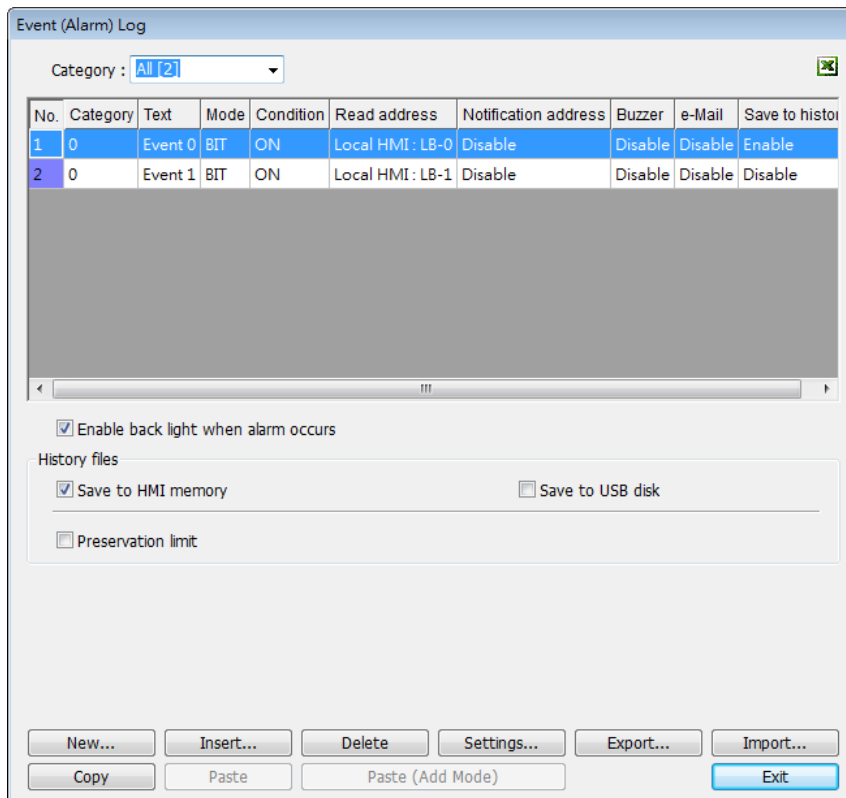

Setting

Description

Category

Classifies events by dividing them into 0 ~ 255 categories. Select one category to add or view event log. In the bracket “[]”, it shows the number of events are in this category.

History files	<p>Saves event log files to the specified location. Once an event occurs, the HMI immediately saves the history file. When executing On-line or Off-line Simulation on PC, the files will be saved in the HMI_memory / SD_card / USB folder under the installation directory.</p> <p>Preservation limit</p> <p>This setting determines the maximum number of Event Log files to be preserved in HMI memory. This does not include the file generated today. That is, if [Days of preservation] is set to 2; the two latest files excluding the file generated today will be kept. The files that are not within the range will be deleted automatically for saving the storage space.</p>
Save to history	<p>When a location to save event log files is specified in [History files] group box, each event can be respectively defined whether to be saved to history. The events will still be displayed in Event Display object Real-time mode, but not in History mode.</p>
Print	<p>In [System Parameter Settings] » [Model], select a printer and set the printing format.</p>
Paste	<p>Overwrites the selected item with the new items. A message window will pop up to confirm this operation.</p>
Paste (Add Mode)	<p>Appends as a new entry.</p>

7.2.2. cMT Series

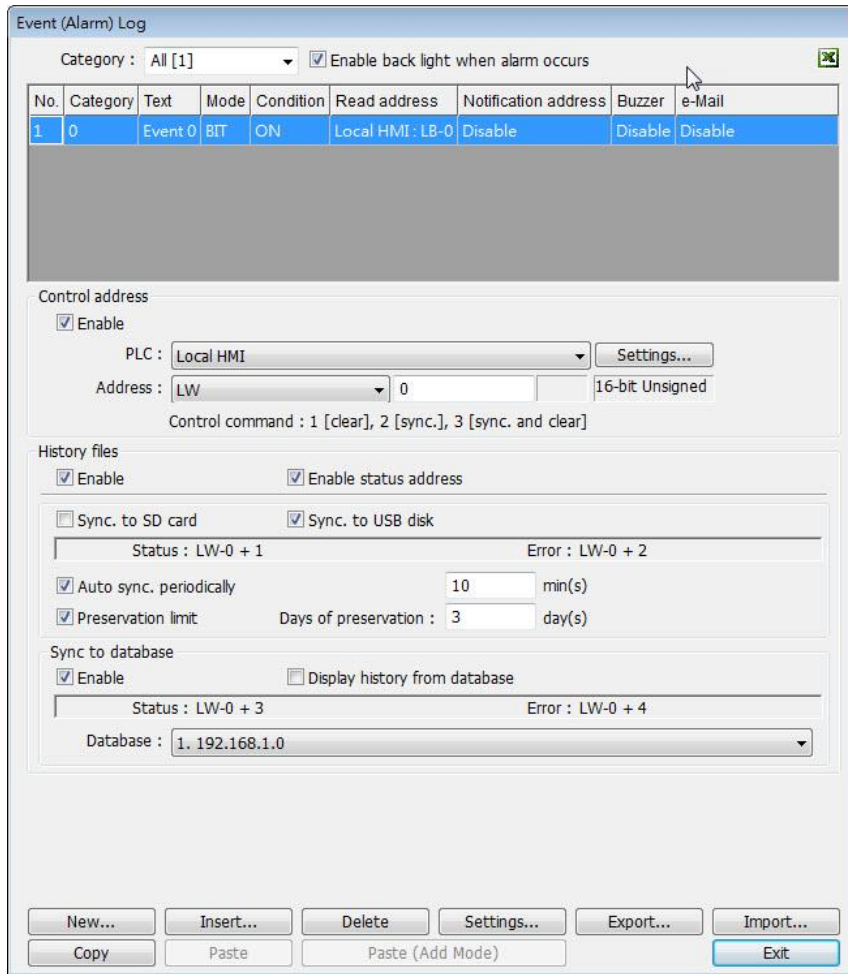

Setting	Description												
Category	Classifies events by dividing them into 0 ~ 255 categories. Select one category to add or view event log. In the bracket “[]”, it shows the number of events are in this category.												
Control address	If select [Enable] check boxes under both [Control address] and [History files], entering a specific value in the control address sends the corresponding command.												
	<table border="1"> <thead> <tr> <th>Value</th> <th>Command</th> </tr> </thead> <tbody> <tr> <td>1</td> <td>Clear the event log on cMT-SVR</td> </tr> <tr> <td>2</td> <td>Synchronize event log to the external device</td> </tr> <tr> <td>3</td> <td>Synchronize event log to the external device and then clear the event log on cMT-SVR</td> </tr> <tr> <td>4</td> <td>Use the history data stored in USB disk / SD card after changing HMI</td> </tr> <tr> <td>11</td> <td>Update event log message contents by reading a new String Table</td> </tr> </tbody> </table>	Value	Command	1	Clear the event log on cMT-SVR	2	Synchronize event log to the external device	3	Synchronize event log to the external device and then clear the event log on cMT-SVR	4	Use the history data stored in USB disk / SD card after changing HMI	11	Update event log message contents by reading a new String Table
Value	Command												
1	Clear the event log on cMT-SVR												
2	Synchronize event log to the external device												
3	Synchronize event log to the external device and then clear the event log on cMT-SVR												
4	Use the history data stored in USB disk / SD card after changing HMI												
11	Update event log message contents by reading a new String Table												

If none of these values is entered, the system will synchronize data in the same rules as [History files] setting explained below.

Status**Error**

(cMT Series)

When LW-n is used as the control address, the four consecutive addresses following LW-n (LW-n+1~LW-n+4) will show status and error, please see the prompt in the settings dialog box.

Value	Status address: LW-n+1 and LW-n+3
0	Disconnected from external device or database
1	Connecting with external device or database
2	Connected with external device or database
3	Storing records into the archive. When this is done, the value returns to 2.
Value	Error address: LW-n+2 and LW-n+4
0	None
1	Unknown error
2	Failed to connect with external device or database
3	Access denied
4	Wrong database name
5	Inconsistent data format
6	Failed to open table
7	Failed to create table
8	Failed to write table

History files

Saves the synchronized data to SD, USB disk, or database. The rules of synchronizing the data saved in the external device are:

- When the number of events is under 10000, the events

	<p>will be temporarily saved in cMT-SVR.</p> <ul style="list-style-type: none"> ■ When the number of events reaches 10000, the system will automatically save the data to the external device and deletes the earliest 1000 events in cMT-SVR. ■ If the external device already contains some events, the new data is appended without overwriting the original data each time in synchronization. ■ When the external device is removed from cMT-SVR, or cMT-SVR is disconnected from database server, if the connection is recovered before the number of events exceeds 9000, the events occur during disconnection will be saved to cMT-SVR. If the number of events exceeds 9000 during disconnection, the earlier data will be deleted, and cannot be synchronized by recovering connection.
Auto sync. periodically	<p>Data will be automatically synchronized to the designated external device in the specified time interval, regardless of the rules explained above.</p> <p>Unit: Minute(s) Range: 1~1440</p>
Preservation limit	<p>This setting determines the maximum number of Event Log files to be preserved in HMI memory. This does not include the file generated today. That is, if [Days of preservation] is set to 2; the two latest files excluding the file generated today will be kept. The files that are not within the range will be deleted automatically. The system checks the time of the files and deletes earlier files only during synchronization.</p>
Display history from database	<p>With this option selected, Event Log displays the history data read from database.</p>
Paste	<p>Overwrite the selected items with the clipboard contents. A message window will pop up to confirm this operation.</p>
Paste (Add Mode)	<p>Append the clipboard contents to the end of the list.</p>

Note

- Before removing SD card / USB disk, or disconnecting from database server, please synchronize event log data by using control address.

7.2.3. Excel Editing

Click on the Excel icon in Event Log setting dialog box to open the Excel template for a reference of editing. This template is under the installation directory, the file name is EventLogExample.xls. This template includes the ready-made dropdown lists and validation mechanism.

	A	B	C	D	E	F	G	H	I	J	K
1	Category	Priority level	Address type	PLC name	Device type	System tag	User-defined tag	Address	Index	Data Format	Enable
2	0	Middle	Word	Local HMI	LW	False	False	100	null	32-bit Signed	True
3	1	Low	Bit	Local HMI	LB-9009	True	False	9009	IDX 5	16-bit BCD	False
4										16-bit BCD	
5										32-bit BCD	
6										16-bit Unsigned	
7										16-bit Signed	
										32-bit Unsigned	
										32-bit Signed	
										32-bit Float	

Note

- [System tag] and [User-defined tag] cannot be set to true simultaneously, otherwise, the system will view the User-defined tag to be a System tag, and [User-defined tag] to be false. If setting [Device type] to [User-defined tag], please set [System tag] to false.
- When setting [User-defined tag] to true, if the system compares the [Device type] with the user-defined tag in the system, and no suitable tag is found, the system will set the [User-defined tag] in event log to false
- [Color] format is R:G:B, each should be an integer form 0 to 255.
- Before importing Label Library / Sound Library, please make sure the library names exist in the system.

7.2.4. Quick View of Errors

When compiling the project, the errors in Event Log will be displayed in the Compile window. To open Event Log and view the errors, double click on the item in the Compile window.

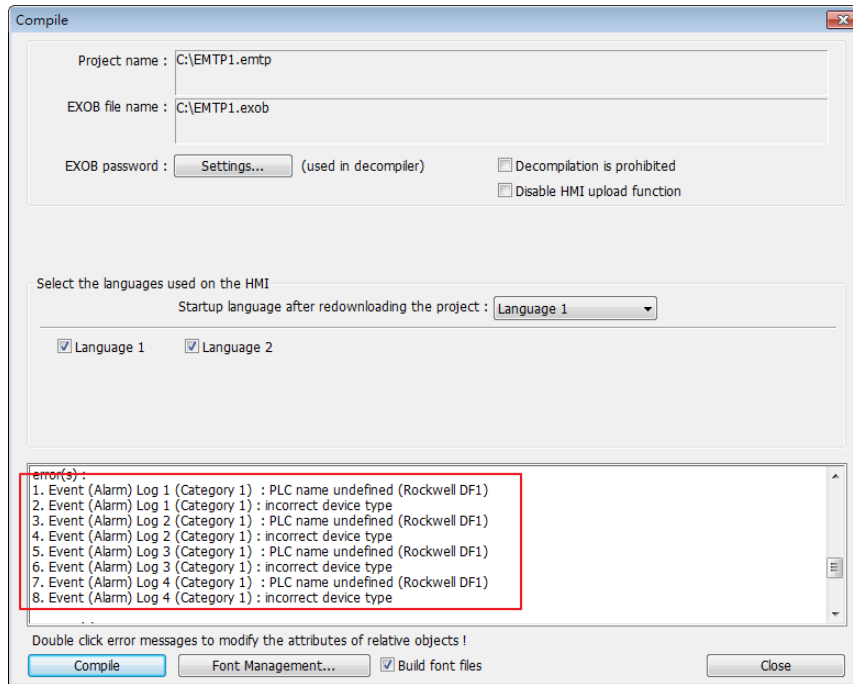

7.3. Creating a New Event Log

General Tab

Click [New] in the [Event (Alarm) Log] dialog box.

Setting	Description
Category	Select event category, the range is from 0 to 255.
Priority level	When the number of events equals to the max number of the system (default 1000), the lower priority events will be deleted and new events will be added in.
Save to history	In Event Log main settings, if [Save to HMI memory] check box under [History files] group box is selected, selecting [Save to history] here determines whether each separate event should be saved as historical file.
Push notification (cMT Series)	With this check box selected, each time when an event occurs, user's iOS/Android device can run EasyAccess 2.0 application to receive push notifications.
Delay time for event monitoring when HMI resets	This feature is used to set the delay time of Event Log after HMI reboot, in order to avoid false alarm that occurs upon HMI reboot due to uninitialized values. This feature is often used with [Dynamic condition value]. The delay time only occurs once upon HMI reboot.
Read address	The system reads data from this address to check if the event matches the trigger condition.

Notification When enabled, the system will set the specified address ON or OFF when the event is triggered.

Follow

The notification bit will reset to its original state once the alarm condition returns to normal. For example, when the alarm is triggered, the state of the notification bit turns ON. When the alarm condition returns to normal, and [Follow] check box is selected, the state of the notification bit turns OFF.

Condition When [Bit] is selected, Event Log will detect the state of a Bit address.

When [Word] is selected, Event Log will detect the value of a Word address to check if it is greater than, less than, or equals to a specified value. See Example 1 and Example 2.

Dynamic condition value

Allows online change of the comparison value for trigger condition when the condition is a Word address type. If [Read/Condition use different addresses] is not selected, the source of condition value will be the next consecutive address from [Read address].

Read/Condition use different addresses

Allows selecting the Word address type to be the source of condition value.

Example 1

The setting above indicates:

When [Read address] value is greater than or equals to 29 (= 30 - 1)

Or less than or equals to 31 (= 30 + 1), the event will be triggered. The trigger condition:

$$29 \leq [\text{Read address}] \text{ value} \leq 31$$

After the event is triggered, when [Read address] value is greater than 32 (= 30 + 2) or less than 28 (= 30 - 2) the system will return to normal condition:

$$[\text{Read address}] \text{ value} < 28 \text{ or } [\text{Read address}] \text{ value} > 32$$

Example 2

The setting above indicates:

When [Read address] value is less than 29 (= 30 - 1)

or greater than 31 (= 30 + 1), the event will be triggered. The trigger condition:

[Read address] value < 29 or [Read address] value > 31

After the event is triggered, when [Read address] value is greater than or equals to 28 (= 30 - 2)

or less than or equals to 32 (= 30 + 2) the system will return to normal condition:

$28 \leq [\text{Read address}] \text{ value} \leq 32$

Message Tab

Setting	Description
Content	The text content displayed in [Alarm Bar], [Alarm Display], and [Event Display] objects. Use the formats in the following two examples of WATCH addresses to use register data in content. See Example 3, and Example 4. The content in Label Tag Library and String Table can be used in the Event Log message.
Font / Color / Background color	The font / color / background color can be set respectively for each event. The font and color settings determine how [Alarm Bar] shows the text, while The font, color, and background color settings determine how [Alarm Display]

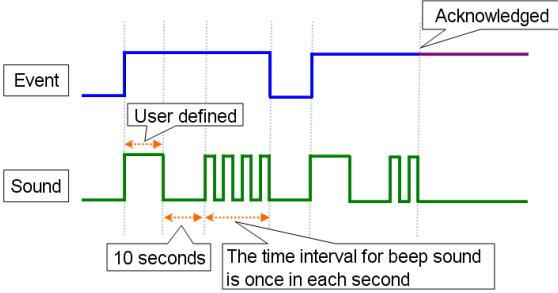
	and [Event Display] show the text. These settings are not available in the [Event Display] under History mode.
Write value for Event/Alarm Display object	When an event in [Event Display] or [Alarm Display] is acknowledged, the value is written to the assigned [Write address].
Sound	<p>If enabled, the selected sound will be played when an event is triggered. Continuous beep can also be enabled, which only stops when the event is acknowledged or recovered.</p> <p>For continuous beep, a delay time can be set between triggering the alarm and the start of beeping.</p> 
Address of WATCH 1 ~ 8	Click [Syntax] to edit and display the value in watch address when the event is triggered. Up to 8 watch addresses can be set.

Example 3

The data of the LW register can be used in the content displayed when an event is triggered:

Format: **%#d** (% -> initial sign, # -> address, d -> end sign)

When an event is triggered, if the value in LW-20 is 13:

Setting: "High Temperature = %20d" → Display: "High Temperature = 13"

Example 4

The data in the specified address when the event is triggered can be included in the content displayed. The address should be set to the [Read address] of Event Log, take MODBUS RTU 4x address as an example:

Format: **\$#d** (\$ -> initial sign, # -> address, d -> end sign)

When an event is triggered, if the value in MODBUS 4x-15 is 42:

Setting: "High Temperature = \$15d" → Display: "High Temperature = 42"

e-Mail Tab

Please enable this function in [System Parameter Settings] » [e-Mail] first.

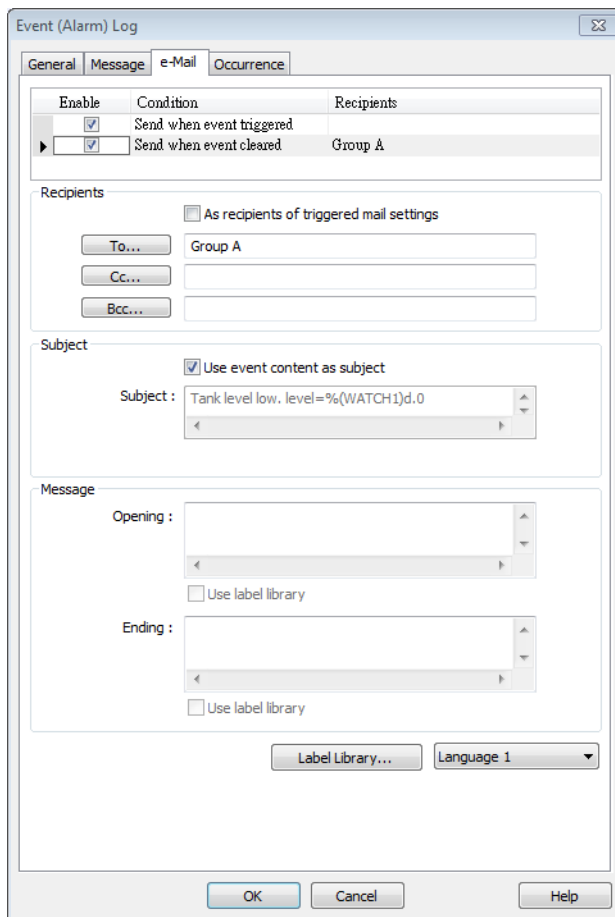

Setting	Description
Recipients	Select the [To], [Cc], and [Bcc] recipients.
Subject	Enter the subject of the e-mail.
Message	Enter the [Opening] and [Ending] content of an E-mail.
Attach	If the [Contains a screenshot of window] check box is selected, the screenshot of the selected window will be attached.

Statistics

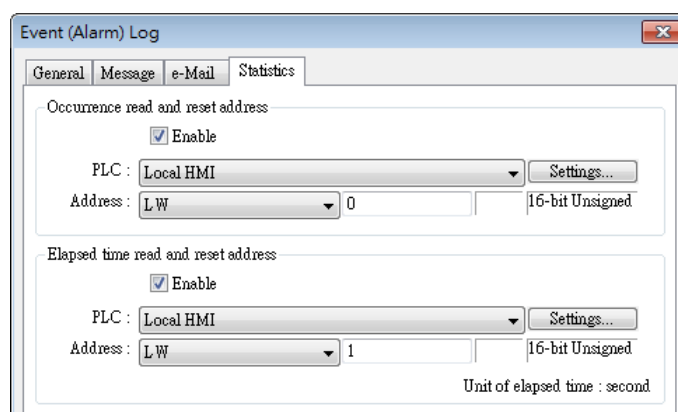

Setting	Description
Occurrence read and reset address	If enabled, the number of events occurred after HMI startup will be written to the designated word address. The word address can be read / written.
Elapsed time read and reset address	The elapsed time (in seconds) of the event will be written to the designated word address. The word address can be read / written.

8. Data Sampling

This chapter explains how to set and use Data Sampling.

8.1.	Overview.....	8-2
8.2.	Data Sampling Management	8-2
8.3.	Creating a New Data Sampling	8-2
8.4.	Synchronizing cMT Viewer data and Saving to External Device.....	8-11
8.5.	Checking History Data of a Specific Date on cMT Viewer.....	8-12

8.1. Overview

After defining how the data is sampled, by sampling time, address, or data length, the sampled data can be saved to the designated location, such as HMI memory, SD card, or USB disk. Trend Display and History Data Display objects can be used to display sampling records.

8.2. Data Sampling Management

Create a new Data Sampling object first by the following steps:

1. From the menu select [Objects] and click [Data Sampling].
2. Click [New] to finish relevant settings.

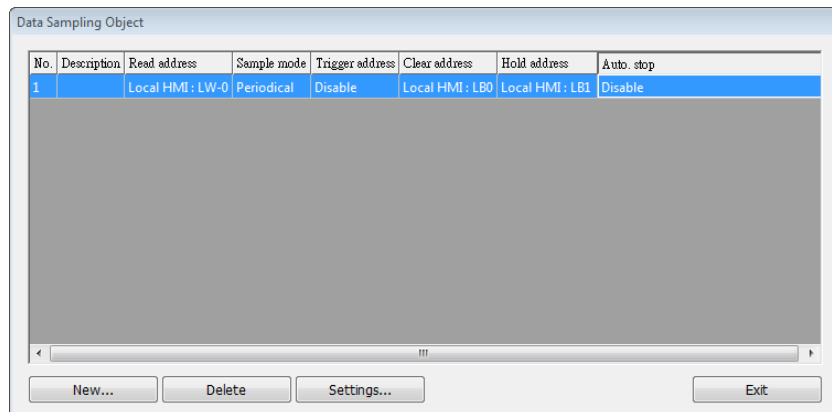

8.3. Creating a New Data Sampling

The following introduces how to set a new Data Sampling.

eMT, iE, XE, mTV Series

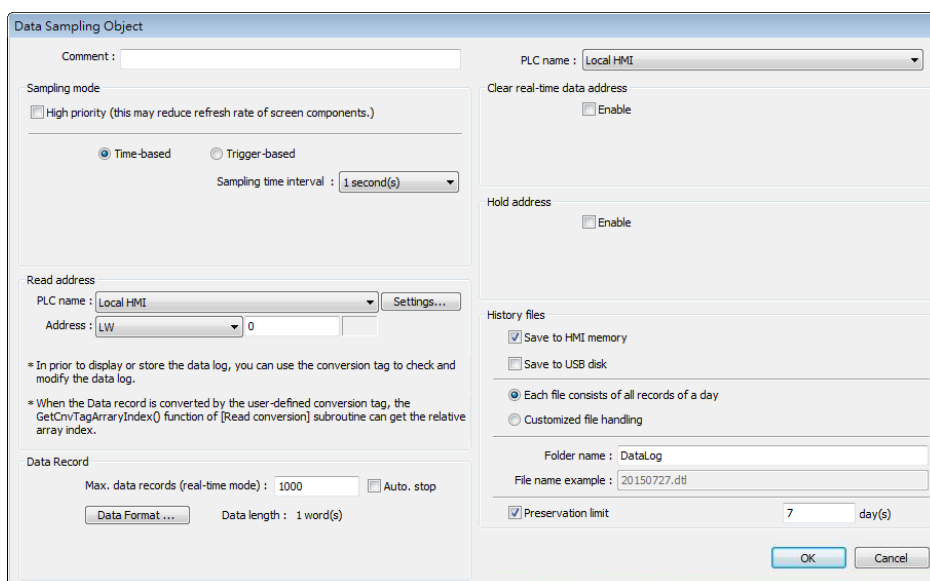

Setting	Description
Sampling mode	<p>High priority</p> <p>Data sampling processes with this feature enabled will be prioritized. Please note that too many priorities can slow down update rate of other objects.</p> <p>Time-based</p> <p>Samples data in a fixed frequency. The [Sampling time interval] can be set from “0.1 second(s) to 120 mins”.</p> <p>Trigger-based</p> <p>Triggers data sampling by the status of a designated bit address.</p> <p>Mode Conditions to trigger Data Sampling:</p> <p>[OFF -> ON] Triggers sampling when the status of the address changes from OFF to ON.</p> <p>[ON -> OFF] Triggers sampling when the status of the address changes from ON to OFF.</p> <p>[OFF <-> ON] Triggers sampling when the status of the address changes.</p> <p>Set ON/OFF after triggered</p> <p>If selected, after triggering Data Sampling, the system will set the designated bit address back to ON/OFF state.</p>
Read address	<p>Specify an address to be the source of Data Sampling. To convert a data record, please use a user-defined conversion tag that allows [Read conversion]. For array addresses, the GetCnvTagArrayIndex function can get the relative array index and then calculate.</p>
Data Record (Real-time)	<p>In Real-time Mode, when [Auto. stop] is not selected, the max. number of data records can be saved on HMI is 86400. When the number of records exceeds 86400, the earliest data will be deleted.</p> <p>Data Format</p> <p>Data of different formats in consecutive registers can be sampled. For example, setting: LW-0 (16-bit Unsigned), LW-1 (32-bit Float), and LW-3 (16-bit Unsigned).</p>

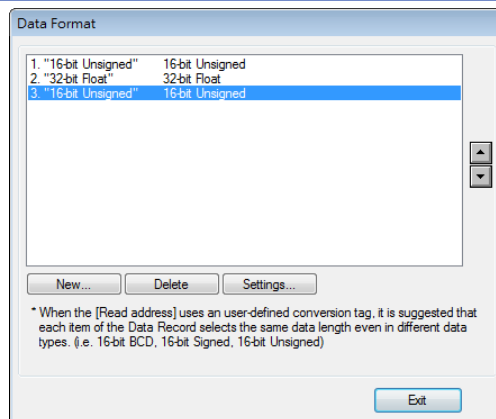

Auto. stop

Data sampling will automatically stop when the number of records reaches [Max. data records].

 See "8.3.1 Demonstration of Auto. stop".

Clear real-time data address

Set when the bit address status changes from [OFF -> ON] or [ON -> OFF], clear the sampled data in Trend Display Real-time Mode. The number of data records returns zero but the data records that are already saved as history files will not be cleared.

Hold address

If the status of the designated address is set ON or OFF, sampling will be paused until the status of the designated address returns.

History files

Save to HMI memory

Saves Data Sampling to HMI every 10 seconds. Or, use system register [LB-9034] to force storing data. See details on the restrictions of using LB-9034 in the Note below.

Save to SD card / USB disk

Saves Data Sampling to the specified external device.

Each file consists of all records of a day

The data sampling file will be saved on a daily basis into the specified folder, and the file name will be *yyyymmdd.dtl*, indicating the date of the file.

Folder name

Specify Data Sampling file name which must be all in ASCII characters. The folder name will be written as: *[Storage Location] \ [Folder Name] \ [File Name]*

Preservation limit

Determines the number of data sampling files to be

preserved. Please note that the current .dtl file is not included in this limit. That is, if this limit is set to 2, apart from the current file, two latest files will be preserved.

Customized file handling

This feature can be used to customize naming and management of data sampling files (*.dtl).



See “8.3.2 Customized File Handling”.

Note

- A Data Sampling may include more than one type of records. Data Sampling can retrieve different types of records at the same time. For example, if define three types of data, 4 words in total, the system retrieves a 4-word data each time from the designated address to be the content in one Data Sampling.
- When using [Each file consists of all records of a day] and set [Preservation limit] to 2 files, the data of yesterday and the day before yesterday will be kept. Data that is not built in this period will be deleted to prevent the storage space from running out.
- When using [Customized file handling] and set [Preservation limit] to 2 files, not only the currently sampled file, another 2 newest files (3 files in total) will be kept. The rest of the data will be deleted to prevent the storage space from running out.
- When running simulation on PC, all data sampling will be saved to the datalog folder in C:\EBPro\[Storage Location]\datalog. If you change the data format of data sampling, delete the previous data records in the installation directory to prevent the system from reading the old records.
- When saving files to USB disk or SD card, the capacity of a FAT32 folder depends on the length of the file names. Fewer files can be saved when the file names are longer.
- When using LB-9034, the shortest interval between two successful executions is 2 seconds. That is, after LB-9034 is triggered, it can be effective again 2 seconds later.

cMT Series

The settings are almost similar to eMT, iE, XE, mTV Series. The following highlights the settings that are different.

Setting	Description												
Data Record	Data of different formats in consecutive registers can be sampled.												
Control address	Entering a value in the control address sends the corresponding command.												
	<table border="1"> <thead> <tr> <th>Value</th> <th>Command</th> </tr> </thead> <tbody> <tr> <td>1</td> <td>Clear the sampled data in HMI</td> </tr> <tr> <td>2</td> <td>Synchronize data to the external device / database</td> </tr> <tr> <td>3</td> <td>Synchronize data to the external device / database and then clear the sampled data in HMI</td> </tr> <tr> <td>4</td> <td>Use the history data stored in USB disk / SD card after changing HMI</td> </tr> <tr> <td>5</td> <td>As data sampling stops when HMI storage is full, this command allows restarting of data sampling when there's free space</td> </tr> </tbody> </table>	Value	Command	1	Clear the sampled data in HMI	2	Synchronize data to the external device / database	3	Synchronize data to the external device / database and then clear the sampled data in HMI	4	Use the history data stored in USB disk / SD card after changing HMI	5	As data sampling stops when HMI storage is full, this command allows restarting of data sampling when there's free space
Value	Command												
1	Clear the sampled data in HMI												
2	Synchronize data to the external device / database												
3	Synchronize data to the external device / database and then clear the sampled data in HMI												
4	Use the history data stored in USB disk / SD card after changing HMI												
5	As data sampling stops when HMI storage is full, this command allows restarting of data sampling when there's free space												
Status & Error address	When LW-n is used as the control address, the four consecutive addresses following LW-n (LW-n+1~LW-n+4) will show status and error, please see the prompt in the settings dialog box.												

Value	Status address: LW-n+1 and LW-n+3
0	Disconnected from external device or database
1	Connecting with external device or database
2	Connected with external device or database
3	Storing records into the archive. When this is done, the value returns to 2.
Value	Error address: LW-n+2 and LW-n+4
0	None
1	Unknown error
2	Failed to connect with external device or database
3	Access denied
4	Wrong database name
5	Inconsistent data format
6	Failed to open table
7	Failed to create table
8	Failed to write table

History files

History data can be saved to USB disk, SD card, and Database Server. When the sampled data reaches 10000 records, the sampled data is automatically saved to the selected external device, and the earliest 1000 records are deleted. To save data in Database Server, please set the computer's IP address.

 See synchronization rules in "8.4 Synchronizing cMT Viewer data and Saving to External Device".

 See Database Server usage in "13.44 Database Server".

Cutomized file handling

This feature can be used to customize naming and management of data sampling files (*.db). The current

*db file is saved in HMI memory. Please note the following two points when Sync. Destination is USB disk / SD card:

1. When *db file name changes, the *.db file with the former name will be synchronized to USB disk / SD card.
2. If a new *db file is generated when there's no existing USB disk / SD card on HMI, the earlier *db file will be deleted. For example, if 20161218.db is the current file, when 20161219.db is generated and no external device is inserted to HMI, and then 20161218.db will be deleted.



Find Customized File Handling settings dialog box in "8.3.2 Customized File Handling".

Auto sync. periodically	Data will be automatically synchronized to the designated external device in the specified time interval, regardless of the rules explained above. Please note that the timer will reset when a control address is used.
	See "8.4 Synchronizing cMT Viewer data and Saving to External Device or Database Server".
All record in one file	When Sync. Destination is USB disk / SD card, the preservation limit is 1 to 65535 days.
Customized file handling	When Sync. Destination is USB disk / SD card, the preservation limit is 1 to 65535 files. When Sync. Destination is HMI memory, the preservation limit is 1 to 1000 files.
Display history from database	With this option selected, Data Sampling displays the history data read from database.

8.3.1. Demonstration of Auto. stop

This feature depends on the arrangement of different objects and modes. (Set [Max. data records] to n.)

Object	[Auto. stop] not selected	[Auto. stop] selected
Trend Display- Real time	Deletes the earlier records and displays the latest number of records (n) in Trend Display. See the following figure.	Stops after reaching the specified number of data records (n).
Trend Display- Historical	Keeps on sampling data and displays all history data in Trend Display.	Stops after reaching the specified number of data records (n).
History Data Display	Keeps on sampling data and displays all history data in History Data Display.	Stops after reaching the specified number of data records (n).
Data Sampling	Keeps on sampling new data.	Stops after reaching the specified number of data records (n).

The figure illustrates how the data is sampled in Trend Display – Real Time mode when [Auto. stop check] box is not selected. Set the number of data records to 10, when the 11th data is generated, the earliest record is deleted and the newest record is added.

Record Number	Data	Not selecting [Auto. stop]
1	101	102
2	102	103
3	103	104
4	104	105
5	105	106
6	106	107
7	107	108
8	108	109
9	109	110
10	110	111
11	111	



8.3.2. Customized File Handling

This feature can be used to customize naming and management of data sampling files (*.dtl, *db).

Customized File Handling

File creation

Automatic mode (A new file will be created when the file name is changed.)

Trigger mode (Use the trigger method to create a new file.)

Trigger method

Limit by number of data records
Max. data records in a file : 1000

Register status
Mode : OFF->ON Set OFF after triggered

PLC name : Local HMI

Address : LB 0

File name

Dynamic format

Year (1911-2048) Year (00-99) Month (01-12) Day (01-31)

Week (00-53) Weekday (0-6)

Hour (00-23) Minute (00-59) Second (00-59) %

Format : %Y%m%d .dtl
Example : 20141121.dtl

%Y Year (1911-2048)
%y Year, last two digits (00-99)
%m Month as a decimal number (01-12)
%d Day of the month (01-31)
%W Week number (00-53)
%w Weekday, 0 is Sunday (0-6)
%H Hour in 24h format (00-23)
%M Minute (00-59)
%S Second (00-59)
%% %

* A filename cannot contain any of the following characters: \ / : * ? " < > |

Setting	Description
File creation	<p>Automatic mode A new file will be created when the name of an existing file is changed.</p> <p>Trigger mode A new file will be created according to the [Trigger method] settings.</p>
Trigger method	<p>Limit by number of data records A new file will be created when the number of data sampling records reaches the specified "Max. data records in a file"</p> <p>Register status A new file will be created when the status of a designated bit address meets the specified condition. The condition is specified in Mode field.</p> <p>Set ON/OFF after triggered If selected, after the new file is created, the system will</p>

set the designated bit address back to ON/OFF state.

File name

The file name can be an alphanumeric name, and certain half-width symbols are allowed. The file name can also be specified by a file name syntax.

Dynamic format

The file names can be set by a designated word address, or by a file name syntax indicating the current system time. The file name syntax can be specified by selecting time buttons or entering the syntax in Format field. The length limit is from 1 to 25.

The following half-width characters are not allowed:

\ / : * ? " < > |

Note

- If both [Limit by number of data records] and [Dynamic format] check boxes are selected, before startup HMI, please enter the name in the designated register for Dynamic Format, otherwise, it is impossible to reach the "Max. data records in a file", and the data sampling file will not be generated.
- When a new file is generated, the system will first detect if the filename already exists. If the file name does exist, the newly sampled data will be appended to the existing file.

8.4. Synchronizing cMT Viewer data and Saving to External Device or Database

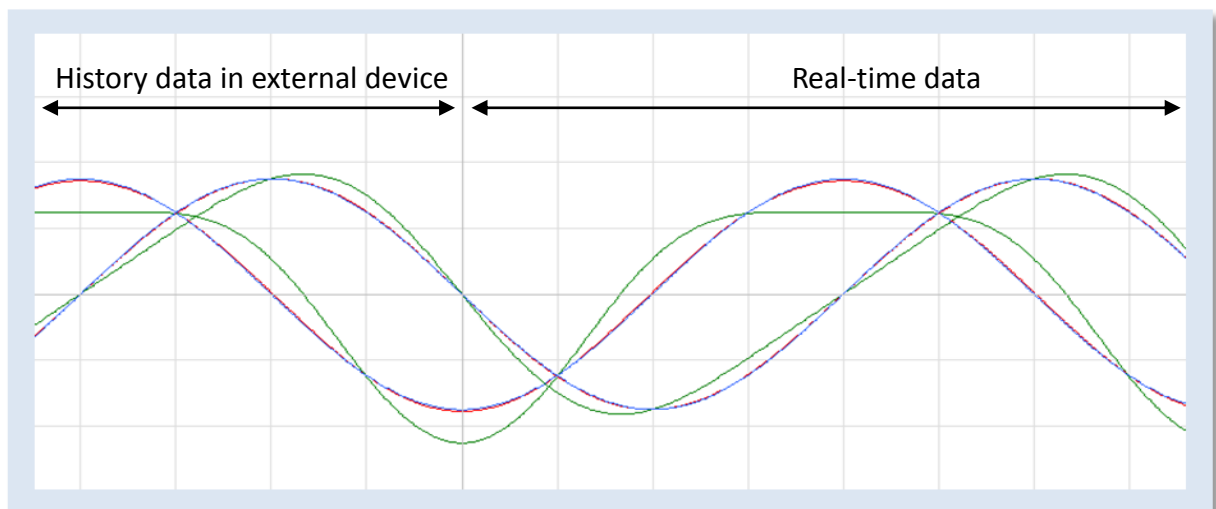

For other series, when displaying the sampled data in Trend Display object, it is necessary to select from Real-time mode or History mode and the two modes cannot simultaneously be displayed in one object.

cMT Series allows displaying history data and at the same time updates real-time data in one Trend Display or History Data Display object. The data saved in the external device can be

updated.

The rule of synchronizing the data saved in the external device:

1. When the sampled data reaches 10000 records, HMI will automatically save data to the external device and deletes the earliest 1000 records in HMI.
2. If the external device is removed from HMI, and inserted back again at the time when the sampled data is under 9000 records, the data generated during the time the external device is removed is saved in HMI and is not cleared. If the data exceeds 9000 records during the time the external device is removed, the earlier data is cleared and cannot be synchronized even to insert the external device back to the HMI.
3. If there already exists sampled data in the external device, the new data is appended without overwriting the original data each time in synchronization.

8.5. Checking History Data of a Specific Date / File on cMT Viewer.

To check the history data, see the following steps (Use Trend Display object as example).

1. Tap the  icon in the upper-right corner of the Trend Display object.
2. The following dialog box appears.

Cancel	Option	Done
FILE SELECTION		
	(Current)	✓
	20161228_115444	
	20161219_151520	
	20161219_151504	
	20161219_151454	
	20161219_151444	
TREND DISPLAY SETTING		
	Channel Visibility	
	Y Scale	Off
Reset to project default		

3. Specify the date or the file.

Cancel	Option	Done
FILE SELECTION		
	(Current)	
	20161228_115444	✓
	20161219_151520	
	20161219_151504	
	20161219_151454	
	20161219_151444	
TREND DISPLAY SETTING		
	Channel Visibility	
	Y Scale	Off
Reset to project default		

4. Tap [Done] button to finish setting.

9. Object General Properties

This chapter explains the basic settings of an object.

9.1.	Overview.....	9-2
9.2.	Selecting PLC and Setting Read/Write Address.....	9-2
9.3.	Using Shape Library and Picture Library.....	9-3
9.4.	Setting Label Text.....	9-7
9.5.	Adjusting Profile Size	9-9

9.1. Overview

The basic steps to create an object:

1. Selecting the PLC device and setting the read/write address.
2. Using Shape Library and Picture Library.
3. Setting label text.
4. Adjusting profile size.

This chapter explains the basic settings of an object.

9.2. Selecting PLC and Setting Read/Write Address

Most objects read data from PLC devices, so a properly configured PLC address is needed. Select the PLC to control at [PLC name] which comes from [System Parameters Settings] » [Device List].

Setting	Description
PLC name	Select the PLC type.
Device type	Different PLCs have different device types.
Address	Set the read/write address.
System tag	Address tags include [System Tag] and [User-defined Tag]. This option allows users to use [System Tag]. [System Tag] consists of the preserved addresses by system for particular purposes. The address tags include bit registers or word registers (LB or LW). After selecting [System tag], not only will the [Device type] field display the chosen tag, but [Address] field will also display the chosen register.

Index register

Select this check box to use the [Index Register]. Certain objects require data type setting. The following data types are supported in EasyBuilder Pro, Selecting correct data type is necessary especially when using address tag.

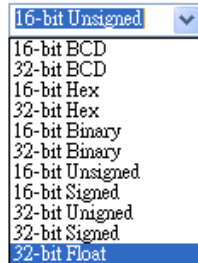

- ☞ For more information about System Tag, see “22 System Reserved Words and Bits”.
- ☞ For more information about Index Register, see “11 Index Register”.
- ☞ For more information about Tag Library, see “16 Address Tag Library”.

9.3. Using Shape Library and Picture Library

In the settings dialog box of certain objects, “Shape” tab can be found. In this tab, Shape Library and Picture Library can be used to add visual effects on objects. Select Shape tab to use the libraries when creating an object.

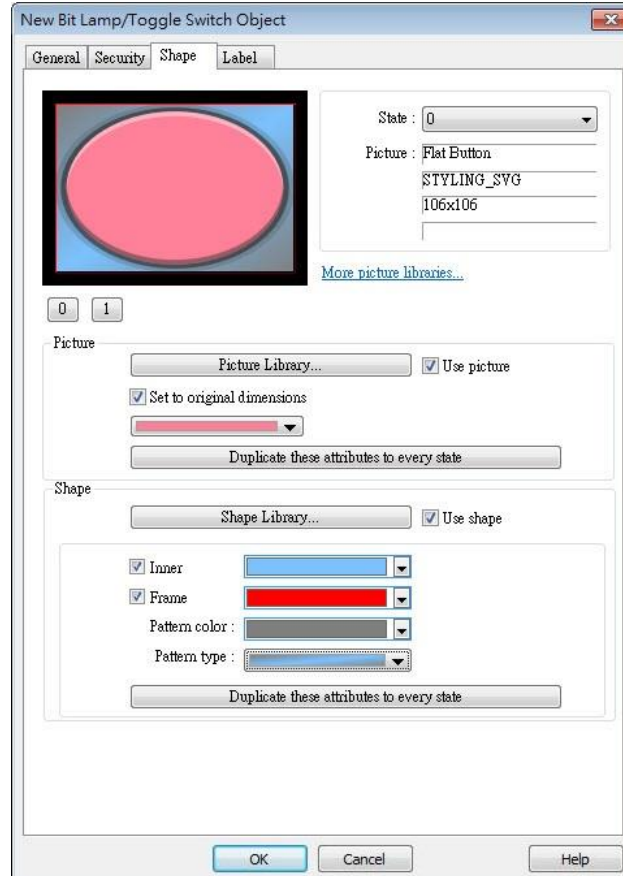

9.3.1. Picture

Select [Use picture] and then click [Picture Library] button to open Picture Manager window, and select a picture from the window.

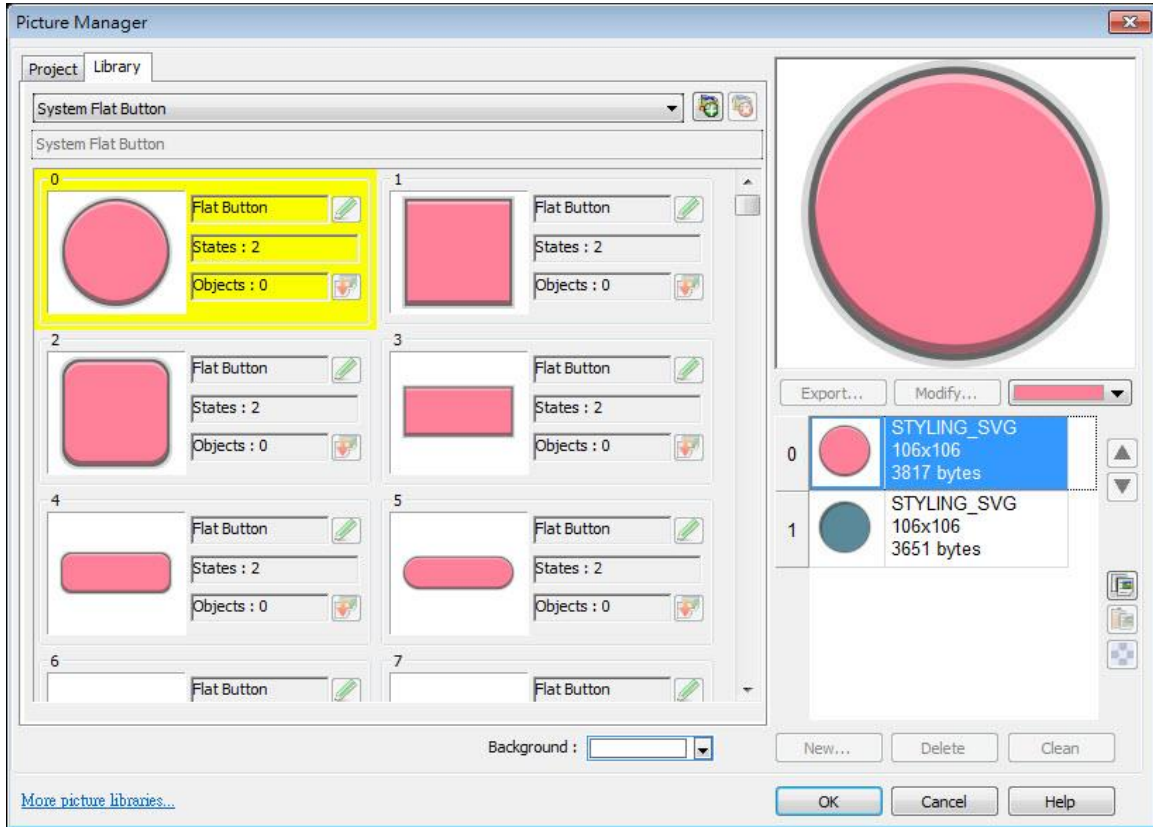

Setting	Description
Picture Library	Click [Picture Library] button in Picture group box to open Picture Manager window.
Set to original dimensions	When this checkbox is selected, EasyBuilder will return the picture to its original size to eliminate the redrawing step.
Duplicate these attributes to every state	This button is available only when a system picture is used. Clicking this button will duplicate the attributes of the current picture to other states.

9.3.2. Shape

Select [Use shape] and then click [Shape Library] button to open Shape Manager window, and select a shape from the window.

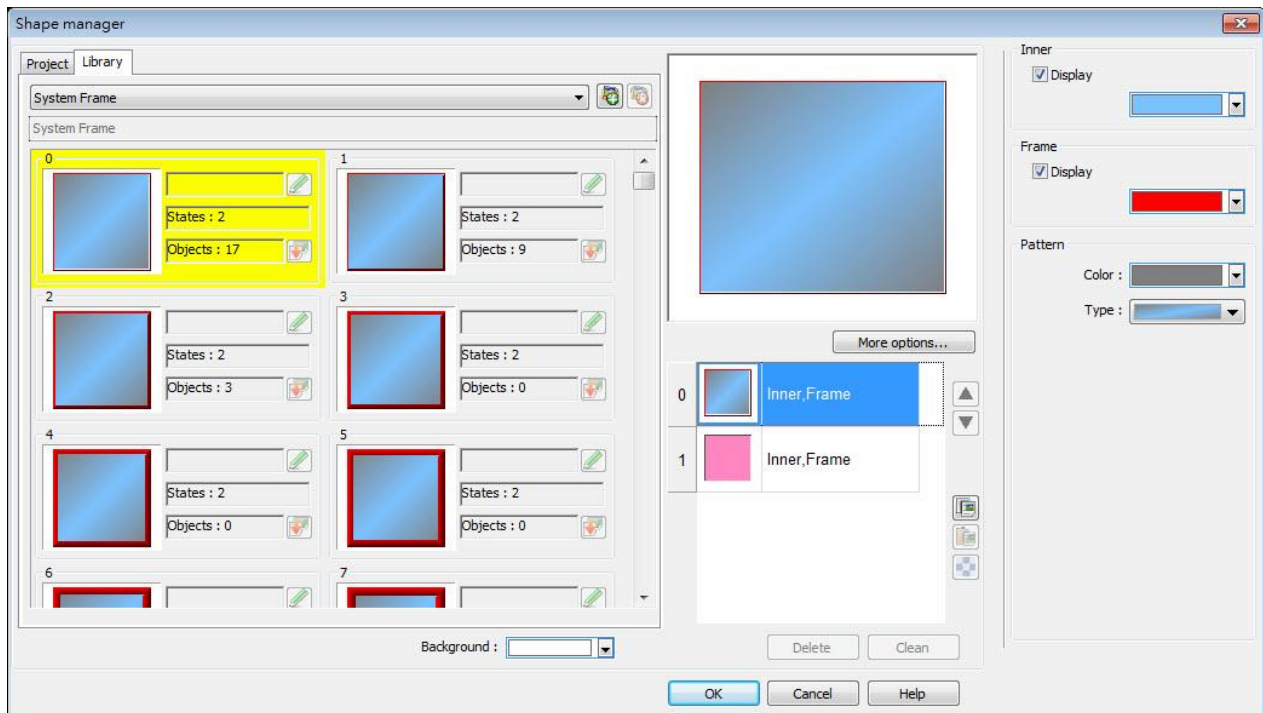

Setting
Description

Inner

Select [Display] to show the inner color of the shape, and select a color as the inner color by clicking the drop down button.

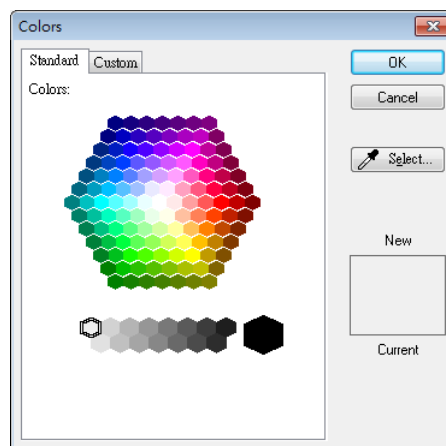
**Frame**

Select [Display] to show the frame color of the shape, and select a color as the frame color by clicking the drop down button.

Pattern color

Click the drop down button to select a color for the interior pattern of the shape.

Pattern type

Click the drop down button to select a pattern.

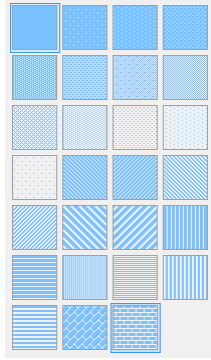

Duplicate these attributes to every state

Duplicate the attributes of the current state to other states.

9.3.3. Shape manager

In Picture Manager and Shape Manager windows, the currently selected picture / shape is highlighted yellow as shown below.

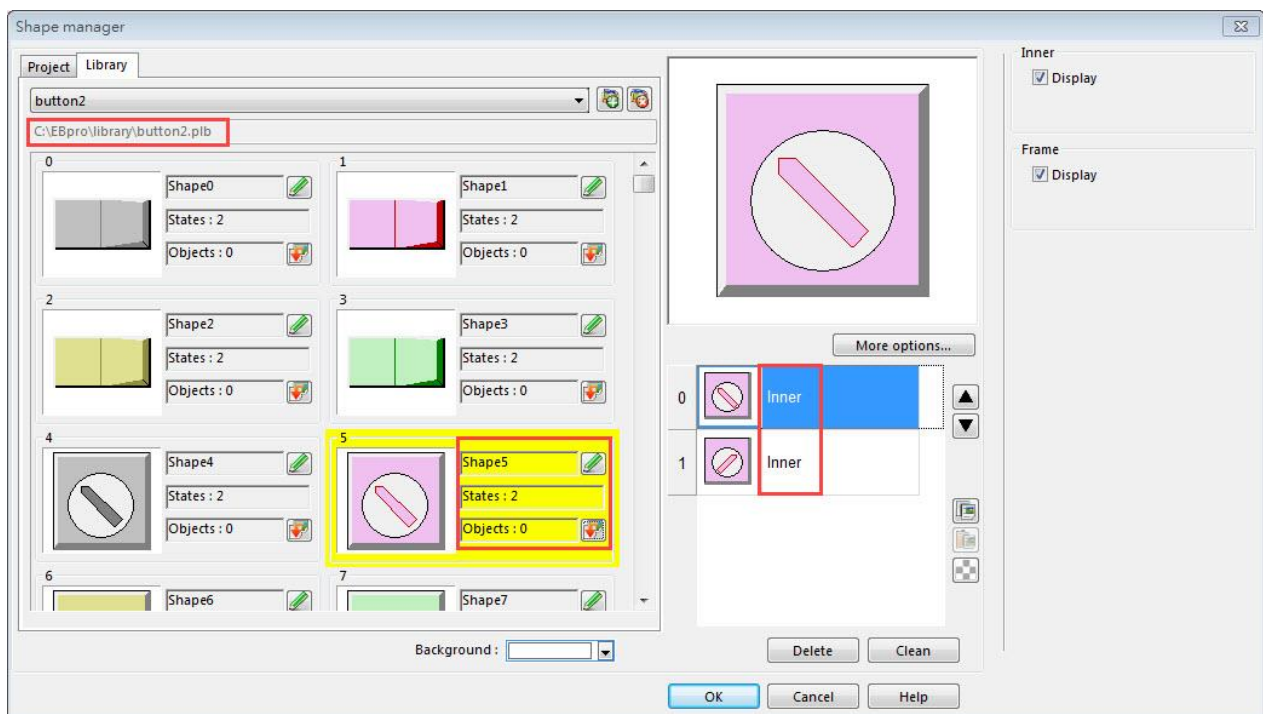

The information about the selected picture / shape:

Directory The directory from which EasyBuilder searches for the pictures / shapes.

Shape5 Name of the shape.

States: 2 Number of states of the shape.

Objects: 1 This shape is used by 0 object in the project.

Inner The state 0 and state 1 of this shape contain only “inner” but not “frame.”



For more information, see “14 Shape Library and Picture Library”.

9.4. Setting Label Text

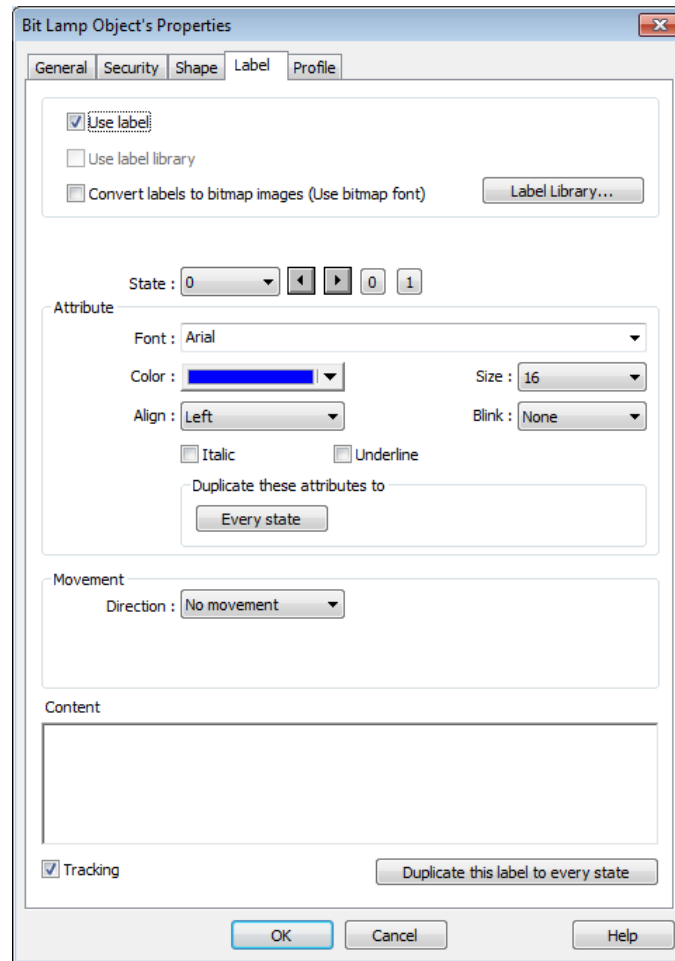

Setting	Description
Use label	Select this check box to use labels for the object.
Use label library	Select this check box to choose a label in Label Library.
Use bitmap font	Select this check box to convert the label text into bitmap format.
Label Library	Browse Label Library 👉 For more information, see “15 Label Tag Library and Multi Language”.
Font	Select a font from the list. EasyBuilder Pro supports Windows True-type fonts. For cMT-SVR Series, if the font is followed by another font enclosed by parentheses, the enclosed font is the one used in iPad.

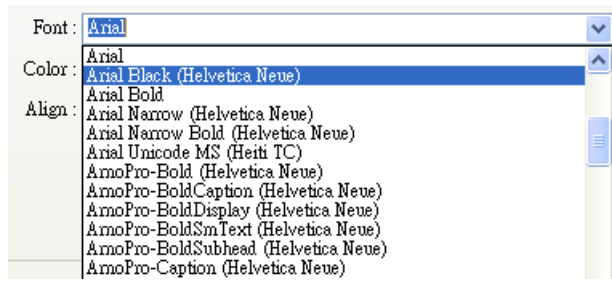

Color	Select the font color.
Size	Select the font size.
Align	The text aligned [Left] [Center] [Right] 111 111 111 222222 222222 222222 3333333333 3333333333 3333333333
Blink	Specify the way the text blinks. Choose [None] to disable this feature or set the blinking interval to [1 second] or [0.5 seconds].
Italic	Use Italic font. <i>Italic Label</i>
Underline	Use Underline font. <u>Underline Label</u>
Movement	<p>Direction Set the direction of the marquee effect. The directions include: [No movement], [Left], [Right], [Up], [Down].</p> <p>Continuous Specify how the marquee effect is displayed. If not selecting this check box, the next text appears only when the previous text disappears completely.</p> <p>Alarm irm</p> <p>If selecting this check box, the text will be displayed continuously.</p> <p>rm Alarm A</p> <p>Speed Adjust the speed of the text movement.</p>
Content	Set the content of the text. If [Label Library] is used, it will automatically use the text defined in Label Library.

Tracking	If this check box is selected, when changing the position of the text in one state, the text position in the other states will also change in accordance.
Duplicate this label to other state	Duplicate the current text to the other states.

Note

- When Text/Comment object is used with Comment enabled, the text used as comment will not appear on HMI.

9.5. Adjusting Profile Size

When an object is created and placed in the editing screen, double click it and select the [Profile] tab to adjust the position and size of the object.

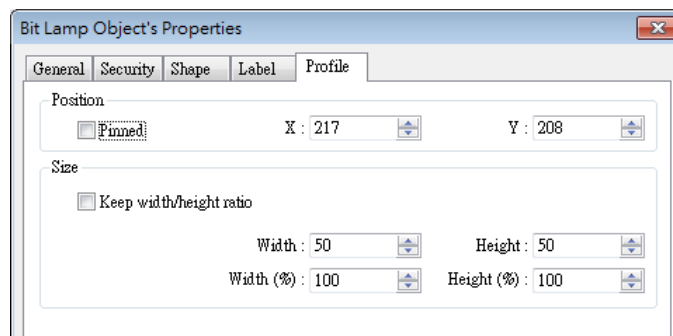

Setting	Description
Position	<p>Pinned</p> <p>When this check box is selected, the position and the size of the object cannot be changed.</p> <p>[X] and [Y]</p> <p>The coordinates of the position of the object in the editing screen.</p>
Size	Adjust the [width] and [height] of the object.

10. User Password and Object Security

This chapter discusses the protection for operations provided by setting up user passwords and security classes.

10.1. Overview.....	10-2
10.2. User Password and Operable Object Classes	10-2
10.3. Enhanced Security Mode and Control Address.....	10-3
10.4. Enhanced Security Mode Usage	10-7
10.5. Object Security Settings.....	10-12
10.6. Example of Object Security Settings.....	10-13
10.7. Protecting Password Settings from Unauthorized Editing	10-16

10.1. Overview

This chapter discusses the protection for operations provided by setting up user passwords and security classes. There are two authentication modes:

- General Mode
- Enhanced Security Mode

Each mode will be introduced later.

To set up the protection system, please:

1. Set user password and operable classes.
2. Set object class for objects.

An object belongs only to one security class. Setting the object class to “None” means any user can operate this object.

10.2. User Password and Operable Object Classes

The security parameters can be found in [Edit] » [System Parameter Settings] » [Security]. Two modes are available: General Mode and Enhanced Security Mode.

10.2.1. General Mode

Up to 12 sets of user and password are available. A password should be one non-negative integer. There are six security classes: A to F.

Once the password is entered, the objects that the user can operate are classified. As shown below, “User 1” can only operate objects with class A or class C.



Note

- General Mode is not available for cMT Series.

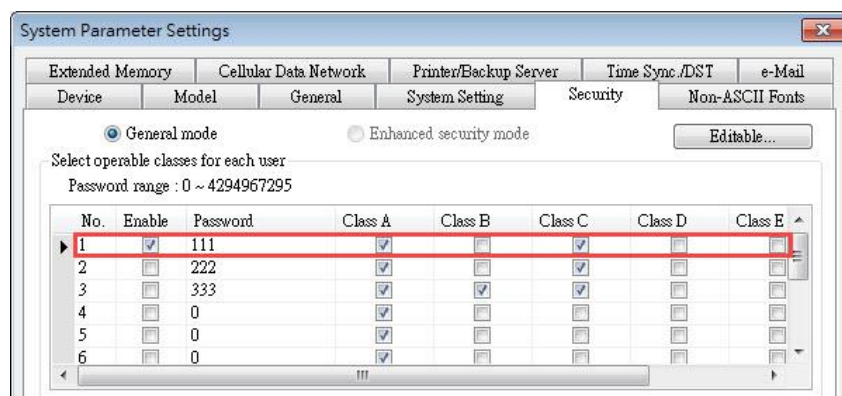

10.2.2. Enhanced Security Mode

Up to 11 users can be set here. In addition, [Administrator] setting is provided. Administrator has all privileges and can operate all object classes. User passwords must be alphanumeric characters and each user can have up to 12 operable classes: A to L. (Up to 127 users can be set in Administrator Tools. Please see “10.4 Enhanced Security Mode Usage” for more details.)

Enhanced Security Mode provides a [Control address] for users to manage the accounts directly on HMI. Please see “10.3 Enhanced Security Mode and Control Address” for more details. Alternatively, use USB Security Key to log in automatically. Insert the device in which the key is saved to log in. Please see 10.4.3 Login / Logout Automatically with USB Security Key” for more details.

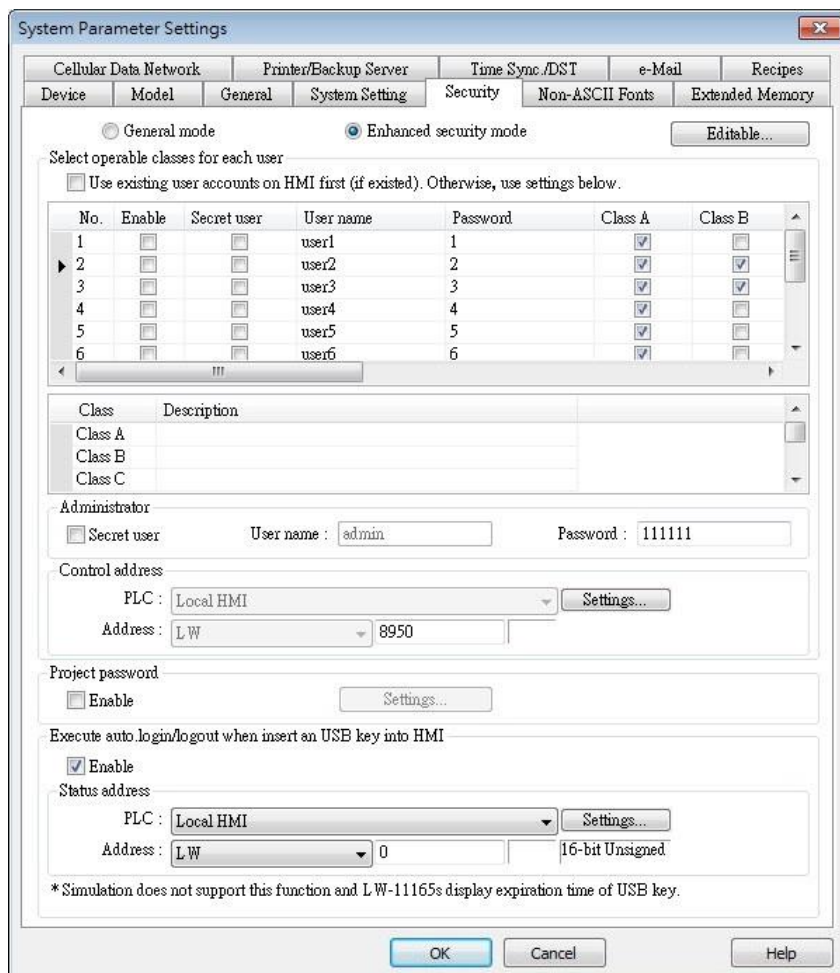

10.3. Enhanced Security Mode and Control Address

The Control Address is used for login and account management. The Control Address can only be assigned to LW register on Local HMI, and 20 consecutive registers will be used. To log in using Control Address, please select to log in by [user name] or [user index].

Please set [user name] and [password] in [System Parameter Settings] » [Security] » [Enhanced security mode] in advance.

10.3.1. Control Address Settings

When control address is set to LW-n, where n is an arbitrary number, the following addresses will be designated:

Address	Tag Name	Description
LW-n (1 word)	command	Commands to be executed: Login, Logout, Add/Setting/Delete Accounts, etc.
LW-n + 1 (1 word)	command execution result	Displays the result of executing commands.
LW-n + 2 (1 word)	user index	The index of accounts (used with Option List Object).
LW-n + 3 (1 word)	user privilege	Binary value. Level A = bit0, Level B = bit1, ...
LW-n + 4 (8 words)	user name	Account name (Case-sensitive and only allows letters and numbers).
LW-n + 12 (8 words)	password	Account password (Case-sensitive and only allows letters, numbers, or special characters).

After setting the [Control address], the relevant addresses can be found in [Address Tag Library] » [Customized]. For example, setting [Control address] to LW-0: (UAC stands for User Account Control)

LW-0 → [UAC command]

LW-1 → [UAC command execution result]

LW-2 → [UAC user index]

LW-3 → [UAC user privilege]

LW-4 ~ LW-11 → [UAC user name]

LW-12 ~ LW-20 → [UAC password]

Note

- In Enhanced Security Mode, if cMT Series model is used, the Control Address can only be assigned to PLW register of Local HMI.

10.3.2. Commands

Setting different values in LW-n [command] enables different commands:

Set Value	Command	Corresponding Address
1	Log in by user name	Set [user name] and [password] first. After entering the user name and password, the

		system will check if they are valid in [System Parameter Settings] » [Security] » [Enhanced security mode].
2	Log in by user index	Set [user index] and [password] first. Please refer to 10.4.4 Enhanced Security Mode with Option List Object.
3	Log out	
4	Change the password of current logged-in user	Set [user name] and [password] first. Please fill in the original password in [user name] and new password in [password].
5	Add an account	Set [user name], [password] and [user privilege] first.
6	Add a temporary account (minutes)	Set [user name], [password], [user privilege], and [user index] first. [user index] is for specifying a time period (in minutes), within this period the account is valid. If 0 is specified, this account stays valid until the HMI is powered off.
7	Delete an existing account by user name	Set [user name] first.
8	Delete an existing account by user index	Set [user index] first.
9	Setting the privilege of an existing account by user name	Set [user name] and [user privilege] first.
10	Setting the privilege of an existing account by user index	Set [user index] and [user privilege] first.
11	Setting the password of an existing account by user name	Set [user name] and [password] first.
12	Setting the password of an existing account by user index	Set [user index] and [password] first.
13	Read the privilege of an existing account by user name	Set [user name] first. If the command succeeds, [user privilege] can be displayed.
14	Read the privilege of an existing account by user index	Set [user index] first. If the command succeeds, [user privilege] can be displayed.
15	Add a temporary account (days)	Set [user name], [password], [user privilege], and [user index] first. [user index] is for specifying a time period (number of days), within this period the account is valid. If 0 is specified, this account stays valid until the HMI is powered off.

16	Add an expiring account (minutes)	Set [user name], [password], [user privilege], and [user index] first. [user index] is for specifying a time period (in minutes), within this period the account is valid. 0 is an invalid value for this setting.
17	Add an expiring account (days)	Set [user name], [password], [user privilege], and [user index] first. [user index] is for specifying a time period (number of days), within this period the account is valid. 0 is an invalid value for this setting.
18	Remaining minutes for user name	Set [user name] first. If succeeded, the remaining time (in minutes) will be displayed in [user index].
19	Remaining minutes for user index	Set [user index] first. If succeeded, the remaining time (in minutes) will be displayed in [user index].
20	Remaining days for user name	Set [user name] first. If succeeded, the remaining time (number of days) will be displayed in [user index].
21	Remaining days for user index	Set [user index] first. If succeeded, the remaining time (number of days) will be displayed in [user index].

 **Note**

- Add a temporary account / expiring account: The difference between temporary accounts and expiring accounts is that temporary accounts are not stored in the system and will be invalid after HMI is turned off. Both temporary accounts and expiring accounts will be automatically deleted when they are expired.
- Delete the existing account: The currently logged in account cannot be deleted.
- Offline/Online Simulation: Simulate using the account settings in the program. Any modifications of the account during simulation will not be reserved for next simulation.
- admin: Default administrator account, cannot be deleted, has all privileges and cannot be changed.
- System Register LW-10754: Displays current user name.
- System Register PLW-10754: Displays current user name. (Only available for cMT Series)
- The [user privilege] address does not display the privileges assigned to current user account, please use system register LW-9222 to display the privileges.

10.3.3. Command Execution Results

After the command is executed, the system will store the result code to control address LW-n +

1. The listed result codes below are shown in hexadecimal format.

Result Codes	Command execution result
(0x001)	Succeeds
(0x002)	Invalid command
(0x004)	Account exists (when adding a new account)
(0x008)	Account not exists
(0x010)	Password error
(0x020)	Deny command
(0x040)	Invalid name
(0x080)	Invalid password character exists
(0x100)	Invalid import data
(0x200)	Out of validity range (when log in by USB Security Key). The [Effective Time] can be set in Administrator Tools.



Note

- Users can add a new event in Event (Alarm) Log, and designate the [Read address] to LW-n + 1 [command execution result]. Open [Message] tab » [Text] » [Content] and specify the message to be displayed in Event Display Object for showing command execution result.

10.4. Enhanced Security Mode Usage

10.4.1. Importing User Accounts

The user accounts can be set using other tools we provide, apart from the settings in [System Parameter Settings] » [Security] tab. Administrator Tools can also be used to set user accounts. Administrator Tools can be found in the installation directory. After the program starts, select the [User Accounts] check box. Up to 127 accounts can be added.

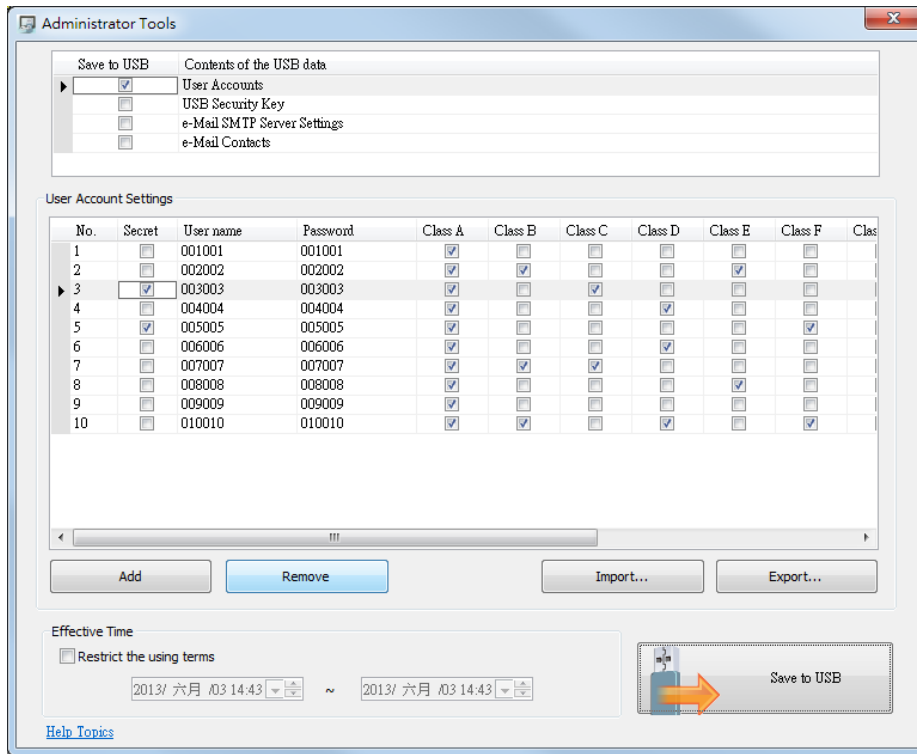

For more information, see “36 Administrator Tools”.

The added accounts can be stored in USB disk or SD card and imported in HMI by a Function Key Object. To do so, create a Function Key Object, and select [Import user accounts].

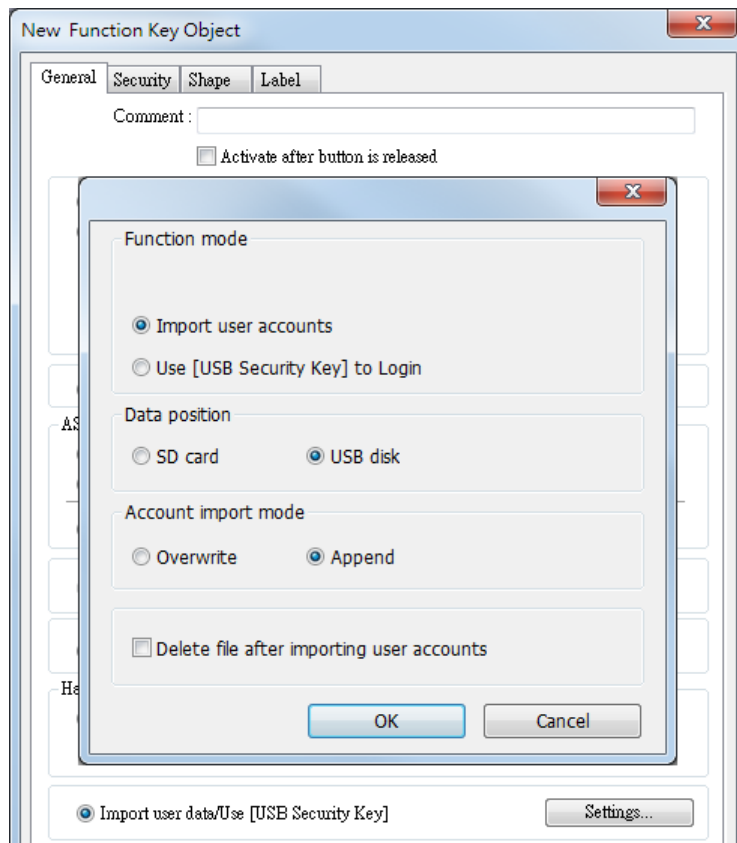

When finished, insert the external device to HMI, and press Function Key to import accounts. If [Overwrite] is selected, the existing accounts will be overwritten with new accounts and automatically log out after importing. If select [Delete file after importing user accounts] check box, the system will delete the account data saved in the external device after importing. If the [Effective Time] in Administrator Tools is specified, the importing can only be done in the time limit specified. The imported accounts will not be deleted by system when the effective time ends.

10.4.2. Login with USB Security Key

Instead of entering user name and password to login, a key can be used to do so. In EasyBuilder Pro installation directory, launch Administrator Tools, select [USB Security Key] check box. The account information uses the predefined data in [System Parameter Settings] » [Security].

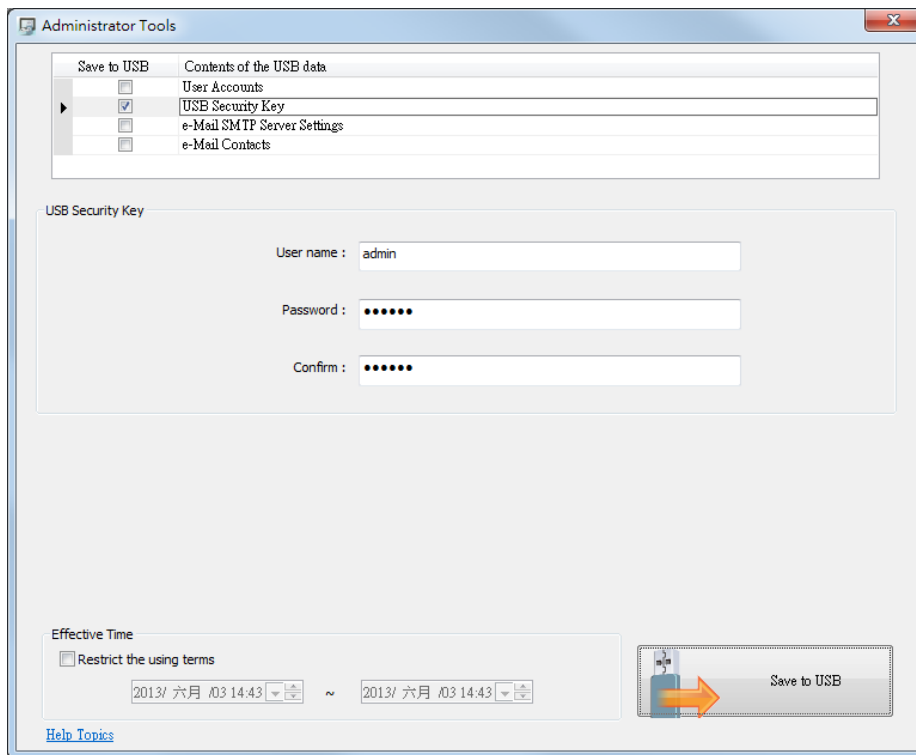

Note

- Please note that the user accounts used for USB Security Key must already exist in HMI.

For more information, see “36 Administrator Tools”.

USB Security Key can be stored in USB disk or SD card, and create a Function Key to log in by USB Security Key as shown below:

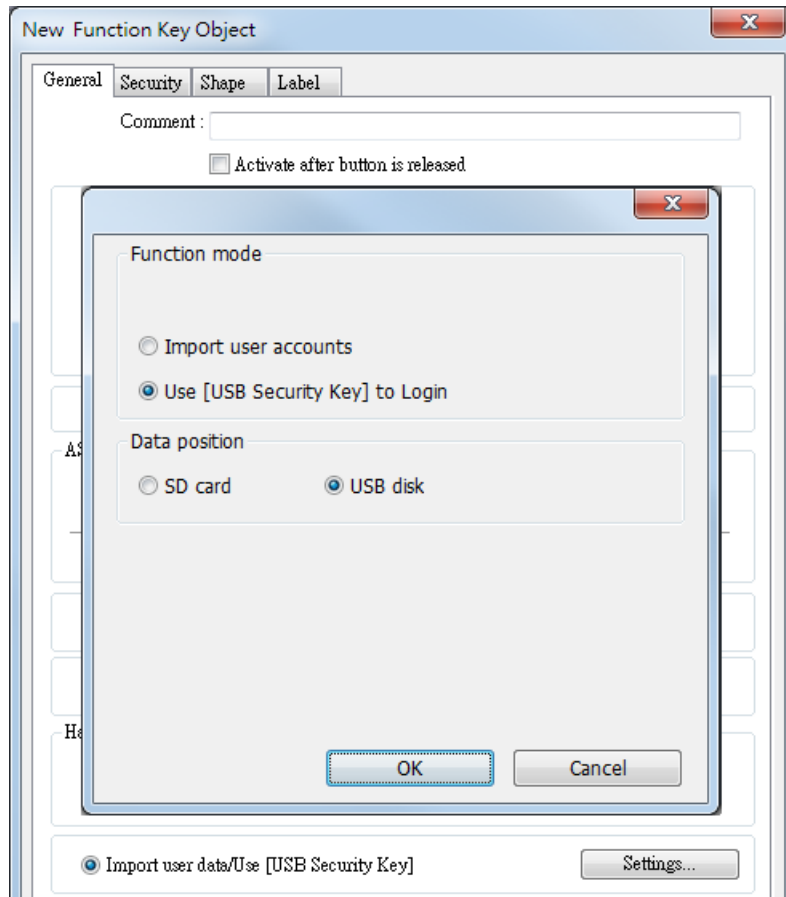

When finished, insert the external device to HMI, and press Function Key to log in using USB Security Key. If the [Effective Time] in Administrator Tools is specified, the login can only be done in the time limit specified. The system will log out automatically when the key expires.

10.4.3. Login / Logout Automatically with USB Security Key

As shown below, in [System Parameter Settings], select [Enable] check box for [Execute auto. Login / logout when insert an USB key into HMI].

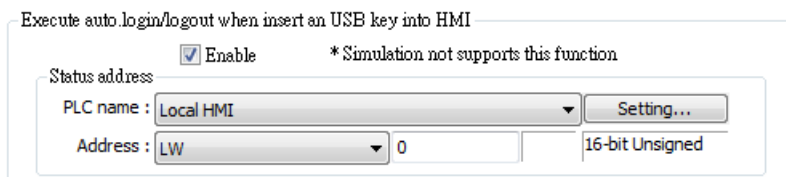

This function allows automatic login / logout using an USB security key. Insert the USB disk in which the key is saved to HMI to log in, and remove the USB disk to log out. The login / logout status will be written into a designated address, the result codes of login / logout:

- 0x00: No Action
- 0x01: Login Succeeds
- 0x04: Login Fails
- 0x08: Login Succeeds
- 0x10: Logout Fails

 For more information about USB Security Key, see “36 Administrator Tools”.

Note

- When Auto Login / Logout is enabled, log in by [Function Key] object is not possible, but it is still possible to log in / out with a designated control address.
- This function does not support On-line / Off-line simulation.
- Only the USB Security Key saved in USB disk is valid.

 Click the icon to download the demo project that explains how to use USB Security Key to log in / out. Please confirm your internet connection before downloading the demo project.

10.4.4. Enhanced Security Mode with Option List Object

Enhanced Security Mode uses Control Address LW-n + 2 as account index. With Option List Object, account names and privileges can be displayed. Users can select whether or not to display the account privileges and secret users in Option List. Secret users are set to be hidden in [System Parameter Settings] » [Security] » [Enhanced Security Mode]; their account names will be hidden in Option List if [Secret user] check box is not selected. If the control address is set to LW-0, the monitor address for index of Option List is designated to LW-2.

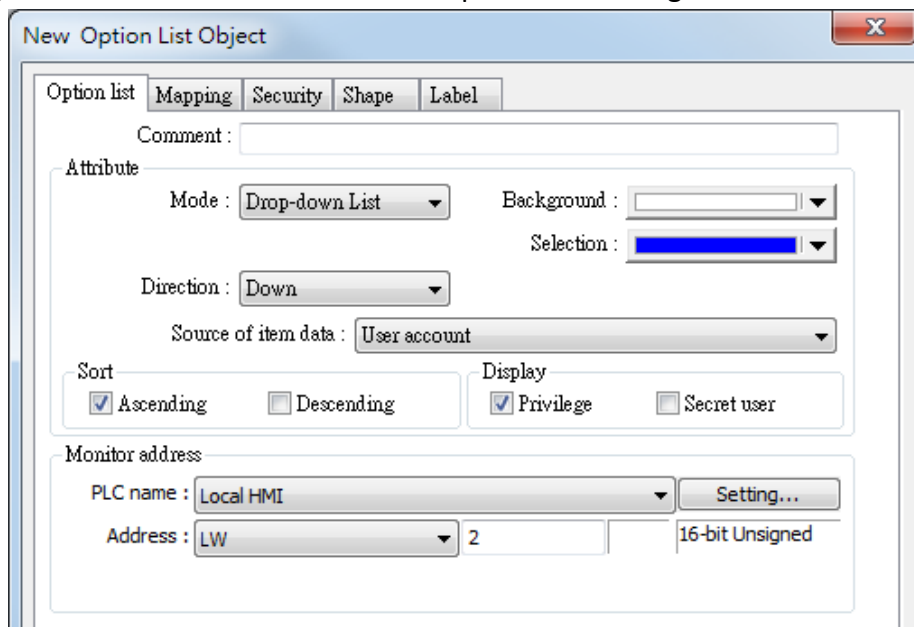

 Click the icon to download the demo project that explains more about Enhanced Security Mode. Please confirm your internet connection before downloading the demo project.

10.5. Object Security Settings

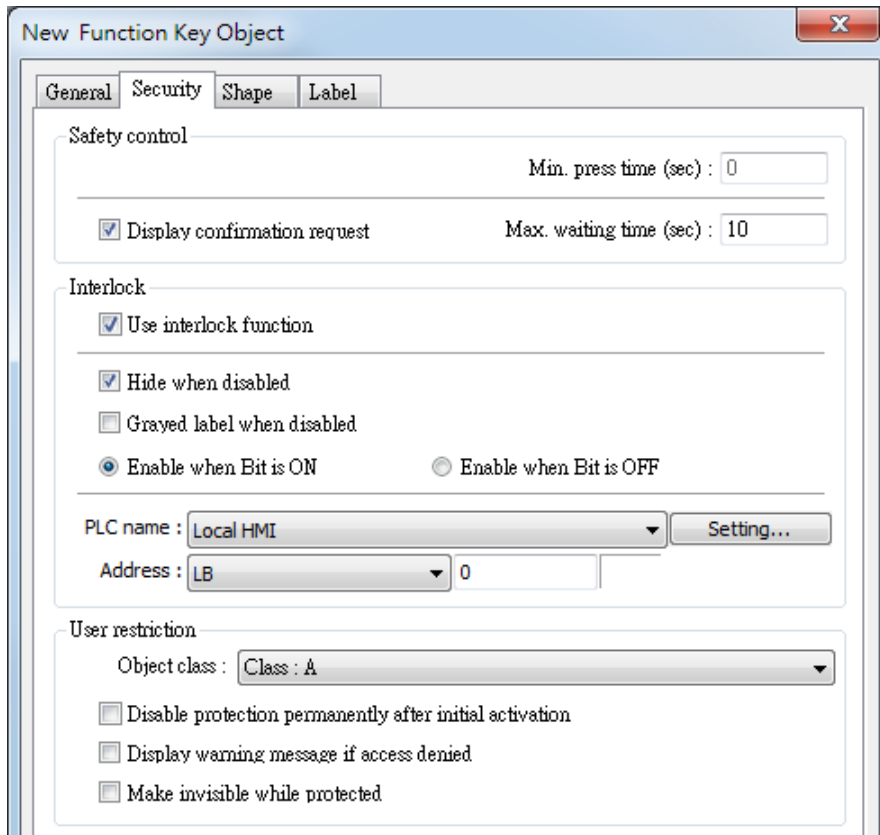

Setting	Description
Safety control	<p>[Min. press time (sec)] Press and hold the object for longer than the [Min. press time] set here to activate the object.</p> <p>[Display confirmation request] After pressing the object, a dialog appears for operation confirmation. If the response to this dialog comes later than the set [Max. waiting time (sec)], this dialog disappears automatically and the operation will be canceled.</p>
Interlock	<p>When this check box is selected, the specified Bit address is used to enable or disable the object. As shown, if LB-0 is ON, the object is enabled.</p>

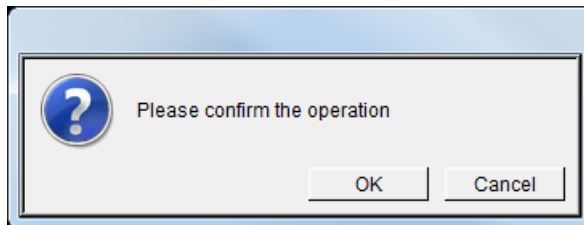

Hide when disabled

When the specified Bit is OFF, hide the object.

Grayed label when disabled

When the specified Bit is OFF, the label of the object turns gray.

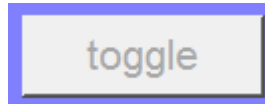

For details on interlock bit address setting of Set Word and Numeric objects, see Chapter 13.4 or 13.9.

User restriction

Set the security class of the object to be operated by an authorized user.

Object class

"None" means any user can operate this object. Only account "admin" can operate "Administrator" object class.

Disable protection permanently after initial activation

Once the permitted class of the user matches that of the object, the system will stop checking the security class permanently, that means, any user can operate this object freely after it is unlocked.

Display warning message if access denied

When an unauthorized user attempts to operate the object, a warning dialog (Window no. 7) appears. The content of the message in the dialog can be modified.

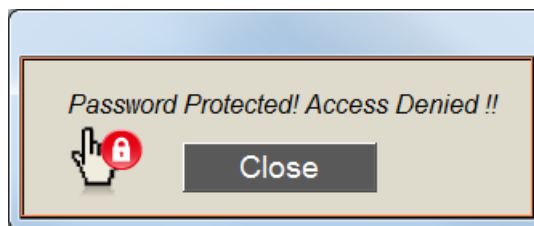
**Make invisible while protected**

When the user's privilege does not match the object class, hide the object.

10.6. Example of Object Security Settings

The following shows an example of setting object security class:

1. Create a project, go to [System Parameter Settings] » [Security] » [General] to enable 3 users:
 User 1 = Operable class: A
 User 2 = Operable class: A, B
 User 3 = Operable class: A, B, C
2. Design Window no. 10 as shown:

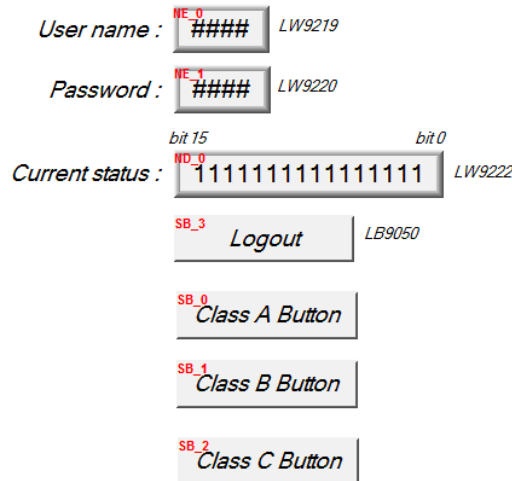

Create two [Numeric Input] objects:

[LW-9219] User no. (1~12), Length = 1word

[LW-9220] For entering user password. Length = 2 words

Create a [Numeric Display] object:

[LW-9222] Displays the status of current user. (16-bit Binary)

Create a [Set Bit] object

[LB-9050] logout

Create three [Set Bit] objects:

Each set to different classes but all select [Made invisible while protected].

3. After setting, please save and compile the project and execute off-line simulation. The below shows how it works when simulating.

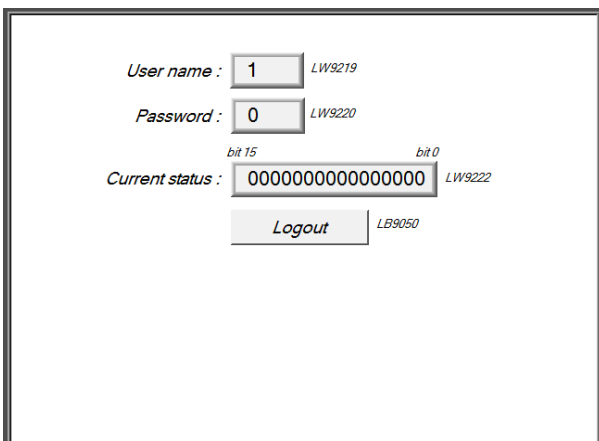

Before entering the password, it displays “0000000000000000”, which means that the user operable object class is “None”. [Class A Button] ~ [Class C Button] objects are classified from “A” to “C” and selected [Made invisible while protected]; therefore they are hidden at this moment.

User name : LW9219

Password : LW9220

Current status : LW9222
bit 15 bit 0

LB9050

Enter User 1 password "111".

Since User 1 is only allowed to operate class A objects, [Class A Button] object appears for operating. [LW-9222] bit 0 turns to "1" means that user can operate class A objects.

User name : LW9219

Password : LW9220

Current status : LW9222
bit 15 bit 0

LB9050

Enter User 3 password "333".

Since User 3 is allowed to operate class A, B, C objects, [LW-9222] bit 0 ~ bit 2 turns to "1", means that user can operate class A ~ C objects.

User name : LW9219

Password : LW9220

Current status : LW9222
bit 15 bit 0

LB9050

Click [Logout] button to log out, the system will return to the initial state, and current user can only operate class "None" objects.

 Note

- Password input: If the password is incorrect, [LB-9060] will be ON; if the password is correct, [LB-9060] will be OFF. All user passwords (User 1 to User 12) can be obtained from system registers [LW-9500] ~ [LW-9522], 24 words in total.
- Changing password directly on HMI: When [LB-9061] is set ON, the system will read data in [LW-9500] ~ [LW-9522] to update user password. The new password will be used in future operations. Please note that the user operable object classes will not be changed due to the change of password.

10.7. Protecting Password Settings from Unauthorized Editing

Before sending the project to others who may edit the project afterwards, it is recommended to click [Editable] button in Security settings tab to open read-only mode. This mode can protect password settings from unauthorized editing.

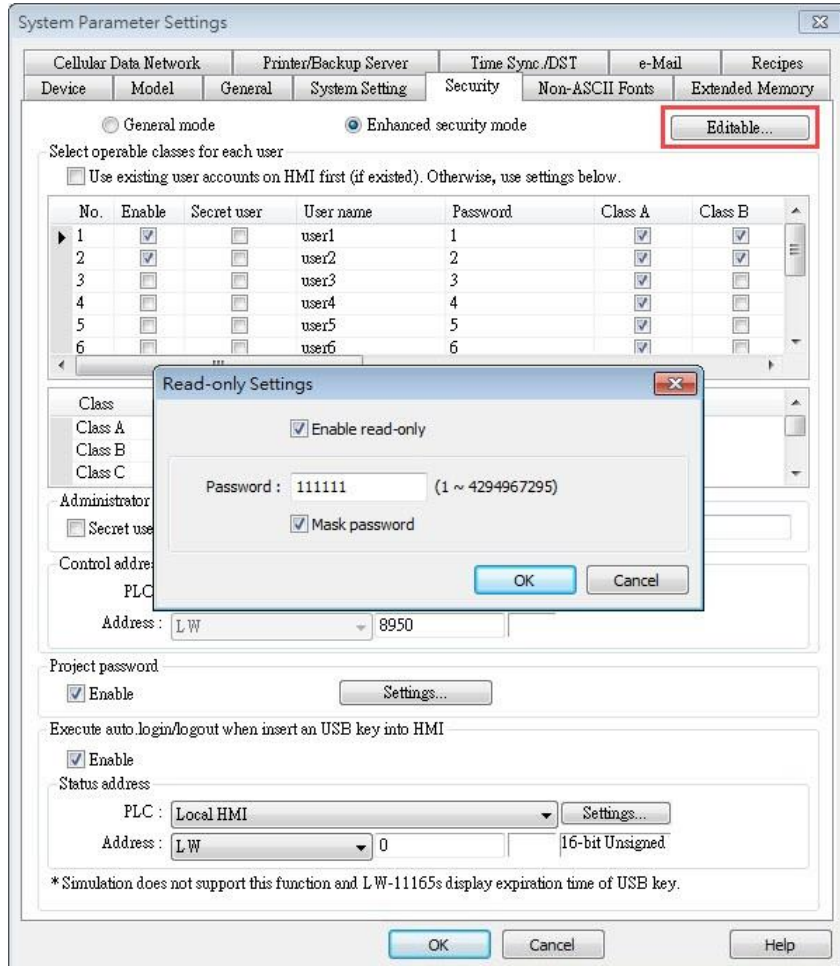

When [Enable read-only] is selected, a password will be required for changing security settings in the project.

When [Mask password] is selected, passwords will be masked by asterisks (*).

Note

- The protected projects cannot be decrypted since they are encrypted by users, therefore, please remember your password.

11. Index Register

This chapter explains how to use Index Register.

11.1. Overview.....	11-2
11.2. Examples of Index Register	11-2

11.1. Overview

EasyBuilder Pro provides Index Registers for changing addresses flexibly. With Index Registers, user can change the object's read/write address directly on HMI without changing its settings. There are 32 Index Registers, divided into 16-bit and 32-bit.

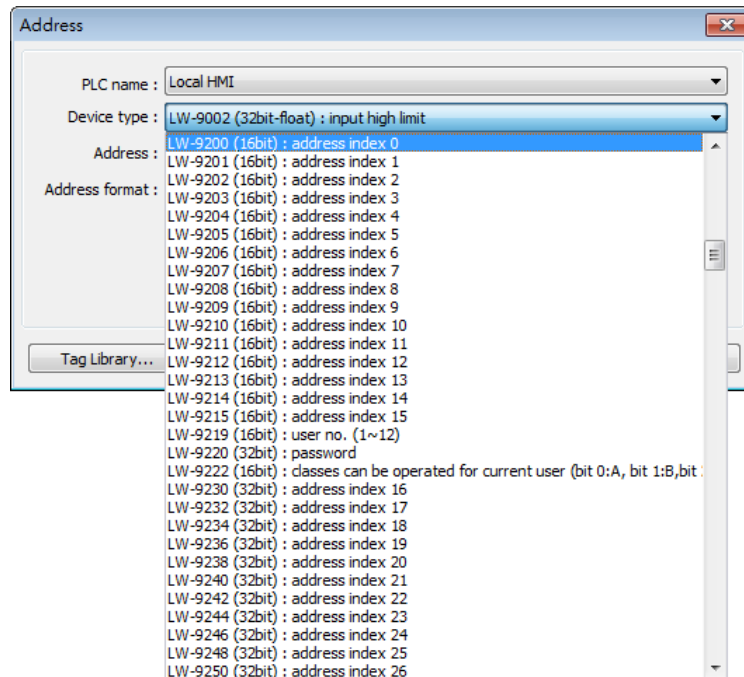

The corresponding address of 16-bit Index Register 0 to 15: LW-9200 (16bit) to LW-9215 (16bit)

The maximum offset range is 65536 words.

The corresponding address of 32-bit Index Register 16 to 31: LW-9230 (32bit) to LW-9260 (32bit)

The maximum offset range is 4294967296 words.

When using [Index register], the address is designated by the following equation:

The constant set in [Address] + the value in the chosen Index Register.

Note

- Index Registers work for the **Word** registers. For **Bit** registers, adding 1 to the value in the Index Register, the offset is 16 bits.

11.2. Examples of Index Register

The following explains the way to designate the register while Index Register is used.

If **not** selecting [**Index register**] check box and set address to [LW-10]. The system will directly

read / write LW-10.

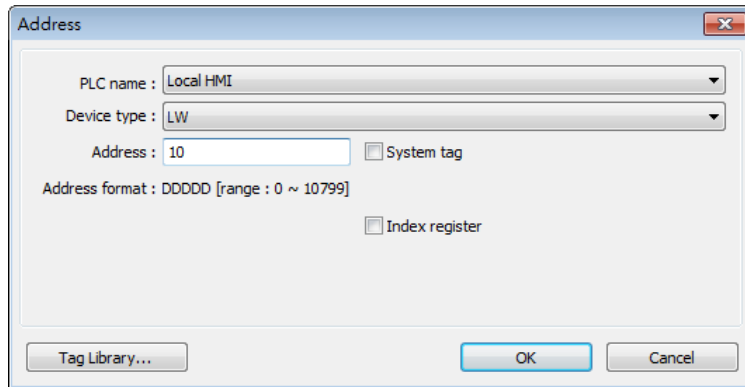

If select **[Index register]** check box and set [Index] to [INDEX 0 (16-bit)]. The system will read / write [LW(10 + value in Index Register)].

If the data in [LW-9200] is "5", the designated address is [LW(10+5)] = [LW-15].

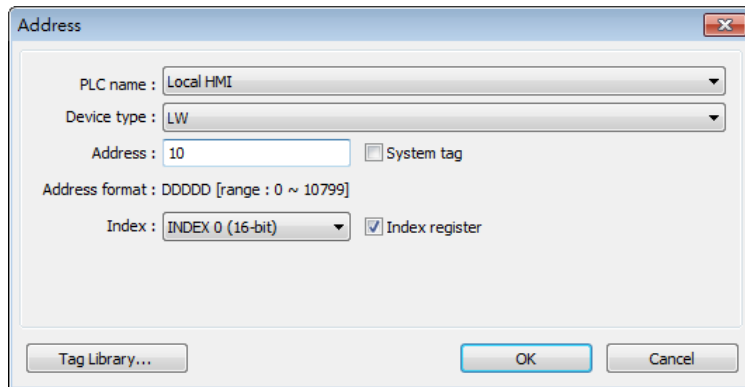

Here's a demo project shown as an example:

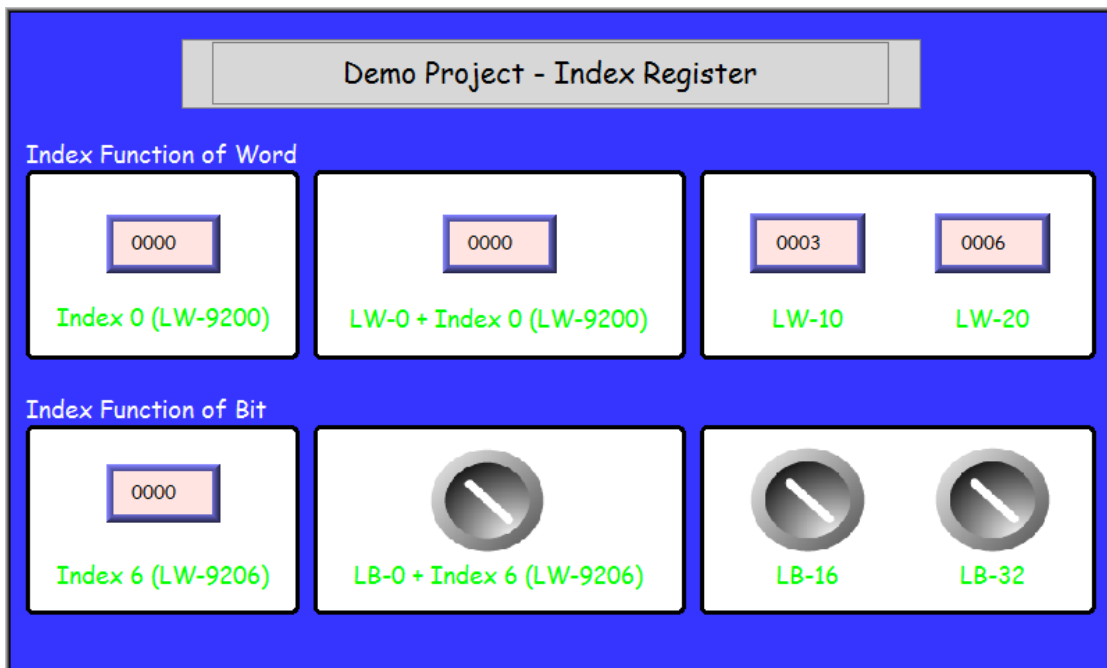

Example 1

The following shows an example of using a Word register and select [Index register]. If the value in [LW-0] is 0, in [LW-10] is 3, and in [LW-20] is 6, the result is:

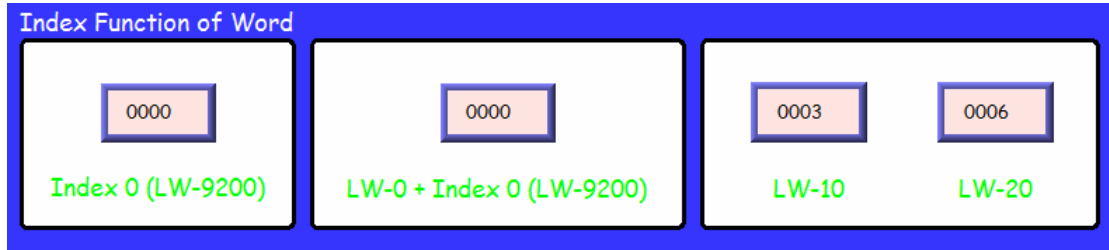

If the value in Index 0 (LW-9200) is 0, then $[LW0 + \text{Index } 0] = \text{read } [LW-0]$.

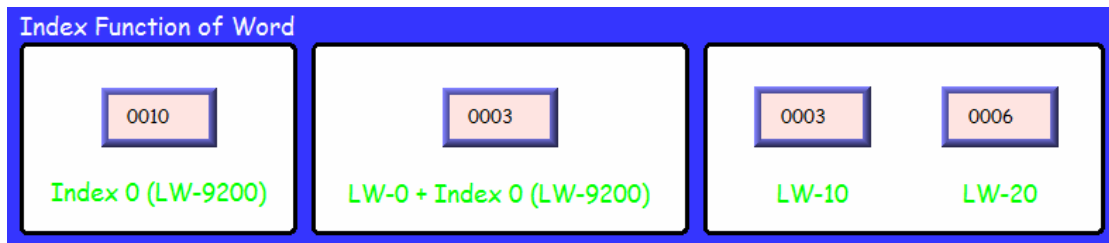

If the value in Index 0 (LW-9200) is 10, then $[LW0 + \text{Index } 0] = \text{read } [LW-10] = 3$.

Example 2

The following shows an example of using a Bit register and select [Index register].

If the state of [LB-16] is ON, and the state of [LB-32] is OFF.

Since 1 Word = 16 Bit, adding 1 in Index Register, the offset is 16 bits.



If Index 6 (LW-9206) is set to 1, then switch $[LB-0 + \text{Index}6]$ reads LB-16 which is in ON state.



If Index 6 (LW-9206) is set to 2, then switch $[LB-0 + \text{Index}6]$ reads LB-32 which is in OFF state.

 **Note**

- When using Index Registers for Bit register, the offset is 16 bits. For example, if the Bit register is LB-0, and set the value in Index Register to 1, then LB-16 will be activated. If set the value in Index Register to 2, then LB-32 will be activated.



Click the icon to download the demo project. Please confirm your internet connection.

12. Keyboard Design and Usage

This chapter explains how to design and use keyboard in EasyBuilder Pro.

12.1. Overview.....	12-2
12.2. Steps to Design a Popup Keyboard.....	12-2
12.3. Steps to Design a Keyboard with Direct Window.....	12-5
12.4. Steps to Design a Fixed Keyboard on Screen.....	12-6
12.5. Steps to Design a UNICODE Keyboard.....	12-7

12.1. Overview

Numeric Input and ASCII Input objects need keyboard as an input tool. Both numeric keyboard and ASCII keyboard are created with Function Key object. Apart from the keyboards provided by EasyBuilder Pro, you can create the keyboard if needed.

The types of the keyboards are:

- Popup Keyboard (with or without title bar)
- Fixed Keyboard
- UNICODE Keyboard

Note

- cMT Series uses the built-in keyboard of iPad which cannot be customized. Please skip this chapter if cMT Series is used.

12.2. Steps to Design a Popup Keyboard

1. Create and open a window for the new keyboard. For example, set to “window no. 200”.

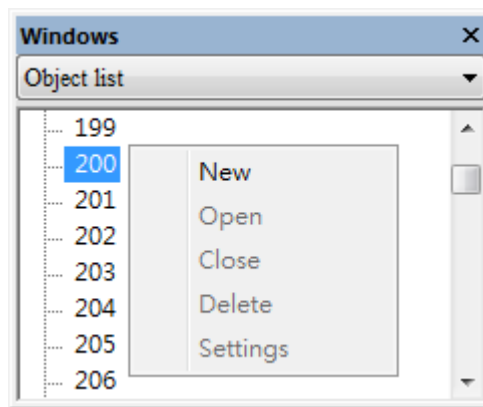

2. Adjust the height and width of “window no. 200” and create a variety of Function Key objects in [ASCII/UNICODE mode].



Set one of the Function Key objects as the [Esc] key.

ASCII/UNICODE mode

[Enter] [Backspace] [Clear] [Esc]

[Delete] [Left] [Right]

[ASCII] / [UNICODE]

Set another Function Key object as the [Enter] key.

ASCII/UNICODE mode

[Enter] [Backspace] [Clear] [Esc]

[Delete] [Left] [Right]

[ASCII] / [UNICODE]

The rest are mostly used to enter numbers.

ASCII/UNICODE mode

[Enter] [Backspace] [Clear] [Esc]

[Delete] [Left] [Right]

[ASCII] / [UNICODE]

3. Select a suitable picture for each Function Key object and place a picture object at the bottom layer as a background.



4. Select [System Parameter Settings] » [General] » [Keyboard] » [Add] to add “window no. 200”. Up to 32 keyboards can be added.

Add a keyboard window

Window no. :

OK Cancel

5. After the keyboard window is added, when you create Numerical Input and ASCII Input objects, “200. Keyboard” can be found in [Data Entry] » [Keyboard] » [Window no.]. The

[Popup position] is for designating the display position of the keyboard on the HMI screen. The system divides the screen into 9 areas.

Keyboard

Use a popup keypad
 Hide title bar
 Restart the keypad if input value is out of range

Window no. : 200. Keyboard

Popup position :
{relative to HMI screen}



6. Select "200.Keyboard". When you press Numerical Input or ASCII Input objects on the screen, "window no. 200" will pop up. You can press the keys on the keyboard to enter data.

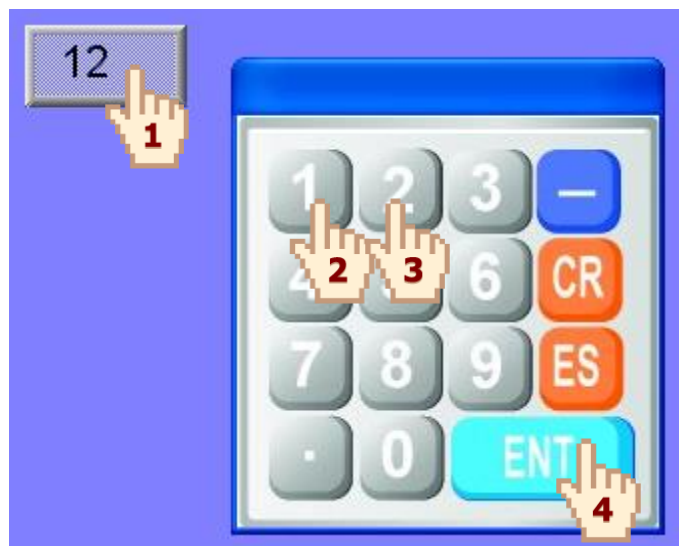

12.3. Steps to Design a Keyboard with Direct Window

1. Create a Direct Window object and set a read address to activate it.
In [General] » [Attribute] select [No title bar] and the correct [Window No.].

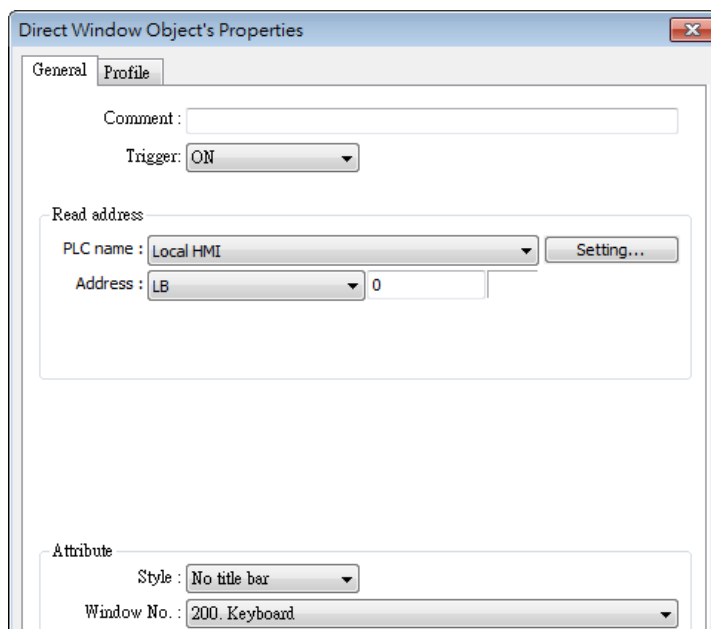

2. Open the [Profile] tab to set the same size as the created keyboard window.

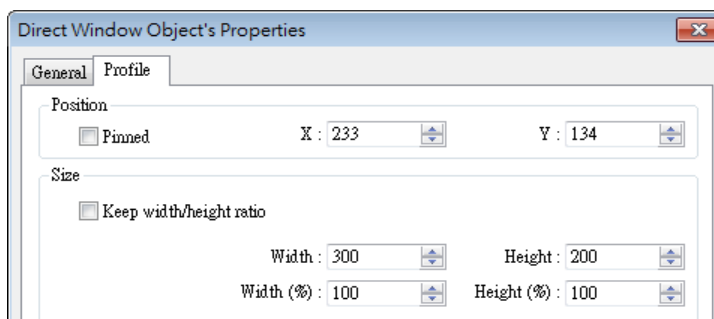

3. Create a Numeric Input object, and don't select [Use a popup keypad] check box.

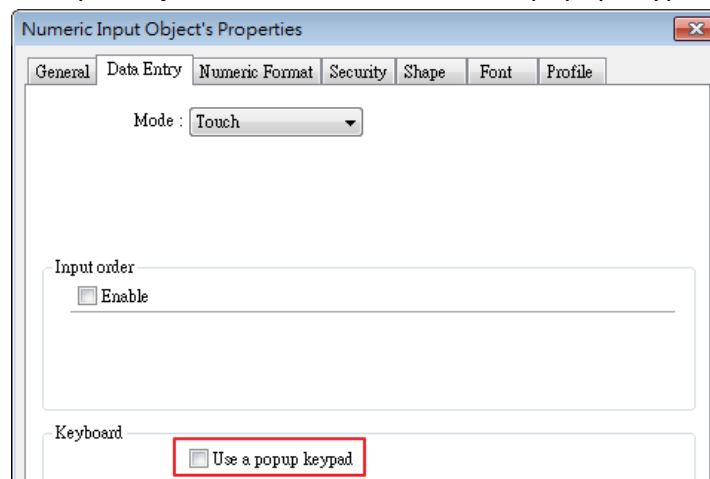

4. Create a Set Bit object, set address to [LB-0] and set [Set style] to [Set ON]. Overlay it on the Numeric Input object. Pressing the Numeric Input object will open the keyboard window.

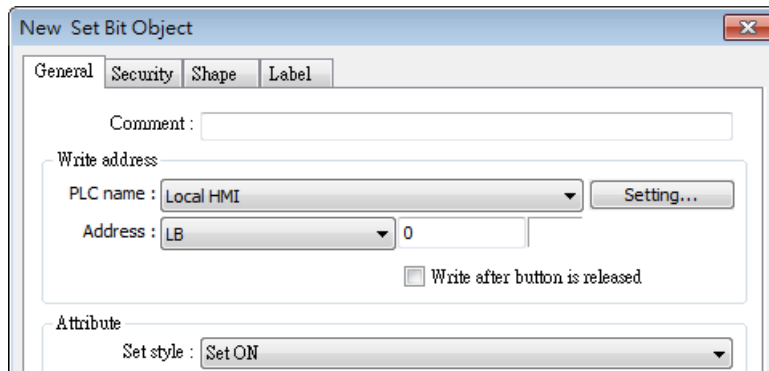

5. Add Set Bit objects on the [Enter] and [ESC] Function Key objects respectively. Set address to [LB-0] and [Set style] to [Set OFF]. In this way when pressing either [Enter] or [ESC] key will close the keyboard window.

12.4. Steps to Design a Fixed Keyboard on Screen

You can also place a fixed keyboard on the screen instead of popup keyboard or Direct Window. This type of keyboard can't be moved or closed.

1. Create a Numeric Input object, in [Data Entry] » [Keyboard] don't select [Use a popup keypad] check box.
2. Use Function Key objects to design the keyboard and place it on the screen.
3. Press the Numeric Input object and enter a value with Function Key objects directly.

12.5. Steps to Design a UNICODE Keyboard

The following steps explain how to create a UNICODE keyboard with Function Key objects.

1. Place an ASCII Input object on the window and select [Use UNICODE] check box.
2. Create Function Key objects as shown in the following figure, and an [Enter] key. A simple UNICODE keyboard is created.

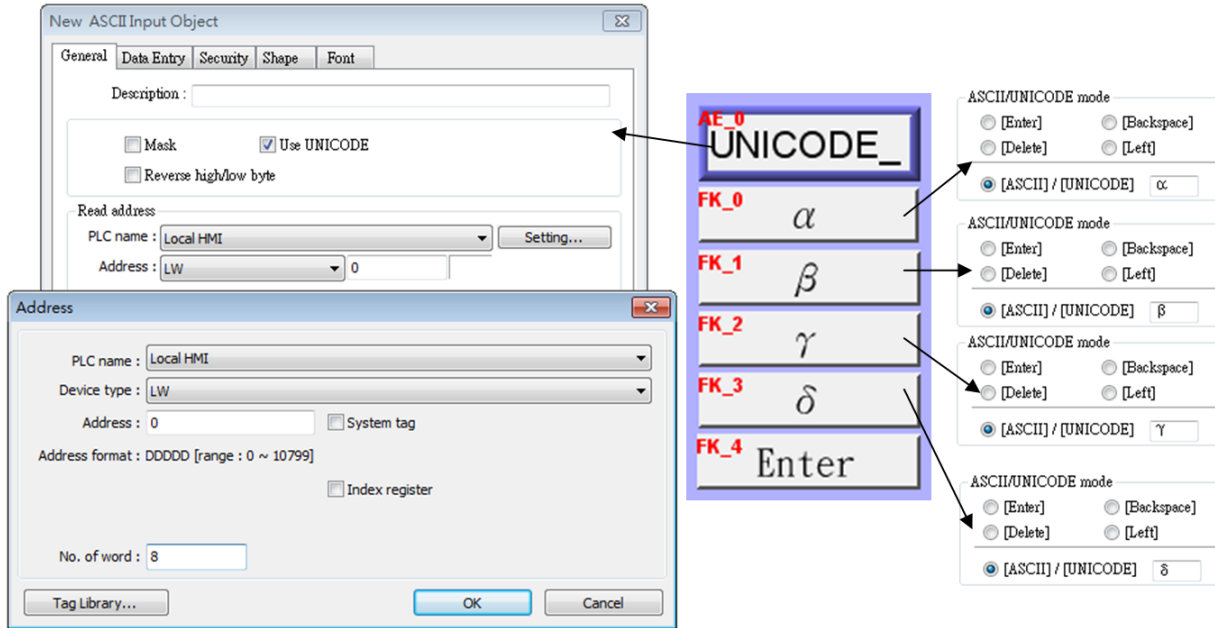

Note

- You can group up the elements of the designed keyboard and save to Group Library for future use.

13. Objects

This chapter explains how to use different objects.

13.1. Bit Lamp	13-3
13.2. Word Lamp	13-5
13.3. Set Bit.....	13-10
13.4. Set Word	13-12
13.5. Function Key	13-20
13.6. Toggle Switch	13-25
13.7. Multi-State Switch	13-27
13.8. Slider	13-31
13.9. Numeric	13-38
13.10. ASCII.....	13-53
13.11. Indirect Window	13-56
13.12. Direct Window	13-60
13.13. Moving Shape	13-64
13.14. Animation	13-68
13.15. Bar Graph.....	13-72
13.16. Meter Display.....	13-80
13.17. Trend Display	13-88
13.18. History Data Display.....	13-101
13.19. Data Block Display	13-107
13.20. XY Plot.....	13-115
13.21. Alarm Bar and Alarm Display.....	13-121
13.22. Event Display.....	13-127
13.23. Data Transfer (Trigger-based)	13-136
13.24. Backup	13-138
13.25. Media Player.....	13-145
13.26. Data Transfer.....	13-151
13.27. PLC Control	13-155
13.28. Scheduler	13-162
13.29. Option List.....	13-171
13.30. Timer.....	13-179
13.31. Video In.....	13-183
13.32. System Message	13-189

13.33. Recipe View	13-191
13.34. Flow Block.....	13-197
13.35. Operation Log	13-201
13.36. Combo Button.....	13-213
13.37. Circular Trend Display	13-216
13.38. Picture View.....	13-225
13.39. File Browser	13-228
13.40. Import/Export.....	13-231
13.41. Pie Chart	13-235
13.42. 2D Barcode Display.....	13-240
13.43. String Table	13-242
13.44. Database Server.....	13-244
13.45. Dynamic Scale.....	13-248
13.46. Dynamic Drawing.....	13-251
13.47. PDF Reader	13-256
13.48. Table.....	13-258
13.49. VNC Viewer	13-260
13.50. Barcode Scanner (Android Camera)	13-264
13.51. Contacts Editor	13-270

13.1. Bit Lamp

13.1.1. Overview

Bit Lamp object displays the state of a designated bit address. If the bit state is OFF, the State 0 shape will be displayed. If the bit state is ON, the State 1 shape will be displayed.



13.1.2. Configuration



Click the Bit Lamp icon on the toolbar to open a Bit Lamp object property dialog box. Set up the properties, press OK button, and a new Bit Lamp object will be created.

General Tab

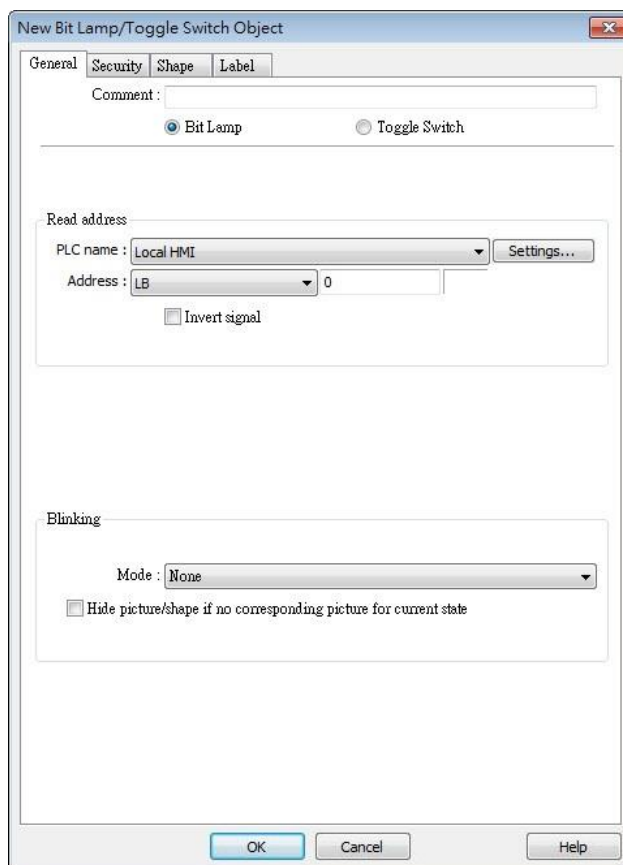

The dialog box is titled "New Bit Lamp/Toggle Switch Object" and has four tabs: General, Security, Shape, and Label. The General tab is active. It contains the following fields and controls:

- Comment: A text input field.
- Radio buttons: "Bit Lamp" (selected) and "Toggle Switch".
- Read address section:
 - PLC name: A dropdown menu showing "Local HMI" and a "Settings..." button.
 - Address: A dropdown menu showing "LB" and a text input field containing "0".
 - Invert signal
- Blinking section:
 - Mode: A dropdown menu showing "None".
 - Hide picture/shape if no corresponding picture for current state

At the bottom of the dialog are three buttons: "OK", "Cancel", and "Help".

Setting	Description
Comment	User can describe the information of the object. Bit Lamp / Toggle Switch Switch between Bit Lamp and Toggle Switch features.
Read address	Click [Setting] to select the [PLC name], [Address], [Device type], [System tag], [Index register] of the bit device that controls the [Bit Lamp] object. Users can also set address in [General] tab while adding a new object. Invert signal Reverses the display of ON / OFF states. For example, if [Invert signal] check box is selected, when the designated bit is OFF, the object displays ON state.
Blinking	The appearance of the object may alternate between states when the bit is ON or OFF. Mode: None No blinking. Alternating image on state 0 The appearance of the object alternates between State 0 and 1 when the bit is OFF. Alternating image on state 1 The appearance of the object alternates between State 0 and 1 when the bit is ON. Blinking on state 0 The State 0 appearance of the object will blink when the bit is OFF. Blinking on state 1 The State 1 appearance of the object will blink when the bit is ON. Hide picture/shape if no corresponding picture for current state If selected, when there are not enough pictures to represent all the states, hides the picture. Otherwise, displays the last state.

Note

- In [Label] tab, if select [ON=OFF (use state 0)] check box, both state 0 and 1 follow the settings of state 0.

13.2. Word Lamp

13.2.1. Overview

Word Lamp object displays the state according to the value of a designated word register. Up to 256 states are available. When the value of the register is 0, State 0 appearance of the object is displayed, and with the register value being 1 the object displays State 1, and so on.

Numeric Display (LW0) Word Lamp (LW0)

0

State 0

Numeric Display (LW0) Word Lamp (LW0)

1

State 1

Numeric Display (LW0) Word Lamp (LW0)

2

State 2

13.2.2. Configuration



Click the Word Lamp icon on the toolbar to open a Word Lamp object property dialog box. Set up the properties, press OK button, and a new Word Lamp object will be created.

General Tab

Setting	Description
Comment	User can describe the information of the object. Word Lamp / Multi-State Switch
	Switch between Word Lamp and Multi-State Switch features.
Mode / Offset	Word Lamp object offers the following three modes: Value The state is displayed according to the value in the designated word address and plus the [Offset]. As shown below, if the value within LW-200 is 3, since the offset is set to 3, the shape of state 0 is displayed. (value 3 - offset 3)

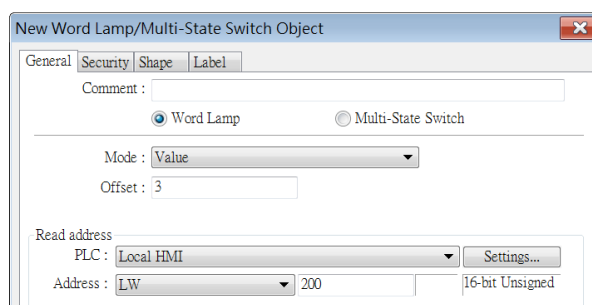

LSB

Convert the value from decimal to binary. The least significant active bit in a binary data word selects the state displayed.

Decimal	Binary	Displayed state
0	0000	State 0 displayed. All the bits are 0.
1	0001	State 1 displayed. The least significant active bit is bit 0.
2	0010	State 2 displayed. The least significant active bit is bit 1.
3	0011	State 1 displayed. The least significant active bit is bit 0.
4	0100	State 3 displayed. The least significant active bit is bit 2.
5	0101	State 1 displayed. The least significant active bit is bit 0.
6	0110	State 2 displayed. The least significant active bit is bit 1.
7	0111	State 1 displayed. The least significant active bit is bit 0.
8	1000	State 4 displayed. The least significant active bit is bit 3.

Bit combination

Lamp state depends on the states of bit combinations, where PLC 1 represents the least significant bit (LSB), PLC 2 represents the next LSB, and so on. Maximum number of bit is 4, for a total of 16 states. Changing [No. of states] in Attribute group box changes the number of read addresses.

Word Lamp Multi-State Switch

Mode:

Read address

PLC 1:

Address 1:

PLC 2:

Address 2:

PLC 3:

Address 3:

PLC 4:

Address 4:

Attribute

No. of states:

Change state by time

The state displayed changes on a time basis. The frequency can be set.

Read address

Click [Setting] to select the [PLC name], [Address], [Device type], [System tag], [Index register] of the word device that controls the [Word Lamp] object. Users can also set address in [General] tab while adding a new object.

Attribute

No. of states

The number of states is utilized by the object. The state is numbered from 0, so the number of states minus 1 will be the state number. If the value within the word register is \geq [No. of states] defined in Attribute, the highest state will be displayed.

If the number of states is set to 8, the valid states will be 0, 1, 2, ..., 7. In this case if the word value is 8 or higher, the system will display the state 7 shape.

Hide picture/shape if no corresponding picture for current state

If selected, when there are not enough pictures to represent all the states, hides the picture. Otherwise, displays the last state.

Note

- In [Label] tab, Language 1 determines the relevant settings of the font. For Language 2~8, only the font size can be changed and other settings follow Language 1.

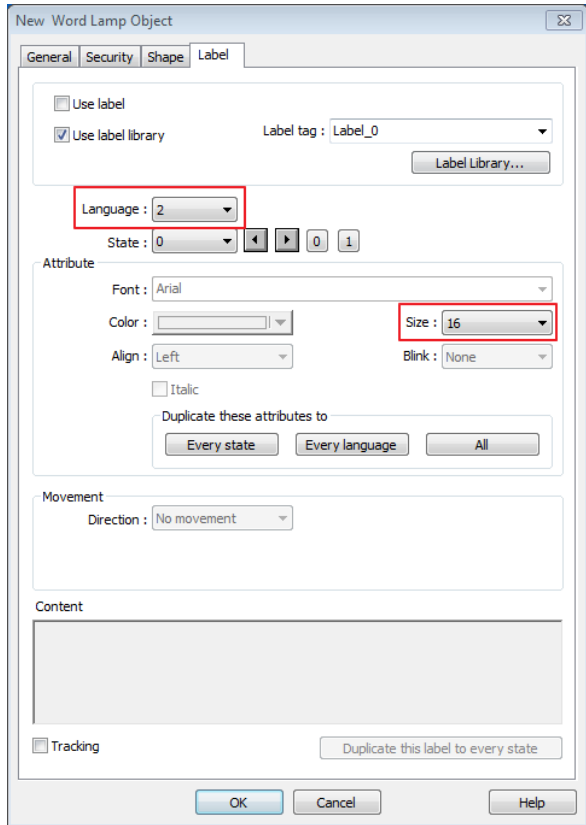
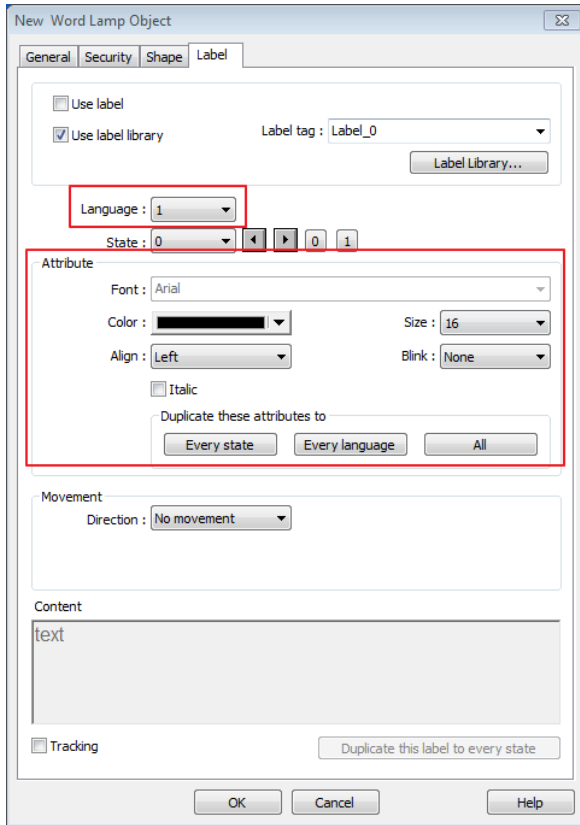

13.3. Set Bit

13.3.1. Overview

The Set Bit object provides two operation modes: manual or automatic. Manual mode can trigger a designated bit address to change the state between ON and OFF when the object is touched. In automatic mode, the bit is automatically activated when a pre-defined condition occurs; touching the button will not be effective.

13.3.2. Configuration

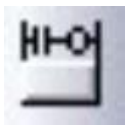

Click the Set Bit icon on the toolbar to open a Set Bit object property dialog box. Set up the properties, press OK button, and a new Set Bit object will be created.

General Tab

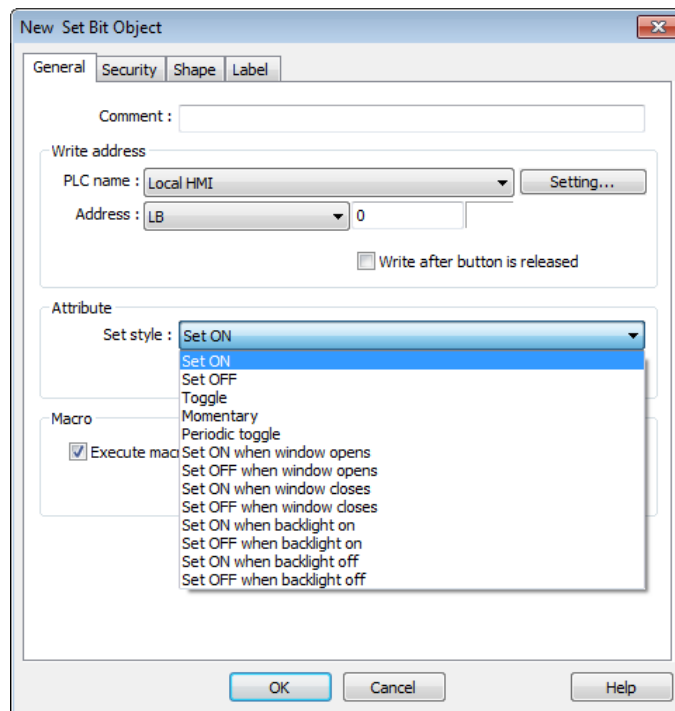

Setting	Description
Write address	Click [Setting] to select the [PLC name], [Address], [Device type], [System tag], [Index register] of the bit device that controls the Set Bit object. Users can also set address in [General] tab while adding a new object.

Write after button is released

If this function is selected, the action is delayed till button is released; otherwise, the action is executed once the button is pressed. This function does not work with momentary buttons.

Mode / Offset	Set style	Description
	Set ON	Set ON the designated bit of the device.
	Set OFF	Set OFF the designated bit of the device.
	Toggle	Alternates the bit state each time pressed.
	Momentary	Holds the bit ON only while button is pressed.
	Periodical toggle	Set a designated bit ON and OFF at a set time interval. Time interval can be selected; the range is from 0.1 to 25.5 seconds.
	Set ON when window opens	Set ON the bit within the window when the window opens.
	Set OFF when window opens	Set OFF the bit within the window when the window opens.
	Set ON when window closes	Set ON the bit within the window when the window closes.
	Set OFF when window closes	Set OFF the bit within the window when the window closes.
	Set ON when backlight on (N/A for cMT)	Set the bit ON when the backlight is turned ON.
	Set OFF when backlight on (N/A for cMT)	Set the bit OFF when the backlight is turned ON.
	Set ON when backlight off (N/A for cMT)	Set the bit ON when the backlight is turned OFF.
	Set OFF when backlight off (N/A for cMT)	Set the bit OFF when the backlight is turned OFF.

Macro

Set Bit object can trigger the start of a Macro routine when the Macro has been created in advance.



For more information, see "18 Macro References".

Trigger mode

If [Set style] is set to [Toggle], there is a further selection to make of whether the macro operates after Off to ON, ON to OFF transition, or at both of the changes of state.

Note

- In [Label] tab, if select [ON=OFF (use state 0)] check box, both state 0 and 1 follow the settings of state 0.
- Using address types other than PLB or PLW_Bit for Set Bit objects with [Periodic Toggle] attribute is not supported by cMT-SVR.

13.4. Set Word

13.4.1. Overview

The Set Word object provides two operation modes: manual or automatic. Manual mode can change the value in a designated word address when the object is touched. In automatic mode, the word register is automatically activated when a pre-defined condition occurs; touching the button will not be effective.

13.4.2. Configuration



Click the Set Word icon on the toolbar to open a Set Word object property dialog box. Set up the properties, press OK button, and a new Set Word object will be created.

General Tab

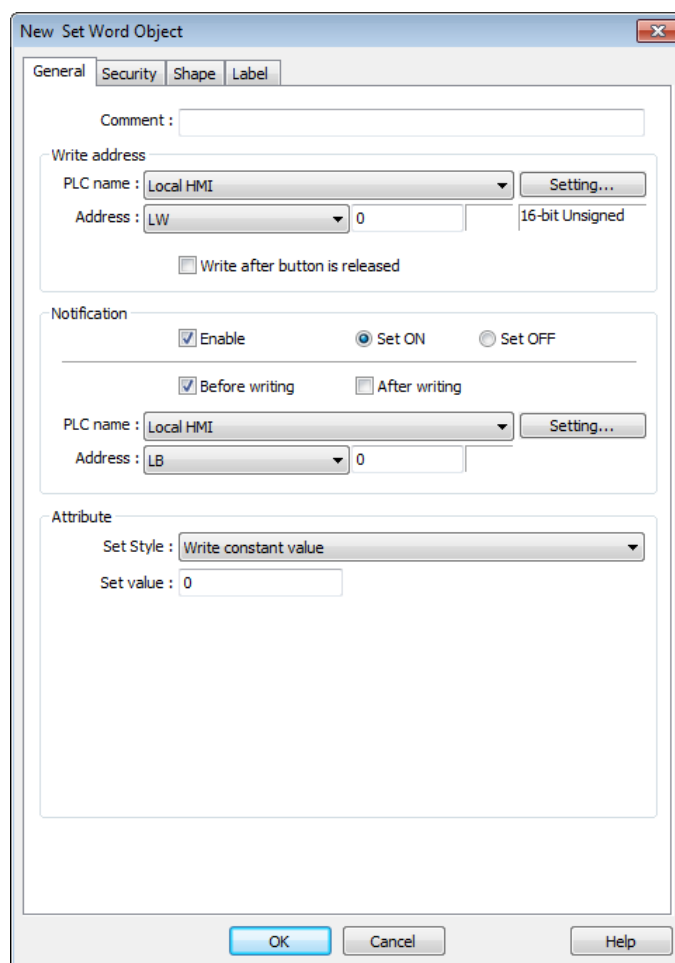

The screenshot shows the 'New Set Word Object' dialog box with the 'General' tab selected. The dialog has four tabs: General, Security, Shape, and Label. The 'General' tab contains the following fields and options:

- Comment:** A text input field.
- Write address:**
 - PLC name: Local HMI (dropdown menu)
 - Address: LW (dropdown menu) 0 (text input)
 - 16-bit Unsigned (checkbox)
 - Write after button is released (checkbox)
- Notification:**
 - Enable (checked checkbox)
 - Set ON (selected radio button), Set OFF (radio button)
 - Before writing (checked checkbox), After writing (checkbox)
 - PLC name: Local HMI (dropdown menu)
 - Address: LB (dropdown menu) 0 (text input)
- Attribute:**
 - Set Style: Write constant value (dropdown menu)
 - Set value: 0 (text input)

At the bottom of the dialog are three buttons: OK, Cancel, and Help.

Setting	Description
Write address	Click [Setting] to select the [PLC name], [Address], [Device type], [System tag], [Index register] of the word device that controls the Set Word object. Users can also set address in [General] tab while adding a new object. Write after button is released If this function is selected, the action is delayed till button is released; otherwise, the action is executed once the button is pressed.
Notification	If this check box is selected, it will notify a designated bit address (setting ON or OFF). Before writing / After writing Set the state of the designated bit address before or after the manual operation.
Attribute	Set Style Select the button action from the drop down list, see Example 2. Dynamic limits Set the [Bottom limit] and [Upper limit] by a designated register, see Example 1.

Example 1

Set the [Bottom limit] and [Upper limit] by a designated register. When Dynamic Address is LW-n, where n is an arbitrary number, the rule of setting Upper / Bottom limit is:

Content	16-bit	32-bit
Dynamic address	LW-n	LW-n
Bottom limit	LW-n	LW-n
Upper limit	LW-n+1	LW-n+2

When Dynamic Address is LW-100, the rule of setting Upper / Bottom limit is:

Content	16-bit	32-bit
Dynamic address	LW-100	LW-100
Bottom limit	LW-100	LW-100
Upper limit	LW-101	LW-102

Example 2

The available button actions are:

- Write constant value

Preset a register with the value entered. Each time when the button is pressed, it writes the [Set value] to the designated register. Data format is as set by the [Write address]; it can be 16-bit BCD, 32-bit BCD, ...32-bit float. As shown below, when the button is pressed, preset the register with 12.

Attribute

Set Style : Write constant value

Set value : 12

- Increment value (JOG+)

Increase value in register by a set amount in [Inc. value], each time when the button is pressed, up to the [Upper limit]. As shown below, each button press increases the value in the register by 1 until the value is 10.

Attribute

Set Style : Increment value (JOG+)

Inc. value : 1 Upper limit : 10

- Decrement Value (JOG-)

Decrease value in register by a set amount in [Dec. value], each time when the button is pressed, down to the [Bottom limit]. As shown below, each button press decreases the value in the register by 1 until the value is 0.

Attribute

Set Style : Decrement value (JOG-)

Dec. value : 1 Bottom limit : 0

- Press and hold increment (JOG++)

When the button is held longer than a set time in [JOG delay], it will increase the value in a register by a set amount :[Inc. value] at a set rate :[JOG speed], to the [Upper limit]. As shown below, when the button is pressed, it increases the value in the designated register by 1. When the button is held longer than 1 second, it increases the value in register by 1 every 0.5 second, till the value is 10.

Attribute

Set Style : Press and hold increment (JOG++)

Inc. value : 1 Upper limit : 10

JOG delay : 1.0 second(s) JOG speed : 0.5 second(s)

- Press and hold increment (JOG--)

When the button is held longer than a set time in [JOG delay], it will decrease the value in a register by a set amount: [Dec. value] at a set rate: [JOG speed], to the [Bottom limit]. As shown below, when the button is pressed, it decreases the value in the designated register by 1. When the button is held longer than 1 second, it decreases the value in register by 1 every 0.5 second, till the value is 0.

Attribute

Set Style :

Dec. value : Bottom limit :

JOG delay : JOG speed :

- Periodic JOG++

This automatic function increases the value in the register by a set amount: [Inc. value], at a set rate: [Time interval], to the [Upper limit]. As shown below, the system will automatically increase the value in the register by 1 every 0.5 second, till the value is 10. Then the value returns to 0 and add 1 every 0.5 second again.

Attribute

Set Style :

Inc. value : Upper limit :

Time interval :

- Automatic JOG++

This automatic function increases the value in the register by a set amount: [Inc. value], at a set rate: [Time interval], to the [Upper limit].then holds this value. As shown below, the system will automatically increase the value in the register by 1 every 0.5 second, till the value is 10, and then stop.

Attribute

Set Style :

Inc. value : Upper limit :

Time interval :

- Automatic JOG--

This automatic function decreases the value in the register by a set amount: [Dec. value], at a set rate: [Time interval], to the [Bottom limit].then holds this value. As shown below, the system will automatically increase the value in the register by 1 every 0.5 second, till the value is 10, and then stop.

Attribute

Set Style : Automatic JOG-- (down to low limit) ▼

Dec. value : 1 Bottom limit : 10

Time interval : 0.5 second(s) ▼

- Periodic bounce

Increases the word address value to the [Upper limit] by a [Inc. value] at a set rate in [Time interval], then decreases to the [Bottom limit] by the same value at the same rate. As shown below, the system will increase the value in the designated register by 1 every 0.5 second, till the value is 10, and then decrease the value by 1 every 0.5 second till the value is 0 whenever the screen is active.

Attribute

Set Style : Periodic bounce (up->down->up->...) ▼

Bottom limit : 0 Upper limit : 10

Inc. value : 1

Time interval : 0.5 second(s) ▼

- Periodic step up

Step up to the [High limit] by [Inc. value] at a set rate in [Time interval], then reset immediately to the [Low limit]. The action repeats whenever the screen is active. As shown below, the system will increase the value in the designated register by 1 every 0.5 second, till the value is 10, and then reset to 0 and increase again, and the action repeats.

Attribute

Set Style : Periodic step up (low to high...) ▼

Low limit : 0 High limit : 10

Inc. value : 1

Time interval : 0.5 second(s) ▼

- Periodic step down

Step down to the [Low limit] by [Dec. value] at a set rate in [Time interval], then reset immediately to the [High limit]. The action repeats whenever the screen is active. As shown below, the system will decrease the value in the designated register by 1 every 0.5 second, till the value is 0, and then reset to 10 and decrease again, and the action repeats.

Attribute

Set Style : Periodic step down (high to low...)

Low limit : 0 High limit : 10

Dec. value : 1

Time interval : 0.5 second(s)

- Set when window opens / Set when window closes

Automatic function occurs whenever the screen is active. The value entered in [Set value] is set into the word address when the action occurs. If [Set value] is set to 5, when the window opens / closes, the system enters 5 into the designated register.

- Set when backlight on / Set when backlight off

Automatic function occurs whenever the backlight is active. The value entered in [Set value] is set into the word address when the action occurs. If [Set value] is set to 5, when the backlight turns ON / OFF, the system sets 5 into the designated register.

- Cyclic JOG+

Each time when the button is pressed, increases the word address value to the [Upper limit] by [Inc. value] then reset to the [Bottom limit]. As shown below, each time when pressing the button, the system will increase the value in the designated register by 1, till the value is 10, and then reset to 0 and increase again by pressing the button.

Attribute

Set Style : Cyclic JOG+

Bottom limit : 0 Upper limit : 10

Inc. value : 1

- Cyclic JOG-

Each time when the button is pressed, decrease the word address value to the [Bottom limit] by [Dec. value] then reset to the [Upper limit]. As shown below, each time when pressing the button, the system will decrease the value in the designated register by 1, till the value is 0, and then reset to 10 and decrease again by pressing the button.

Attribute

Set Style : Cyclic JOG-

Bottom limit : 0 Upper limit : 10

Dec. value : 1

- Cyclic JOG++

When the button is held longer than a set time in [JOG delay], it increases the value in a register by a set amount in [Inc. value] at a set rate in [JOG speed], to the [Upper limit], then reset to the [Bottom limit]. As shown below, when the button is held longer than 0.5 second, increase the value in the designated register by 1 every 0.1 second, till the value is 10, and then

reset to 0 and increase again by holding the button.

Attribute

Set Style : **Cyclic JOG++**

Bottom limit : 0 Upper limit : 10

Inc. value : 1

JOG delay : 0.5 second(s) JOG speed : 0.1 second(s)

- Cyclic JOG- -

When the button is held longer than a set time in [JOG delay], decrease the value in a register by a set amount in [Dec. value] at a set rate in [JOG speed], to the [Bottom limit], then reset to the [Upper limit]. As shown below, when the button is held longer than 0.5 second, decrease the value in the designated register by 1 every 0.1 second, till the value is 0, and then reset to 10 and decrease again by holding the button.

Attribute

Set Style : **Cyclic JOG--**

Bottom limit : 0 Upper limit : 10

Dec. value : 1

JOG delay : 0.5 second(s) JOG speed : 0.1 second(s)

Security Tab

Set Word Object's Properties

General Security Shape Label Profile

Safety control

Min. press time (sec) : 0

Display confirmation request Max. waiting time (sec) : 10

Interlock

Use interlock function Bit Word

Hide when disabled

Grayed label when disabled

Trigger if value is : > 1

PLC : Local HMI Settings...

Address : LW 1 16-bit Unsigned

User restriction

Object class : None

Setting	Description
Interlock	<p>Use interlock function</p> <p>When this option is enabled and [Word] is selected, whether the object is operable depends on the condition of a word address specified in [Trigger if value is:]. In the settings above, the object is operable only when the value in LW-1 is greater than 1.</p> <p>Hide when disabled</p> <p>The object is hidden when the specified condition does not occur in the specified word address.</p> <p>Grayed label when disabled</p> <p>The label of the object turns gray when the specified condition does not occur in the specified word address.</p> <div style="border: 1px solid gray; padding: 2px; display: inline-block; margin: 5px 0;">button</div> <p>Trigger if value is:</p> <p>This setting is for specifying a trigger condition. The available options are: >, <, ==, <>, >=, and <=. A tolerance value can be set for conditions == and <>.</p> <p>For example:</p> <div style="margin-left: 20px;"> <input checked="" type="checkbox"/> Hide when disabled <input type="checkbox"/> Grayed label when disabled Trigger if value is : == <input type="text" value="10"/> Tolerance : <input type="text" value="1"/> </div> <p>When the value is the specified word address is greater than or equal to 11, or smaller than or equal to 9, the object will be hidden and is not operable.</p>

Note

- Using address types other than PLW for Set Word objects with automatic attributes such as [Periodic set up], [Periodic set down], [Automatic JOG++], [Automatic JOG--], and [Periodic JOG++]...etc, is not supported by cMT-SVR.

13.5. Function Key

13.5.1. Overview

The Function Key object can be used for several tasks, such as switching between windows, keypad design, Macro execution, screen hardcopy, and setting USB security key.

13.5.2. Configuration



Click the Function Key icon on the toolbar to open a Function Key object property dialog box. Set up the properties, press OK button, and a new Function Key object will be created.

General Tab

cMT Series

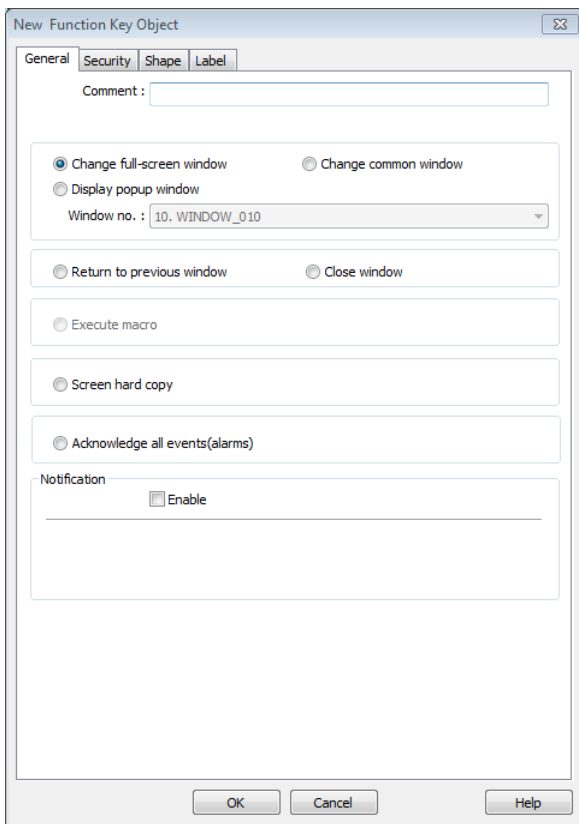

eMT, iE, XE, mTV Series

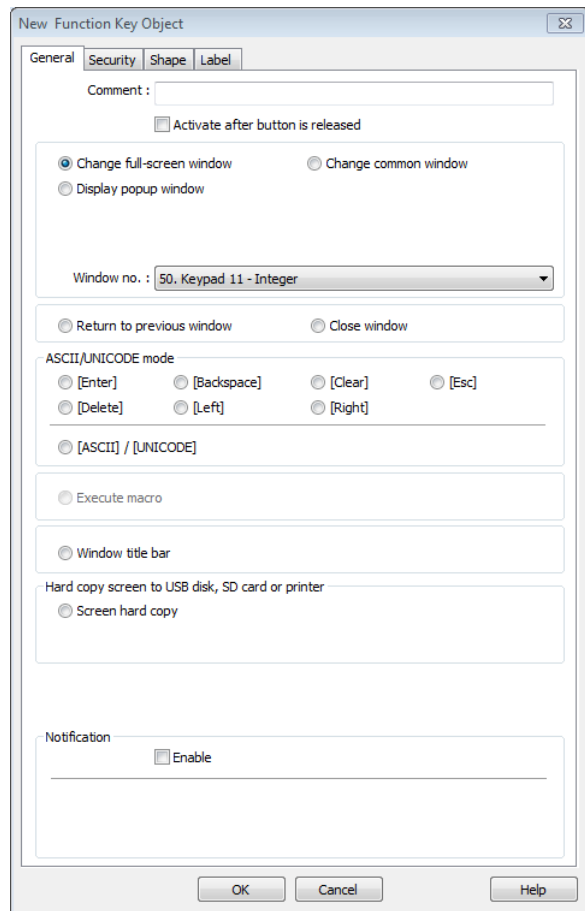

Setting	Description
Activate after button is released	If this function is selected, the action is delayed till button is released; otherwise, the action is executed once the button is pressed.
Change window	<p>Change full-screen window: Change to another base window.</p> <p>Change common window: Change common window.</p> <p>Display popup window: A pop-up window displays in the base window. If [Close this popup window when parent window is closed] check box is selected, the pop up window will be closed when change the base window to another window. Otherwise, a function key in the pop up window is needed to close it.</p>

Display popup window
 Close this popup window when parent window is closed
 Style :
 Window no. :

(cMT Series) Display popup window: cMT Series allows using transition effects for opening popup windows using Function Keys. The settings can be opened by clicking [Animation Setting].

Change full-screen window Change common window
 Display popup window
 Window no. :

[Effect]: The effects are: Fade, Fly, and Float. Different effects may be used for Start (window appears) and End (window disappears).

Animation ✕

	Effect	Duration	Direction
Start :	<input type="text" value="Fade"/>	<input type="text" value="100"/> ms	
End :	<input type="text" value="Fly"/>	<input type="text" value="100"/> ms	<input type="text" value="To Left"/>

[Duration] specifies how many milliseconds (ms) a transition effect takes to complete.

[Direction] The direction of the transition.

Return to previous window: If this is selected, the Function Key will change from the current screen to the previous one displayed. For example, when window no. 10 is changed to window no. 20, press the function key to return to window no. 10. This function is only available for base window.

Close window: Close any active pop-up windows, message windows included.

**ASCII/
UNICODE
mode**

Configures the button as a keypad key, and the character it enters, via [Numeric] or [ASCII] objects.

Enter: Same as the keyboard’s “Enter” function.

Backspace: Same as the keyboard’s “Backspace” function.

Clear: Clear the value in the word register.

Esc: Same as the [Close window] function; it is used to close the keyboard window.

Delete: Same as the keyboard’s “Delete” function, deletes the number or character on the right side of the text cursor.

Left: Same as the keyboard’s “←” key moves the text cursor to the left side of the previous number or character.

Right: Same as the keyboard’s “→” key moves the text cursor to the left side of the next number or character.

ASCII/UNICODE: Specify the character to be entered by this key.

**Execute
Macro**

Select this check box to execute one of the Macros from the drop down list that has already been configured by users.

 For more information, see “18 Macro References”.

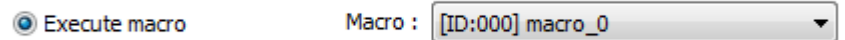

**Window title
bar**

Function Key defined can be used to move a pop-up window which has no [window title bar] to a preferred position on screen. Select the pop-up window and then click on a preferred position, the window will be moved.

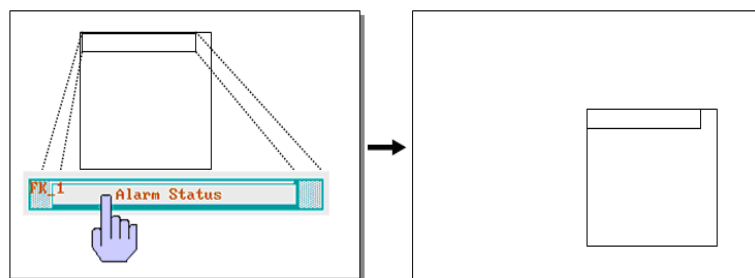

Select the window title bar firstly.

Touching the screen for the new position the popup window will be moved.

**Hard copy
screen to
USB disk, SD
card or
printer**

Print the current window. Before using this function, choose a printer model in [System Parameter Settings] » [Model] » [Printer].

If a monochrome printer is used, selecting [grayscale] can provide a better print result, but the text may not be clearly printed. To

improve text printing, avoid using [grayscale].

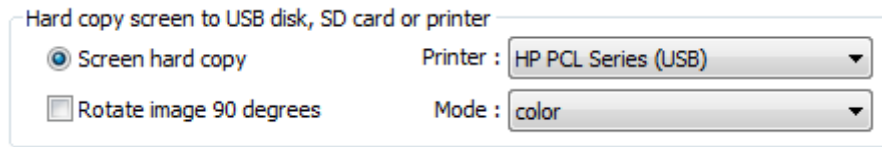

Screen hard copy (cMT Series)

Output current screen to iPad Photos.

Acknowledge all events (alarms) (cMT Series)

Acknowledge all events once by pressing the Function Key.

Import user data / Use [USB Security Key]

A Function Key can be used to import the e-mail contacts or user accounts set, also, to log in using USB Security Key.

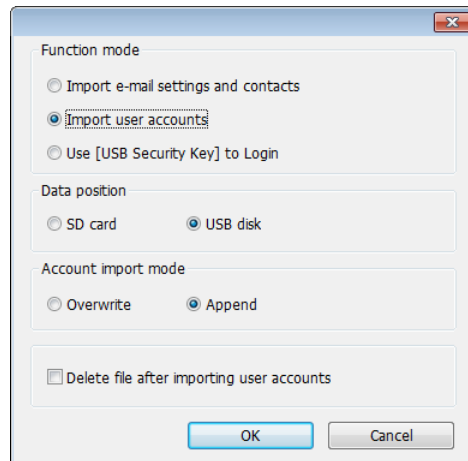

Data Position

Select the external device to store data from [SD card] or [USB disk].

Account import mode

If [Overwrite] is selected, the existing accounts will be overwritten with new accounts in the external device after importing. If [Append] is selected, HMI will append more accounts while the old accounts still exist.

Delete file after importing user accounts

If select this check box, the system will delete the account data saved in the external device after importing, this can prevent the account data from leaking out.

Notification

If this selection is enabled, it will notify a designated bit address to set ON or OFF, each time the button is pressed.

 **Note**

- [Overwrite] is the only option when importing the e-mail contacts. This means that all existing contacts will be removed first, and then the new contacts are added.

 For more information, see “6 Window Operations”, “12 Keypad Design and Usage”, “36 Administrator Tools”.

13.6. Toggle Switch

13.6.1. Overview

Toggle Switch object is a combination of Bit Lamp object and Set Bit object. The appearance of the object is controlled by the ON / OFF state of the read bit address. As well, pressing the button sets the value in the bit address according to the settings.

13.6.2. Configuration



Click the Toggle Switch icon on the toolbar to open a Toggle Switch object property dialog. Set up the properties, press OK button, and a new Toggle Switch object will be created.

General Tab

The screenshot shows the 'New Toggle Switch/Bit Lamp Object' dialog box with the 'General' tab selected. The dialog has four tabs: General, Security, Shape, and Label. The 'General' tab contains the following fields and options:

- Comment:** A text input field.
- Object Type:** Two radio buttons: 'Bit Lamp' (unselected) and 'Toggle Switch' (selected).
- Read/Write use different addresses:** A checkbox (unchecked).
- Read address:**
 - PLC name:** A dropdown menu set to 'Local HMI' with a 'Settings...' button.
 - Address:** A dropdown menu set to 'LB' and a text input field containing '0'.
 - Invert signal:** A checkbox (unchecked).
- Write address:** A text input field.
- Write when button is released:** A checkbox (unchecked).
- Attribute:**
 - Switch style:** A dropdown menu set to 'Set ON'.
- Macro:**
 - Execute macro:** A checkbox (unchecked).

At the bottom of the dialog are three buttons: 'OK', 'Cancel', and 'Help'.

Setting	Description	
Comment	User can describe the information of the object.	
	Bit Lamp / Toggle Switch Switch between Bit Lamp and Toggle Switch features.	
Read/Write use different addresses	Different addresses can be used to read data and write data.	
Read address	Click [Setting] to select the [PLC name], [Address], [Device type], [System tag], [Index register] of the bit device that controls the [Toggle Switch] object. Users can also set address in [General] tab while adding a new object. Invert signal Reverses the display of ON / OFF states. For example, if [Invert signal] check box is selected, when the designated bit is OFF, the object displays ON state. When [Read/Write use different addresses] option is not selected, the title of this group box will be "Read/Write address".	
Write address	Click [Setting] to select the [PLC name], [Address], [Device type], [System tag], [Index register] of the bit device that controls the [Toggle Switch] object. Users can also set address in [General] tab while adding a new object. The address can be the same or different from [Read address]. Write after button is released If this function is selected, the action is delayed till button is released, otherwise, the action is executed once the button is pressed. This function does not work with momentary buttons.	
Attribute	Set style	Description
	Set ON	Set ON the designated bit of the device.
	Set OFF	Set OFF the designated bit of the device.
	Toggle	Alternates the bit state each time pressed.
	Momentary	Holds the bit ON only while button is pressed.
Macro	Toggle Switch object can trigger the start of a Macro routine when the Macro has been created in advance.  For more information, see "18 Macro References".	

13.7. Multi-State Switch

13.7.1. Overview

Multi-state Switch object is a combination of Word Lamp object and Set Word object. The appearance of the object is controlled by the value of the read word address. As well, pressing the button sets the value in the word address according to the settings.

13.7.2. Configuration

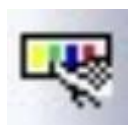

Click the Multi-State Switch icon on the toolbar to open a Multi-State Switch object property dialog box. Set up the properties, press OK button, and a new Multi-State Switch object will be created.

General Tab

cMT Series

eMT, iE, XE, mTV Series

Setting	Description
Comment	User can describe the information of the object. Word Lamp / Multi-State Switch Switch between Word Lamp and Multi-State Switch features.
Model / Offset	Different modes can be selected: [Value], [LSB].  For more information, see "13.2 Word Lamp".
Read/Write use different addresses	Different addresses can be used to read data and write data.
Read address	Click [Setting] to select the [PLC name], [Address], [Device type], [System tag], [Index register] of the word device that controls the Multi-state Switch object. Users can also set address in [General] tab while adding a new object. When [Read/Write use different addresses] option is not selected, the title of this group box will be "Read/Write address".
Write address	Click [Setting] to select the [PLC name], [Address], [Device type], [System tag], [Index register] of the word device that controls the Multi-state Switch object. Users can also set address in [General] tab while adding a new object. Write after button is released If this function is selected, the action is delayed till button is released; otherwise, the action is executed once the button is pressed.
Attribute	Switch style Select the object's operation mode, see Example 1. User-defined mapping The value placed in the write register of each selection, the action taken when an illegal value is entered, and error notification to a designated bit address can be set.

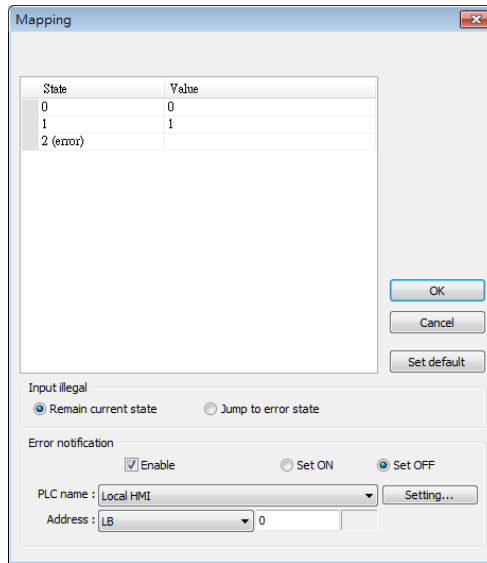

Remain current state

If an illegal value is entered, Multi-state Switch will remain at the current state.

Jump to error state

If an illegal value is entered, Multi-state Switch will jump to the error state.

Error notification

If an illegal value is entered, automatically set the value placed in the designated register.

Send

notification after writing successfully

After the system successfully writes data to PLC, the designated bit address will be set On/Off.

Error handling (cMT-SVR Series)

The action taken when an illegal value is entered or notify a designated bit address. This is similar to [User-defined mapping]; the difference is the value corresponding to each state need not to be preset.

Example 1

- JOG+

Increase the value of a designated register by 1 each time when pressing the button, till the value equals to [No. of states]. A cyclic action can be enabled. As shown below, each time when pressing the button, the state number will add 1 start from state 0, till state 4 ([no. of state]-1), and returns to 0 and step up again.

Attribute

Switch style : JOG+ No. of states : 5

Cyclical : Enable

User-defined mapping

- JOG-

Decrease the value of the designated register by 1 each time when pressing the button, till the value equals to 0. A cyclic action can be enabled. As shown below, each time when pressing the button, the state number will minus 1 start from state 4 ([no. of state]-1), till state 0, and returns to state 4 and step down again.

Attribute

Switch style : JOG- No. of states : 5

Cyclical : Enable

User-defined mapping

13.8. Slider

13.8.1. Overview

Slider object is used to change the value in a designated word register address by moving the slide on the screen.

13.8.2. Configuration



Click the Slider icon on the toolbar to open a Slider object property dialog box. Set up the properties, press OK button, and a new Slider object will be created.

General Tab

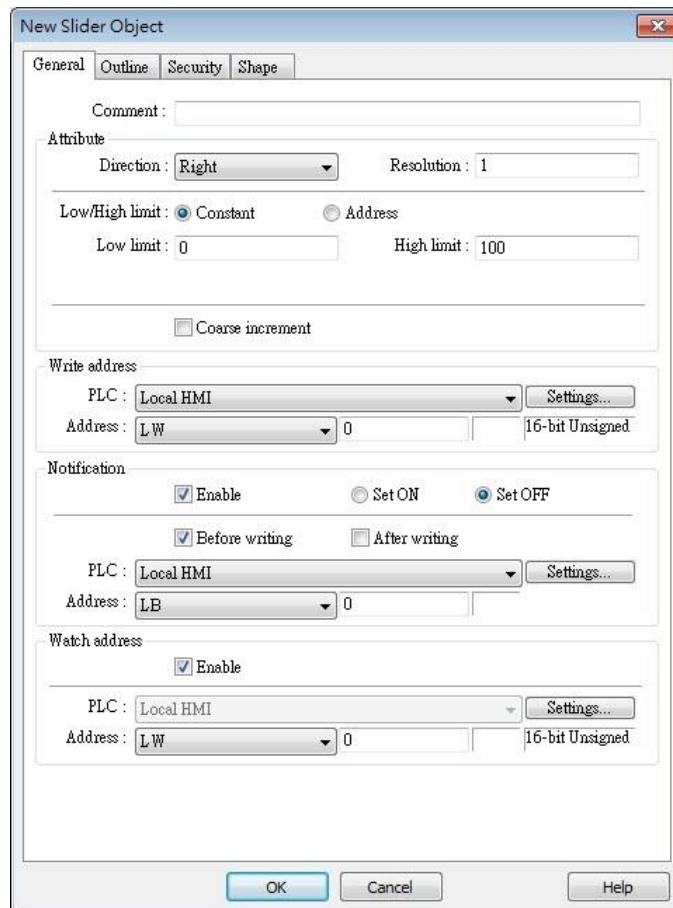

Setting	Description
Attribute	Direction Select the direction of the slider. (Right, Up, Left, Down)

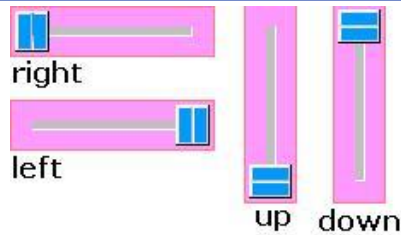
**Resolution**

Sets the value change in the word register for each step of the Slider. For example, if set to 10, the register value changes by 10 points for each increment or decrement on the Slider.

Constant

Sets the range of the Slider. For example, If set [Low limit] to 5, and [High limit] to 100, the Slider will enter values between 5 and 100.

Address

Set the [Low/High limit] by a designated register, see Example 1.

Coarse increment

Apart from moving the roller to change the value as in [Resolution], if this option is selected, the word value will increase / decrease by the [Increment] value each time the object is touched.

Write address

Click [Setting] to select the [PLC name], [Address], [Device type], [System tag], [Index register] of the word device that controls the Slider object. Users can also set address in [General] tab while adding a new object.

Notification

If enabled, the state of a designated bit address will be set to ON or OFF before or after writing.

Click **[Setting]** to select the [PLC name], [Address], [Device type], [System tag], [Index register] of the bit device that controls the notification settings. Users can also set address in [General] tab while adding a new object.

[Before writing] / [After writing]

Change the state of a designated bit register before, or after the slider is slid.

Watch address

When moving the roller, the new value written to the word register address can be displayed in real time.

Example 1

Set the low or high limit by a designated register. When write address is LW-n, where n is an arbitrary number, the rule of setting limits is:

Content	16-bit	32-bit
Address	LW-n	LW-n
Low limit	LW-n	LW-n
High limit	LW-n+1	LW-n+2

When address is LW-100, the rule of setting limits is:

Content	16-bit	32-bit
Address	LW-100	LW-100
Low limit	LW-100	LW-100
High limit	LW-101	LW-102

Outline Tab

cMT Seires

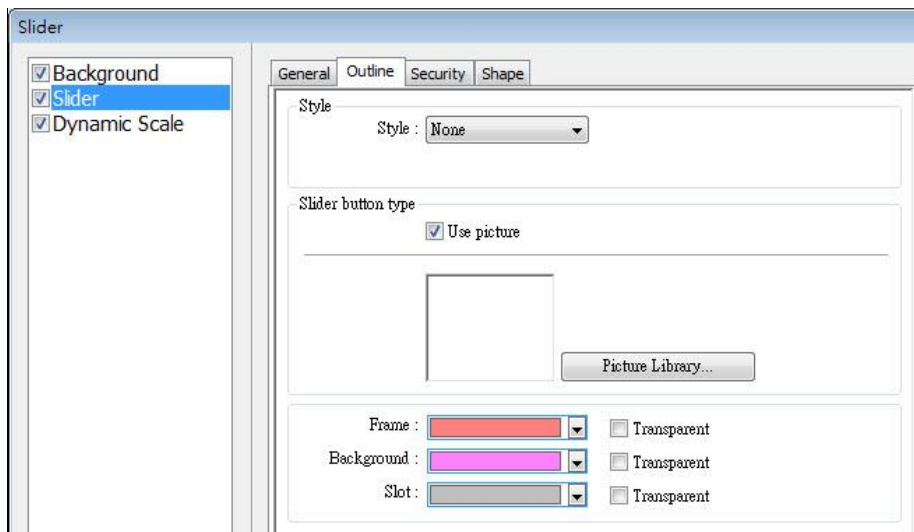

eMT, iE, XE, mTV Seires

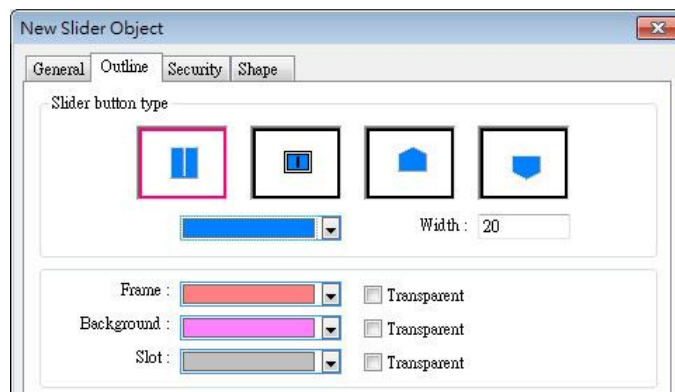

Setting	Description
Slider button type	<p>Use picture (cMT Series only)</p> <p>If this checkbox is selected, a picture can be selected from the Picture Library to be the slider button.</p> <p>Four default styles are offered here, and the width of the Slider may be set.</p> <p>Color</p> <p>Colors of the frame, background, and slot may be chosen.</p>

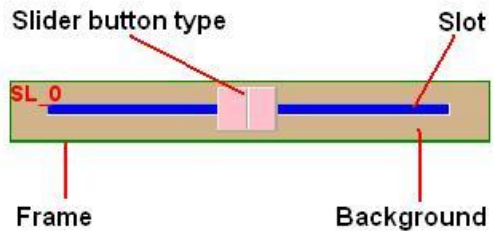

13.8.3. Combo Setting

cMT Series HMI support combo setting for Slider, which allows setting of multiple related objects at a time. Slider can be set with Background and Dynamic Scale.

Background

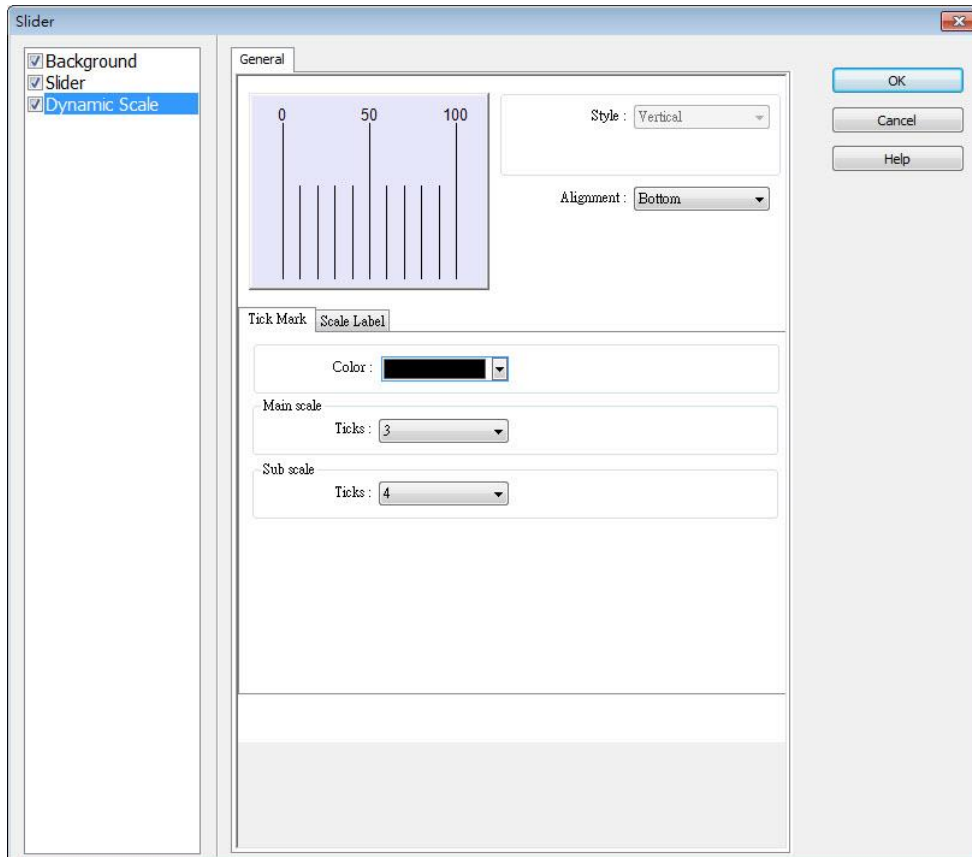

Setting	Description
Margin	Specify the space between the background edge and the objects.

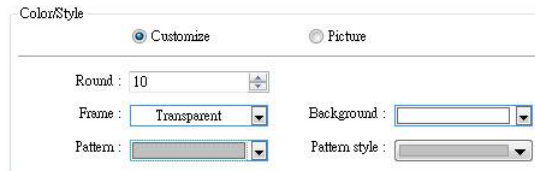
Color/Style**Customize**

Colour/Style

Customize Picture

Round : 10

Frame : Transparent

Background : [Color Picker]

Pattern : [Pattern Picker]

Pattern style : [Style Picker]

Select a suitable background pattern and color.

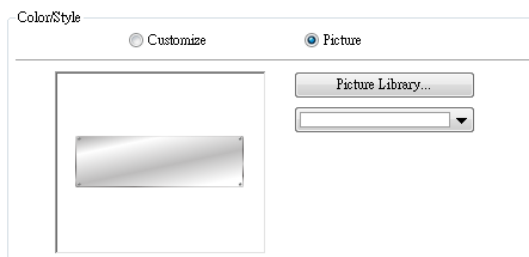
Picture

Colour/Style

Customize Picture

Picture Library...

[Preview Window]

Use the default picture or choose a picture from Picture Library.

Dynamic Scale

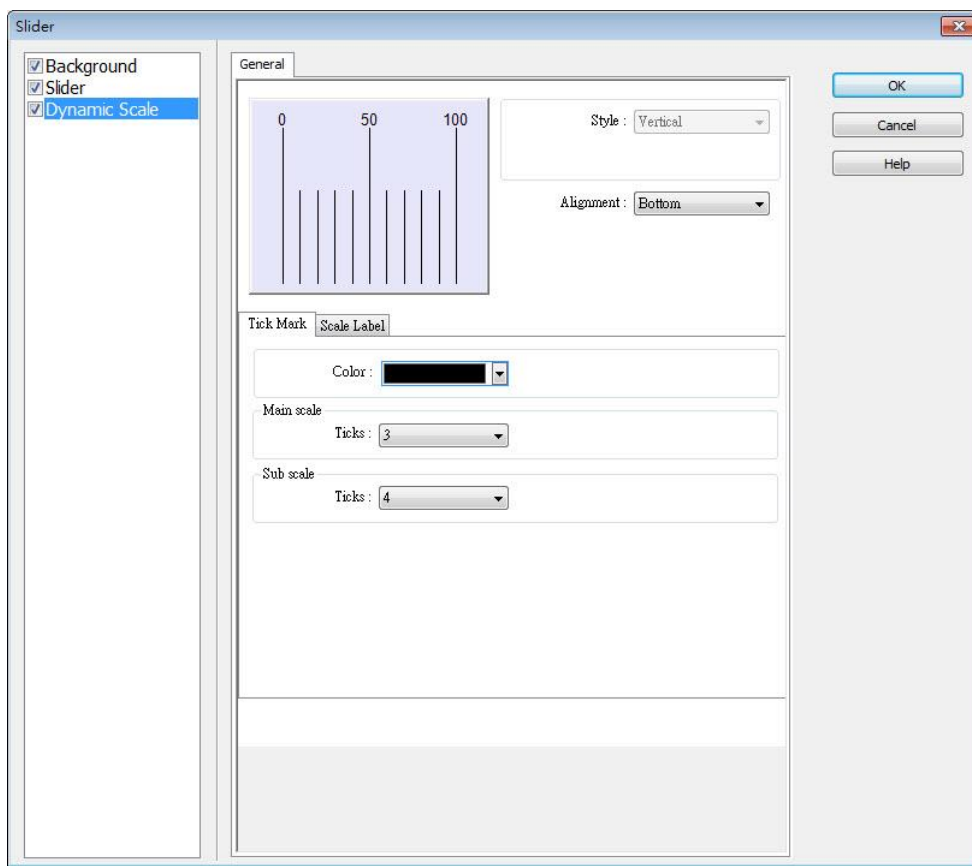

Setting	Description
Style	The scale style will follow the Slider.
Alignment	The position of the scale bar along the Slider.
Tick Mark	Configure the number of tick marks for main and sub scales, and the color of tick marks.
Scale Label	Configure the font, font color, font size and other attributes of scale label. In Slider settings if [Address] is selected for Low/High limit, then Scale Label's [Dynamic limits] will be set automatically. In Slider settings if [Left] is selected for Direction, then Scale Label's [Reverse (Left/Right)] will be set automatically.

Tick Mark Scale Label

Use scale label

Font: Arial

Color: Size: 10

Left decimal Pt.: 4 Right decimal Pt.: 0

Position: Top

Dynamic limits

Reverse (Left/Right)

Left: LW-1 Right: LW-0

13.9. Numeric

13.9.1. Overview

Numeric object can be used to input or display the value of a designated word register.

13.9.2. Configuration



Click the Numeric icon on the toolbar to open a Numeric object property dialog box. Set up the properties, press OK button, and a new Numeric object will be created.

General Tab

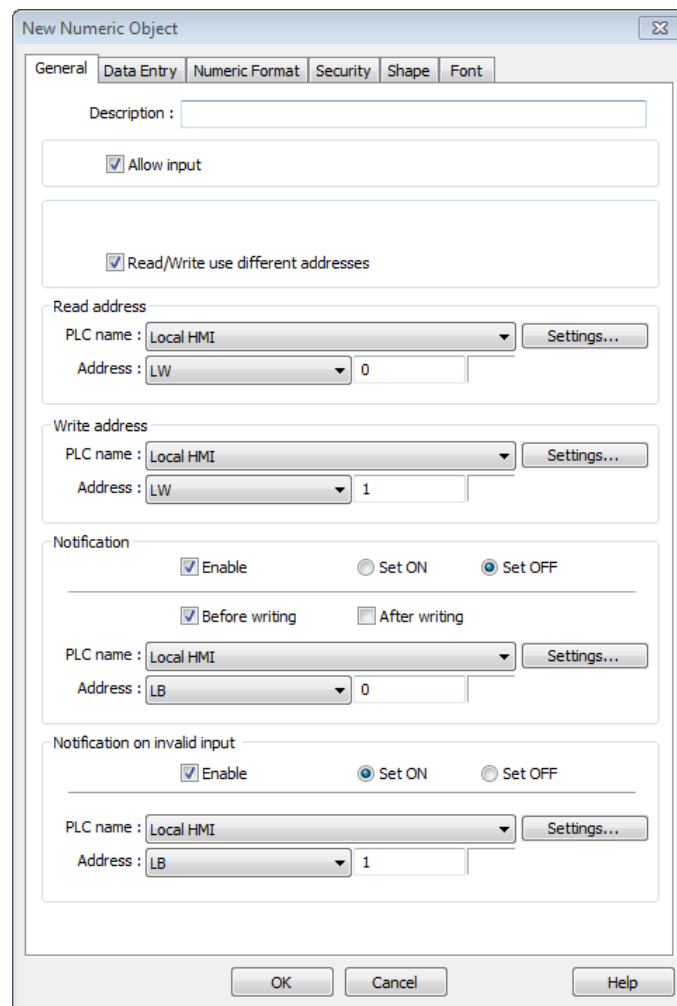

The screenshot shows the 'New Numeric Object' dialog box with the 'General' tab selected. The dialog has several sections for configuration:

- Description:** A text input field.
- Allow input:** A checked checkbox.
- Read/Write use different addresses:** A checked checkbox.
- Read address:** A section with a 'PLC name' dropdown set to 'Local HMI', an 'Address' dropdown set to 'LW', and a value input field set to '0'. A 'Settings...' button is next to the PLC name dropdown.
- Write address:** A section with a 'PLC name' dropdown set to 'Local HMI', an 'Address' dropdown set to 'LW', and a value input field set to '1'. A 'Settings...' button is next to the PLC name dropdown.
- Notification:** A section with 'Enable' checked, 'Set ON' and 'Set OFF' radio buttons, and 'Before writing' checked. Below this are 'PLC name' and 'Address' fields (set to 'Local HMI' and 'LB', '0' respectively) with a 'Settings...' button.
- Notification on invalid input:** A section with 'Enable' checked, 'Set ON' and 'Set OFF' radio buttons. Below this are 'PLC name' and 'Address' fields (set to 'Local HMI' and 'LB', '1' respectively) with a 'Settings...' button.

At the bottom of the dialog are 'OK', 'Cancel', and 'Help' buttons.

Setting	Description
Allow input	If selected, the input features and relevant settings are enabled.
Read / Write use different address	Different addresses can be used to read data and write data.
Read address	Click [Setting] to select the [PLC name], [Address], [Device type], [System tag], [Index register] of the word device that displays the value. Users can also select a tag defined in Address Tag Library. When [Read/Write use different addresses] option is not selected, the title of this group box will be "Read/Write address".
Write address	Select the [PLC name], [Device type], [Address] of the word device that system writes to.
Notification	If this check box is selected, it will notify a designated bit address (setting ON or OFF). Before writing / After writing Set the state of the designated bit address before or after the manual operation.
Notification on invalid input	If an illegal value is entered, automatically set the state of a designated register.

Data Entry Tab

cMT-SVR

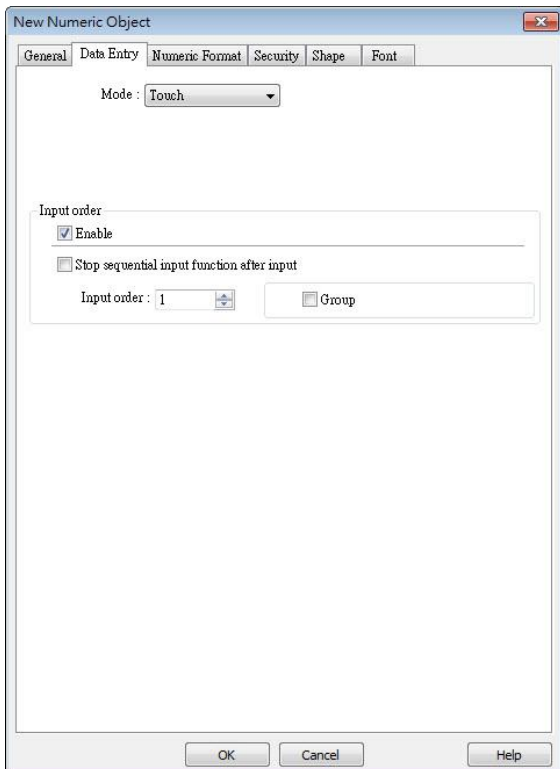

cMT3151

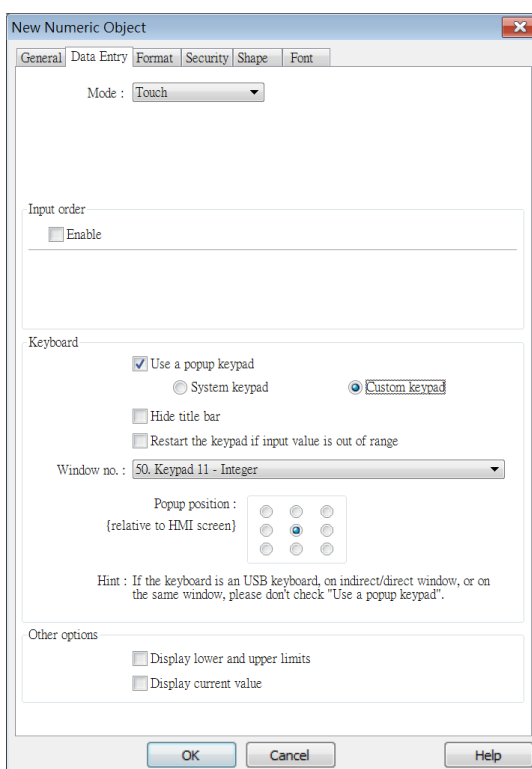

eMT, iE, XE, mTV Series

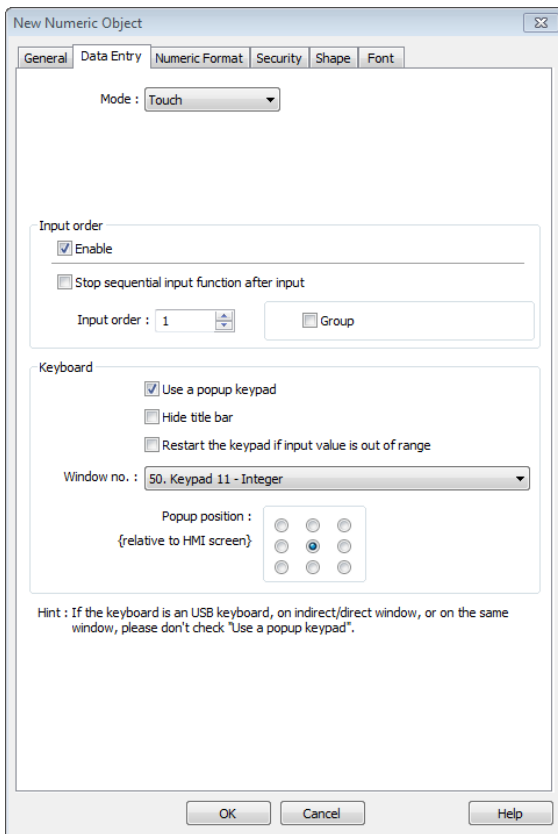

Setting	Description
Mode	Touch Used when data entry is initiated by touching the screen object.
Allow input bit address	Bit control Used when data entry is enabled by turning ON a designated bit, and entry ends when the bit goes OFF.
Input order	Specify a bit address that enables or ends data entry. The order of data entry is specified in [Input order] and an external USB keyboard is needed for data entry. For cMT-SVR, use iPad's keyboard. Perform continuous input by setting [Input order] and [Group]. The criterion of searching the next input object: <ul style="list-style-type: none"> ● The range of [Input order]: 1 ~ 511, range of [Group]: 1 ~ 15. ● If [Group] is not selected, its input order is 0. ● The system only searches for the objects within the same Group. ● The lower number of order is entered before the higher number of order. ● For multiple objects within the same group and with the same

input order, the object placed in the lower layer is entered first.

Keyboard

(For eMT, iE, XE, mTV Series, and cMT3151)

Use a popup keypad

If selected: A pre-designed pop-up keypad can be chosen by selecting a check box, and selecting the relative position on the HMI screen. When data entry is enabled, the pop-up keypad displays in the selected position, and closed when data entry ends. If this check box is selected in cMT3151 Keyboard settings, to use a customized keypad, please select [Custom keypad].

If not selected: When data entry is enabled, the pop-up keypad is not displayed. Users may:

- Create a custom design on the same screen window.
- Use a USB keyboard.

Hide title bar

Use a keypad without the title bar.

Restart the keypad if input value is out of range

When entering data, if the value entered is not within the valid range, the system will automatically restart the keypad.



Note

- The iPad’s keyboard is used to enter data for cMT-SVR. To use a built-in keyboard for cMT3151, select [Use a popup keypad] check box in Keyboard group box, and then select [System keypad].



To create a keyboard in current window, see “12 Keypad Design and Usage”.

Example 1

This example demonstrates how to use [Input Order] and [Group] to perform continuous input in several Numeric objects. After entering data in one object, entry will be passed to the next input order object which is in the same group.

1. Create three Numeric objects, and set [Input order] to 1, 2, and 3 respectively. Include the three objects in [Group 1] as shown in the following figure.

LW-0

LW-1

LW-2

Input order

Enable

Stop sequential input function after input

Input order : 3

Group 1



2. When finish entering data in the last object, to end data entry of all objects, please select [Stop sequential input function after input] check box.

Input order

Enable

Stop sequential input function after input

Input order : 3

Group 1

Numeric Format Tab

cMT Series

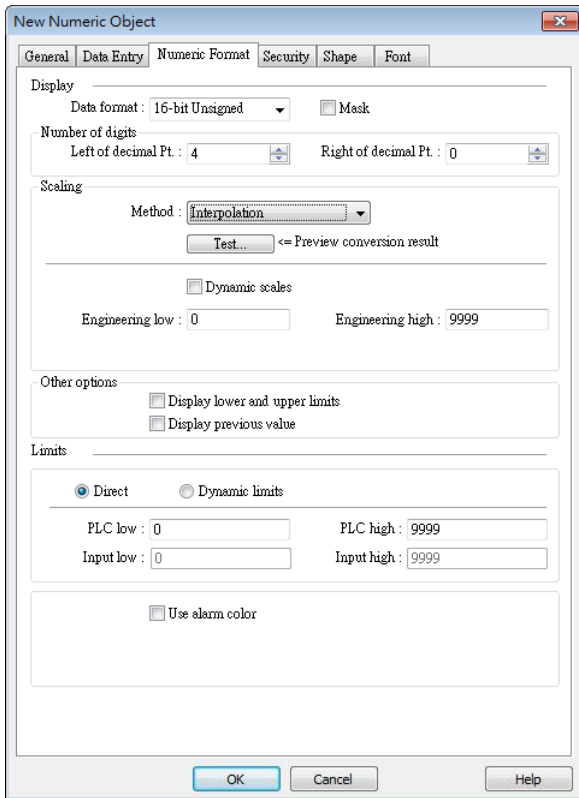

eMT, iE, XE, mTV Series

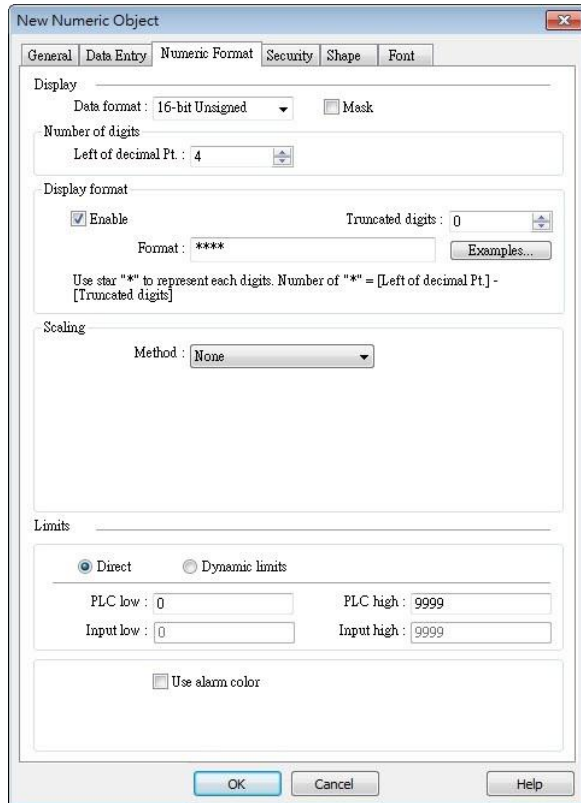

Setting	Description
Display	Data Format Set the data format of a designated word register. The selections include: BCD, HEX, Binary, Unsigned, Signed, Float. 16-bit uses 1 word where 32-bit uses two words.
	Mask If selected, any values entered will be hidden by displaying them as ****.
Number of digits	Left of decimal Pt. The number of digits before the decimal point.
	Right of decimal Pt. The number of digits after the decimal point.
Display format (Not supported by cMT-SVR)	Each "*" sign represents each digit that will be displayed in the Numeric object. Apart from "*" signs, extra texts can be entered in the [Format] field, for example: kg. The available alignment options are: [Left], [Center], [Right], [Leading zero]. The numeric value represented by "*" sign will be displayed from

the highest digit to the lowest in the Numeric object.

Truncated digits

Specify the number of digits to be truncated, from the lowest digit to the highest.

The number of "*" signs = [Left of decimal Pt.]-[Truncated digits]

Please see the following examples:

Example 1

[Left of decimal Pt.] = 5, [Truncated digits] = 0, so 5 stars "*" must be used.

Use [Format] = "***kg***g" and [Align] = "Leading zero"

=> If read data is 12345, the result will be "12kg345g"

=> If read data is 123, the result will be "00kg123g"

Example 2 : Change [Truncated digits]

[Left of decimal Pt.] = 5, [Truncated digits] = 2,

so 3 stars "*" must be used and last two digits will be truncated.

Use [Format] = "***kg*00g" and [Align] = "Leading zero"

=> If read data is 12345, the result will be "12kg300g"

=> If read data is 123, the result will be "00kg100g"

Example 3 : Use "Left" Align

[Left of decimal Pt.] = 5, [Truncated digits] = 0, so 5 stars "*" must be used.

Use [Format] = "Total: **kg***g" and [Align] = "Left"

=> If read data is 12345, the result will be "Total : 12kg345g"

=> If read data is 123, the result will be "Total : 123g"

When leading zero is not used, the text enclosed in two "*" signs will not show, for example:

[Left of decimal Pt.] = 5, [Truncated digits] = 0, and Display Format is "Total=**kg***g"

If the data read is 255, the result would be: "Total=255g"

If the data read is 1000, the result would be: "Total=1kg000g"

Scaling

Interpolation

If this check box is selected, [Engineering low] and [Engineering high] boxes appear. Values entered in these boxes correspond to the display range required. The setting also requires [Input low] and [Input high] in the limits section. See Example 2.

Test: Preview the result of Interpolation. See Example 2.

Dynamic scales: Set the [Engineering low] and [Engineering high] by a designated register. See Example 4.

Macro subroutine (Not available for cMT Series)

The value read from or written to the register can be computed by macro subroutines selected in [Read conversion] and [Write conversion]. The macro subroutines should be defined in Macro

	Function Library. To use this feature, see “13.9.2.1 The rule of using Macro subroutine”.
Other options (For cMT Series)	<p>Display lower and upper limits If selected, when entering a value, the range is displayed near the object.</p> <p>Display previous value If selected, when entering a value, the value before update is displayed near the object.</p>
	
Limits	<p>This section allows users to apply display limits to the values held in the input register. The color when the register value is outside limits can be set.</p> <p>Direct Sets the limits by entering values in [Input low] and [Input high]. If the value entered is outside the limits, the value in the register cannot be changed.</p> <p>Dynamic limits Set the limits by a designated register, see Example 5.</p>
Use alarm color	<p>Low limit When the value in the register is outside the [Low limit], display digits by the color set.</p> <p>High limit When the value in the register is outside the [High limit], display digits by the color set.</p> <p>Blink When the value in the register is outside either limit, the digits flash.</p>

13.9.2.1. The rule of using Macro Subroutine

- There must be a return value and exactly one parameter.

Examples:

```
sub char test (short a) // (Correct)
```

```
sub test (char a) // (Incorrect, no return value.)
```

```
sub char test (char a, char b) // (Incorrect, two parameters.)
```

- Use the Macro data type that corresponds to the object’s data format.

The mapping is as follows:

Macro Data Type	Numeric Object Data Format
short	16-bit Signed
Int	32-bit Signed
unsigned short	16-bit BCD, 16-bit HEX, 16-bit Binary, 16-bit Unsigned
unsigned int	32-bit BCD, 32-bit HEX, 32-bit Binary, 32-bit Unsigned
float	32-bit Float

For example, if the data format of the numeric object is 16-bit Unsigned, only the corresponding Macro data type: unsigned short, is available.

Examples:

```
sub char test(unsigned short a) // (Correct)
sub char test(char a) // (Incorrect)
```

- Supports only the local HMI address.

Examples:

```
GetData(var, "Local HMI", LB, 0, 1) // (Correct)
GetData(var, "MODBUS RTU", 0x, 0, 1) // (Incorrect)
```

- The following system defined functions are unable to be invoked:
ASYNC_TRIG_MACRO, SYNC_TRIG_MACRO, DELAY, FindDataSamplingDate,
FindDataSamplingIndex, FindEventLogDate, FindEventLogIndex, INPORT, INPORT2, OUTPORT,
PURGE, TRACE

- The following statements are not supported:

For-Next, While-Wend

Example 2

If [Interpolation] is selected, the scaling equation is as the following:

If A indicates the original data and B indicates the displayed data:

$$B = [\text{Engineering low}] + (A - [\text{PLC low}]) \times \text{Ratio}$$

where, $\text{Ratio} = ([\text{Engineering high}] - [\text{Engineering low}]) / ([\text{PLC high}] - [\text{PLC low}])$

As shown below, the original data is 15, after conversion, 40 will be displayed.

Scaling

Method :

<= Preview conversion result

Dynamic scales

Engineering low : Engineering high :

Limits

Direct Dynamic limits

PLC low : PLC high :

Input low : Input high :

Click [Test] button to preview the result of Interpolation. Enter a value in [PLC] field as shown in the following figure, for example, enter value 15, and the result, which is 40, will be displayed.

Conversion Test

Number of digits

Left of decimal Pt. : Right of decimal Pt. :

HMI Engineering low PLC PLC low Engineering high Engineering low

= + (-) x $\frac{\text{Engineering high} - \text{Engineering low}}{\text{PLC high} - \text{PLC low}}$

PLC high PLC low

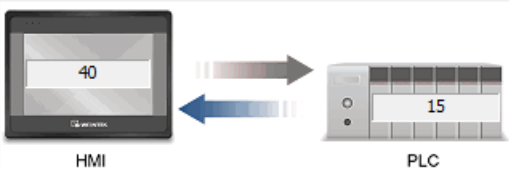

HMI PLC

Example 3

If the numeric format selected is not Float and decimal point is used, the decimal place of the converted result will not be adjusted automatically, please adjust [Engineering high] to correctly place the decimal point of the result gained in [Interpolation] mode. Please see the illustration below.

1. Create two Numeric objects, set [Right of decimal Pt.] to 1 and select [Interpolation] method for one of the objects as shown in the following figure.

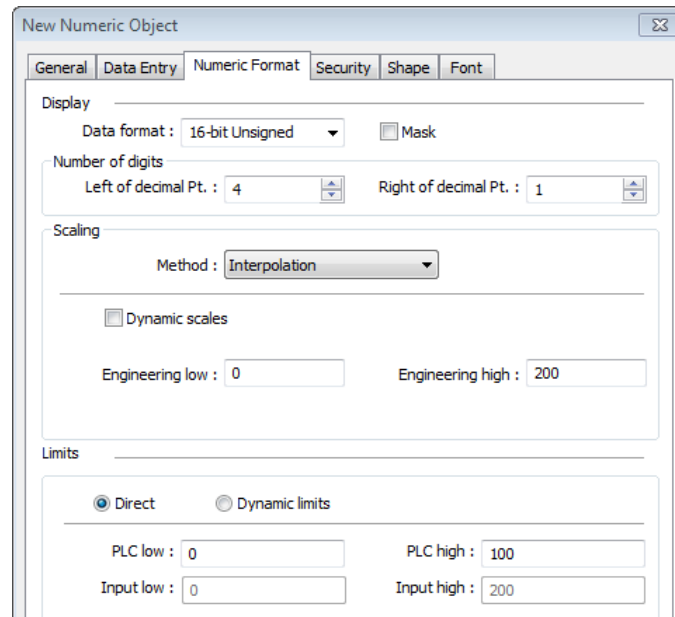

2. Enter value “123”, the object set to [Interpolation] displays “246.0” instead of “24.6”.

Original Value

123

Converted Value

246.0

3. To move the decimal point one place to the left, adjust [Engineering high] as shown in the following figure.

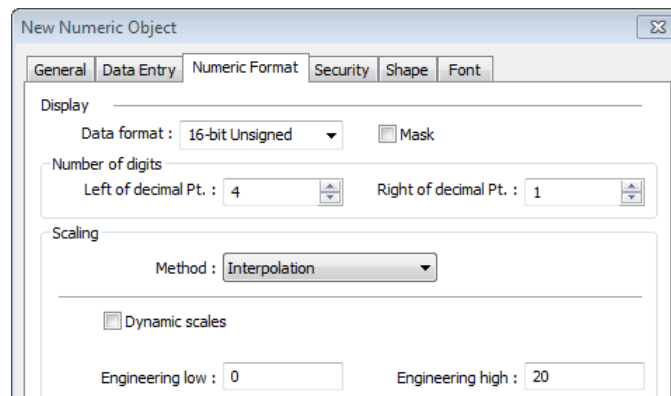

Original Value

123

Converted Value

24.6

Example 4

If [Interpolation] is selected, set the [Engineering low] and [Engineering high] by a designated register. When Dynamic Address is LW-n, where n is an arbitrary number, the rule of setting [Engineering low] and [Engineering high] is:

Content	16-bit	32-bit
Dynamic address	LW-n	LW-n
Engineering low	LW-n	LW-n
Engineering high	LW-n+1	LW-n+2

When address is LW-100, the rule of setting limits is:

Content	16-bit	32-bit
Dynamic address	LW-100	LW-100
Engineering low	LW-100	LW-100
Engineering high	LW-101	LW-102

Example 5

Set the limits by a designated register. When [Address] is LW-n, where n is an arbitrary number, the rule of setting limits is:

Content	16-bit	32-bit
Address	LW-n	LW-n
Low limit	LW-n	LW-n
High limit	LW-n+1	LW-n+2

When address is LW-100, the rule of setting limits is:

Content	16-bit	32-bit
Address	LW-100	LW-100
Low limit	LW-100	LW-100
High limit	LW-101	LW-102

Example 6

The following demonstrates how to use [Macro subroutine] for scaling when configuring Numeric object.

The following two macros are used, one for [Read conversion] and one for [Write conversion].

Read Conversion

```
sub short read(unsigned short a)
short b
b = a + 10
return b
end sub
```

Write Conversion

```
sub short write(unsigned short a)
short b
b = a - 10
return b
end sub
```

1. Create two Numeric objects: NE_0 and NE_1 and use the same control address. Select [Macro subroutine] for NE_1.



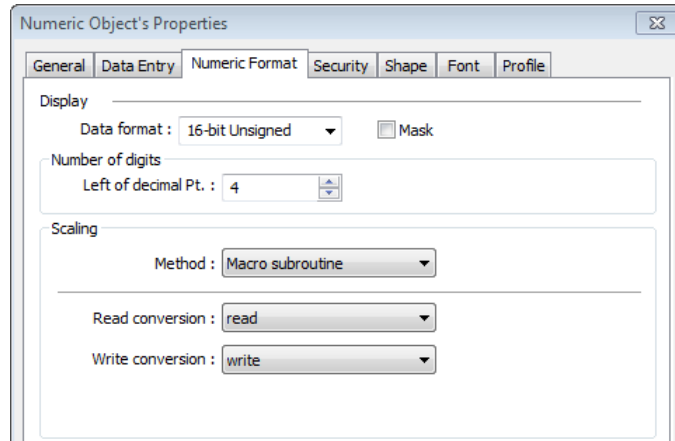

2. Enter 0 in NE_0 then NE_1 will execute [Read conversion]. The value gained will be 10.

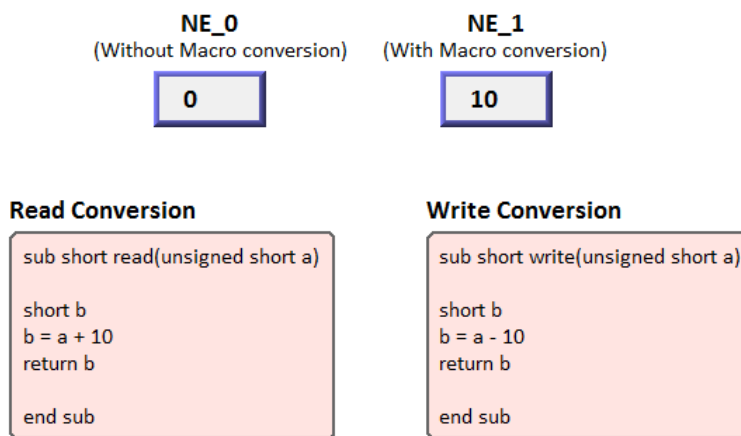

3. Enter 80 in NE_1, [Write conversion] is executed and the value gained will be 70. NE_0 displays 70.

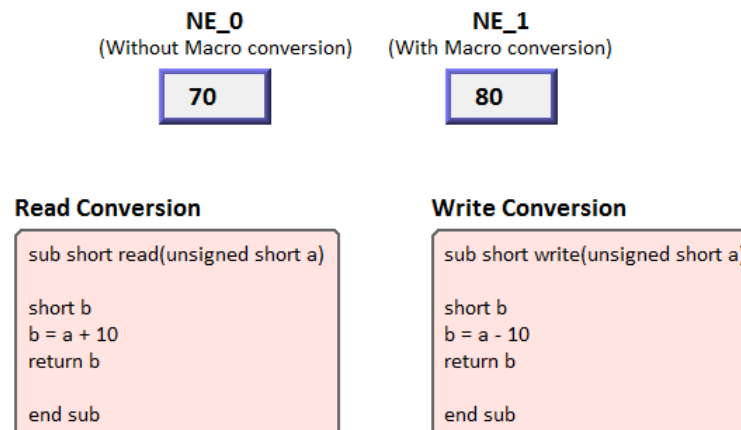

Note

- If executing [Read conversion] and [Write conversion] by the same numeric object, the value entered in this object is computed by the Macro subroutine of [Write conversion] first, and then the result is computed by the Macro subroutine of [Read conversion]. In

Example 5, if the subroutine of [Write conversion] is set to $b=a-20$, then entering 80 in NE_1 will get 60 after [Write conversion] and then the object displays 70 after [Read conversion].

Security Tab

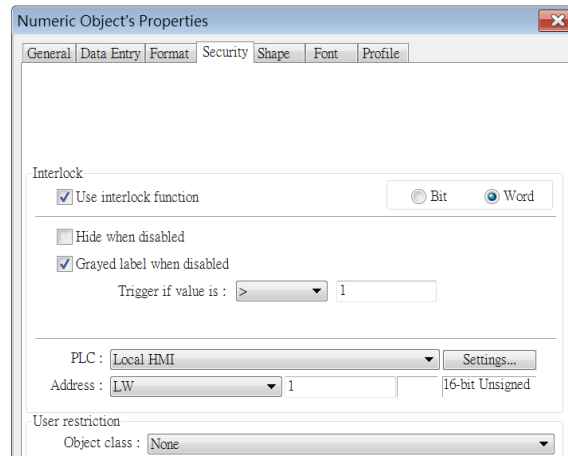

Setting

Description

Interlock

Use interlock function

When this option is enabled and [Word] is selected, whether the object is operable depends on the condition of a word address specified in [Trigger if value is:]. In the settings above, the object is operable only when the value in LW-1 is greater than 1.

Hide when disabled

The object is hidden when the specified condition does not occur in the specified word address.

Grayed label when disabled

The value in the object turns gray when the specified condition does not occur in the specified word address.

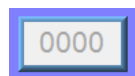

Trigger if value is:

This setting is for specifying a trigger condition. The available options are: >, <, ==, <>, >=, and <=. A tolerance value can be set for conditions == and <>.

For example:

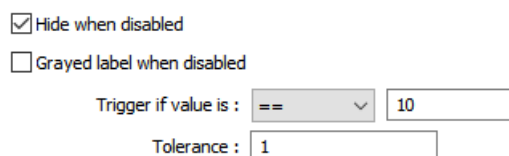

When the value in the specified word address is greater than

or equal to 11, or smaller than or equal to 9, the object will be hidden and is not operable.

Font Tab

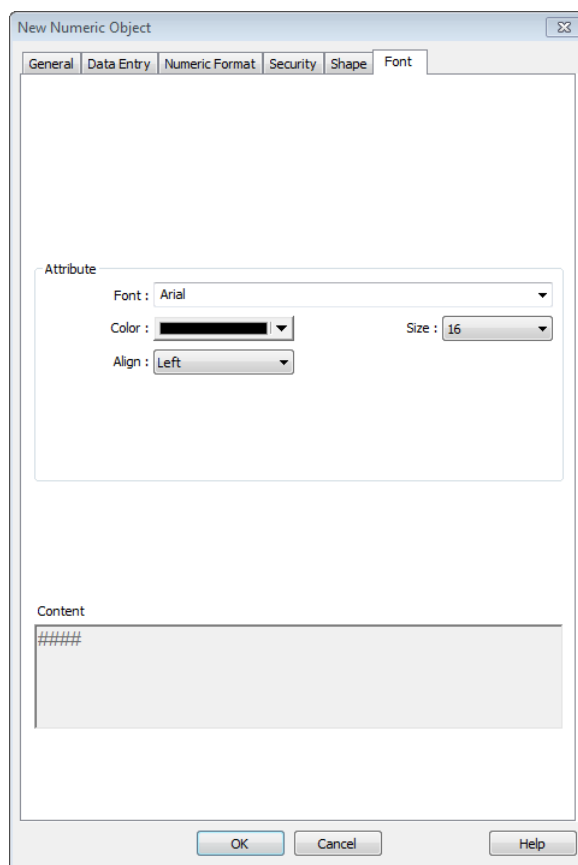

Setting	Description
Color	When the value is within the limits, display digits using color set in this tab.
Align	<p>Left: Align the number to the left.</p> <p>Center: Align the number to the center.</p> <p>Right: Align the number to the right.</p> <p>Leading zero: The number is preceded with leading zeros when the number of digits is less than that set.</p> <p>Left <input type="text" value="66"/></p> <p>Center <input type="text" value="66"/></p> <p>Right <input type="text" value="66"/></p> <p>Leading zero <input type="text" value="0066"/></p>
Size	Set the font size.

13.10. ASCII

13.10.1. Overview

ASCII object can be used to input or display ASCII or UNICODE characters held in designated word registers.

13.10.2. Configuration



Click the ASCII icon on the toolbar to open an ASCII object property dialog box. Set up the properties, press OK button, and a new ASCII object will be created.

General Tab

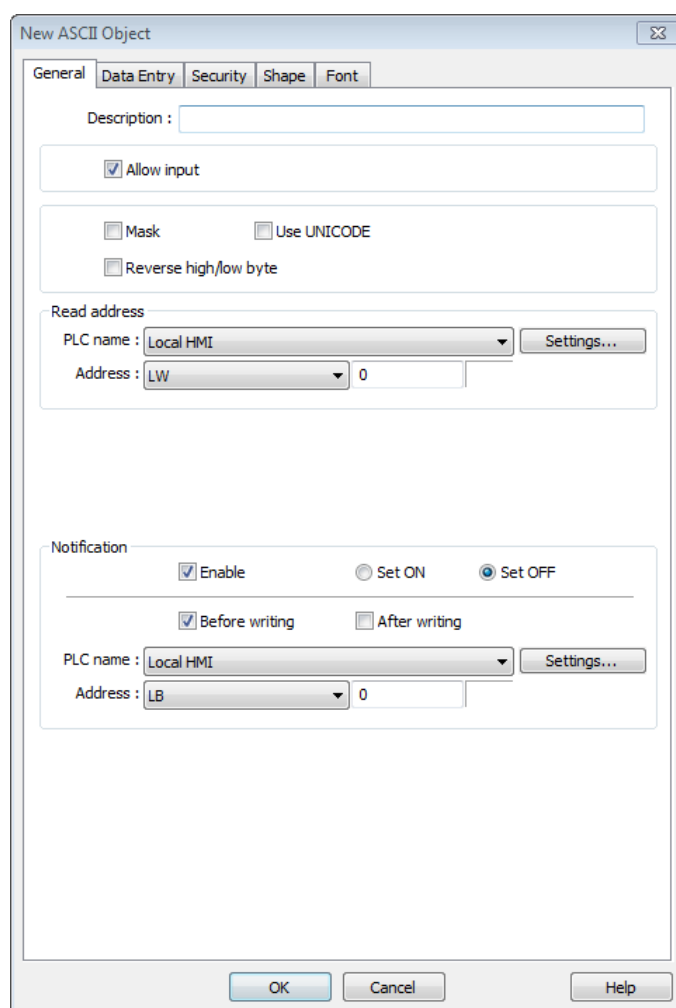

The screenshot shows the 'New ASCII Object' dialog box with the 'General' tab selected. The dialog has a title bar with a close button. Below the title bar are five tabs: 'General', 'Data Entry', 'Security', 'Shape', and 'Font'. The 'General' tab contains the following fields and controls:

- Description: A text input field.
- Allow input: A checked checkbox.
- Mask: An unchecked checkbox.
- Use UNICODE: An unchecked checkbox.
- Reverse high/low byte: An unchecked checkbox.
- Read address section:
 - PLC name: A dropdown menu showing 'Local HMI' and a 'Settings...' button.
 - Address: A dropdown menu showing 'LW' and a text input field containing '0'.
- Notification section:
 - Enable: A checked checkbox.
 - Set ON: An unselected radio button.
 - Set OFF: A selected radio button.
 - Before writing: A checked checkbox.
 - After writing: An unchecked checkbox.
 - PLC name: A dropdown menu showing 'Local HMI' and a 'Settings...' button.
 - Address: A dropdown menu showing 'LB' and a text input field containing '0'.

At the bottom of the dialog are three buttons: 'OK', 'Cancel', and 'Help'.

Setting	Description
Allow input	If selected, the input features and relevant settings are enabled.
Mask	If selected, any values entered will be hidden by displaying them as ****.
Use UNICODE	Select this check box to display data in UNICODE format. If not selected, the characters are displayed in ASCII format. This feature can be used with the [Function Key] object that uses [ASCII/UNICODE].
Reverse high/low byte	Normally an ASCII code is displayed in “high byte”, “low byte” order. Reverse selection makes the system display ASCII characters in “low byte”, “high byte” order.



The left object is in normal form, and another is high/low byte reversed.

Read address Click [Setting] to select the [PLC name], [Address], [Device type], [System tag], [Index register] of the word device that displays characters. Users can select a defined address tag from Address Tag Library, or set address in [General] tab while adding a new object.

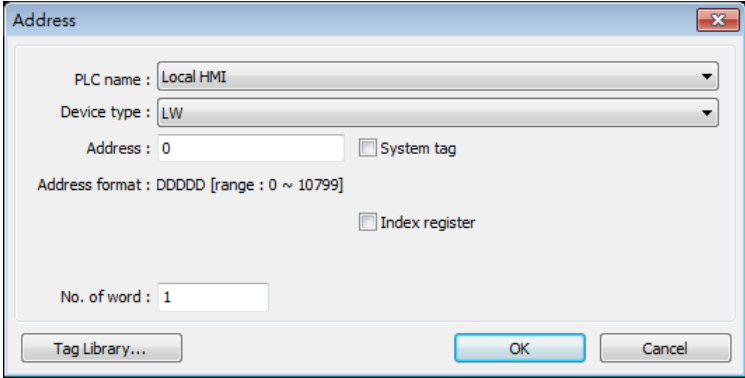

No. of words

Select the maximum number of words to be displayed.

Note

- An UNICODE character uses 1 word, and an ASCII character uses 1 byte. Therefore 1 word can be used as 1 UNICODE character or 2 ASCII characters. (1 word equals to 2 bytes)

Font Tab

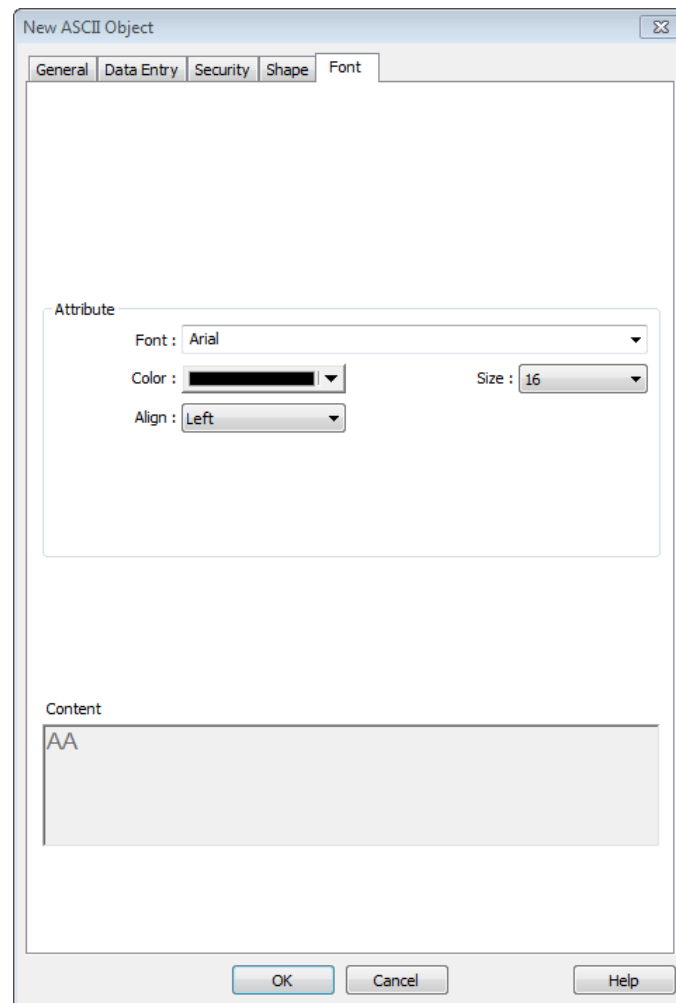

Setting	Description
Attribute	The font, size, color, and alignment can be set.
	Align
	Left: Align the text to the left.
	Center: Align the text to the center.
	Right: Align the text to the right.

13.11. Indirect Window

13.11.1. Overview

Indirect Window object opens the pop-up window assigned by a designated word register. There are two ways to use Indirect Window object: The first is to use the profile of Indirect Window object, and let the pop-up window be resized and displayed in the defined profile; the second is to automatically resize the window according to the size of the pop-up window to be displayed. To close the pop-up window, assign 0 to the designated word register. The difference between Direct Window and Indirect Window is that Direct Window is controlled by a bit register, while Indirect Window is controlled by a word register.

13.11.2. Configuration



Click the Indirect Window icon on the toolbar to open the object property dialog box. Set up the properties, press OK button, and a new Indirect Window object will be created.

General Tab

cMT Series

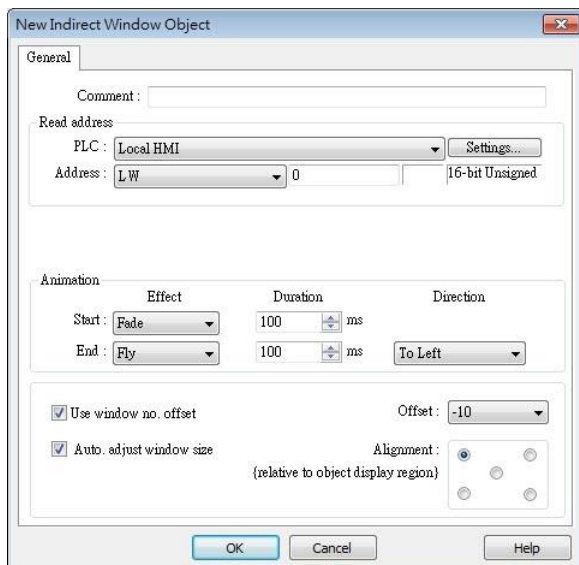

eMT, iE, XE, mTV Series

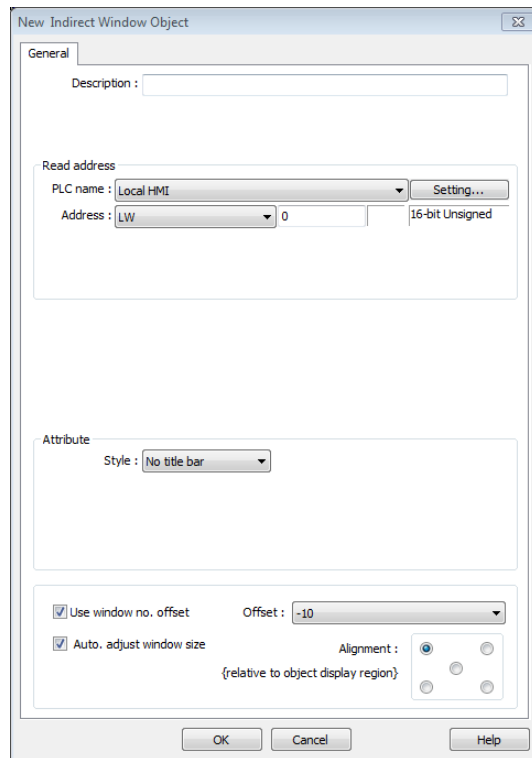

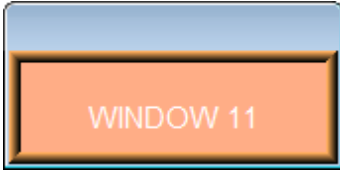
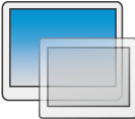
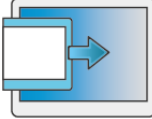
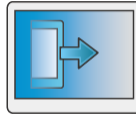
Setting	Description
Read address	Click [Setting] to select the [PLC name], [Address], [Device type], [System tag], [Index register] of the word device that controls the pop-up window. Users can also set address in [General] tab while adding a new object.
Attribute	<p>Style</p> <p>Set the display style of the pop-up window. There are two styles:</p> <ul style="list-style-type: none"> ● No title bar <p>The pop-up window has no title bar and cannot be dragged.</p>  <ul style="list-style-type: none"> ● With title bar <p>The pop-up window has a title bar that can be dragged to move the window.</p> 
Animation	<p>Effect</p> <p>Transition effects for</p> <ul style="list-style-type: none"> ● Opening popup windows using Function Keys. ● Opening or closing Direct or Indirect windows. <p>The effects are: Fade, Fly, and Float:</p> <div style="display: flex; justify-content: space-around; align-items: center;"> <div style="text-align: center;">  <p>Fade</p> </div> <div style="text-align: center;">  <p>Fly</p> </div> <div style="text-align: center;">  <p>Float</p> </div> </div> <p>Different effects may be used for Start (window appears) and End (window disappears).</p> <p>Duration</p> <p>Specifies how many milliseconds (ms) a transition effect takes to complete.</p> <p>Direction</p> <p>The direction of the transition.</p>

Use window no. offset Sets the offset of the window number for selecting the pop-up window. The window number of the pop-up window is calculated by the value in the word register added to the offset. For example, assume the value in the register is 20 and offset is 5, the pop-up window number will be 25.

Auto. adjust window size Automatically resize the Indirect Window and align the pop-up window to the preset region.

Alignment

Sets a reference point of the pop-up window from one of the five positions on the screen. For example, if the lower-right region is selected, the lower-right corner of the pop-up window is aligned to the lower-right region of the Indirect Window. See Example 1.

Example 1

Here is an example of using Indirect Window. The setting is shown in the following figure, set the address to LW-0 which assigns the window number. Create window no. 11 and 12 first.

1. Create an Indirect Window object, set address to LW-0, and select [Auto. adjust window size].
2. Select the region where the window is to be displayed.

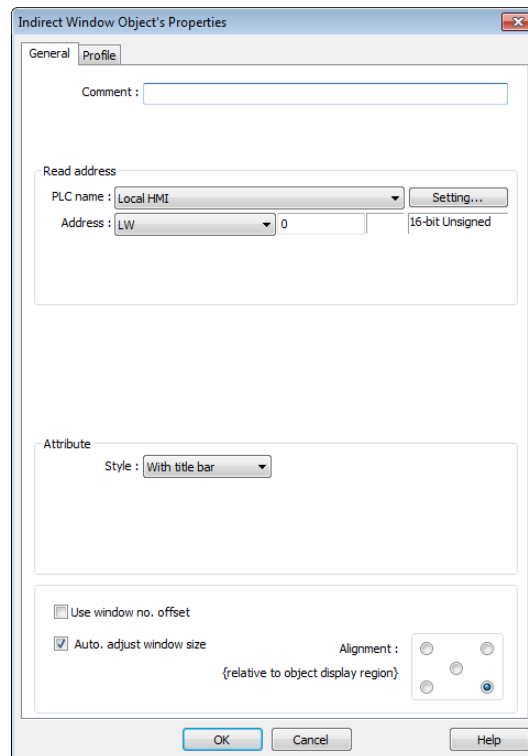

3. Enter value 11 in LW-0, the pop-up window displayed is window no. 11.
4. Enter value 12 in LW-0, the pop-up window displayed is window no. 12.
5. Enter value 0 in LW-0, the pop-up window is closed.

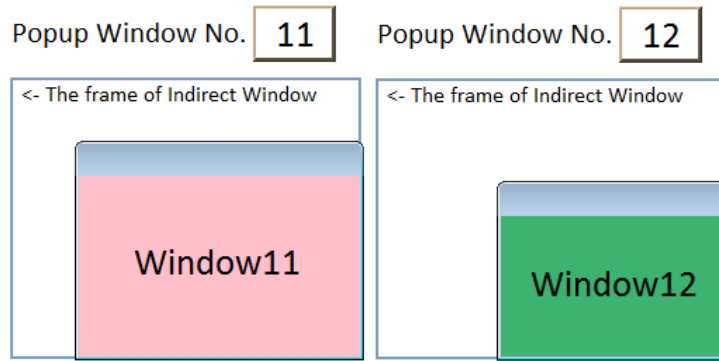

To close the pop-up window, apart from entering 0 in the designated word register, another way is to place a Function Key object in the pop-up window, and set the key to [Close window].

Note

- At most 24 windows can be displayed simultaneously at run time.
- The system does not allow opening the same window with two Direct (or Indirect) windows in one base window.
- If the pop up window has monopoly property enabled, then when the window pops up, all background windows may not be operated until the monopolizing window has been closed.

13.12. Direct Window

13.12.1. Overview

Direct Window object defines the position and size of a pop-up window location on a window. When the content of the bit register is changed, the window will pop up at the predefined location. The display area for the pop-up window is limited by the size of predefined location. Restoring the value of the bit register closes the pop-up window. The difference between the Direct Window and the Indirect Window is that Direct Window object has a predefined window number, and is controlled by a bit register, while Indirect window is controlled by a word register, and the value of the word register determines the window displayed.

13.12.2. Configuration



Click the Direct Window icon on the toolbar to open a Direct Window object property dialog box. Set up the properties, press OK button, and a new Direct Window object will be created.

General Tab

cMT Series

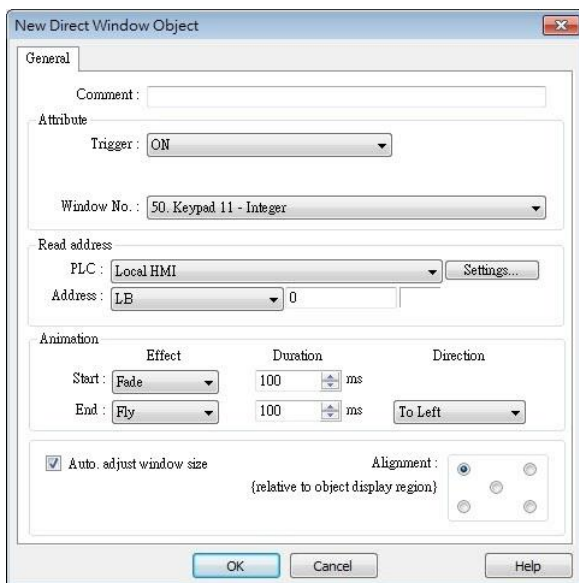

eMT, iE, XE, mTV Series

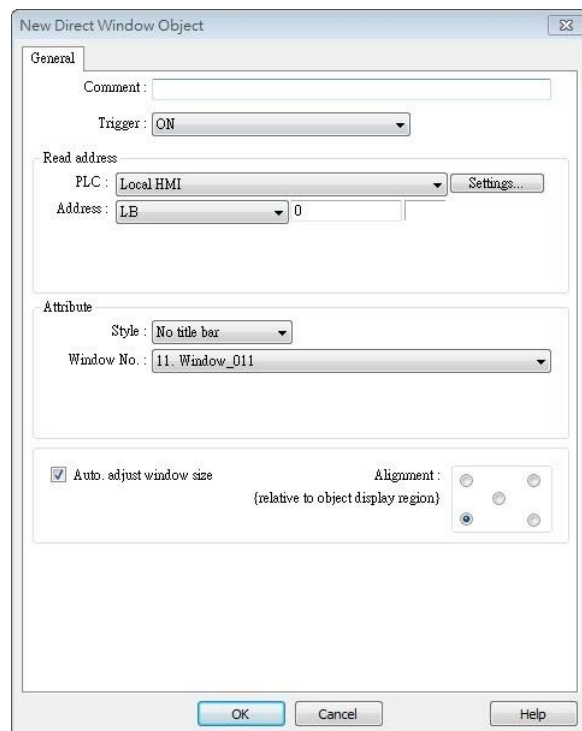

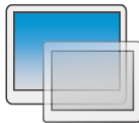
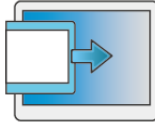
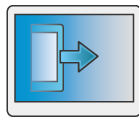
Setting	Description
Read address	Click [Setting] to select the [PLC name], [Device type], [Address], [System tag], [Index register] of the bit device that control the window popup. Users can select a defined address tag from Address Tag Library, or set the address in [General] tab while adding a new object.
Attribute	<p>Style Define the pop-up window style. Two styles are available, [No title bar] and [With title bar].</p> <p>Window no. Set the pop-up window number.</p>
Animation	<p>Effect Transition effects for</p> <ul style="list-style-type: none"> ● Opening popup windows using Function Keys. ● Opening or closing Direct or Indirect windows. <p>The effects are: Fade, Fly, and Float:</p> <div style="display: flex; justify-content: space-around; align-items: center;"> <div style="text-align: center;">  <p>Fade</p> </div> <div style="text-align: center;">  <p>Fly</p> </div> <div style="text-align: center;">  <p>Float</p> </div> </div> <p>Different effects may be used for Start (window appears) and End (window disappears).</p> <p>Duration Specifies how many milliseconds (ms) a transition effect takes to complete.</p> <p>Direction The direction of the transition.</p>
Auto. adjust window size	Automatically resizes the Direct Window and align the pop-up window to the preset region.
	<p>Alignment Sets a reference point of the pop-up window from one of the five positions on the screen. For example, if the lower-right region is selected, the lower-right corner of the pop-up window is aligned to the lower-right region of the Direct Window. See Example 1.</p>

Example 1

Create window no. 11 which can be controlled by a Toggle Switch with address LB-0.

1. Create a Direct Window object and set read address to LB-0.
2. In this example, the reference point for alignment is set to the lower-right region.

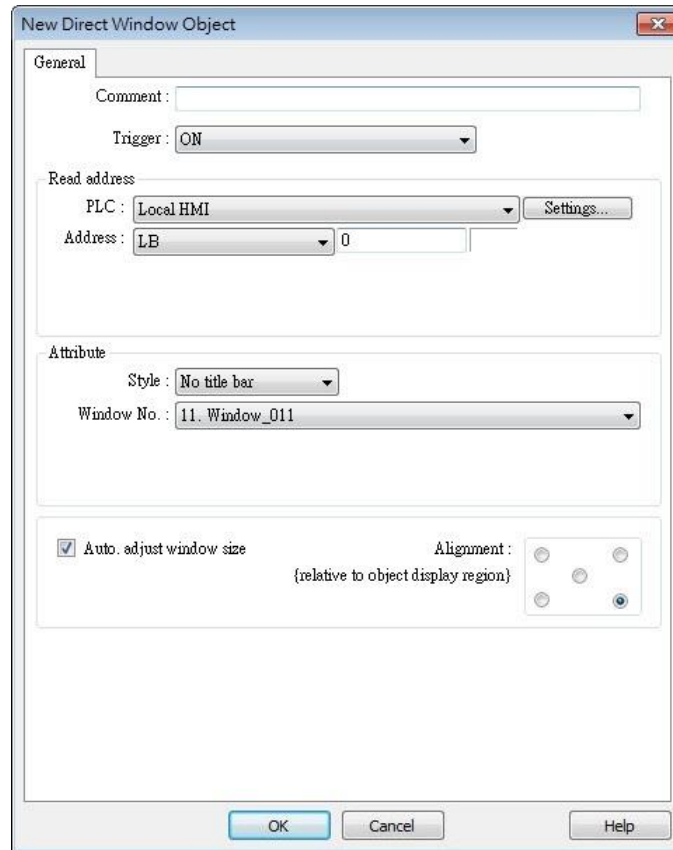

3. When LB-0's state is ON, window no. 11 will show.

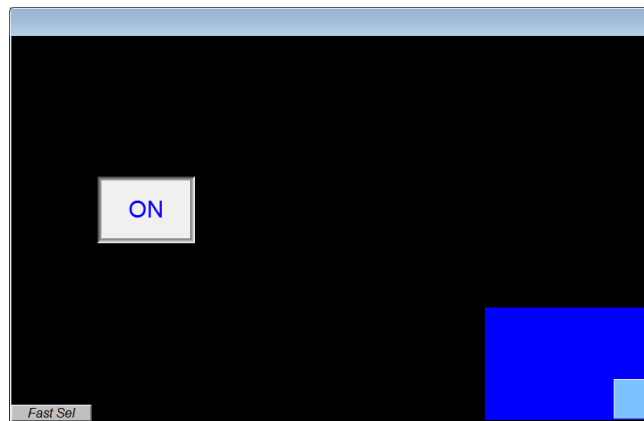

4. When LB-0's state is OFF, window no. 11 will be hidden.

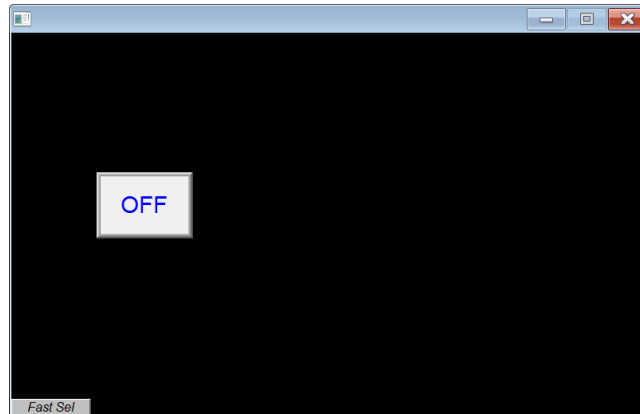
 **Note**

- A screen can simultaneously display up to 24 pop-up windows including System Message Window, Direct Window and Indirect Window.
- The system does not allow opening the same window with two Direct (or Indirect) Windows in one base window.
- If the pop up window has monopoly property enabled, then when the window pops up, all background windows may not be operated until the monopolizing window has been closed.

13.13. Moving Shape

13.13.1. Overview

Moving Shape object defines the states and moving distance of an object. The state and the location of the object depend on consecutive registers.

13.13.2. Configuration



Click the Moving Shape icon on the toolbar to create a Moving Shape object. Set up the properties, press OK button, and a new Moving Shape object will be created.

General Tab

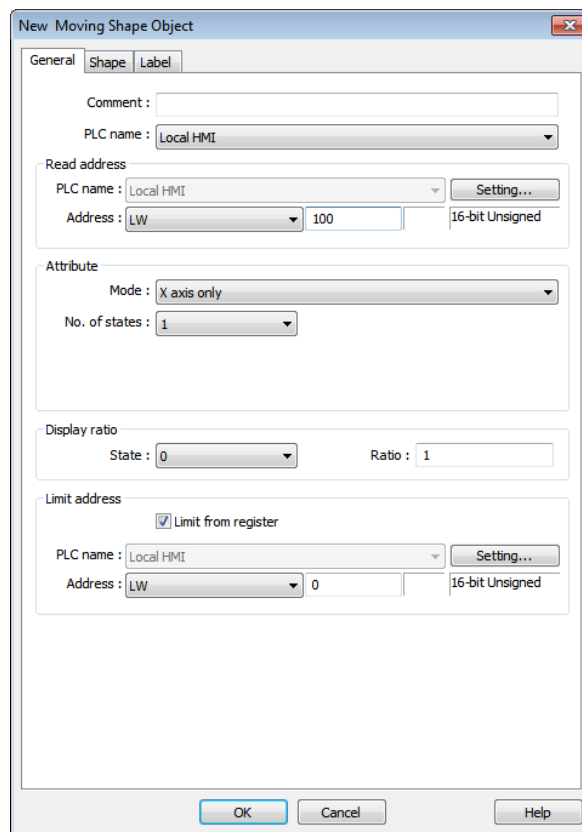

Setting	Description
Read address	Click [Setting] to configure the [PLC name], [Device type], [Address], [System tag], or [Index register] of the word devices that control the display of object's state and moving distance. Users can

	also set the address in [General] tab while adding a new object.
Attribute	Select the object's movement mode and range. See "13.13.2.1 Illustration of Modes" in the following part.
Display ratio	The size of shape in different states can be set individually as shown in the following figure. <div style="text-align: center;"> </div>
Limit address	The object's moving range can be set by adjusting the data in the designated register, see Example 1.

Example 1

Supposed that the object's moving range is limited by register LW-n, the addresses in the following table are used to limit the moving range.

Data format	16-bit	32-bit
[Min. X] address	LW-n	LW-n
[Max. X] address	LW-n+1	LW-n+2
[Min. Y] address	LW-n+2	LW-n+4
[Mas. Y] address	LW-n+3	LW-n+6

13.13.2.1. Illustration of Modes

Available modes are: (Assume Read Address is LW-n)

- X axis only

The object is only allowed to move along the X-axis. The moving distance ranges from [Min. X] to [Max. X].

Attribute

Mode : X axis only

No. of states : 8

Min. X : 0 Max. X : 600

Data format	16-bit	32-bit
Object state	LW-n	LW-n
Moving distance on X-axis	LW-n+1	LW-n+2

- Y axis only

The object is only allowed to move along the Y-axis. The moving distance ranges from [Min. Y] to [Max. Y].

Attribute

Mode : Y axis only

No. of states : 8

Min. Y : 0 Max. Y : 480

Data format	16-bit	32-bit
Object state	LW-n	LW-n
Moving distance on Y-axis	LW-n+1	LW-n+2

● X & Y axis

The object is allowed to move along the X-axis and Y-axis. The moving range in X and Y directions is defined by [Min. X], [Max. X] and [Min. Y], [Max. Y] respectively.

Attribute

Mode : X & Y axis

No. of states : 8

Min. X : 0 Max. X : 600

Min. Y : 0 Max. Y : 480

Data format	16-bit	32-bit
Object state	LW-n	LW-n
Moving distance on X-axis	LW-n+1	LW-n+2
Moving distance on Y-axis	LW-n+2	LW-n+4

For example, if the object’s read address is LW-100 and the data format is [16-bit Unsigned], LW-100 is used to control the object’s state, LW-101 is used to control the object’s moving distance on the X-axis, and LW-102 is used to control the object’s moving distance on the Y-axis. The following figure shows that the object’s read address is LW-100 and initial position is (100, 50). To move the object to the position (160,180) and change its state to State 2, assign 2 to LW-100, 160-100 = 60 to LW-101, 180-50 = 130 to [LW102].

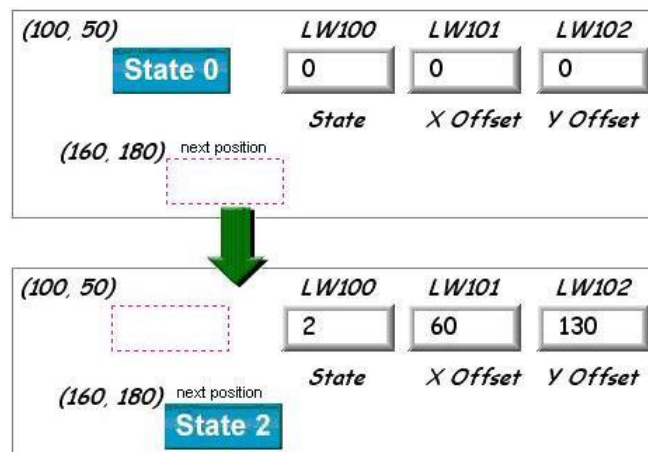

- X axis w/ scaling

The object moves in X-axis only with scaling. Suppose that the value of the designated register is DATA, the system uses the following equation to calculate the moving distance on the X-axis.

$$\text{Displacement} = (\text{Data} - [\text{Input low}]) \times \frac{[\text{Scaling high}] - [\text{Scaling low}]}{[\text{Input high}] - [\text{Input low}]}$$

Data format	16-bit	32-bit
Object state	LW-n	LW-n
Moving distance on X-axis	LW-n+1	LW-n+2

- Y axis w/ scaling

The object is for Y axis movement with scale, and the equation to calculate the moving distance on the Y-axis is the same as the one in [X axis w/ scaling].

Data format	16-bit	32-bit
Object state	LW-n	LW-n
Moving distance on Y-axis	LW-n+1	LW-n+2

- X axis w/ reverse scaling

This works in the way as [X axis w/ scaling], but the moving direction is in reverse.

- Y axis w/ reverse scaling

This works in the way as [Y axis w/ scaling], but the moving direction is in reverse.

13.14. Animation

13.14.1. Overview

Animation object is defined by a pre-defined point set and states. Animation object will then move to a given point in a given state defined by designated registers. The object state and position depend on current value of two consecutive registers. The first register controls the state of the object and the second register controls the position along the predefined path.

13.14.2. Configuration



Click the Animation icon on the toolbar. First, create the pre-defined path. Move the mouse to each moving position, and click the left button to define positions one by one. When it is done, right click on the screen, set up the properties, press OK button, and a new Animation object will be created.



To change the object's attributes, double click on the object to open Animation Object's Properties dialog box.

General Tab

Setting

Description

Attribute

No. of states

Configure the number of states for this object.

Controlled by register

Use the designated registers to control the object's state and position. See Example 1.

Based upon time interval

The object's state and position will change from time to time. [Time interval attributes] is used to set the time interval for states and positions.

Position speed: The speed of movement. The unit is 0.1 second.

Supposed that [Speed] is set to 10, the object's position will change each second.

Image state change: Determines how state changes, either [Position dependent] or [Time-based]. If [Position dependent] is selected, the object state will change when position changes. If [Time-based] is selected, the object position will change based on [Position speed] and the object state will change based on [Image update time].

Backward cycle: Assumed the object has four positions: position 0, position 1, position 2, and position 3, and [Backward cycle] is not selected. When the object moves to the last position (position 3), the next position will be back to the initial position 0, and repeat. The moving path is shown as follows:

position 0 → position 1 → position 2 → position 3 → position 0 → position 1 → position 2...

If [Backward cycle] is selected, when the object moves to the last position (position 3), it will move backwards to position 2, position 1 and then the initial position 0, and start over again. The moving path is shown as follows.

position 0 → position 1 → position 2 → position 3 → position 2 → position 1 → position 0...

Example 1

The object’s state and position are determined by the registers, and the addresses must be configured correctly, as in the following table:

Data format	16-bit	32-bit
Object state	LW-n	LW-n
Object position	LW-n+1	LW-n+2

For example, if the designated register is LW-100 and the data format is [16-bit Unsigned], then LW-100 represents object’s state, LW-101 represents position. In the picture below, LW-100 = 2, LW-101 = 3, so the object’s state is 2 and position is 3.

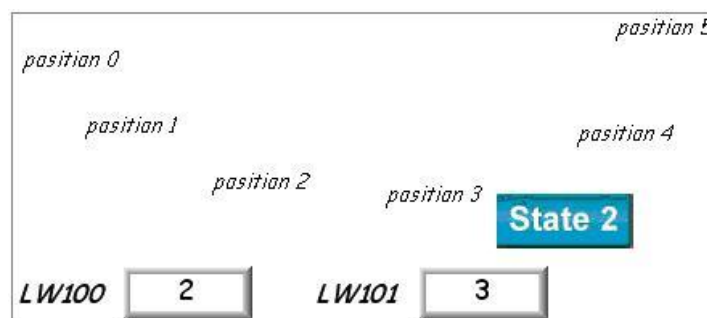

Profile Tab

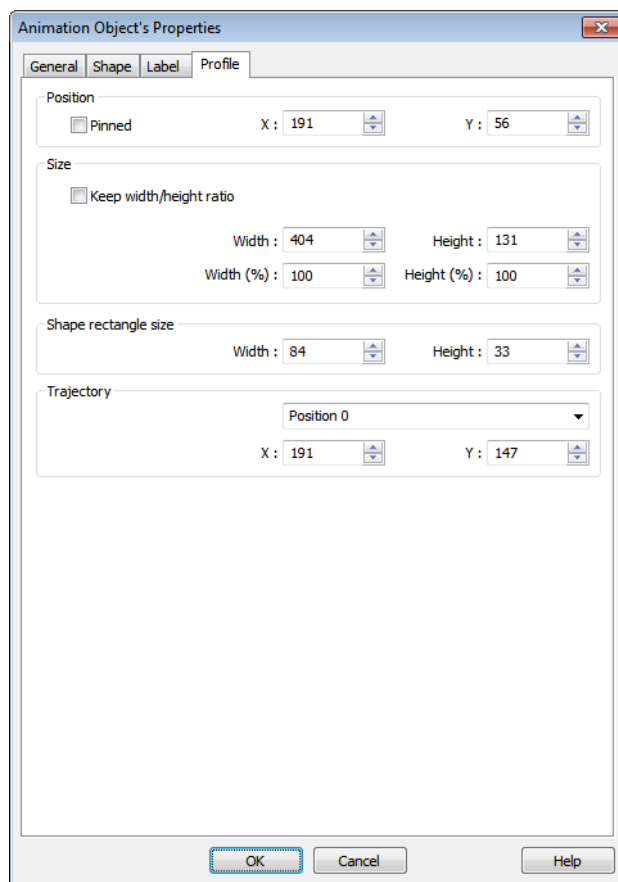

Setting	Description
Shape rectangle size	Set the size of the shape.
Trajectory	Set the position of each point on the moving path.

 Note

- Since multiple pictures might be used by an [Animation] object, [Set to original dimension] will not return all pictures to the original size.

13.15. Bar Graph

13.15.1. Overview

Bar Graph object displays data as a bar graph for visualization.

13.15.2. Configuration



Click Bar Graph icon on the toolbar to open Bar Graph dialog box. Select properties, click OK button, a new Bar Graph object is created.

General Tab

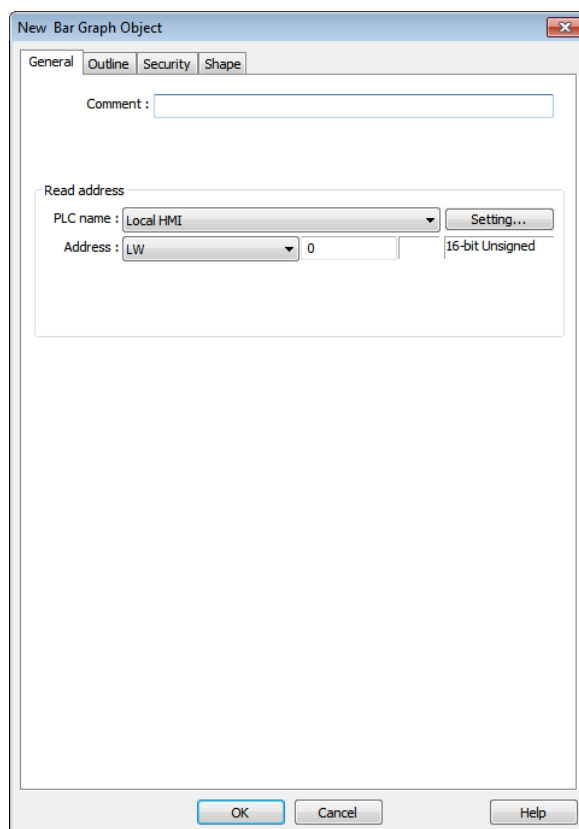

Setting	Description
Read address	Click [Setting] to Select the [PLC name], [Device type], [Address], [System tag], and [Index register] of the word devices that controls how the bar graph displays.

Outline Tab

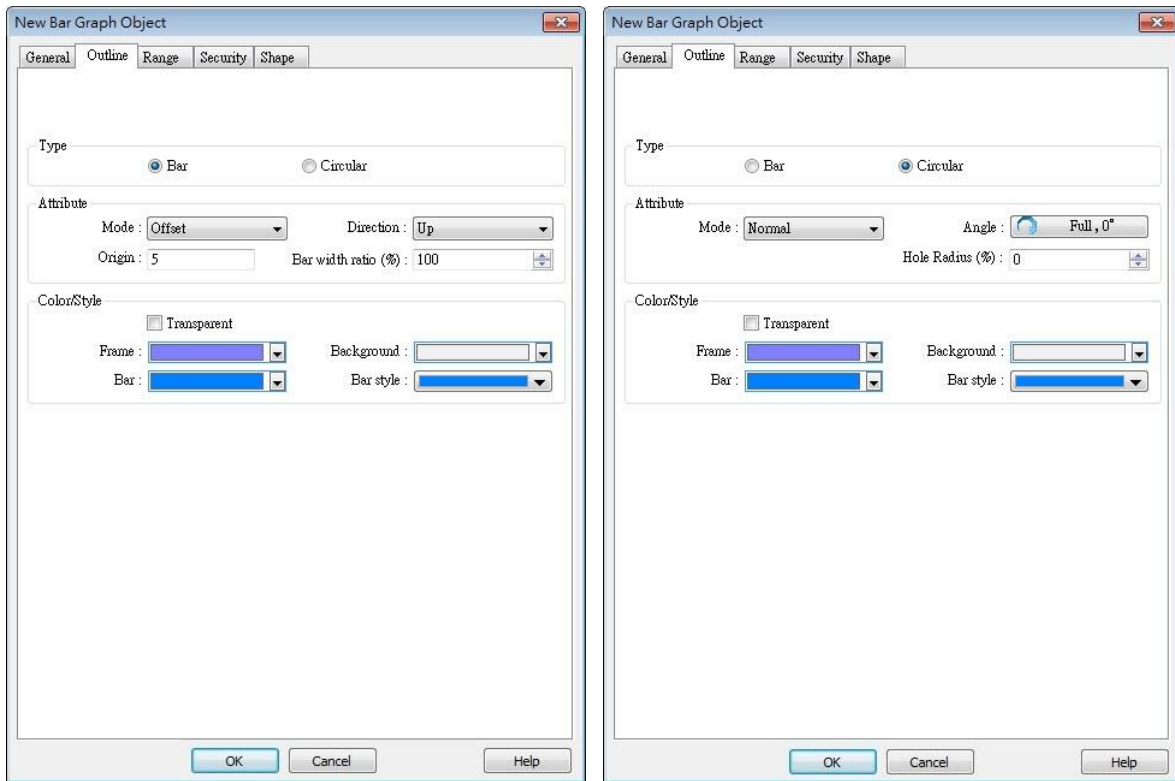

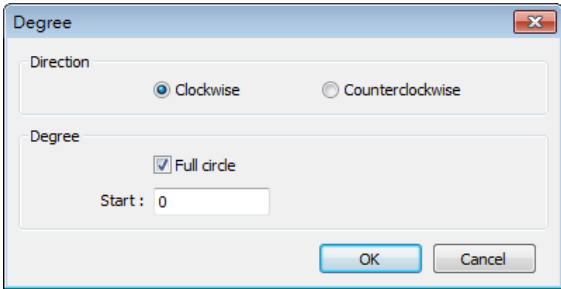
Setting	Description
Type	Choose either [Bar] or [Circular].
Attribute	<p>Mode Choose either [Normal] or [Offset]. If [Offset] is selected, an original value [Origin] must be entered for reference.</p> <p>Direction / Degree Bar: Determine the bar graph direction. Available options are [Up], [Down], [Right], and [Left]. Circular: Determine the circular bar graph direction. Available options are [Clockwise] and [Counter clockwise].</p>  <p>If [Full circle] is selected, set the start degree. If [Full circle] is not selected, set the start and end degree.</p> <p>Bar width ratio (%)</p>

The ratio of bar to object width. The figure below shows two ratios, 100% and 50%.

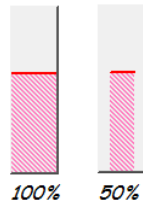

Hole Radius (%)

The ratio of the radius of the hole to the radius of the whole circular bar graph. The figure below shows two ratios, 0% and 50%.

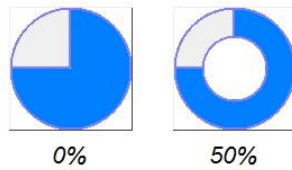

Color/Style

Set the bar's frame and background color, bar style, and bar color. See the picture below.

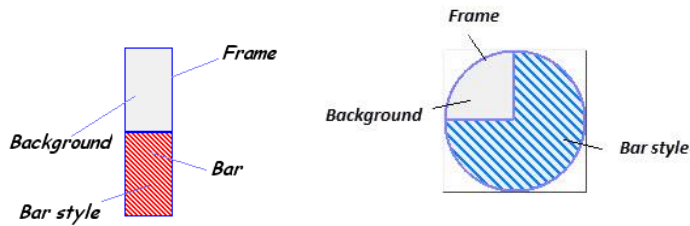

Range Tab

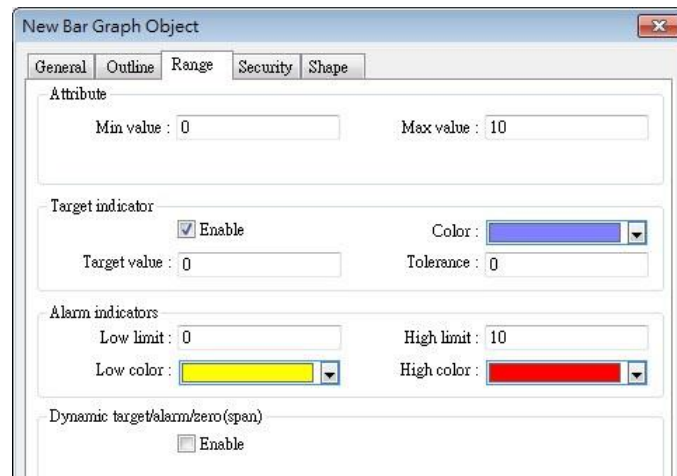

Setting

Description

Zero / Span

The percentage of filling can be calculated by the formula, see Example 1.

Target indicator	When the register value meets the condition, the color of filled area will change to the target color, see Example 2.
Alarm indicators	If the register value is larger than [High limit], the color of filled area will change to [High color]. If the register value is smaller than [Low limit], the color will change to [Low color].
Dynamic target/alarm /zero(span)	When [Enable] is selected, the [Low limit] and [High limit] of [Alarm indicator] and the [Target Value] of [Target indicator] will use designated registers, which is shown in their respective fields see Example 3.

Example 1

The percentage of filling can be calculated by the following formula:

$$\text{Percentage of filling} = \frac{\text{Register value} - [\text{Zero}]}{[\text{Span}] - [\text{Zero}]} \times 100\%$$

Assume [Offset] is selected. If (Register value – [Zero]) is greater than 0, the bar will fill up from [Origin]. If (Register value – Zero) is less than 0, the bar will be drawn below [Origin].

For example, [Origin] is 5, [Span] is 10, and [Zero] is 0.

For different value in read address, it will display as below:

If the value at read address is 4:

If the value at read address is 8:

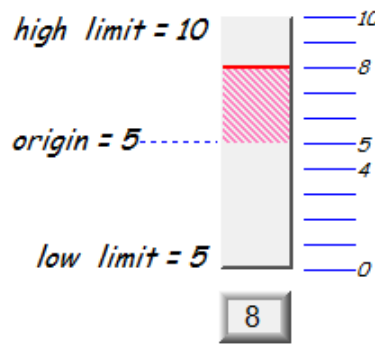
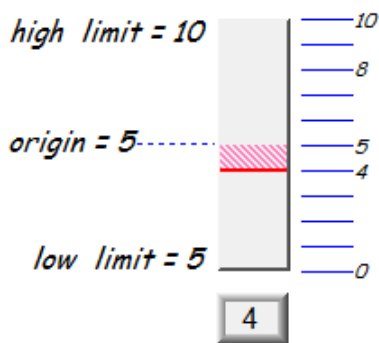

Example 2

When the register value meets the following condition, the color of filled area will change to the target color.

$$[\text{Target Value}] - [\text{Tolerance}] \leq \text{Register value} \leq [\text{Target Value}] + [\text{Tolerance}]$$

Assume [Target Value] is 5 and [Tolerance] is 1. As shown below, if the register value is equal to or larger than 4 (=5-1) and equal to or less than 6 (=5+1), the filled area's color of the bar will change to the target color.

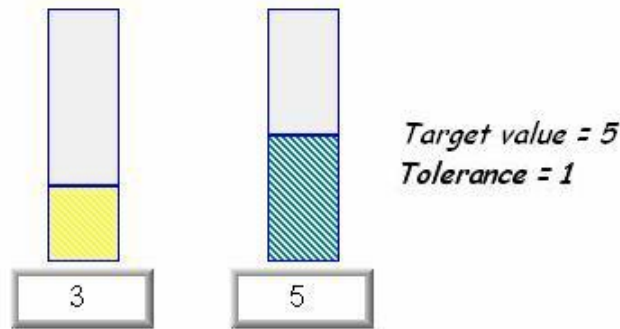

Example 3

If [Dynamic target/alarm] is enabled, [Low limit] and [High limit] of [Alarm indicator] are defined by designated registers as shown in the following table. Furthermore, if [Dynamic zero/span] is used, [Zero], [Span] and [Origin] will be defined by designated registers. Assume the address is LW-n, the limits are:

Data format	16-bit	32-bit
Alarm Low Limit	LW-n	LW-n
Alarm High Limit	LW-n+1	LW-n+2
Target	LW-n+2	LW-n+4
Zero	LW-n+3	LW-n+6
Span	LW-n+4	LW-n+8
Origin	LW-n+5	LW-n+10

13.15.3. Combo Setting

cMT Series HMI support combo setting for Bar Graph, which allows setting of multiple related objects at a time. Bar Graph can be set with Background and Dynamic Scale.

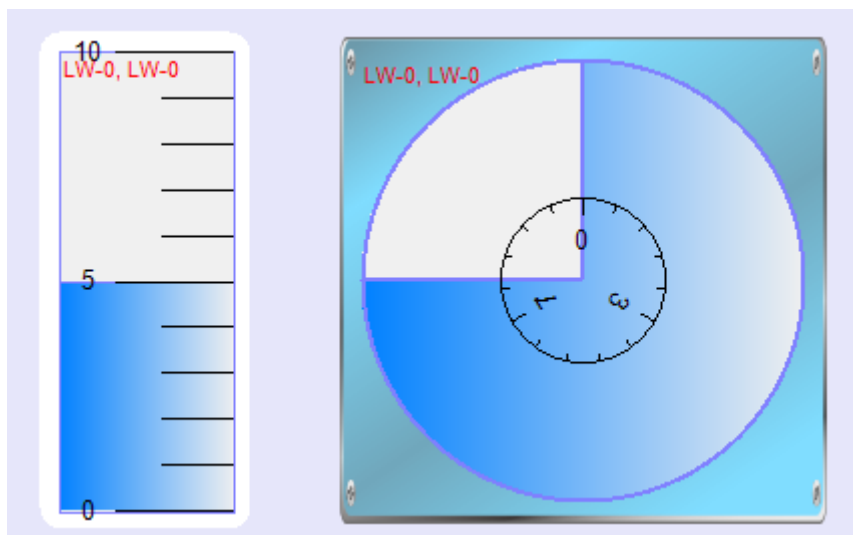

Background

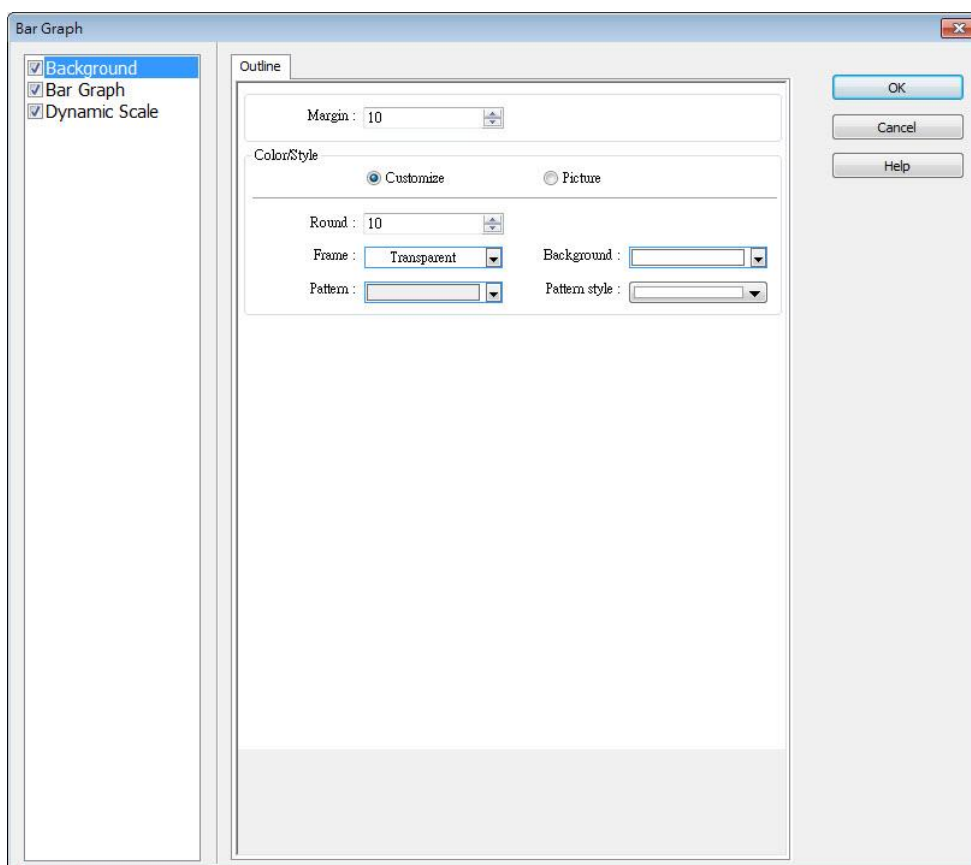

Setting	Description
Margin	Specify the space between the background edge and the objects.
Color/Style	Customize

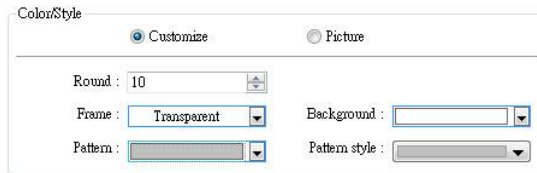

Select a suitable background pattern and color.

Picture



Use the default picture or choose a picture from Picture Library.

Dynamic Scale

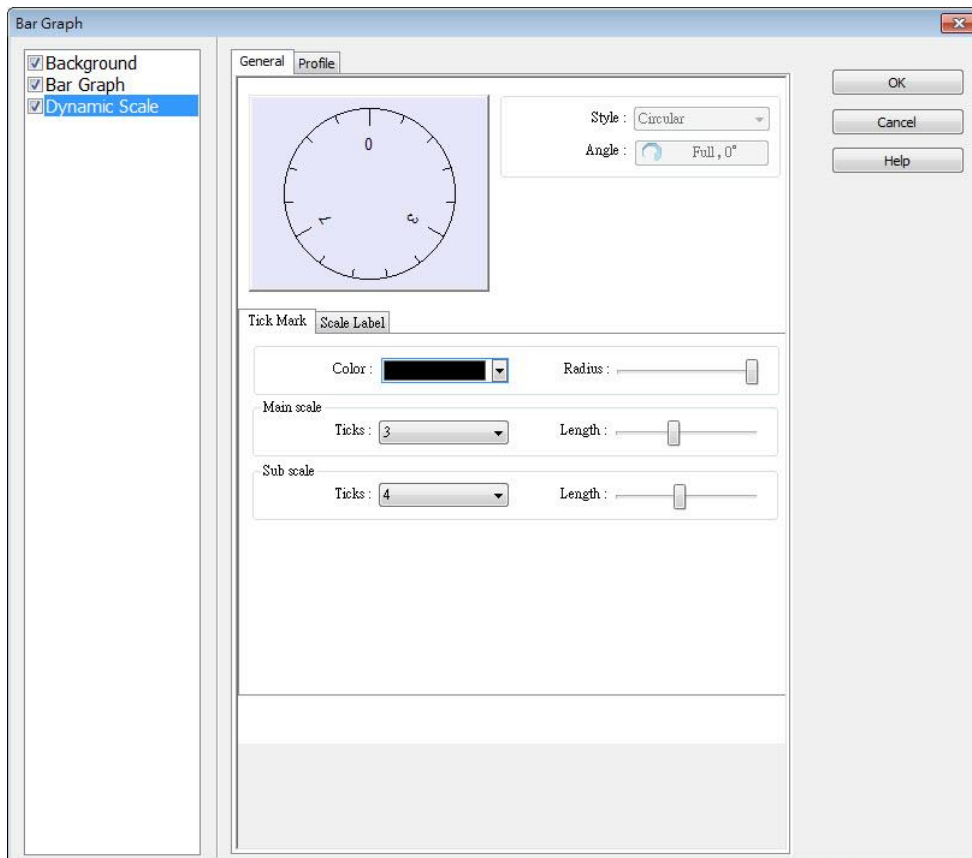

Setting	Description
Style	The scale style will follow the bar type.
Tick Mark	Configure the number of tick marks for main and

	sub scales. If the style is circular, the radius and tick mark length can be specified.
Scale Label	Configure the font, font color, font size and other attributes of scale label.

13.16. Meter Display

13.16.1. Overview

Meter Display object displays the value of word register with a meter.

13.16.2. Configuration



Click the Meter Display icon on the toolbar to open the Meter Display dialog box. Set the object's attributes and then click OK to create a new Meter Display object.

13.16.2.1. eMT, iE, XE, mTV Series

General Tab

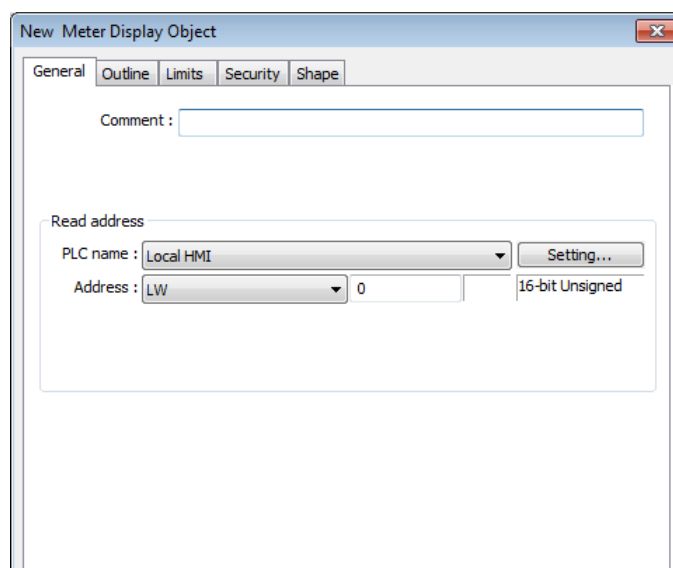

Setting	Description
Read address	Click [Setting] to select the [PLC name], [Device type], [Address], [System tag], and [Index register] of the word devices that controls the Meter Display object.

Outline Tab

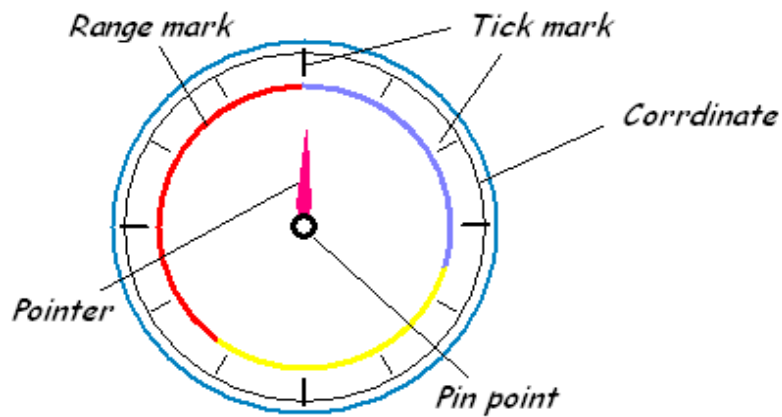
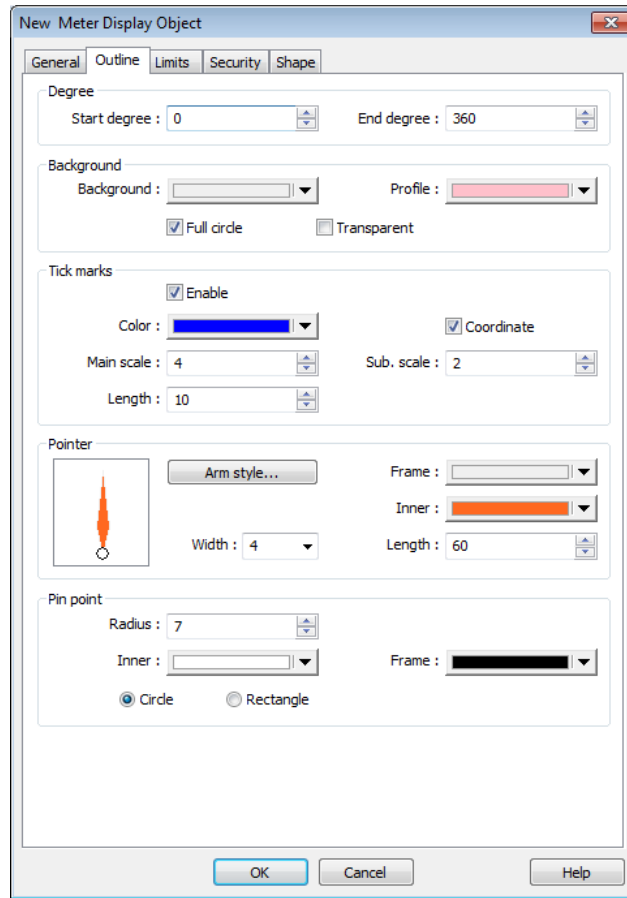

Setting	Description
Degree	Sets the object's start degree and end degree measured clockwise from the 12 o'clock position. The angle range is 0 to 360 degrees. The following shows meters of different settings.

- [Start degree] = 290°
[End degree] = 70°

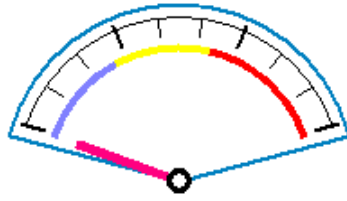

- [Start degree] = 120°
[End degree] = 240°

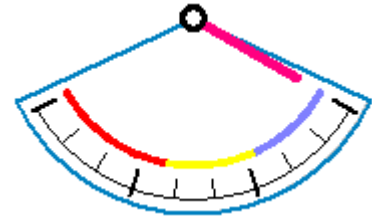

- [Start degree] = 40°
[End degree] = 140°

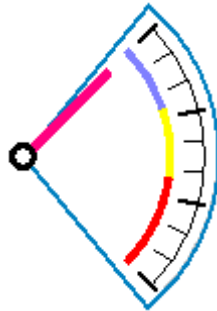

- [Start degree] = 225°
[End degree] = 315°

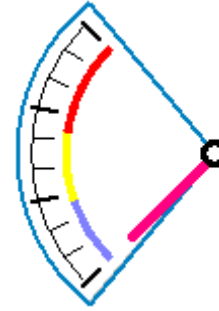

Background

Sets the object's background color and profile color.

Full circle

When selected, the object will display the whole circle. Otherwise, the object will only display a partial circle in the defined degree range, as shown in the following figure.

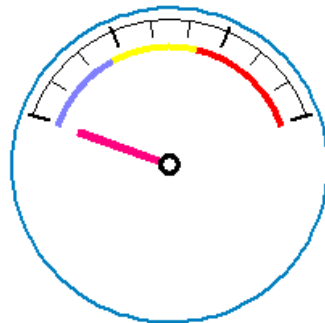

Full circle

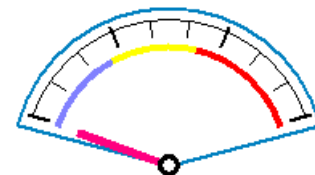

non-full circle

Transparent

When selected, the object will not display the background and profile color.

Tick marks

Configures the number of tick mark and color.

Pointer

Configures pointer's style, length, width, and color.

Pin point

Configures the style, radius, and color of the pin point.

Limits Tab

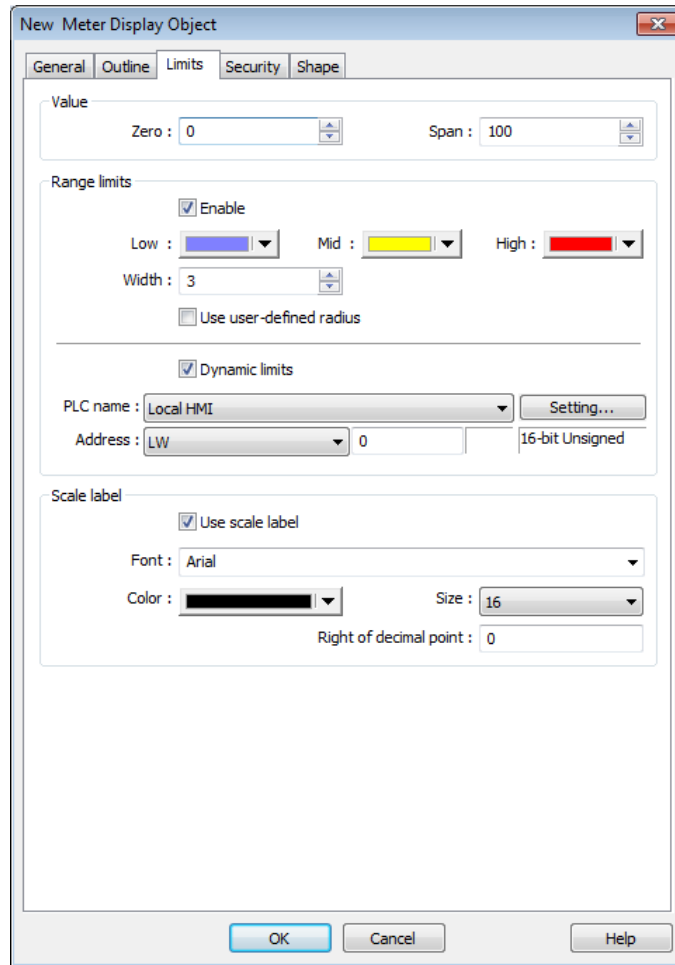

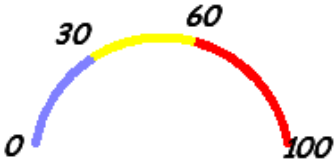
Setting	Description
Value	Sets the object's display range. Meter Display object will use the value of [Zero] and [Span] and the value of register to calculate the pointer's position. See Example 1.
Range limits	Configures the values of [Low limit], [High limit], their corresponding display colors, and the width. 
Use user-defined radius	Configures the radius to display range limits. For example, set to 80: Set to 30:

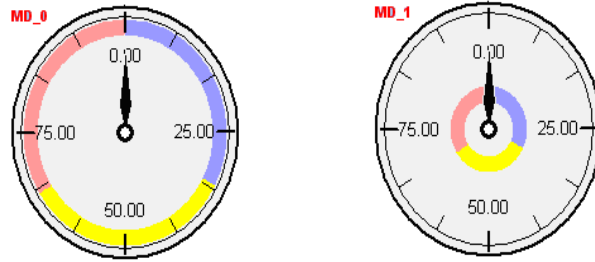

Dynamic Limits

The low limit and high limit are set by registers. See Example 2.

Scale label

Select the attribute of scale label on Meter Display.

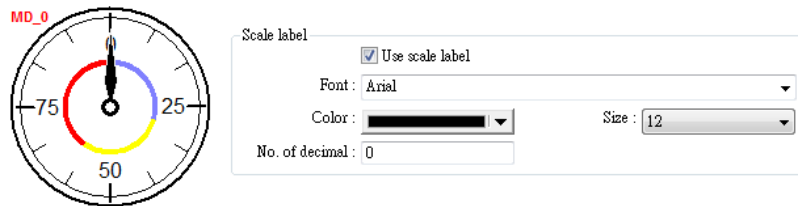

Example 1: Pointer position calculation

Set object’s display range. Meter Display object will use the value of [Zero] and [Span] and the value of register to calculate the pointer’s position. For example, supposed that [Zero] is 0, [Span] is 100, when the value of register is 30, [Start degree] is 0, and [End degree] is 360, then the degree indicated by the pointer is:

$$\{ (30 - [Zero]) / ([Span] - [Zero]) \} * ([End degree] - [Start degree]) = \{(30 - 0) / (100 - 0)\} * (360 - 0) = 108$$

Pointer will be pointing at 108 degrees.

Example 2: Dynamic Limits

The low limit and high limit are set by the register.

Suppose the address is LW-n, the following table shows the read address of low limit and high limit:

Content	16-bit	32-bit
Low limit	LW-n	LW-n
High limit	LW-n+1	LW-n+2

For instance, when address is LW-100, the rule of setting limits is:

Content	16-bit	32-bit
Low limit	LW-100	LW-100
High limit	LW-101	LW-102

13.16.2.2. cMT Series

General Tab

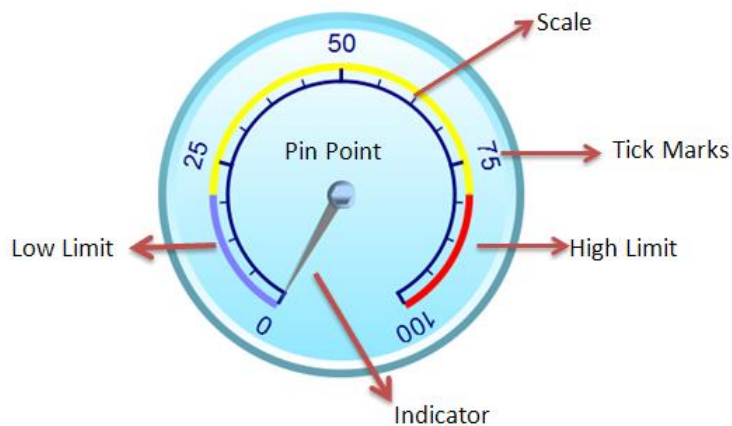
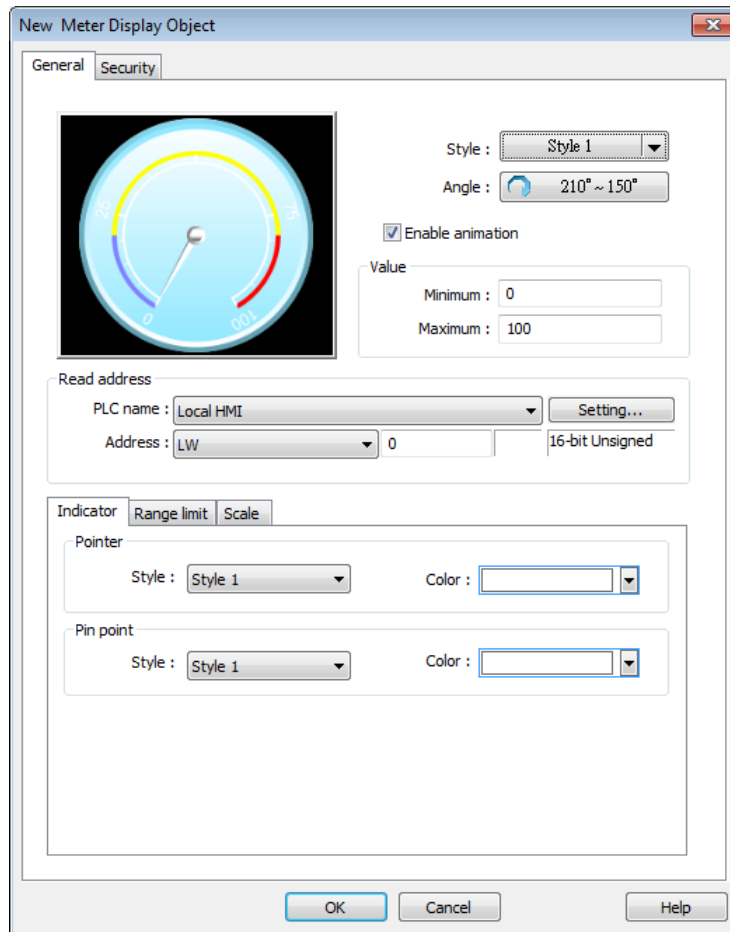

Setting	Description
Style	Three options are available: [Custom], [Style 1], and [Style 2]. Click on the text to configure the properties. If [Custom] is selected, set the properties such as [Pointer], [Pin point], [Background picture], etc.

Setting

Click the button of [Style 1] or [Style 2] to set the style of meter.

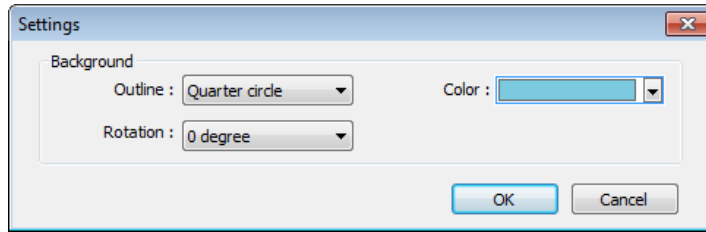

Outline

The following is the outline of Style 1 when [Full circle], [Half circle], or [Quarter circle] is selected.

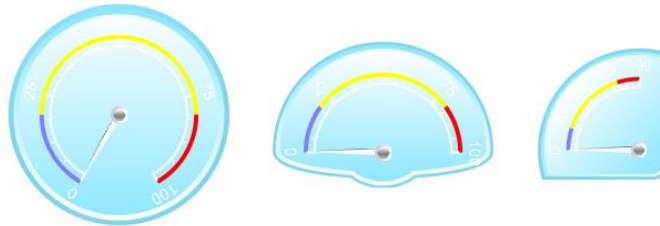

The following is the outline of Style 2 when [Full circle], [Half circle], or [Quarter circle] is selected.



Rotation

Rotates the background picture clockwise according to the angles set.

Color

Sets the color of the background picture of meter.

Angle

Sets the range to label the scale, 0° to 360° clockwise or counterclockwise from the twelve o'clock position.

Full circle

If selected, the full circle is drawn according to the selected direction and the start angle. The limits are determined by the value set in [Minimum] and [Maximum] field under [Value].

Enable animation

If selected, the pointer slides to the designated position when the read value changes; if not selected, the pointer directly points to the designated position when the read value changes.

Value

Sets the lower and upper limits of the meter.

Read address

Displays the value in meter according to the value in the designated word register.

Indicator

Sets the style of pointer and pin point. If [Custom] is selected, the direction of the pointer must points upward to correctly display.

Range limit	Sets the colors to indicate different ranges. Dynamic limits The low limit and high limit are decided by the register. See Example 2 above.
Scale	Sets the number of main and sub scale, the color of tick marks and scale label.

13.17. Trend Display

13.17.1. Overview

Trend display objects draw curves of the data recorded by Data Sampling object.

13.17.2. Configuration







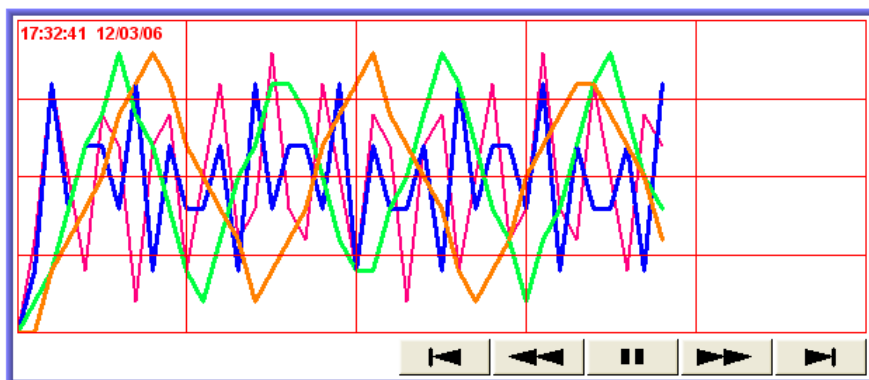

Click the Trend Display icon on the toolbar to open a Trend Display object property dialog box. Set up the properties, press OK button, and a new Trend Display object will be created.

13.17.2.1. eMT, iE, XE, mTV Series

General Tab



Button	Description
	Go to the earliest sampling data.
	Go to the previous time interval.
	Click to stop auto-scrolling. When the new sampling data is generated, the display does not scroll, nor is the new data outside the display range displayed.
	Click to start auto-scrolling. The display scrolls as the new sampling data is generated.
	Go to the next time interval.
	Go to the latest sampling data.

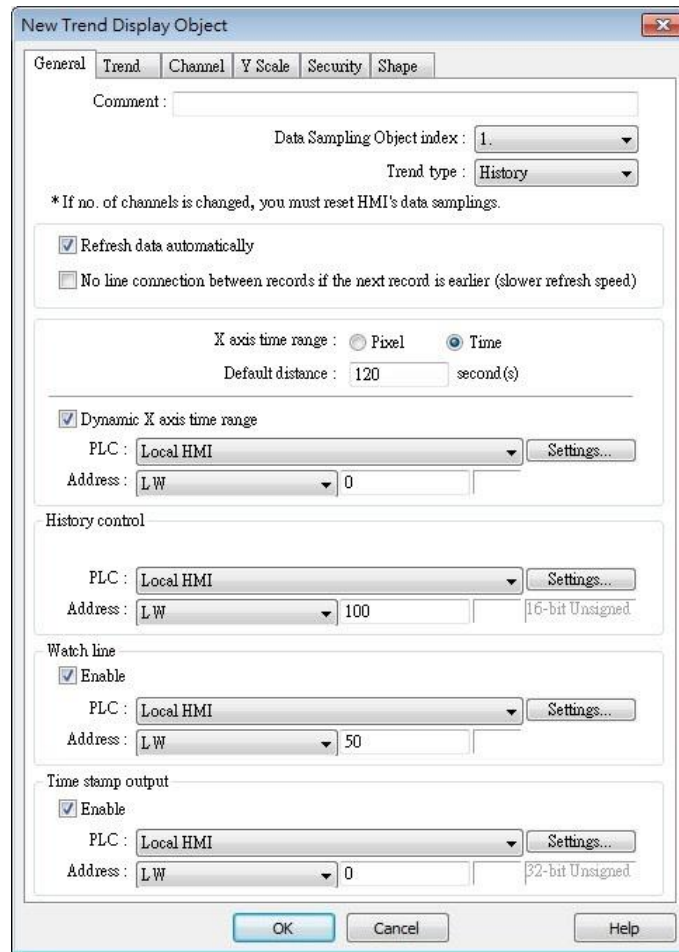

Setting	Description
Data Sampling Object index	Select a Data Sampling object as the source data.
Refresh data automatically	In history mode, when this option is selected, Trend Display will be automatically refreshed every 10 seconds. If this option is not selected, Trend Display can only be refreshed by changing window.
No line connection between records if the next record is earlier	When HMI time is adjusted to an earlier time, and data sampling keeps going on, selecting this option can prevent the system from drawing a line to connect the gap between current trend curve (earlier in time axis) and former trend curve (later in time axis). This can slow down refresh speed.
Trend type	Select the mode of data source, either [Real-time] or [History]. Real-time In this mode, the display object shows all sampled data since the HMI started. The maximum number of records that can be sampled is set in [Max.data records] (Real-time mode) of the Data Sampling object. When the sampling data exceed this setting, the earlier

data will be deleted. To show older data, use [History] mode.

[Hold control]: Suspends the update of Trend Display. However, It does not stop the sampling process of Data Sampling object.

History

In this mode, the data comes from the history data files stored on HMI. . The history data files are sorted by dates and each is given an index. The system uses [History control] to select the history data files that are created on different dates.

The system sorts the history data of sampling data by date; the latest file is record 0 (typically the data sampled today), the second latest file is record 1, and so on. If the value of designated register in [History control] is n, the Trend Display object will display data record n.

Here is an example to explain [History control]. If the designated register is LW-0, and the sampling data files available are pressure_20061120.dtl, pressure_20061123.dtl, pressure_20061127.dtl, and pressure_20061203.dtl, and it is 2006/12/3 today, based on the value of LW-0, the sampling data file which will be selected by [Trend Display] is shown as follows:

Value of LW-0	Selected sampling history data
0	pressure_20061203.dtl
1	pressure_20061127.dtl
2	pressure_20061123.dtl
3	pressure_20061120.dtl

If use with Option List object and select data source as [Dates of historical data], the history data will be sorted by date and displayed in Option List object, see “13.29 Option List”.

Pixel

[Distance] is used to set the distance between two sampling points, as shown in the following figure.

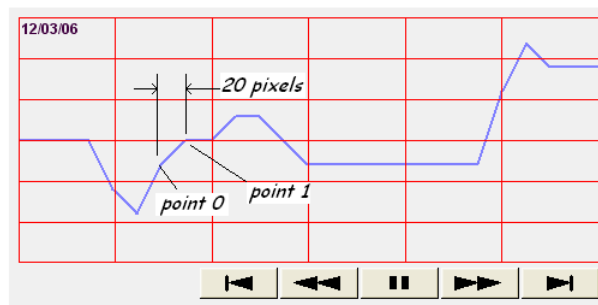

Time

[Distance] is used to set the X-axis in unit of time, as shown in the following figure.

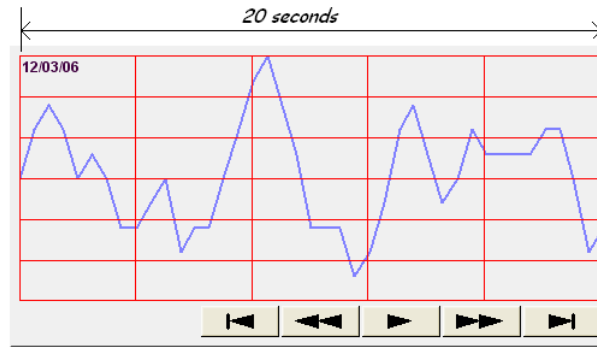





Select [Time] for [X axis time range] and go to [Trend] » [Grid] and enable [Time scale]. Please refer to [Time scale] in the later section.

**Dynamic distance between data samples/
Dynamic X axis time range**

Designate a 32-bit word register for adjusting the distance between two sampling points (select Pixel), or the time unit represented by X-axis (select Time). If no value is entered, the default value will be used.

Refresh data automatically

If selected, every time when opening the window on which the Trend Display object in history mode is placed, the display is automatically refreshed once per second. Please note that:

- The refresh status can be observed from the control button of Trend Display object.
Showing  button: The automatic refresh feature is enabled.
Showing  button: The automatic refresh feature is disabled.
- When scrolling to the previous data, the automatic refresh feature is disabled, the  button is shown.
- If [Refresh data automatically] check box is selected, when change back to the window, the display is refreshed, ignoring the control buttons. For example, select [Refresh data automatically], and scroll to the previous data, the automatic refresh feature is disabled. In this case, changing to another window and then change back will still refresh the display.
- If [Refresh data automatically] check box is not selected when building the project, the feature can still be enabled by pressing  button on HMI. In this case, the automatic refresh feature is disabled, that is, even when change back to the current window, the display will not be refreshed.

Hold control

When the register is set ON, suspend the update of Trend Display. It

does not stop the sampling process of Data Sampling object. This setting is available only in Real-time mode.

Watch line

Use the [Watch line] function to display a “watch line” when user touches the Trend Display object. It will also export the sampling data at the position of watch line to the designated word device and use Numeric objects to display the results, as shown in the following figure.

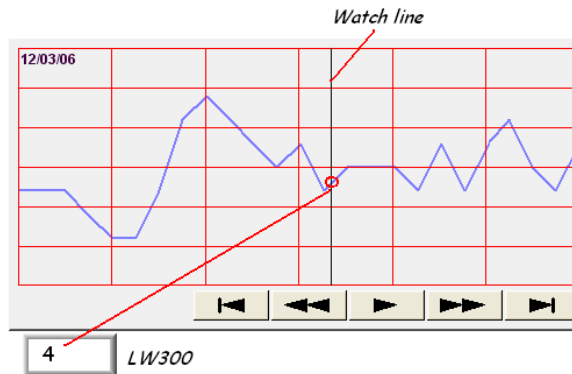

[Watch line] can also export sampling data with multiple channels. The system will consecutively write each channel to the specified address and the following addresses, in the same order as in [Data Sampling] object. The address assigned to [Watch line] is the start address, and sampling data for each channel will be exported to the word devices starting from “start address.” If the data format of each channel is different, the corresponding address of each channel is arranged from the first to the last. If the watch register is LW-300, watch function will export each channel’s data to the following addresses:

Register	Channel	Data format
LW-300	0	16-bit Unsigned (1 word)
LW-301	1	32-bit Unsigned (2 words)
LW-303	2	32-bit float (2 words)
LW-305	3	16-bit Signed (1 word)

Time stamp output

Time stamp output

Suppose the address is set to LW-n, then:

If enabled, the system will use the time of the first sampling data as “time origin”, and write the time stamp of the most recent sampled data (relative to “time origin”) to [LW-n+2].

When clicking on the curve, the time stamp of the closest sampled point will be written to [LW-n].

Clear real-time data address (Data Sampling object) will clear the

time origin as well.

Time stamp is recorded in seconds.

Note

- LW-n and LW-n+2 are both in 32-bit format.
- LW-n is for both real-time and history mode, whereas LW-n+2 only applies to real-time mode.
- This function is available upon enabling [relative time mode] in [Trend] tab.

13.17.2.2. cMT Series

General Tab

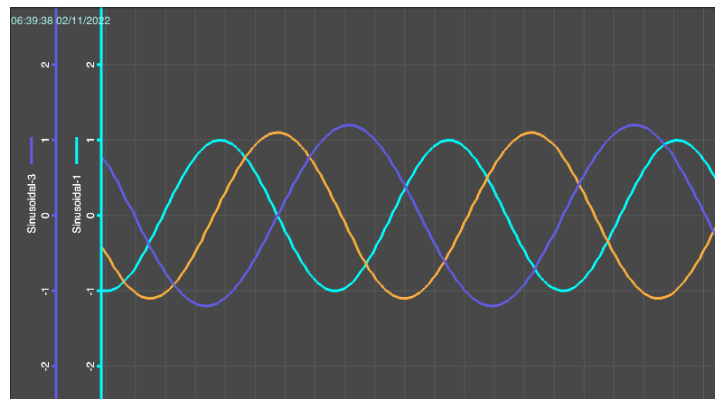

The Trend Display on cMT Series combines Real-time mode and History mode. Drag left to scroll the Trend Display to view history data and drag right to view the latest sampling data. Pinch two fingers together to zoom out Trend Display or spread them apart to zoom in.

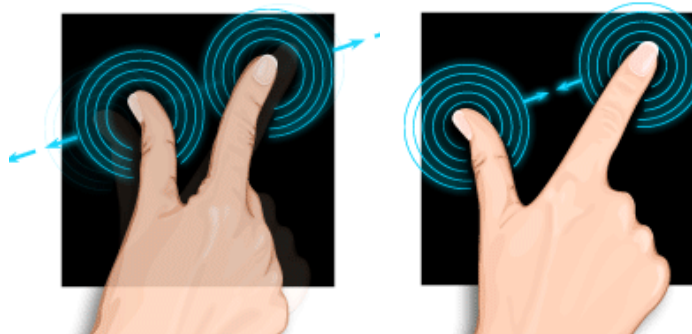

Zoom In

Zoom Out

 For more information about how sampling data is saved, see “8 Data Sampling”.

Setting	Description
Data	
Sampling Object index	Select a [Data Sampling] object as the source data.
Millimeter	See 13.1.2.1.
Time	See 13.1.2.1.
Watch line	See 13.1.2.1.

Trend Tab

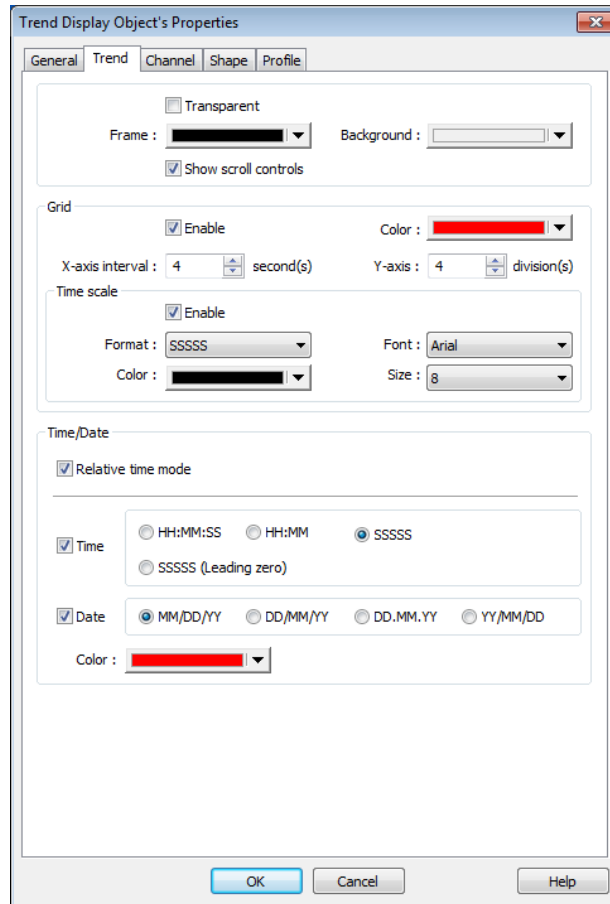

Setting	Description
Frame / Background	Select the color of frame and background.
Show scroll controls	Enable or disable the scroll control as shown in the following figure. 
Grid	Set the number of dividing lines and the line color. The number of divisions depends on the setting in General tab. X-axis interval The number of vertical grid lines. <ul style="list-style-type: none"> Select [Pixel] / [Millimeter] in General tab: Select how many sampling point will be included between two vertical grid lines. Select [Time] in General tab: Select the time range between two vertical grid lines. Y-axis interval The number of horizontal grid lines.

Time scale

Select [Enable] check box to display the time scale along the x axis.

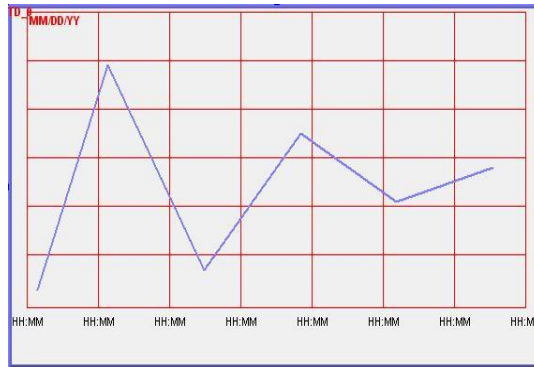

Format

The available time scale formats: HH:MM or HH:MM:SS.

Font / Color / Size

Select the font, font color, and font size of the time scale.

The default font size is 8.

Time / Date

The time of latest sampling data will be marked on the top left corner of the object. This group box is used to set the time display format and font color.

Channel Tab

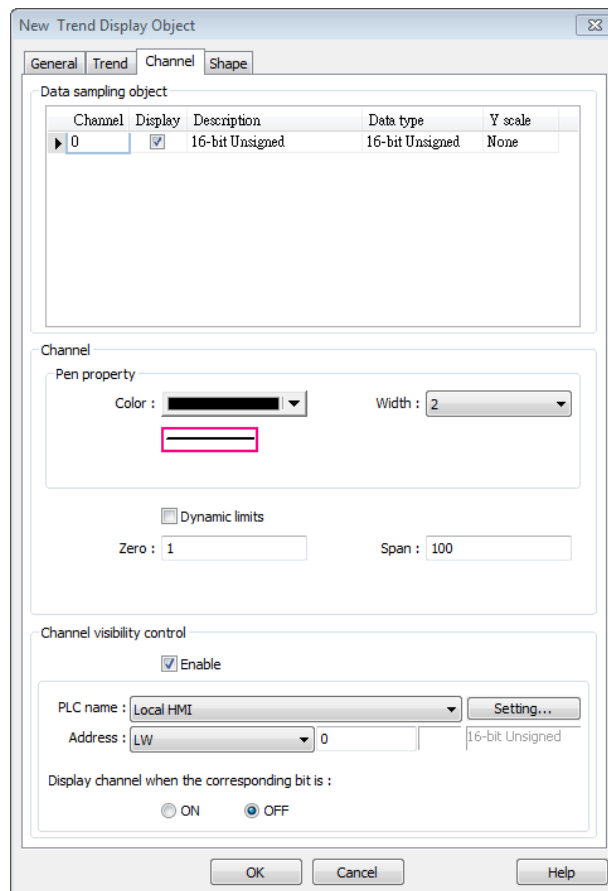

Setting	Description
Y scale	Set Y-axis to be Main Axis or Aux. Axis. See “Y Scale Tab” for more information.

Channel	Display	Description	Data type	Y scale
1	True	channel A	16-bit Unsigned	Aux. Axis
2	True	channel B	16-bit Unsigned	Main Axis
3	True	channel C	16-bit Unsigned	Aux. Axis

Channel Configure each sampling line’s format and color. At most 64 channels could be configured.

Dynamic limits

- Not selected:

[Zero] and [Span] are used to set the low limit and high limit of sampling data. If the low limit is 50 and the high limit is 100 for one sampling line, [Zero] and [Span] must be set as [50] and [100], so that all the sampling data can be displayed in the trend display object.

- Selected

The low limit and the high limit are read from the designated word devices, as shown below. When address is LW-n , the register’s address:

Data Format	16-bit	32-bit
Low limit	LW-n	LW-n
High Limit	LW-n+1	LW-n+2

For example, if LW-100 is used here, the low limit and the high limit will be read from:

Data Format	16-bit	32-bit
Low limit	LW-100	LW-100
High Limit	LW-101	LW-102

A typical usage of this is to zoom in and zoom out of Trend Display. (Not available for cMT Series). See Example 1.

Channel visibility control If [Enable] is selected, the bits of the assigned word register will be used to show/hide each channel. The first bit controls the first channel, and the second bit controls the second channel, and so on. For example, suppose there are 5 channels and LW-0 is used, channels which will be shown given the states of the control bits are:

Channel	Control Bit	State	Displayed
1	LW_bit-000	OFF	YES

2	LW_bit-001	ON	NO
3	LW_bit-002	ON	NO
4	LW_bit-003	OFF	YES
5	LW_bit-004	OFF	YES

Note on using this feature: Each control bits are not reserved for the channel. If a particular channel is not displayed, the control bit is assigned to the next displayed channel. For example, if the third channel of the 5 channels is not displayed, only 4 channels will be displayed in Trend Display, and the used control bits will only be: LW_bit-000~003.

Example 1

The example explains how to zoom in or zoom out Trend Display. The feature described is not available for cMT Series.

In Channel tab select [Dynamic limits] check box. If the [Address] is set to LW-n, then LW-n controls the low limit where LW-n+1 controls the high limit.

Dynamic limits

PLC name: Local HMI Setting...

Address: LW 0 16-bit Unsigned

Set [Address] to LW-0 and create two Numeric objects for entering the low / high limit. The address that controls the low limit is LW-0; the address that controls the high limit is LW-1. Let's suppose the data is between 0 and 30; set the [Low limit] to 0 and the [High limit] to 30, the trend curve is displayed as shown in the following figure.



To zoom out the Trend Display, enter a value greater than 30 in [High limit] as shown in the following figure.

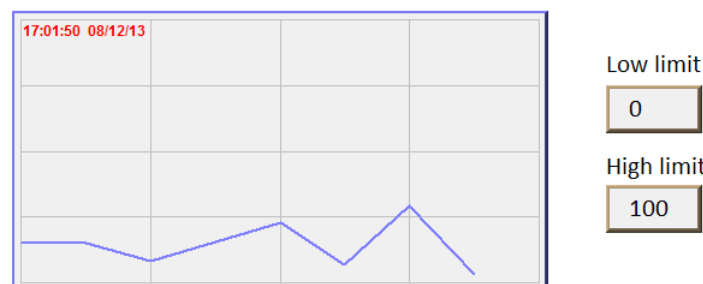

To zoom in the Trend Display, enter a value less than 30 in [High limit] as shown in the following figure.



Y Scale Tab

eMT, iE, XE, mTV Series

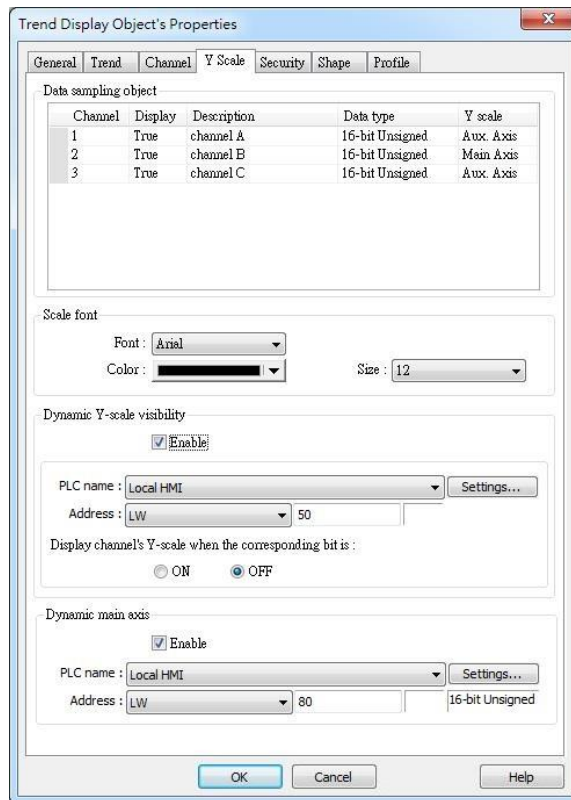

Setting	Description
Y scale	Set Y-axis to be Main Axis or Aux. Axis, or set none to hide Y-axis.
Scale font	Select the font, font color, and font size of the scale.
Dynamic Y-scale visibility	To show or hide Y-scale. If the control address is LW-50, then the first axis is controlled by LW_Bit 5000, and the second axis is controlled by LW_Bit 5001, and so on.
Dynamic main axis	To change the main axis. If writing 1 into LW-80, the main axis will be Channel 1; if writing 2 into LW-80, the main axis will be Channel, and so on.

cMT Series

The scale along the Y axis of a specific channel can be displayed. To enable Y Scale, [Grid] should first be enabled in [Trend] tab. Y Scale can be configured on the iPad as shown in the following steps.

1. Tap the  button on the upper right corner of Trend Display object.
2. Tap [Trend Display Setting] » [Y Scale].

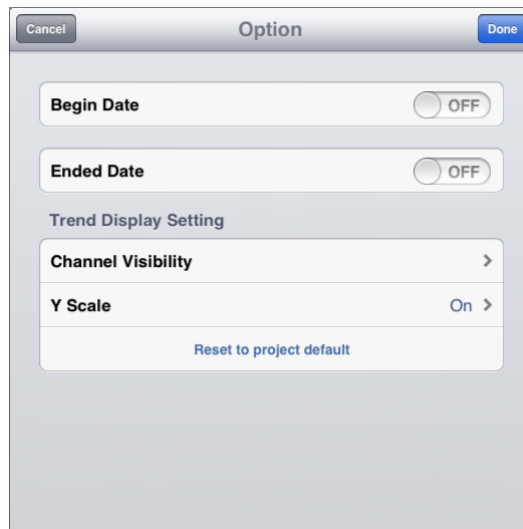

3. Select the channels.



13.18. History Data Display

13.18.1. Overview

History Data Display object displays data stored by Data Sampling object. It differs from Trend Display in that History Data Display object uses a table to display data. The following is an example of a history data display object.

No.	Time	Date	Ch.0	Ch.1	Ch.2
3577	21:52	16/09/07	0	0	0
3576	21:52	16/09/07	0	0	0
3575	21:52	16/09/07	0	0	0
3574	21:52	16/09/07	0	0	0
3573	21:52	16/09/07	0	0	0
3572	21:52	16/09/07	0	0	0
3571	21:52	16/09/07	0	0	0
3570	21:52	16/09/07	0	0	0
3569	21:52	16/09/07	0	0	0
3568	21:52	16/09/07	0	0	0

13.18.2. Configuration

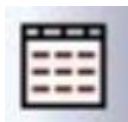

Click the History Data Display icon on the toolbar to open a History Data Display object property dialog box. Set up the properties, press OK button, and a new History Data Display object will be created.

General Tab

Setting	Description
Data Sampling object index	Select a Data Sampling object as the source data.
Refresh Data Automatically	The system will refresh data every 10 seconds. When this option is not selected, data can be refreshed only by changing windows.
Grid	Shows grids between rows and columns. Color Change the color of grids. Column interval Change the width of each column. The figures below are the examples.

No.	Time	Date	Ch.0	Ch.1	Ch.2
3667	21:57	16/09/07	1	0	0
3666	21:57	16/09/07	1	0	0
3665	21:57	16/09/07	1	0	0
3664	21:57	16/09/07	1	0	0
3663	21:57	16/09/07	1	0	0
3662	21:57	16/09/07	1	0	0
3661	21:57	16/09/07	1	0	0
3660	21:56	16/09/07	0	0	0
3659	21:56	16/09/07	0	0	0
3658	21:56	16/09/07	0	0	0

No.	Time	Date			
3667	21:57	16/09/07			
3666	21:57	16/09/07			
3665	21:57	16/09/07			
3664	21:57	16/09/07			
3663	21:57	16/09/07			
3662	21:57	16/09/07			
3661	21:57	16/09/07			
3660	21:56	16/09/07			
3659	21:56	16/09/07			
3658	21:56	16/09/07			

Profile color

Change the color of frame and background. Use [Transparent] to hide frames and background.

Text

Change the font and font size.

Enable or disable showing the time and date and configure its format and color.

Move column [Date] to the front of column [Time]

Swap the position of column [Date] and column [Time].

Time / Date**Sequence no.**

Show the sequence number of all records.

Time ascending

Put earliest data at the top and the latest data at the bottom.

Time descending

Put the latest data at the top and the earliest data at the bottom.

**History Control
(eMT, iE, XE,
mTV Series)**

The history files are sorted by date and each file is given an index.

The latest one is assigned index 0 (in most cases: today), the second latest file is assigned index 1, and so on. [History Control] is used to specify the history data to be shown.

 **Note**

- When using cMT-SVR, use the filter icon in the upper-right corner of History Data Display object on iPad to select the date and display the data.

Data Format Tab

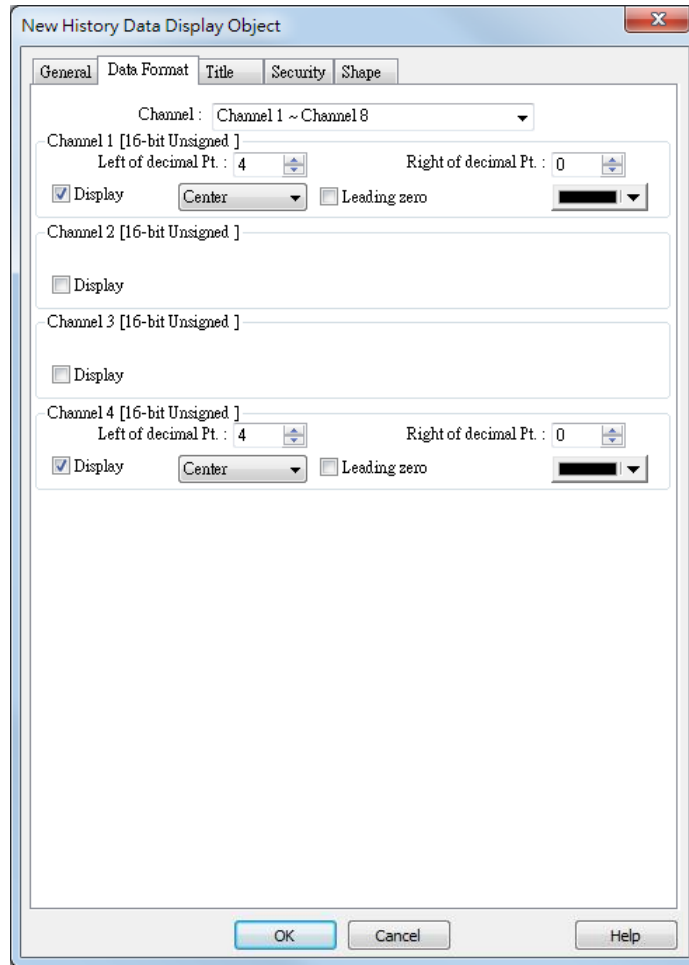

Setting Channel

Description

Each History Data Display object can display up to 64 channels. Check [Display] to select the channels to be shown on the screen. In the figure above, there are 4 channels (channel 1 to channel 4) in the Data Sampling object, and only Ch.1 and Ch.4 are selected. The data formats are shown next to channel name. The data format of each channel is decided by the corresponding Data Sampling objects. The result is shown below:

No.	Time	Date	ch.1	ch
12	09:50:16	10/03/17	0	0
11	09:50:15	10/03/17	0	0
10	09:50:14	10/03/17	0	0
9	09:50:13	10/03/17	0	0
8	09:50:12	10/03/17	0	0
7	09:50:11	10/03/17	0	0
6	09:50:10	10/03/17	0	0
5	09:50:09	10/03/17	0	0

When display [String] format in History Data Display object, there

are two additional options:



- Display in [UNICODE] mode
- Reverse high byte and low byte data and then display.

Title Tab

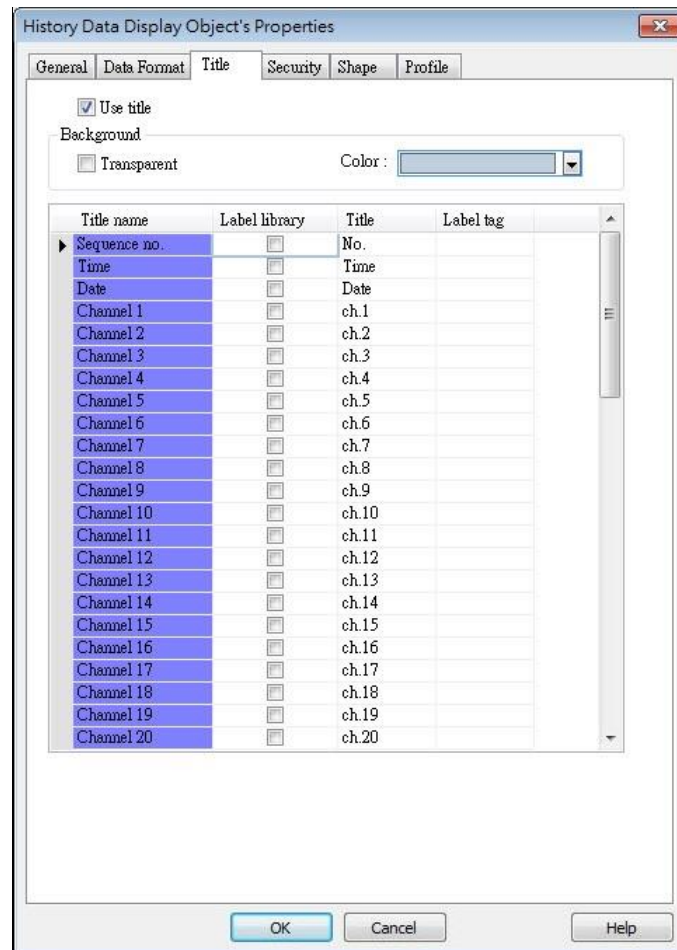

Setting

Description

Use title

Enable or disable title, which is marked as shown below:

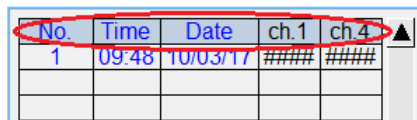

Background

Transparent

When selected, hide the background for title area.

Color

Set the background color of title.

Setting

Defines the text to be shown on the title.

The text can be edited in Label Tag Library. Build the Label Tag Library first, and in History Data Display settings dialog select the

checkbox in the Label Library column, and then select the label tag.

Title name	Label ...	Label tag	Title
Sequence no.	<input checked="" type="checkbox"/>	Label_1	No.
Time	<input type="checkbox"/>		Time
Date	<input type="checkbox"/>		Date
Channel 1	<input type="checkbox"/>		ch.1
Channel 2	<input type="checkbox"/>		ch.2
Channel 3	<input type="checkbox"/>		ch.3

Note

- After running simulation on PC, to run simulation again using the same project that contains some changed data, please find the HMI_memory, SD_card, or usb1 folder in EasyBuilder Pro installation, and then delete the old data sampling records in it, to prevent the system from reading old data in the second simulation.

13.19. Data Block Display

13.19.1. Overview

Data Block is a combination of several word devices with continuous address, where the X axis of Data Block Display object represents the address and the numbers on the Y axis represent the data values in the corresponding address. Data Block Display object can display multiple data blocks. For example, it can display two data blocks LW-12~LW-15 and RW-12~RW-15 in trend curves simultaneously. It is very useful to observe and compare the difference of trend curves.

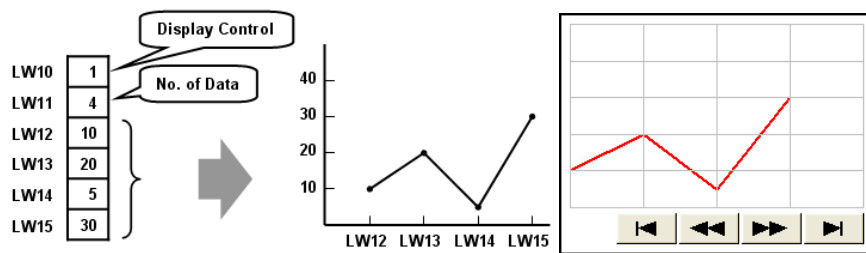

13.19.2. Configuration



Click the Data Block Display icon on the toolbar to open the property dialog box. Set up the properties, press OK button, and a new Data Block Display object will be created.

General Tab

Setting	Description
Comment	Description of the object.
No. of channel	Set the no of channel for this object. Each channel represents one data block. The maximal number of channels is 12.
Cursor Line	If enabled, when user touches the [Data Block Display] object, it will display a vertical cursor line on it, and store the data on the line to the designated registers. See Example 1.
Channel	Select the channel to be configured.
Control address	Specify the control address also the data source. Control address is used to control and clear the drawn curve. After executing the operation below, the system will reset the control word to zero. Enter "0" = No action (default) Enter "1" = Draw (Without clear first) Enter "2" = Clear Enter "3" = Redraw
No. of data address	If control address is LW-n, then LW-n+1 stores the number of word

devices in each data block, i.e. the number of data. The maximum value is 1024.

Data storage start address

If [Offset to start address] is enabled, the [Offset value storage address] will be set as [Control address] + 2.

If select 16-bit data format, the address for each data will be start address, start address + 1, start address + 2 and so on.

If select 32-bit data format, the address for each data will be start address, start address + 2, start address + 4 and so on.

For more information about control address, see Example 2 to 5.

Limit	Set the minimum and maximum limit for the curve.
--------------	--

 **Note**

- The system can draw at most N curves, where N = 32 divided by the number of channel.

Example 1

How to use watch (Cursor Line) feature

Use “Watch” function to check the value of any point of the curve. When the user touches [Data Block] object, it will display a “cursor line”, and the system will write the index and value of that data on the cursor line to the designated address.

Data Format	Index Value	Channel 1 Value	Channel 2 Value
16-bit	Address	Address + 1	Address + 2
32-bit	Address	Address + 2	Address + 4

When watch address is set to LW-n, the value written into LW-n represents the channel index number to be called up. (Start form 0)

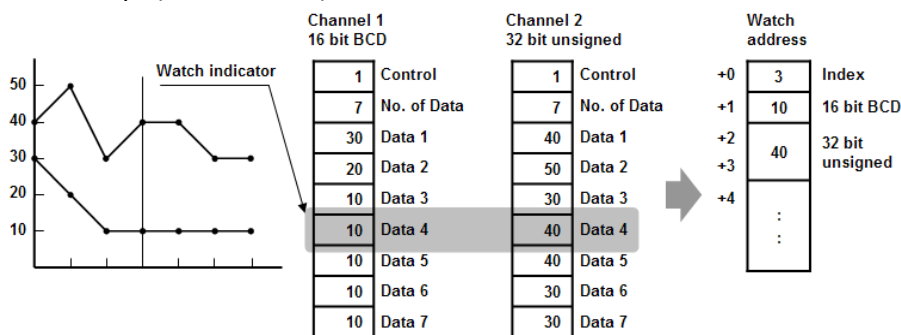

 **Note**

- [Data Index] is a 16 bit unsigned integer. When the designated register of cursor line is 32 bit device, it will be stored in the bit 0-15.
- If the channel to be viewed has no data, “0” will be displayed, as shown below. In the example, there is no data in channel 1, when the cursor points at Data 4, “0” will be displayed as shown below.

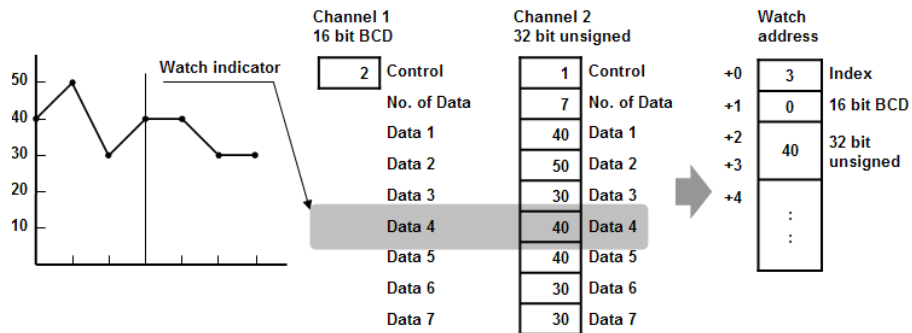

- If there is less data in Channel 1, "0" will be displayed, as shown below.

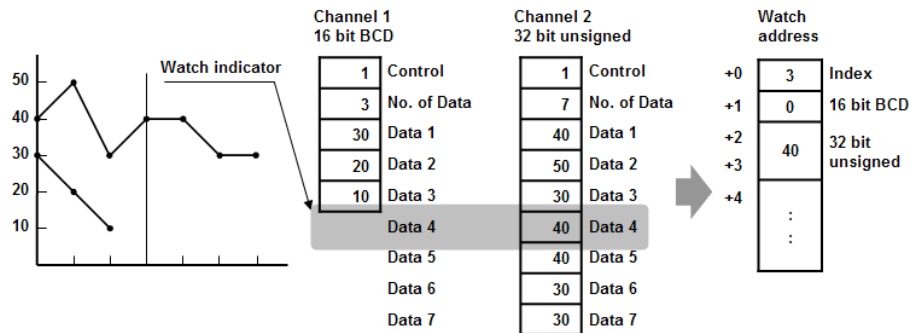

Example 2

How to show a data block

1. Write the number of data to [No. of data address], i.e. "Control address+1"
2. Store the data consecutively beginning at [Data storage start address].
3. Write "1" to [Control address] to draw the curve without cleaning the plot. All previous curves will not be erased.
4. The system will write "0" to [Control address] after marking the plot.

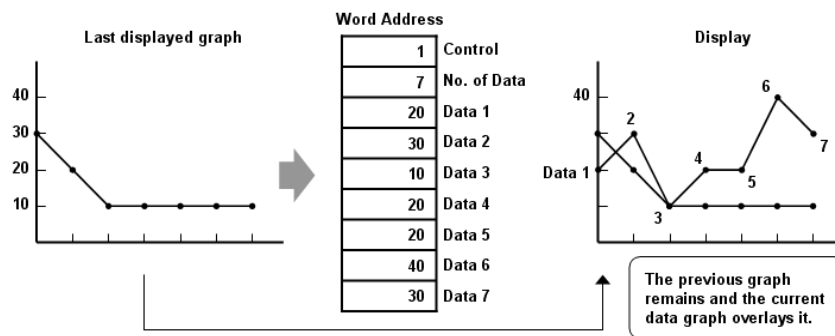

Note

- Do not change the content of [Control address], [No. of data address] and [Data storage start address] between step 3 and step 4 above as doing so might cause error for the trend curve plot.

Example 3

How to clear the graph

1. Write "2" to [Control address], all the trend curves will be cleared.
2. The system will write "0" to [Control address] after the trend curve is cleared.

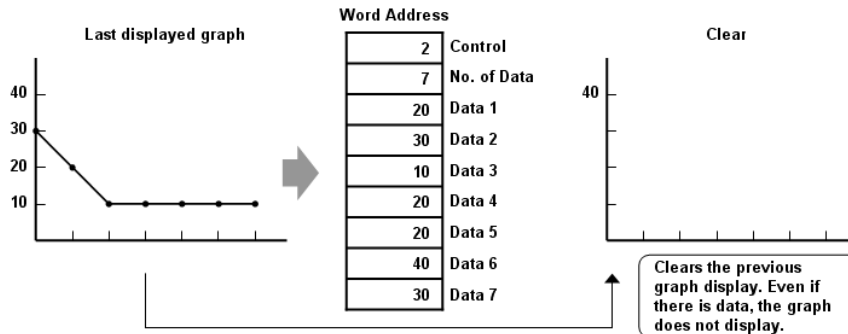

Example 4

How to clear the previous trend curve and display new one

1. Write the number of data to [No. of data address], i.e. "control address+1"
2. Store the data consecutively beginning at [Data storage start address].
3. Write "3" to [Control address], the previous trend curves will be cleared and the new content in data block will be plotted on the screen.
4. The system will write "0" to [Control address] after the trend curve has been plotted.

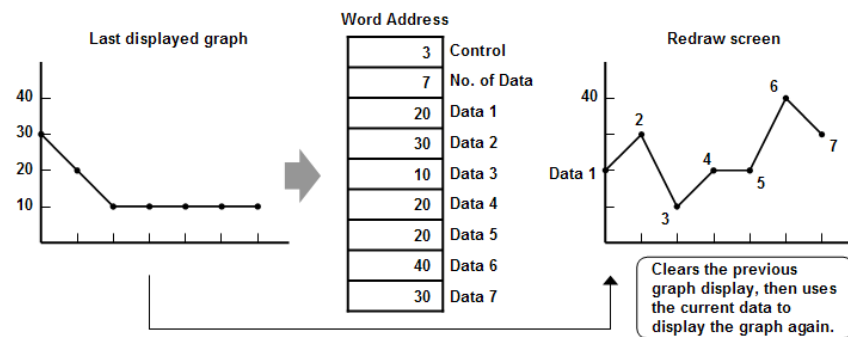

Example 5

How to use offset mode

If [Offset to start address] is selected, [Control address], [No. of data address], and [Offset value storage address] will use 3 consecutive addresses.

For example, assume the total number of channels is 3 (start from 0 to 2), and the [Control address] are LW-0, LW-100, and LW-200, respectively. Then, the other addresses will be set as follows: (In the example, format 16-bit Unsigned is used and [Offset value storage address] are all m).

Item	Channel 0	Channel 1	Channel 2
Control Address	LW-0	LW-100	LW-200
No. of data address	LW-1	LW-101	LW-201
Offset value storage address	LW-2 (=m)	LW-102 (=m)	LW-202 (=m)
Data 1	LW-0+m	LW-100+m	LW-200+m
Data 2	LW-1+m	LW-101+m	LW-201+m
...

The following figure on the left shows the result when offset mode is not used while the figure on the right shows the result when offset mode is used.

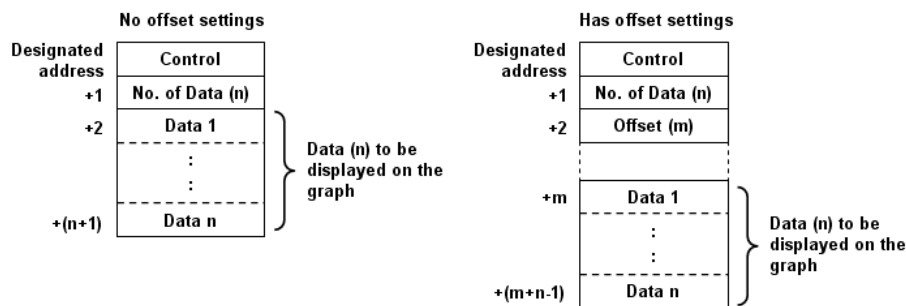

Note

- When [Control address] is set to LW-n, [No. of data address] and [Offset value storage address] are as follows:

Data Type	16-bit	32-bit
Control address	LW-n	LW-n
No. of data address	LW-n+1	LW-n+2
Offset value storage address	LW-n+2	LW-n+4

- If the control registers are 32-bit devices, only bit 0-15 will be used for control purpose, bit 16-31 will be ignored. (as illustrated below)

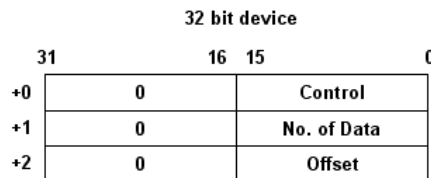

- When the value in [Control address] is not zero, the system will read [No. on data address] and [Offset value storage address].
- It is recommended to use [Offset to start address] for data block display with multiple channels and the same device type. As shown in the following figure, The control words of

channel 1 is located from LW-n, the control words of channel 2 is located from LW-n+3, and so on.

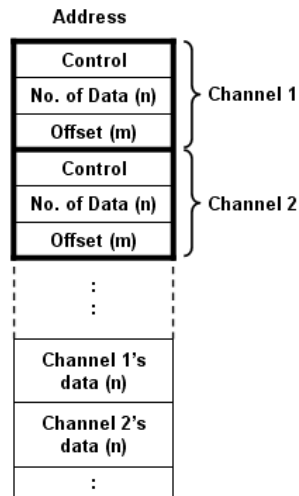

Display Area

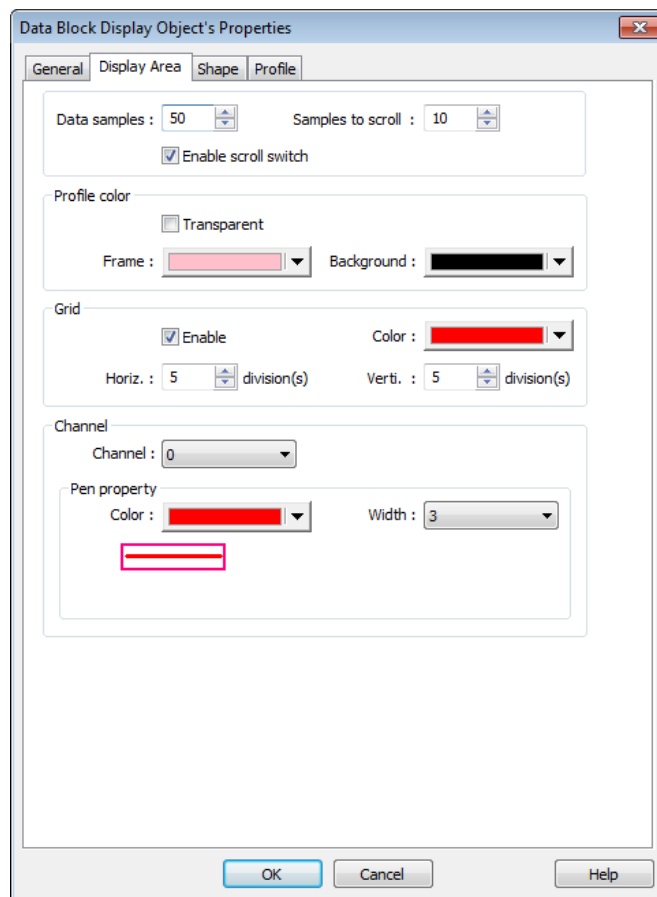



Setting	Description
Description	Data samples Configure the maximal number of data samples (points) to be displayed.

Samples to scroll

Configure the number of data samples being scrolled.

Enable scroll switch

Clicking  displays the previous or next data point.

Clicking  displays the first or the last data point.

Profile

Set the color of the frame and background of the object.

Transparent

Hides the background. Color selection will not be available.

Grid

Set the number of horizontal and vertical divisions shown by grid.

Channel

Set the color, width and style of each curve.

13.20. XY Plot

13.20.1. Overview

XY Plot object is used to display values for two variables (x,y) for a set of data, where the data comes from word registers. Up to 32 channels can be displayed simultaneously. This object facilitates data observation and analysis. Additionally, negative numbers can be displayed as well.

13.20.2. Configuration

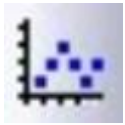

Click the XY Plot icon on the toolbar to open a [XY Plot] object property dialog box.

General Tab

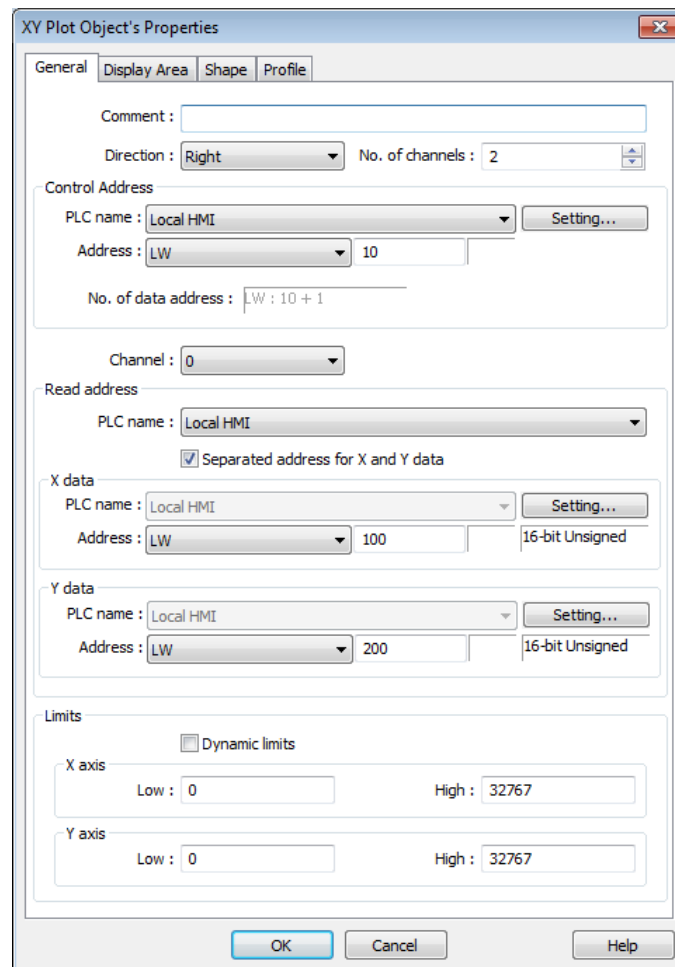

The screenshot shows the 'XY Plot Object's Properties' dialog box with the 'General' tab selected. The dialog has four sub-tabs: 'General', 'Display Area', 'Shape', and 'Profile'. The 'General' tab contains the following fields and controls:

- Comment:** A text input field.
- Direction:** A dropdown menu set to 'Right'.
- No. of channels:** A spinner control set to '2'.
- Control Address:**
 - PLC name:** A dropdown menu set to 'Local HMI' with a 'Setting...' button.
 - Address:** A dropdown menu set to 'LW' and a text input field set to '10'.
 - No. of data address:** A text input field containing the formula 'LW : 10 + 1'.
- Channel:** A dropdown menu set to '0'.
- Read address:**
 - PLC name:** A dropdown menu set to 'Local HMI'.
 - Separated address for X and Y data
 - X data:**
 - PLC name:** A dropdown menu set to 'Local HMI' with a 'Setting...' button.
 - Address:** A dropdown menu set to 'LW' and a text input field set to '100'. The data type is '16-bit Unsigned'.
 - Y data:**
 - PLC name:** A dropdown menu set to 'Local HMI' with a 'Setting...' button.
 - Address:** A dropdown menu set to 'LW' and a text input field set to '200'. The data type is '16-bit Unsigned'.
- Limits:**
 - Dynamic limits
 - X axis:** Low: 0, High: 32767
 - Y axis:** Low: 0, High: 32767

At the bottom of the dialog are three buttons: 'OK', 'Cancel', and 'Help'.

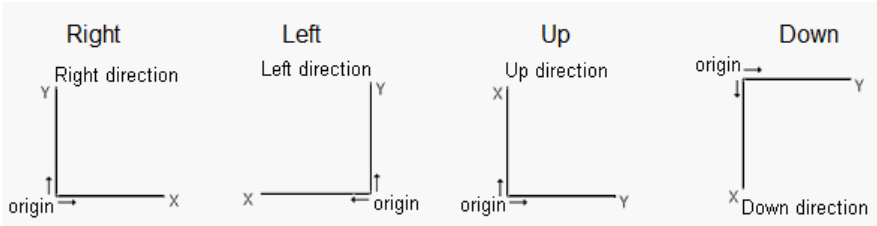
Setting	Description													
Direction	<p>There are four selections, right, left, up or down.</p> 													
No. of channels	Set the number of channels for observation.													
Control address	<p>Controls the operation of all channels simultaneously. When the [Control address] is LW-n, assigning values to LW-n will issue commands to XY plot according to the table below. Meanwhile, LW-n+1 controls the number of data points plotted. After operation, the [Control address] will be reset to 0.</p> <table border="1" data-bbox="488 871 1388 1176"> <thead> <tr> <th>Control address</th> <th>Value</th> <th>Result</th> </tr> </thead> <tbody> <tr> <td rowspan="3">LW-n</td> <td>1</td> <td>Plots point on XY curve. (The plotted points are kept.)</td> </tr> <tr> <td>2</td> <td>Clears all XY curves.</td> </tr> <tr> <td>3</td> <td>Clears then plots new XY curve.</td> </tr> <tr> <td>LW-n+1</td> <td>Any number</td> <td>Controls the number of data points plotted.</td> </tr> </tbody> </table> <p>No. of data address</p> <p>Controls the number of data points. Each channel can plot up to 1023 points.</p>	Control address	Value	Result	LW-n	1	Plots point on XY curve. (The plotted points are kept.)	2	Clears all XY curves.	3	Clears then plots new XY curve.	LW-n+1	Any number	Controls the number of data points plotted.
Control address	Value	Result												
LW-n	1	Plots point on XY curve. (The plotted points are kept.)												
	2	Clears all XY curves.												
	3	Clears then plots new XY curve.												
LW-n+1	Any number	Controls the number of data points plotted.												
Channel	Select a channel to configure.													
Read Address	<p>PLC name</p> <p>Select a PLC which will be the source of [X data] and [Y data] and designate a read address.</p> <p>The format of the data register blocks used for the display channels depends on whether [Separated address for X and Y data] and/or [Dynamic limits] has been selected. See Example 1.</p>													
Dynamic limits	<ul style="list-style-type: none"> When not selected (See Example 2) <p>The Low and High limits can be set by entering constants. The Low and High limits are used for calculating X and Y range in percentage.</p> <ul style="list-style-type: none"> When selected (See Example 3) <p>A zoom effect can be created by changing the Low / High Limits.</p>													

Example 1

The format of the data register blocks used for the display channels depends on whether [Separated address for X and Y data] has been selected, and if [Dynamic limits] has been selected. The following explains the situations where 16-bit register is used:

- If [Separated address for X and Y data] is **not** selected, and set [Read address] to LW-n:

	Select [Dynamic limits]		Not select [Dynamic limits]	
	X data	Y data	X data	Y data
Low Limit	LW-n	LW-n+2	Constant	Constant
High Limit	LW-n+1	LW-n+3	Constant	Constant
1 st data	LW-n+4	LW-n+5	LW-n+0	LW-n+1
2 nd data	LW-n+6	LW-n+7	LW-n+2	LW-n+3
3 rd data	LW-n+8	LW-n+9	LW-n+4	LW-n+5
4 th data	LW-n+10	LW-n+11	LW-n+6	LW-n+7

- If [Separated address for X and Y data] is selected, and set [X data] to LW-m, [Y data] to LW-n:

	Select [Dynamic limits]		Not select [Dynamic limits]	
	X data	Y data	X data	Y data
Low Limit	LW-m+0	LW-n+0	Constant	Constant
High Limit	LW-m+1	LW-n+1	Constant	Constant
1 st data	LW-m+2	LW-n+2	LW-m+0	LW-n+0
2 nd data	LW-m+3	LW-n+3	LW-m+1	LW-n+1
3 rd data	LW-m+4	LW-n+4	LW-m+2	LW-n+2
4 th data	LW-m+5	LW-n+5	LW-m+3	LW-n+3

Example 2

When [Dynamic limits] is not selected, the Low and High limits can be set. The Low and High limits are used for calculating X and Y range in percentage.

$$\text{Scale (\%)} = \frac{\text{Read Address Value} - \text{Low Limit}}{\text{High Limit} - \text{Low Limit}}$$

If [Separated address for X and Y data] is **not** selected and the address is LW-n, the corresponding limits are retrieved from the addresses as shown in the following table.

Data format	16-bit	32-bit
X axis low limit	LW-n	LW-n
X axis high limit	LW-n+1	LW-n+2
Y axis low limit	LW-n+2	LW-n+4
Y axis high limit	LW-n+3	LW-n+6

Example 3

If **[Dynamic limits]** is selected, a zoom effect can be created by changing the setting of Low / High Limits.

In the following example, XL=X low limit, XH=X high limit, YL=Y low limit, YH=Y high limit, and XY, XY1, XY2 are three XY data. When changing the high limits of X and Y axis, the result is shown below:

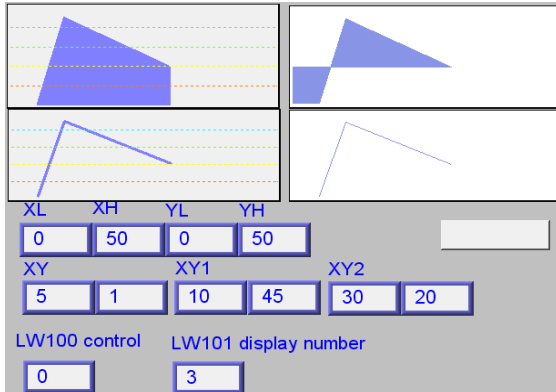

Original

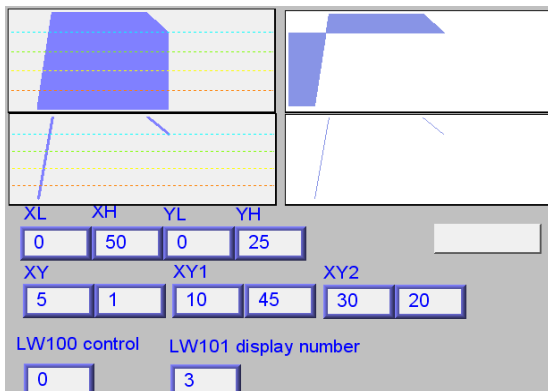

Change the high limit of Y axis to 25.
(zoom in)

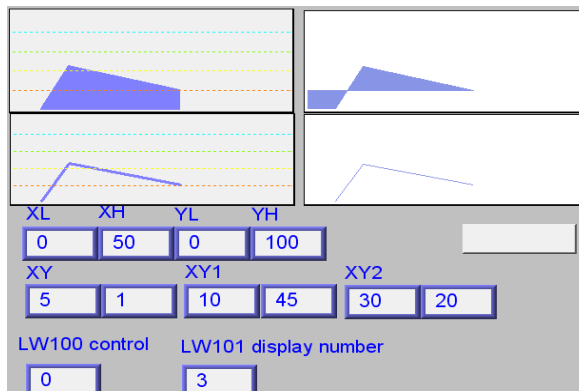

Change the high limit of Y axis to 100 (zoom out)

For more information, see “13.17 Trend Display”.

Note

- For cMT Series, on the screen of the visualization device directly pinch two fingers together to zoom out or spread them apart to zoom in.
- X and Y data can be set to different formats. For example: If X data uses 16-bit unsigned, Y data uses 32-bit signed, please note the address setting.
- When using a Tag PLC, such as AB tag PLC, X and Y must be in the same format. When using different formats a warning will be shown.

Display Area Tab

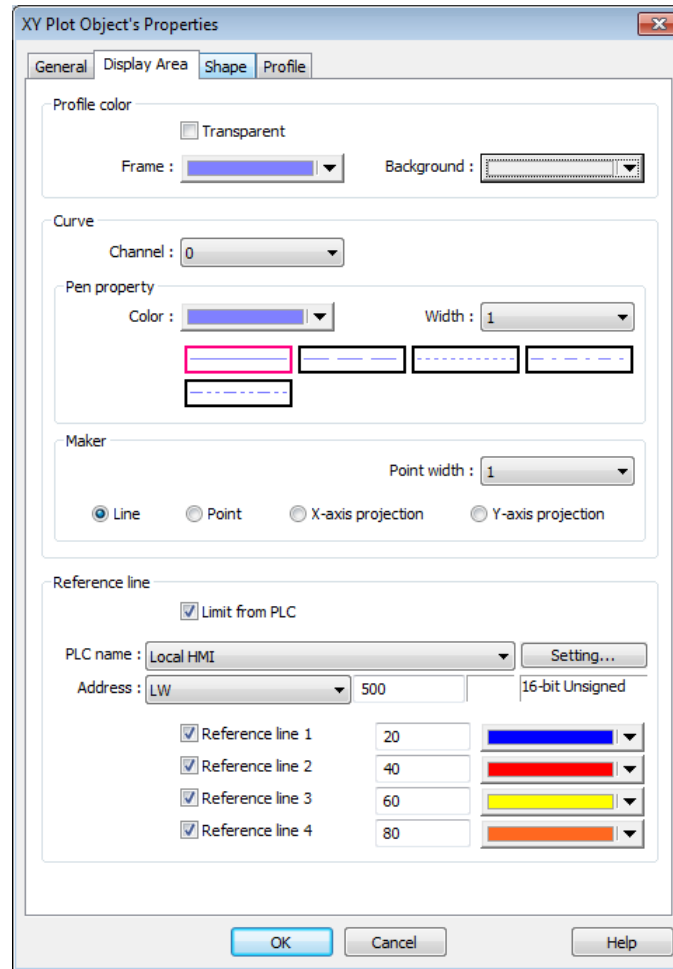

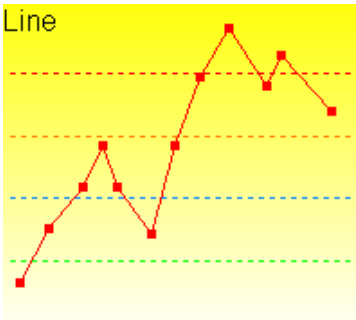
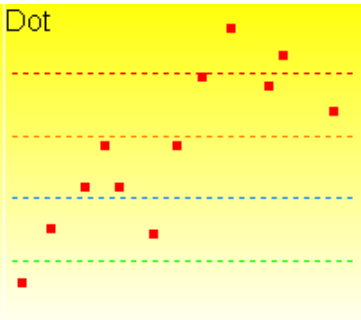
Setting	Description
Profile color	Select the color of the frame and the background, or select [Transparent] check box to hide the frame and background.
Curve	For each channel select the properties of color, width, and line style.
Maker	There are four different types of XY plot. The result is shown below:
	<div style="display: flex; justify-content: space-around;"> <div style="text-align: center;"> <p>Line</p>  </div> <div style="text-align: center;"> <p>Dot</p>  </div> </div>

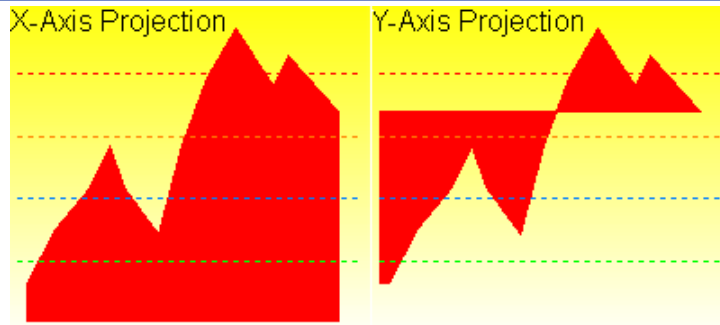

See Example 4.

Reference line Up to 4 horizontal reference lines can be shown on the graph. Fill in high, low limits and Y axis percentage values. Different colors can be selected for each reference line.
 If [Limit from PLC] is selected, designate a register to be the read address of reference line.

Example 4

The curve shown in the following figure is drawn with 7 points numbered from P0 to P6. The steps the system draws the X-axis Projection are:

1. Calculates the two points in X-axis – $(X_0, 0)$ and $(X_6, 0)$.
2. Link all the points in the order of $(X_0, 0)$, P0... P6, $(X_6, 0)$ and returns to $(X_0, 0)$ at last.
3. Fill out all enclosed areas.

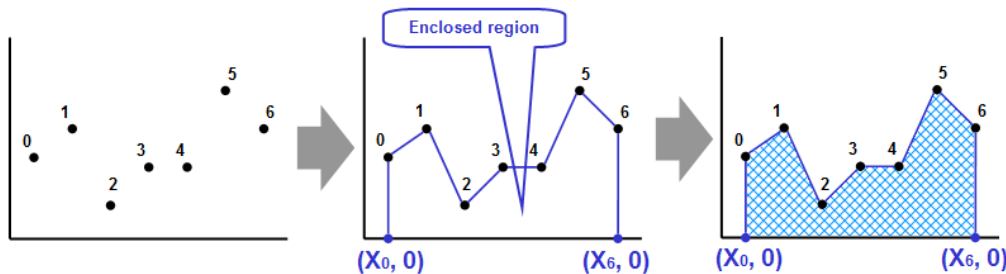

Similarly for Y-axis projection:

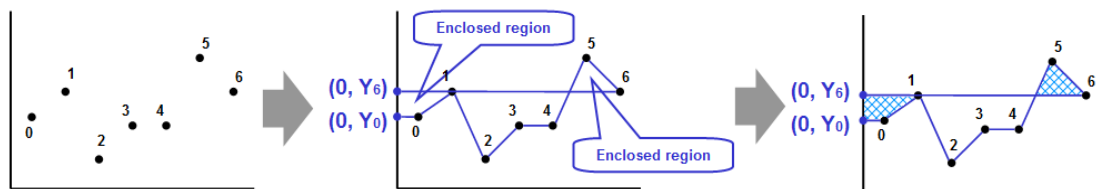

Note

- XY Plot can be drawn repeatedly up to 32 times:
 - 1 channel → 32 times
 - 2 channels → 16 times
 The way to calculate: 32 divided by the number of channels.

13.21. Alarm Bar and Alarm Display

13.21.1. Overview

Alarm Bar and Alarm Display objects are used to display alarm messages which are defined in Event (Alarm) Log objects. When the trigger conditions are met, events or alarms will be displayed as they occur in chronological order in Alarm Bar or Alarm Display object. Alarm Bar scrolls all alarm messages in one single display line, whereas Alarm Display shows alarm messages in multiple lines.

 For more information, see “7 Event Log”.

! (When LW 1 >= 10) 13:21:06 Event 0 (when LW0

Alarm Bar - Displays alarm messages in one scrolling line.

***13/12/06 13:21:38 Event 2 (when LB10 = ON)
13/12/06 13:21:38 Event 3 (when LB11 = ON)
13/12/06 13:21:38 Event 0 (when LW0 == 100)
13/12/06 13:21:38 Event 1 (When LW 1 >= 10)***

Alarm Display – Displays alarm messages in multiple lines.

13.21.2. Configuration

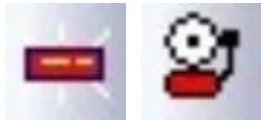

Click the Alarm Display or Alarm Bar icon on the toolbar to open the object property dialog box. Set up the properties, press OK button, and a new object will be created.

General Tab

The difference between these two objects is that Alarm Display allows an [Acknowledge address] and a [Scrolling control address] to be set.

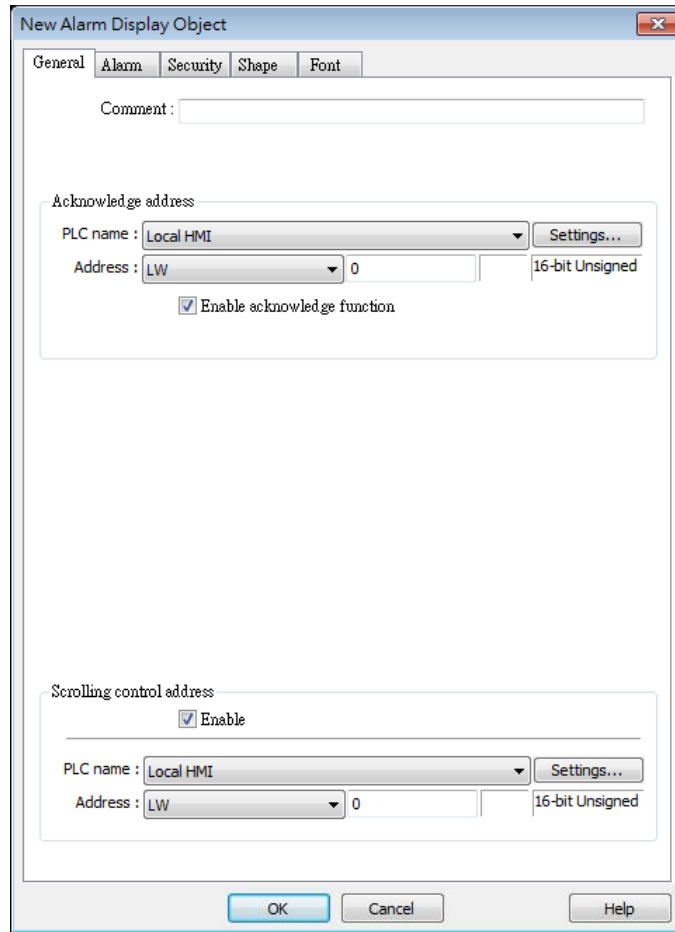

Setting	Description
<p>Enable acknowledge function</p>	<p>If selected, the [Acknowledge value] selected for the associated event, specified in Alarm (Event) Log » Message tab will be written to the [Acknowledge address] designated in Alarm Display. For more information, see “7 Event Log”.</p> <div style="border: 1px solid #ccc; padding: 5px; margin-top: 10px;"> <p>Acknowledge value for Event/Alarm Display object</p> <p>Acknowledge value : <input style="width: 100px;" type="text" value="11"/></p> </div>
<p>Scrolling control address</p>	<p>If enabled, the value in the designated control address indicates the number of lines to be scrolled down. The minimal value is 0, which indicates the first line.</p>

Note

- When using cMT-SVR, press and hold the event on the screen to acknowledge an event; drag a finger on the screen to scroll.

Alarm Tab

Alarm Bar

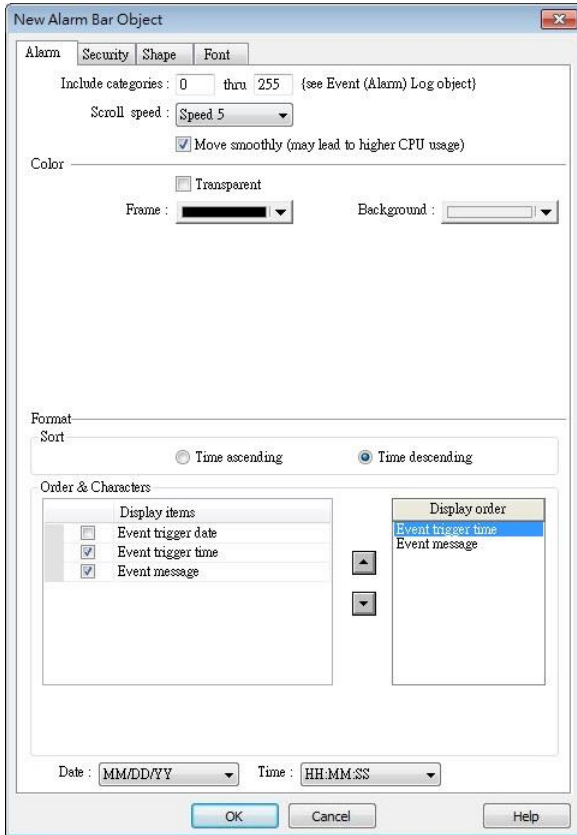

Alarm Display

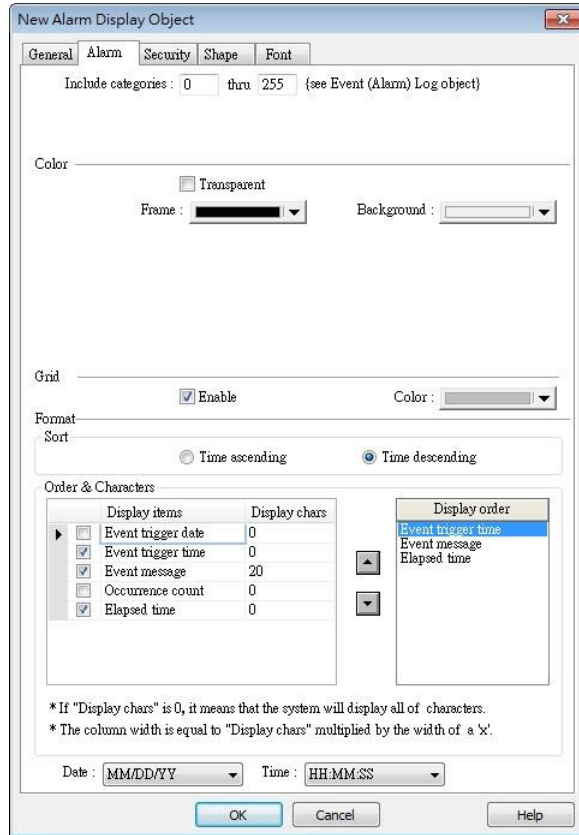

Alarm Display object has extra settings compared to Alarm Bar object: [Occurrence count] and [Elapsed time]. The table below introduces the settings shared between these two objects.

Setting	Description
Include categories	Events in the selected category will be displayed. The categories are set in Event (Alarm) Log object. For example, if the category is set to “2 to 4” here, only events in categories 2, 3, 4 will be displayed. For more information, see “7 Event Log”.
Scroll speed	This selection is only available for Alarm Bar. Select one of the speed settings at which the messages scroll.
Move smoothly	When this option is selected, the message will move along the alarm bar more smoothly. Please note that enabling this may lead to high CPU loading.
Format	Time ascending Latest alarm is placed last in the list (the bottom).
	Time descending Latest alarm is placed first in the list (the top).

Display order

Select the items to be displayed and use the up and down arrow buttons to adjust the display order of the alarms.

Date

Displays the date tag with each alarm message. The four formats of date tag:

MM/DD/YY 、 DD/MM/YY 、 DD/MM/YY 、 YY/MM/DD

Time

Displays the time tag with each alarm message. The four formats of time tag:

HH:MM:SS 、 HH:MM 、 DD:HH:MM 、 HH

Security Tab

Alarm Bar

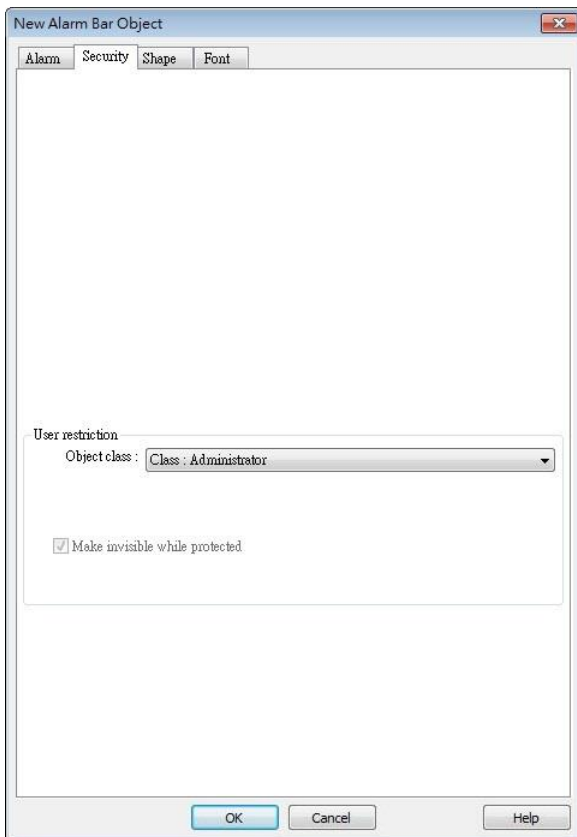

Alarm Display

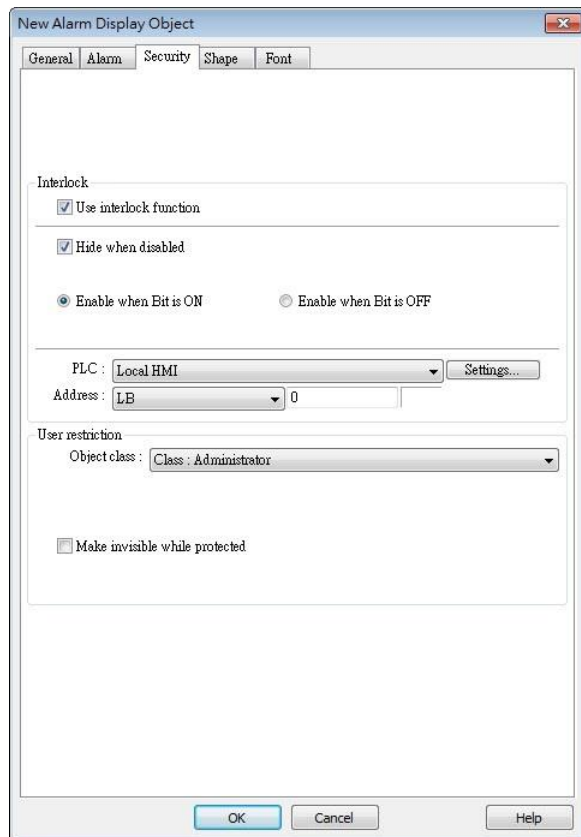

Setting

Description

Interlock

When [Use interlock function] check box is selected, whether the object is operable is determined by the state of a designated Bit address. As shown in the above settings, if LB-0 is ON, the object is operable.

Hide when disabled

When the designated Bit is OFF, the object will be hidden.

User restriction

Set the security class of the object to be operated by an authorized user.

Object class

“None” means any user can operate this object. Only account “admin” can operate “Administrator” object class.

Make invisible while protected

When the user's privilege does not match the object class, the object will be hidden.

When this check box is deselected in Alarm Display object settings, the unauthorized user can see the Alarm Display object, but cannot trigger the object or make any change.

This check box is greyed out in Alarm Bar object settings.

Font Tab

Set the font size or select [Italic].

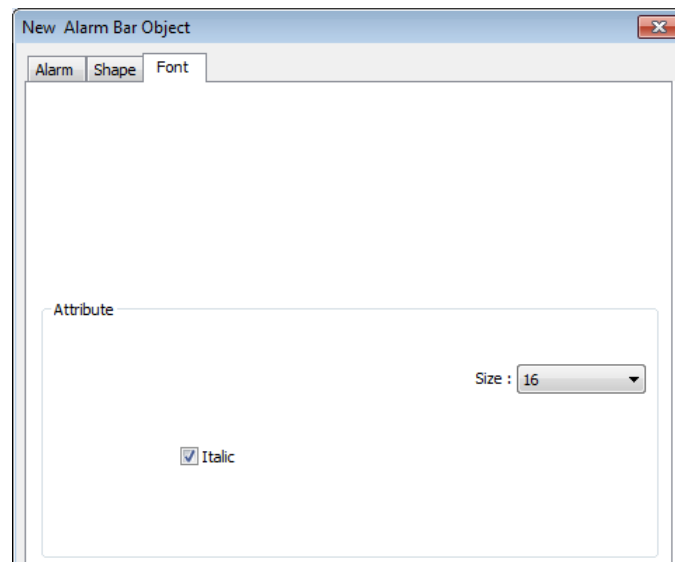

The font, color, and content of the alarm messages displayed in Alarm Bar and Alarm Display objects are set in Alarm (Event) Log object:

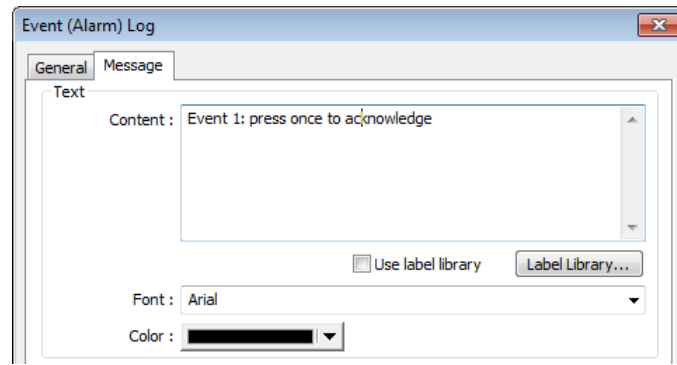

13.22. Event Display

13.22.1. Overview

Event Display object is used to display event messages which are defined in Event (Alarm) Log and have met a trigger condition. The triggered events are displayed in the chronological order. Event Display object displays: the date and time the event occurs, the time the event is acknowledged, the time the event returns to normal, the event message, the occurrence count, and the elapsed time. Multi-lined messages can also be displayed.

8	12/13/06	22:03:15		Event 3 (when LB11 = ON)
7	12/13/06	22:03:14	22:03:17	Event 2 (when LB10 = ON)
6	12/13/06	22:03:13		Event 1 (When LW 1 >= 10)
5	12/13/06	22:03:12		Event 0 (when LW0 == 100)
4	12/13/06	22:02:57		Event 3 (when LB11 = ON)
3	12/13/06	22:02:56	22:03:04	Event 2 (when LB10 = ON)
2	12/13/06	22:02:56	22:02:58	Event 1 (When LW 1 >= 10)

1	07/27/10	14:32:56	14:32:57	14:32:59	Event 0 LW 0 < 2 Multi-text
---	----------	----------	----------	----------	-----------------------------------

Multi-text

13.22.2. Configuration



Click the Event Display icon on the toolbar to open an Event Display object property dialog box. Set up the properties, press OK button, and a new Event Display object will be created.

General Tab

13.22.2.1. eMT, iE, XE, mTV Series

Setting	Description
Mode	<p>The available modes are: [Real-time] and [History].</p> <ul style="list-style-type: none"> ● Real-time All the events triggered since HMI starts up are displayed. ● History The system reads the event log in HMI memory and displays them. The content can be updated by changing window. In case when the trend display shows history data from today, the display will refresh once per second.
Acknowledge address	<p>When in Real-time mode, and an event is acknowledged by touching an active display line, the [Acknowledge value] specified in Event (Alarm) Log object, Message tab, is output to the [Acknowledge address] of Event Display object. For more information, see “7 Event Log”.</p>

Acknowledge value for Event/Alarm Display object

Acknowledge value : 11

History Control

When in History mode, and if:

- [Enable reading multiple histories] is **not** selected

Daily event log files can be displayed. A history control address can be designated. The value in the designated register is used as an index to select historical files.

Index value 0 displays the latest file.

Index value 1 displays the second latest file.

Index value 2 displays the third latest file, and so on.

If control address to LW-100, and four data log exist with dates: EL_20100720.evt, EL_20100723.evt, EL_20100727.evt, and EL_20100803.evt.

Each index value in the control word corresponds to a record according to the table below:

Value in LW-100	The corresponding record
0	EL_20100803.evt
1	EL_20100727.evt
2	EL_20100723.evt
3	EL_20100720.evt





- [Enable reading multiple histories] is selected

Displays a list of events triggered in multiple days. If [History control] address is set to LW-n, the LW-n to LW-n+1 form a range of log selection. Please note that the control address leads to different results in “Number of days” mode and in “Index of the last history” mode.

Number of days

Display range is determined by the value in control address. [LW-n] marks the number of days from today as the start date of display, and [LW-n+1] marks the number of days preceding the start date, inclusive of the start date, as the end date.





Example: If today were 2010/6/10, and the value in LW-n is 1, LW-n+1 is 3, then the data range will start from 1 day from today (LW-n = 1), which is 20100609 (yesterday) in this case, and include data for the preceding 3 days, inclusive of 20100609. As a result, the data displayed should be 20100607~20100609. Since 20100607 does not exist in this example, the data displayed will be from 20100609 and 20100608.

 EL_20100604	No.4	1 KB	EVT
 EL_20100605	No.3	6 KB	EVT
 EL_20100608	No.2	17 KB	EVT
 EL_20100609	No.1	4 KB	EVT
 EL_20100610	No.0	12 KB	EVT

Index of the last history

The value in control address [LW-n] marks the index value of the

record to start, and the value in [LW-n+1] marks the index value of the record to end. If LW-n = 1, and LW-n+1 = 3, the data displayed will include data No.1, No.2, No.3.

 EL_20100604	No.4	1 KB	EVT
 EL_20100605	No.3	6 KB	EVT
 EL_20100608	No.2	17 KB	EVT
 EL_20100609	No.1	4 KB	EVT
 EL_20100610	No.0	12 KB	EVT

Please note that the value in [LW-n+1] must be greater than the value in [LW-n], to form a valid range.

The maximum size of data that can be displayed is 4MB; the exceeding part will be ignored.

The following shows how data will be stored when the data size is too big.

5 history data, each 0.5MB → Data displayed: 8 x 0.5MB

5 history data, each 1MB → Data displayed: 4 x 1MB

5 history data, each 1.5MB → Data displayed:

2 x 1.5MB+1 x 1MB (partial)

Control address

Enable event management

If this check box is selected, writing a specific value into register LW-n and LW-n+1, where n is an arbitrary number, will control [Event Display] object with different commands as shown below:

Address	Value	Command
LW-n	0	Display all events.
	1	Hide [Confirmed] events.
	2	Hide [Recovered] events.
	3	Hide [Confirmed] or [Recovered] events.
	4	Hide [Confirmed] and [Recovered] events.
LW-n+1	1	Delete a single selected event.

Scrolling control address

If enabled, the value in the designated control address indicates the number of lines to be scrolled down. The minimal value is 0, which indicates the first line.

In the following figure, there are 10 events recorded in the object, and value 3 is set at the control address. The upper event object displays the events in time ascending order, and begins at the 4th event; on the other hand, the lower one displays the events in time descending order, and begins at the 7th event.

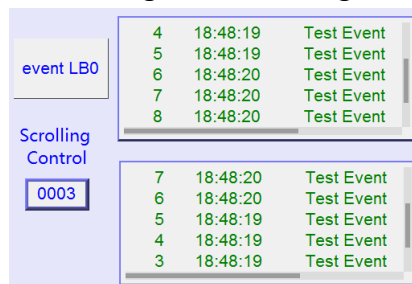

If [Scrolling control address] is enabled, the scroll bar cannot be used for scrolling, but still shows the relative position of the content. If the control address holds a value that is larger than the total number of lines, the display will stroll to the end.

13.22.2.2. cMT-SVR Series

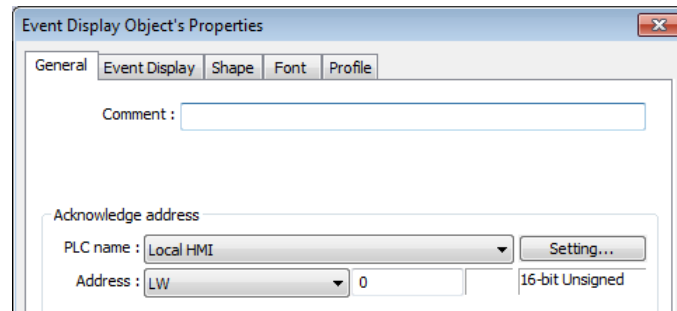

For cMT-SVR, all the events occur are displayed and updated in real-time. Press the filter icon in the upper-right corner of the object and set the start and end date. If the dates are not set, all the events are displayed.

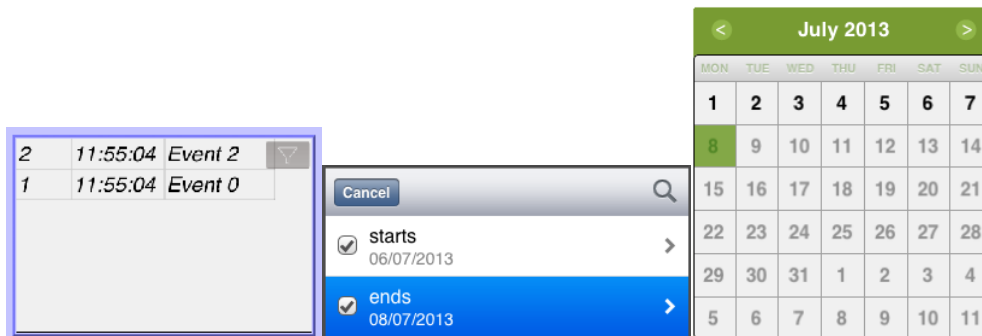

Event Display Tab

cMT Series

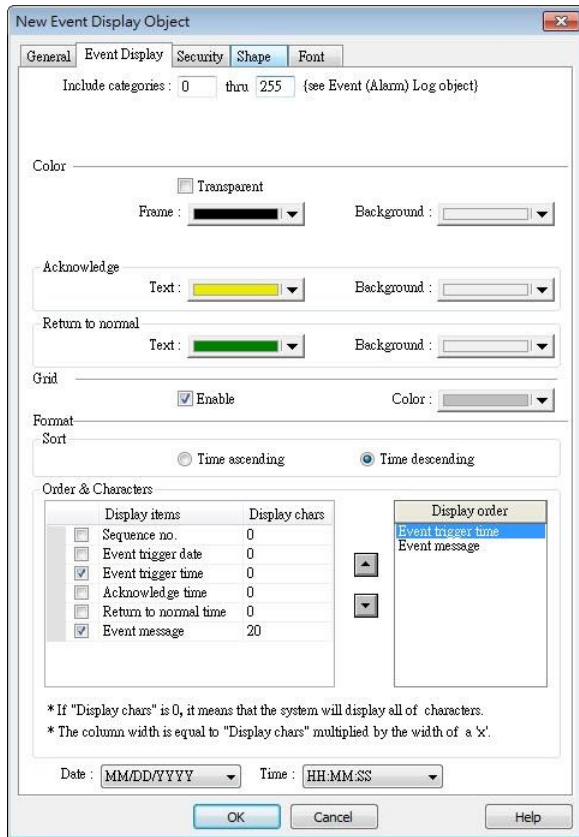

eMT, iE, XE, mTV Series

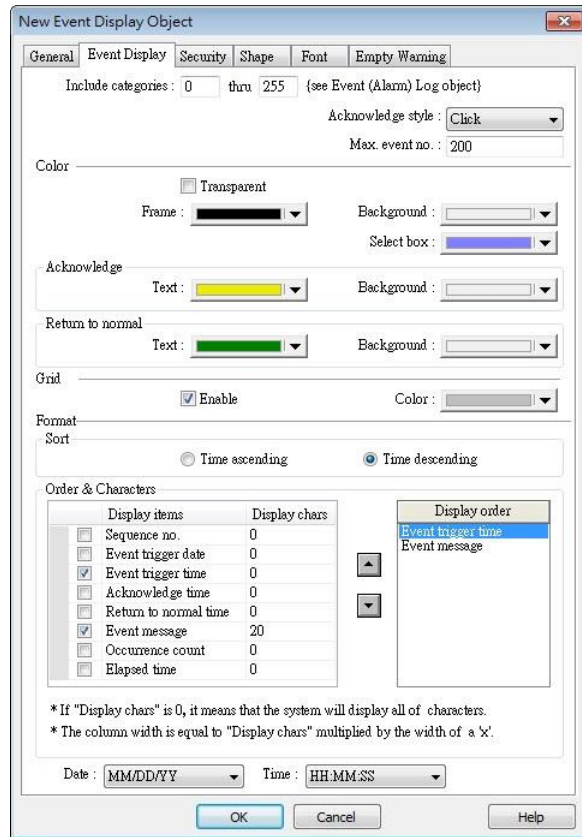

Setting	Description
Include categories	Events in the selected category will be displayed. The categories are set in Event (Alarm) Log object. For example, if the category is set to 2 to 4 here, only events in categories 2, 3, 4 will be displayed. For more information, see “7 Event Log”.
Acknowledge style	Select [Click] or [Double Click] to acknowledge each single event. When an event occurs the user can tap the event line once or twice to acknowledge the new event. When acknowledged, the text color of the event will change to the selected color, and the acknowledge value associated with that event will be sent to the register designated in [Acknowledge address]. If the address is set to LW-100, and the acknowledge value is set to 31, when user acknowledges the event, value 31 is written to LW-100. This can be used in conjunction with Indirect Window object so that when an event is acknowledged, the corresponding message window is displayed.
Max. event	The maximum number of events to be displayed in this Event

no. Display object. When the number of the displayed events equals to the set maximum number, the new coming event will overwrite the latest event.

Color Different colors indicate different event states, such as acknowledged, returns to normal, or selected. The system draws a highlight box around the latest selected event.

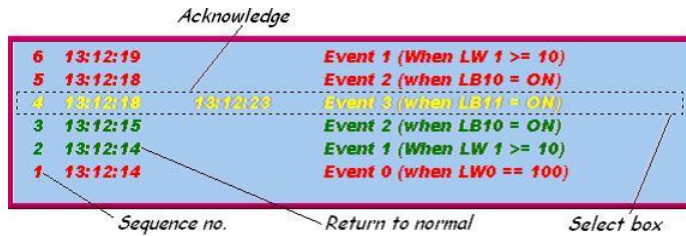

History background (eMT, iE, XE, mTV)

When using Event Display object and select History mode, the background color of the history record can be customized.

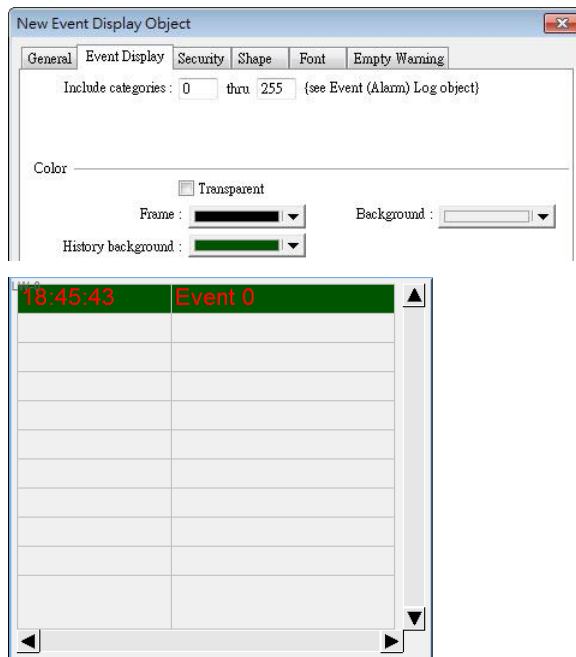

Grid Displays a grid of rows and columns in the object. The color of the grid lines can be selected.

Format

	trigger date	trigger time	notification time	return to normal time	
0	12/14/06	15:26:21	15:26:31	15:26:36	Event 0 (when LV
1	12/14/06	15:26:47	15:26:50		Event 1 (when LB
2	12/14/06	15:26:48			Event 2 (when LE

Time ascending

Latest event is placed last in the list (the bottom).

Time descending

Latest event is placed first in the list (the top).

Order & Characters

Select the items to be displayed and use the up and down arrow buttons to adjust the display order of the events.

Date

Displays the date tag with each event message. The four formats of date tag:

MM/DD/YY 、 DD/MM/YY 、 DD/MM/YY 、 YY/MM/DD

Time

Displays the time tag with each event message. The four formats of time tag:

HH:MM:SS 、 HH:MM 、 DD:HH:MM 、 HH

Security Tab

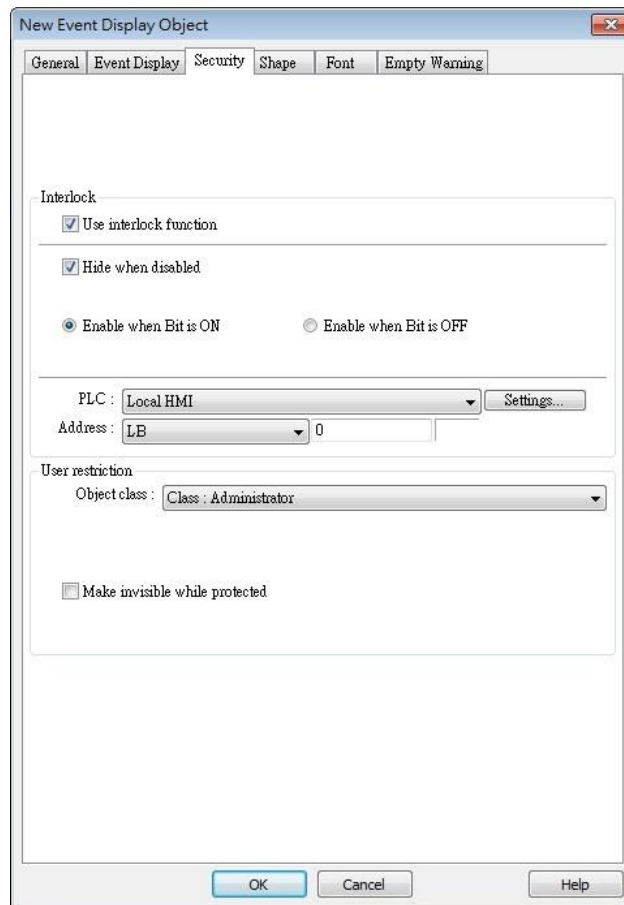

Setting	Description
Interlock	When [Use interlock function] check box is selected, whether the object is operable is determined by the state of a designated Bit address. As shown in the above settings, if LB-0 is ON, the object is operable.
Hide when disabled	When the designated Bit is OFF, the object will be

User restriction

hidden.

Set the security class of the object to be operated by an authorized user.

Object class

“None” means any user can operate this object. Only account “admin” can operate “Administrator” object class.

Make invisible while protected

When the user's privilege does not match the object class, the object will be hidden.

When this check box is deselected, the unauthorized user can see the Event Display object, but cannot trigger the object or make any change.

Font Tab

In Real-time mode: Users may select Italic font and set the font size. The font is displayed according to the setting in Event Log object.

In History mode: Users may select Italic font and set the font size, font and color, or tick the [Font from label library] check box.

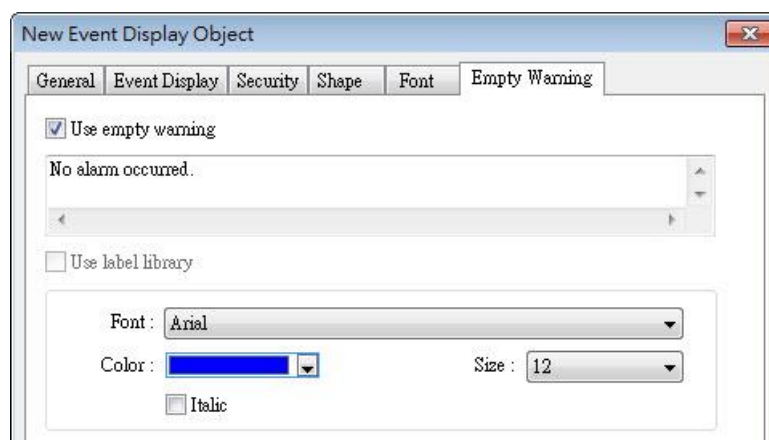
**Empty Warning**

When [Use empty warning] is enabled, the text displayed when no event has occurred can be specified.

13.23. Data Transfer (Trigger-based)

13.23.1. Overview

Data Transfer (Trigger-based) object can transfer values from the source register to the destination register. The data transfer operation can be activated by changing the state of the designated bit register, or by manually pressing the object.

For cMT Series, only touch trigger mode is available.

13.23.2. Configuration

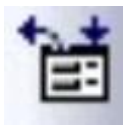

Click the Data Transfer (Trigger-based) icon on the toolbar to open the property dialog box. Set up the properties, press OK button, and a new Data Transfer (Trigger-based) object will be created.

General Tab

cMT Series

eMT, iE, XE, mTV Series

Setting	Description
Source address	Data Transfer object reads the data from [Source Address].
Destination address	Data Transfer object writes the data to [Destination Address].
Attribute	<p>No. of words The number of words to be transferred from [Source Address] to [Destination Address]. The unit is word.</p> <p>Mode</p> <p>Touch trigger Press the object to activate data transfer operation.</p> <p>External trigger The data transfer operation is activated when the state of the designated bit address changes. There is a further selection to make of whether the data transfer operation is activated after Off to ON, ON to OFF transition, or at both of the changes of state.</p>
Trigger address	Specify a bit address for [External trigger] mode.
Notification	<p>When enabled, the system will set the designated address ON or OFF when it's ready for data transfer.</p> <p>Follow The notification bit will reset to its original state once the system starts data transfer.</p>

Note

- When using Data Transfer Trigger Based object, place the control bit addresses in the same window in order to trigger Data Transfer. If the Data Transfer Trigger Based object is placed in the common window, when the state of the control bit addresses placed in any window changes, Data Transfer is triggered.

13.24. Backup

13.24.1. Overview

Backup (Trigger-based) object and Backup (Global) object can transmit recipe data (RW, RW_A), event log, recipe database, sampling data, and operation log to an external device (SD card, USB disk), in a specified time range or format. For example, when the event log is saved in a SD card, a USB disk can be inserted when HMI power is still ON, and use Backup object to copy the data into USB disk from SD card, and then remove USB disk without turning off HMI power. The data saved in USB disk can be used on PC for analyzing. When the system is backing up, the state of system register [LB-9039] is set ON. With [e-Mail] option, information can be sent to configured email contacts.

Backup (Trigger-based) object is triggered by pressing the object on the screen while Backup (Global) object runs in the background regardless of screens being viewed. Backup (Global) object is available only on cMT Series models.

13.24.2. Configuration



On the toolbar click [Objects] » [File Operation] to find [Backup (Trigger-based)] and [Backup (Global)] objects.

Open [Backup (Trigger-based)] object property dialog box, set up the properties, press OK button, and a new Backup (Trigger-based) object will be created.

When using a cMT Series model, [Backup (Global)] object is available. Open [Backup (Global)] object managing dialog box, click [New] to open the object property dialog box, set up the properties, press OK button, and a new Backup (Global) object will be created.

General Tab

Backup (Trigger-based)

cMT Series

New Backup (Trigger-based) Object

General | Security | Shape | Label

Comment : _____

File source

RW RW_A Recipe database

Historical data sampling Historical event log

Operation log

Backup position

USB disk SD card e-Mail

* Use LW-9032-9039 to change the backup folder name.

Storage format

Format : Comma Separated Values (*.csv)

Add BOM (Byte Order Mark) to file header for EXCEL can interpreting non-ASCII strings correctly.

Include title Include export time

Range

Start : Today Yesterday

Within : All

Trigger

Mode : Touch trigger

*LB-9039 indicates the status of file backup activity (backup in process if status is ON)

OK Cancel Help

eMT, iE, XE, mTV Series

New Backup (Trigger-based) Object

General | Advance | Security | Shape | Label

Comment : _____

File source

RW RW_A Recipe database

Historical data sampling Historical event log

Operation log

Backup position

USB disk SD card e-Mail

Remote printer/backup server

* Use LW-9032-9039 to change the backup folder name.

* Use [Remote printer/backup server] to store data to a remote PC. Enable the server in [System Parameter][Printer/Backup Server] settings.

Storage format

Format : Comma Separated Values (*.csv)

Add BOM (Byte Order Mark) to file header for EXCEL can interpreting non-ASCII strings correctly.

Include title Include export time

Include occurrence count Include elapsed time

Range

Start : Today Yesterday

Within : All (max. 90 days)

Trigger

Mode : Touch trigger

*LB-9039 indicates the status of file backup activity (backup in process if status is ON)

OK Cancel Help

Backup (Global) cMT Series

Backup (Global)

General

Comment : _____

File source

RW RW_A Recipe database

Historical data sampling Historical event log

Operation log

Backup position

USB disk SD card e-Mail

* Use LW-9032-9039 to change the backup folder name.

Storage format

Format : Comma Separated Values (*.csv)

Add BOM (Byte Order Mark) to file header for EXCEL can interpreting non-ASCII strings correctly.

Include title Include export time

Range

Start : Today Yesterday

Within : All

Trigger

Mode : External trigger (bit)

Condition : OFF->ON

Trigger address Follow (set OFF when backup finished)

PLC : Local HMI

Address : LB 0

*LB-9039 indicates the status of file backup activity (backup in process if status is ON)

OK Cancel Help

Setting	Description
Source	<p>[RW], [RW_A], [Recipe database], [Historical event log], [Historical data sampling], [Operation log]</p> <p>Select one from the above for the source. When backing up [Historical data log], use [Data Sampling object index] to select the one to back up.</p>
Backup position	<p>Select the destination where the source files will be saved to.</p> <p>SD card / USB disk</p> <p>The external device connected to HMI.</p> <p>If using cMT series, SD card and USB disk can only save [RW], [RW_A], and [Recipe database].</p> <p>Remote printer/backup server (eMT, iE, XE, mTV Series)</p> <p>To select this, enable MT remote printer/backup server at: [Menu] » [Edit] » [System Parameters] » [Printer/Backup Server].</p> <p>Please note that [Operation log] backup can only be saved to Remote printer/backup server. To save into a SD card or USB drive, please use the control address of Operation Log object.</p> <p> For more information, see “26 EasyPrinter”.</p> <p>E-mail</p> <p>To use e-mail, go to [System Parameters] » [e-Mail] tab to configure first. And then go to Backup object » [e-Mail] tab to configure the recipient address, subject, and message.</p>
Save format	<p>Select the desired format to back up the file.</p> <p>eMT, iE, XE, mTV Series:</p> <ul style="list-style-type: none"> ● HMI Event Log File (.evt) / HMI Data Log File (.dtl) ● Comma Separated Values (.csv) <p>When back up event log in .csv format, open the csv file in EXCEL. The BOM (Byte Order Mark) can be added to the file header so that the .csv file containing non-ASCII strings can directly be opened in EXCEL. The title, export time, occurrence count, and elapsed time can be included or omitted in the backed-up .csv file.</p> <div data-bbox="496 1704 1291 1906" data-label="Image"> </div> <p>The [Event] column is included in the backup file to indicate the type of the event.</p>

	A	B	C	D	E
1	Event	Category	Date	Time	Message
2	0	1	2013/7/4	16:12:11	Event A
3	2	1	2013/7/4	16:12:12	Event A
4	0	0	2013/7/4	16:12:33	Event B
5	2	0	2013/7/4	16:12:36	Event B
6	0	0	2013/7/4	16:12:37	Event B
7	1	0	2013/7/4	16:12:37	Event B
8	2	0	2013/7/4	16:12:39	Event B
9	0	0	2013/7/4	16:12:40	Event B

0 = Event is triggered

1 = Event is acknowledged

2 = Event returns to normal

EasyConverter can be used to easily convert HMI Event Log File (.evt) and HMI Data Log File (.dtl) to .xls or .csv format.

- SQLite Database File (.db)

cMT Series:

- SQLite Database File (.db) (Only for backup to e-mail)
- Comma Separated Values (.csv)

Range

Historical data sampling

Select a number of files. For example, if [Start] is set to [Current], and [Within] is set to [5 file(s)], the latest five files in memory will be backed up.

Historical eventlog

Select a number of days. For example, if [Start] is set to [Yesterday], and [Within] is set to [2 day(s)], the files obtained yesterday and the day before yesterday will be backed up. Select [All] to save all files, and the maximum is 90 days.

Trigger

Mode

There are three ways to activate Backup function.

Touch trigger

Touch the Backup object to activate backup operation.

External trigger (bit)

Register a bit device to trigger the backup operation.

Select whether the backup operation is activated after Off to ON, ON to OFF transition, or at both of the changes of state.

External trigger (word)

Users can specify the number of days to backup data using [Trigger address]. [Trigger address] usage (suppose LW-n is used):

LW-n: Will start to back up when the value changes from 0 to 1.

LW-n+1: The start date of backup.

LW-n+2: The number of days for backup. (The maximum: 90 days).

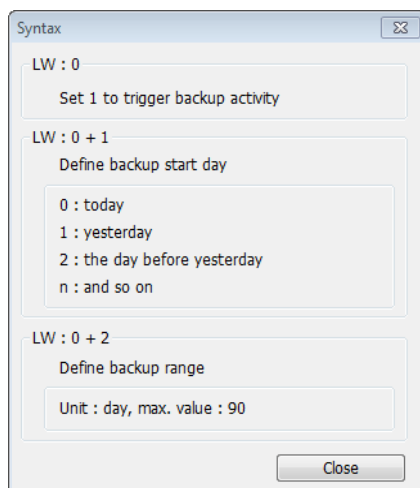

On cMT-SVR, Backup (Trigger-based) object only supports [Touch trigger] mode but not [External trigger (bit)] and [External trigger (word)] modes.

**Trigger
address**

When the state of the designated register is set ON, the backup operation is activated. When the backup operation is done, the state of the designated register is set OFF.

 **Note**

- All history files should have been saved in memory, either HMI memory, USB disk or SD card. Otherwise, the Backup object will not work.
- The maximum number of days for backup is 90 days. (Not including cMT Series)
- When saving files to USB disk or SD card, the capacity of a FAT32 folder depends on the length of the file names. Fewer files can be saved when the file names are longer.

 For cMT Series, see “7 Event Log” and “8 Data Sampling” that explain the mechanism of synchronizing data to external device.

Advance Tab

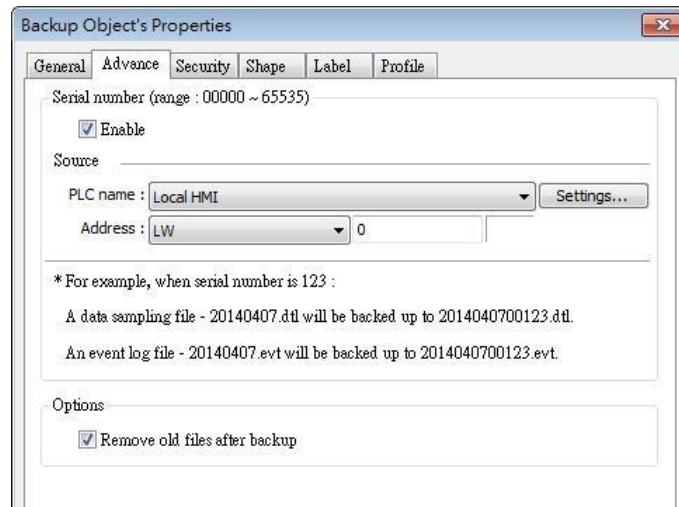

Setting	Description
Serial number	<p>If enabled, when backing up history files, a user-defined, 5-digit serial number can be appended to the end of the file name of the history data backup.</p> <p>The serial number is determined by the value in the designated source address. After backup, the value of this LW address will automatically increment by 1.</p> <p>The range of the serial number is 0~65535</p> <p>For example, if the serial number is 123, the appended 5 digits will be 00123.</p> <p>A data sampling file -20140407.dtl will be backed up as 2014040700123.dtl.</p> <p>An event log file -20140407.evt will be backed up as 2014040700123.evt.</p>
Options	<p>Remove old files after backup</p> <p>If selected, the old history files will be removed after backup.</p>

 **Note**

- cMT Series does not support Advance settings.

e-Mail Tab

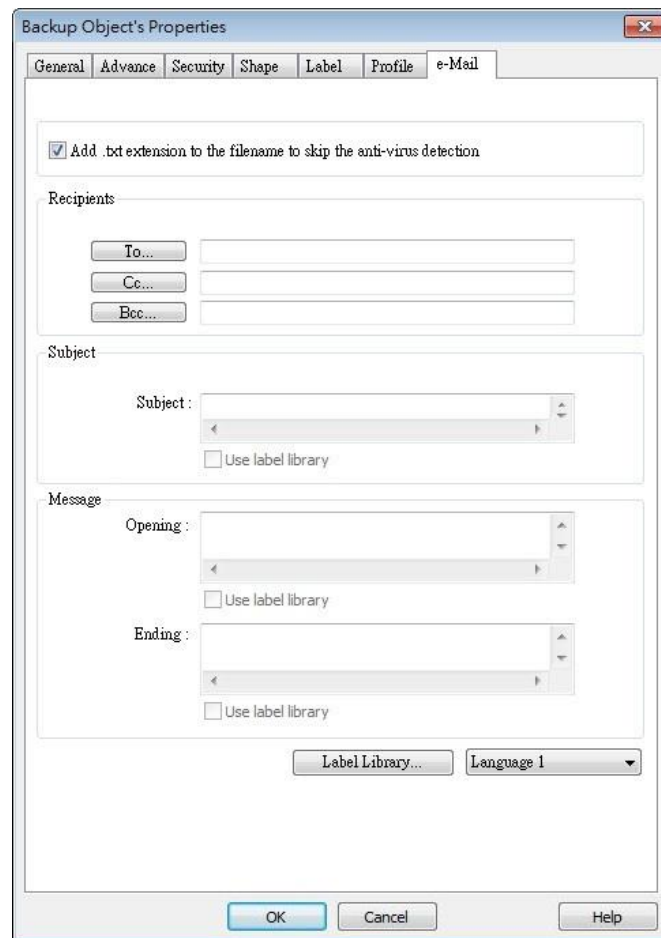

Setting	Description
Add .txt extension to the filename to skip the anti-virus detection	If selected, when sending backup data as an email attachment, the filename extension .txt will be added to the file name. This prevents the mail server or anti-virus software from blocking emails.
Recipients, Subject, Message	Back up the email address of the recipients, the subject of the email, and the message content.

13.25. Media Player

13.25.1. Overview

At the first time using Media Player object in the project, download the project to HMI via Ethernet. EasyBuilder Pro installs Media Player driver automatically.

Media Player object plays video files with controls such as seek, zoom, and volume adjustment to provide maintenance instructions or procedures on video so as to enable on-site operators to perform tasks efficiently.

13.25.2. Configuration



Click the Media Player icon on the toolbar to open a Media Player object property dialog box. Set up the properties, press OK button, and a new Media Player object will be created.

General Tab

Setting	Description
Control address	<ul style="list-style-type: none"> Selected Designate a word register to control the object operations.

- Not selected

No manual control. Video will be played automatically when the designated window opens.

Command (control address + 0)

Enter a value in the Command register to designate which action is executed.

Parameter 1 (control address + 1)

Enter a value in Parameter 1 associated with each command action.

Parameter 2 (control address + 2)

Enter a value in Parameter 2 associated with each command action.

Status (control address + 3)

Indicates the status or errors.

File index (control address + 4)

The file number in the designated folder. It is recommended to file the video name with a number.

Start time (control address + 5)

The start time of the video (second). 0, normally.

End time (control address + 6)

The end time of the video (second). (The time length of the video)

Update video playing time

If enabled, the elapsed playing time of video will be written into [Playing time] register at a rate set by [Update period] in seconds.

Update period

Update period of [Playing time], range from 1 to 60 (second).

Playing time (control address + 7)

The elapsed playing time of video (Second). Normally between start time and end time.

Ext. device

Play video files in SD card / USB disk.

Folder name

The folder name of video files stored in SD card or USB disk. Files must be stored in root directory. Subdirectories won't be accepted. (For example, "example\ex" is an invalid directory.)

[Folder name] cannot be empty, must be alpha-numeric, and all in ASCII character.

Attribute

Auto. repeat

When finish playing all the video files, replay from the first file.

Ex: Video 1 > Video 2 > Video 1 > Video 2

Background

The background color of the object.

Note

- The data format for control address is 16-bit Unsigned or 16-bit Signed. If using 32-bit

Unsigned or 32-bit Signed, only the previous 16 bits will be effective.

Control command

The following are the settings of different commands.

- **Play index file**

[Command] = 1

[Parameter 1] = file index

[Parameter 2] = ignore (set 0)

Note

- Files are stored with file names in ascending order.
- If the file cannot be found, [Status] bit 8 is set ON.
- Please stop the playing video before switching to another.

- **Play previous file**

[Command] = 2

[Parameter 1] = ignore (set 0)

[Parameter 2] = ignore (set 0)

Note

- If [File index] is zero, the same file is replayed.
- If the file cannot be found, [Status] bit 8 is set ON.

- **Play next file**

[Command] = 3

[Parameter 1] = ignore (set 0)

[Parameter 2] = ignore (set 0)

- If there are no more files, the index 0 file is played.
- If the file cannot be found, [Status] bit 8 is set ON.

- **Pause / Play Switch**

[Command] = 4

[Parameter 1] = ignore (set 0)

[Parameter 2] = ignore (set 0)

- **Stop playing and close file**

[Command] = 5

[Parameter 1] = ignore (set 0)

[Parameter 2] = ignore (set 0)

- **Start playing from the designated time**

[Command] = 6

[Parameter 1] = target time (second)

[Parameter 2] = ignore (set 0)

 **Note**

- Parameter 1 (target time) must be less than the ending of time or it plays the last second.

- **Forward**

[Command] = 7

[Parameter 1] = target time (second)

[Parameter 2] = ignore (set 0)

 **Note**

- Going forward to the designated second in [Parameter 1]. If the video is paused, the forwarding action will be started by playing.
- When the designated time is later than the end time, it plays the last second.

- **Backward**

[Command] = 8

[Parameter 1] = target time (second)

[Parameter 2] = ignore (set 0)

 **Note**

- Going Backward to the designated second in [Parameter 1], if the video is paused, the backward action will be started by playing.
- When the designated time is earlier than the beginning time, it plays from beginning.

- **Adjust volume**

[Command] = 9

[Parameter 1] = volume (0 ~ 128)

[Parameter 2] = ignore (set 0)

 **Note**

- Default volume is 128.

- **Set video display size**

[Command] = 10

[Parameter 1] = display size (0 ~ 16)

[Parameter 2] = ignore (set 0)

 **Note**

- [Parameter 1 = 0] : Fit video image to object size.
- [Parameter 1 = 1 ~ 16] : Magnification from 25% ~ 400% in 25% increments where 1 = 25%, 2 = 50%, 3 = 75% and so on.

- **Status (control address + 3)**

When playing a video the system sets [File Open (bit00)] and [File Playing (bit01)] to ON. If the file cannot be found, or an invalid command is entered, the Command Error bit 08 is set ON. If the file format is not supported, or a disk I/O error occurs, during playback (for example, USB disk unplugged), the File Error bit 09 is set ON.

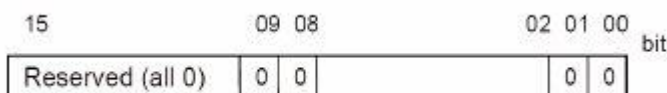

- 00: File Opened / Closed (0 = closed, 1 = opened)
- 01: File Playing (0 = not playing, 1 = playing)
- 08: Command Error (0 = accepted, 1 = incorrect)
- 09: File Error (0 = accepted, 1 = incorrect)

 **Note**

- The figure shows the status value associated with each state:
Stop = 0, Pause = 1, Playing = 3



- [Command], [Parameter 1], and [Parameter 2] are write addresses. All others are read only.

Preview Tab

Users can test whether the video format is supported by using the preview function.



Setting	Description
Forward << / Backward >>	Go forward or backward of the video. (in minutes)
Play / Pause	Select to start playing video or pausing.
Stop	Stop playing and close the video file. To test another video, please stop playing the current video first.
Load	Select a video to preview.

Note

- Only one video file can be played at one time.
- If [control address] is not enabled and [Auto. repeat] is not selected, after finish playing the first file, the system will stop playing and close the video file.
- If [control address] is not enabled, the system will find the first file in the designated folder and start to play (in ascending order of the file name).
- If the file can be previewed, the format is supported. If the video image quality is poor, please adjust the resolution.
- The supported formats: mpeg4, xvid, flv...etc.



Click the icon to download the demo project. Please confirm your internet connection before downloading the demo project.

13.26. Data Transfer

13.26.1. Overview

Data Transfer object has similar function compared to Trigger-based Data Transfer object. They transfer the data from source to destination register. The difference is that Data Transfer object transfers data based on time schedule, and is able to transfer data in bits.

When using cMT Series, Data Transfer object is divided into two modes: [Time-based] and [Bit trigger]. In these two modes, the system automatically detects the state of the designated bit register and executes data transfer. [Time-based] mode is the same as described earlier, where [Bit trigger] mode transfers data when the state of the designated bit register changes. For the detail of [Bit trigger] mode, see “13.26.2.2 Data Transfer Bit Trigger”.

13.26.2. Configuration



Click Data Transfer icon on the toolbar to open the Data Transfer management dialog box. Click [New] and configure the properties. All the defined Data Transfer can be viewed from the dialog box as shown in the following figure.

eMT, iE, XE, mTV Series

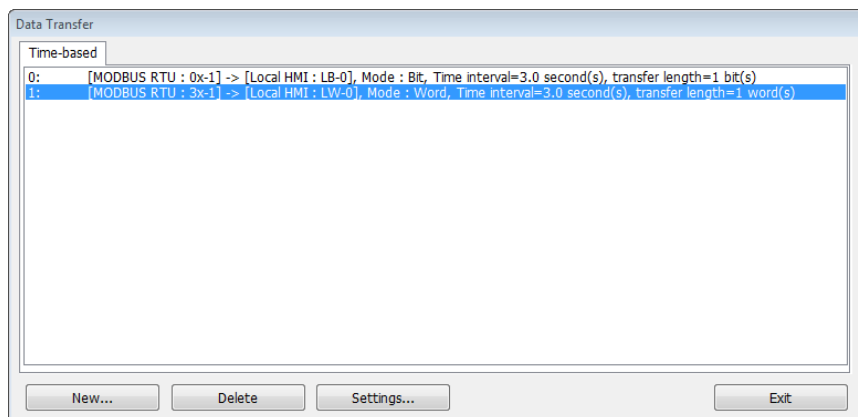

cMT Series

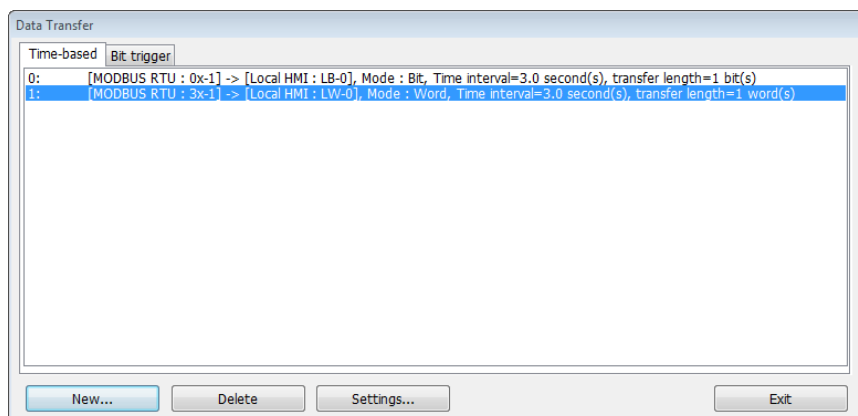

13.26.2.1. Data Transfer Time-based

General Tab

Click the [New] button in the Data Transfer management dialog box.

Setting	Description
Attribute	<p>Address type Select the data type, either [Bit] or [Word].</p> <p>No. of bits /No. of words When [Bit] is selected in [Address type], set the number of bits transferred each time when data transfer is triggered. When [Word] is selected in [Address type], set the number of words transferred each time when data transfer is triggered.</p> <p>Interval Select the time interval of data transfer, for example, when 3 seconds is set, the system will transfer data every 3 seconds. Specifying a short time interval or a big number of data to transfer may cause an overall performance of system decrease. Therefore, it is recommended that users choose a longer time interval and a smaller amount of data to transfer. When a short interval is inevitable, be aware of the interval must be longer than the data transfer operation. For example, if the data transfer operation takes 2 seconds, set the interval longer than 2 seconds.</p>

Activate only when designated window opened	Data Transfer object transfers data only when the designated window is opened.
Source address	Data Transfer object reads the data from [Source Address].
Destination address	Data Transfer object writes the data to [Destination Address].
Notification	When enabled, the system will set the designated address ON or OFF when it's ready for data transfer. Follow The notification bit will reset to its original state once the system starts data transfer.

13.26.2.2. Data Transfer Bit Trigger

General Tab

Click the [New] button in the Data Transfer management dialog box, and open [Bit trigger] tab.

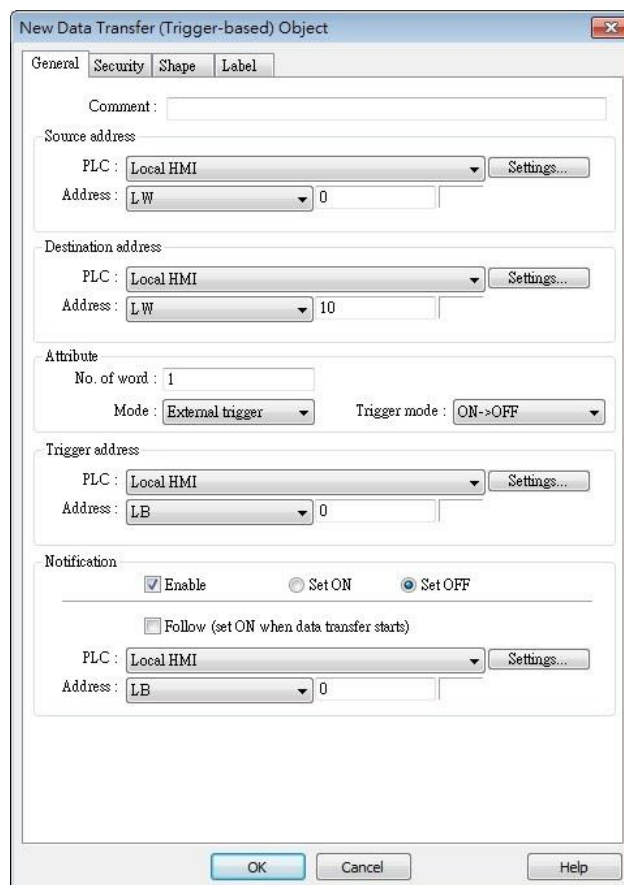

Setting	Description
Source address	Data Transfer object reads the data from [Source Address].
Destination address	Data Transfer object writes the data to [Destination Address].
No. of word	Set the number of words transferred each time when data transfer is triggered.
Trigger address	<p>Set the register that controls data transfer and select the trigger mode.</p> <p>Trigger mode</p> <p>Trigger data transfer when the state of the designated register changes from Off to ON, ON to OFF, or at both of the changes of state.</p>
Notification	<p>When enabled, the system will set the designated address ON or OFF when it's ready for data transfer.</p> <p>Follow</p> <p>The notification bit will reset to its original state once the system starts data transfer.</p>

13.27. PLC Control

13.27.1. Overview

PLC Control object can execute commands when it is triggered.

13.27.2. Configuration



Click the PLC Control icon on the toolbar to open the PLC Control Object management dialog box. To add a PLC Control object, click [New], set up the properties, press OK button and a new PLC Control object will be created.

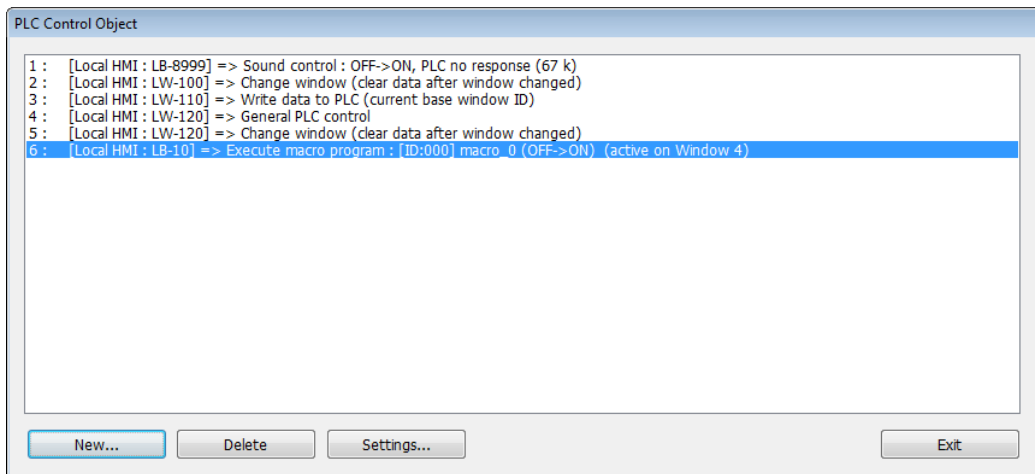

Click [New] and the following dialog box appears. See “13.27.2.1 Type of Control”.

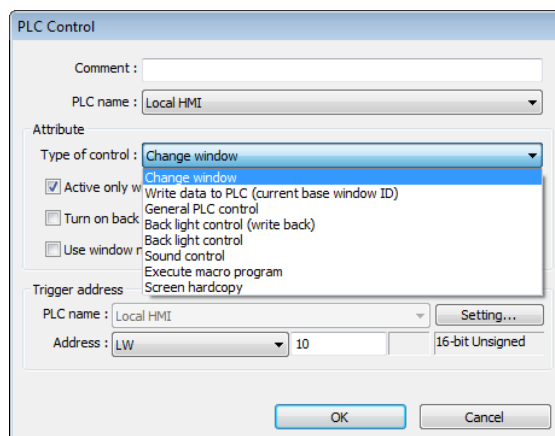

Note

- The [PLC Control] and [Backlight Control] options are not available for cMT Series.

13.27.2.1. Type of Control

- **Change window**

Setting	Description
Active only when designated window opened	Allow this operation only if a particular screen is displayed.
Turn on back light	The backlight is turned ON when the window object is changed. (Not available for cMT Series)
Clear data after window changed	Reset the value at trigger address to zero when the window object is changed. If [Use window no. offset] is selected, this option will only show when a negative offset is used.
Use window no. offset	Select the check box and select a window offset, the new window no. to change to will be the value in [Trigger address] plus the offset. For example, if [Trigger address] is LW-0 and offset is set to -10. When the value in LW-0 is 25, the system will change to window no. 15 (25-10=15). The range of the offset is -1024 to 1024.

Note

- If [LB-9017] is set ON, the write-back function will be disabled, the new window number is not written back into a designated address.

Place a valid window number in the designated trigger address to change the base screen to the new window number. The new window number is written back into the designated address.

For example, if current window is window no. 10, and [Trigger address] is set to LW-0, When LW-0 is changed to 11, the system will change the current window to window no. 11,

and then write 11 to LW-1.

When the window is changed, the new window number is written back into the address that is calculated by [Trigger address] and the data format, as shown in following table.

Data Format	Trigger address	Write address
16-bit BCD	Address	Address + 1
32-bit BCD	Address	Address + 2
16-bit Unsigned	Address	Address + 1
16-bit Signed	Address	Address + 1
32-bit Unsigned	Address	Address + 2
32-bit Signed	Address	Address + 2

- **Write data to PLC (current base window)**

Each time the base window is changed, the new window number will be written into the [Trigger address]. If [Use window no. offset] is selected, the window number of the base window plus the window number offset will be written into the [Trigger address].

- **General PLC Control (eMT, iE, XE, mTV)**

Transfer word data blocks from PLC to HMI, and vice-versa, and the transfer direction is controlled by the value in the [Trigger address].

Value in [Trigger address]	Action
1	Transfer data from PLC register → HMI RW register
2	Transfer data from PLC register → HMI LW register
3	Transfer data from HMI RW register → PLC register
4	Transfer data from HMI LW register → PLC register

Four consecutive word registers are used as described in the following table:

Address	Purpose	Description
[Trigger address]	Determine the direction of data transfer	The valid values are listed in the above table. When a new control code is written into the register, HMI will start to transfer. After data transfer is finished, the value will be set to 0.
[Trigger address] +1	The size of data to transfer.	The unit is word.
[Trigger address] +2	Offset to the start address of	Assume the value is “n”, where n is an arbitrary number, the start

	PLC register	address of PLC register is [Trigger address + 4 + n]. Take an OMRON PLC as an example: If [Trigger address] uses DM-100, [Trigger address + 2] will be DM-102. If the value in DM-102 is 5, the start address of data source would be DM-109 (100 + 4 + 5 = 109).
[Trigger address] +3	Offset to the start address of LW or RW memory in HMI	Take OMRON PLC as an example: If set [Trigger address] to DM-100, [Trigger address + 3] will be DM-103. If the value in DM-103 is 100, the start address of memory in HMI is RW-100 or LW-100.

Example 1

To use PLC Control object to transfer 16 words data in OMRON PLC, starting from address DM-100, to the HMI address, starting from RW-200. The setting is shown below:

1. Firstly, create a PLC Control object, set [Type of control] to [General PLC control], and set [Trigger address] to DM-10, that is, to use the four sequential registers start from DM-10 to control data transfer.
2. Confirm the data size and the offset addresses.
Set DM-11 to 16, since the number of words to transfer is 16 words.
Set DM-12 to 86, which indicates the address of data source is DM-100 (100=10+4+86).
Set DM-13 to 200, which indicates the destination address is RW-200.
3. Set DM-10 according to the direction of data transfer.
If set DM-10 to 1, the data will be transferred from PLC to HMI RW register,
If set DM-10 to 3, the data will be transferred from HMI RW register to PLC.

- **Back light control (write back) (eMT, iE, XE, mTV)**

When [Trigger address] is turned ON, HMI backlight will be turned ON/OFF and [Trigger address] will be turned OFF. Any touch on the screen will turn the backlight on.

- **Back light control (eMT, iE, XE, mTV)**

When [Trigger address] is turned ON, HMI backlight will turn ON/OFF and the state of [Trigger address] will not be changed.

- **Sound control**

When the state of the designated [Trigger address] changes, the HMI will play the sound selected from the sound library. There is a further selection determines whether the sound is played after Off to ON, ON to OFF transition, or at both of the changes of state.

- **Execute macro program**

Select a pre-defined Macro from the drop-down list. When the state of the designated [Trigger address] changes, the selected Macro is executed. There is a further selection determines whether the Macro is executed after Off to ON, ON to OFF transition, or at both of the changes of state. If select [Always active when ON], the macro will be executed repeatedly. (The shortest time interval between runs is 0.5 second.)

- **Screen hardcopy**

The screenshot shows the 'PLC Control' dialog box with the following settings:

- Comment:** (Empty text field)
- PLC name:** Local HMI (Dropdown menu)
- Attribute:**
 - Type of control:** Screen hardcopy (Dropdown menu)
 - Active only when designated window opened
 - Rotate image 90 degrees
- Trigger address:**
 - PLC name:** Local HMI (Dropdown menu) with a 'Settings...' button
 - Address:** LB (Dropdown menu) and 0 (Text field)
- Screen hardcopy:**
 - Trigger mode:** OFF->ON (Dropdown menu)
- Source window for print:**
 - Current base window
 - Window no. from register
 - Designate window no.
- Printer:** SD card (Dropdown menu)
- Customized filename handling with a 'Settings...' button
- Buttons:** OK and Cancel

When the state of the designated [Trigger address] changes, print the selected screen. If select [SD card] or [USB disk] as [Printer], a "hardcopy" folder will be generated in the selected external device for saving the printed screen in JPG format. The name of the JPG files starts from yyyyymmdd_0000.

To print the screen using a printer, go to System Parameter Settings » Model tab and set the printer.

To print the screen using a remote printer, go to System Parameter Settings » Printer/Backup Server tab and configure the parameters.

There are three options to specify the source window for hardcopy:

Current base window

Print the base window currently opened.

Window no. from register

Print the window designated by the value in a designated word address.

Designate window no.

Directly select a window to be printed.

Customized File Handling

This feature can be used to customize naming of the folders and the JPG files.

Setting	Description
Folder name	<p>The folder name can be an alphanumeric name, and certain half-width symbols are allowed: !@#\$%^&()_+{}`-=';,. The folder name can also be specified by a naming syntax.</p> <p>Dynamic format</p> <p>The folder names can be set by a designated word address, or by a naming syntax indicating the current system time. The syntax can be specified by selecting time buttons or entering the syntax in Format field. The length limit is from 1 to 25.</p> <p>Note: Up to 10 layers of folders can be created. The exceeding layers will be ignored.</p>
File name	<p>The way to specify a file name is similar to specifying a folder name.</p> <p>Note: If the file name already exists, the system will add “_0001” to the file name as a serial number. The numbers of the later files add up until “_9999”. The files after “_9999” will be ignored.</p> <p>For example, if the three file names exist: “A.jpg”, “A_0001.jpg”, “A_0003.jpg”. When trigger screen hardcopy with the same file name, the coming files will be named in this order: “A_0002.jpg”, “A_0004.jpg”, “A_0005.jpg”, and so on.</p>

 **Note**

- The [Printer] setting is not available for cMT Series. The window hardcopy file is saved in iPad Photo folder.

- A background printing procedure is performed when the printed window is not the current base window.
- If the hard-copied window is a background window, its [Direct Window] and [Indirect Window] objects will not be printed.
- When using a dynamic format name, the system will use a “_” sign as a substitute for invalid symbols.
- When using a dynamic format name, if screen hardcopy is triggered without specifying the format first, the system will save the file in the default directory, which is:
hardcopy\yyymmdd_0000.JPG

13.28. Scheduler

13.28.1. Overview

Scheduler object turns bits ON/OFF, or writes values to word registers at designated start times. It works on a weekly basis.

13.28.2. Configuration

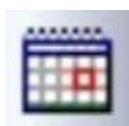

Click the Scheduler icon on the toolbar to open the Scheduler management dialog box, click [New] to open the Scheduler property setting dialog box.

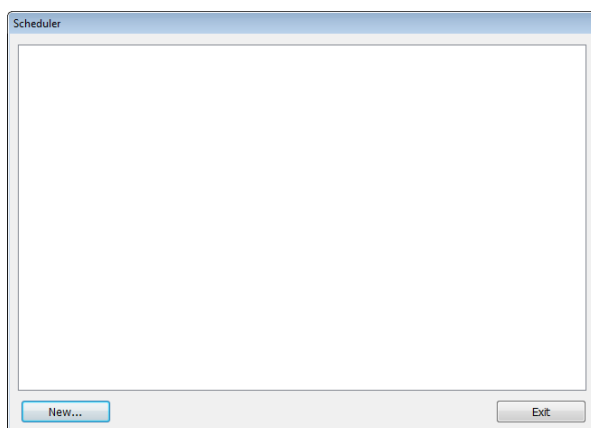

The following two demonstrations explain the usage of Scheduler.

Example 1

A motor is scheduled to power - ON at 9:00 and power – OFF at 18:00, Monday to Friday. We are using LB-100 to control the motor state. LB-100 will be set ON at 9:00 and OFF at 18:00.

1. Click the Scheduler icon on the toolbar to open the Scheduler management dialog box, click [New].
2. In [General] tab, select [Bit ON] in [Action mode] and set [Action address] to LB-100.

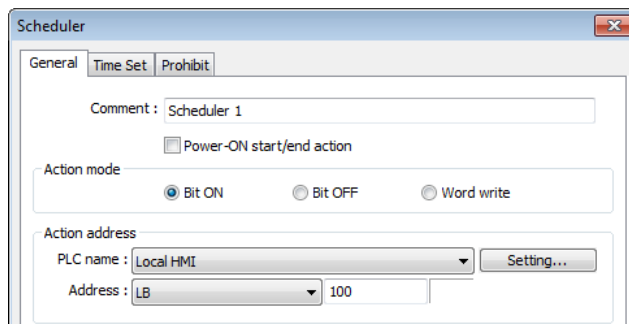

3. In [Time Set] tab, select [Constant].

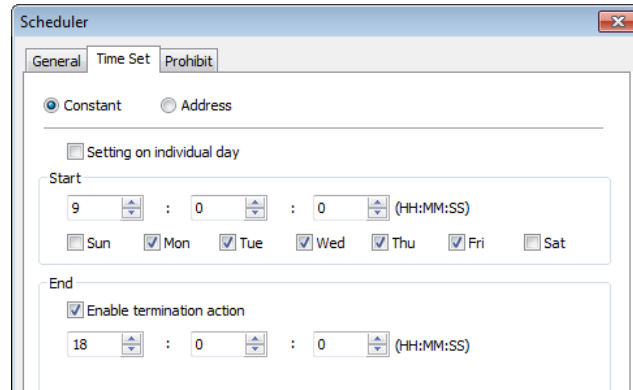

4. Enter [Start] time as 9:00:00 and select Monday to Friday. Do not select [Setting on individual day].
5. Enter [End] time as 18:00:00 and select [Enable termination action] check box.
6. Click [OK], a new Scheduler object will be created on the [Scheduler] list.

Example 2

A thermal heater is scheduled to heat up to 90°C at 08:00 and cool down to 30°C at 17:00, Monday to Friday. LW-100 is used to store the set point value.

1. Click the Scheduler icon on the toolbar to open the Scheduler management dialog box, click [New].
2. In [General] tab, select [Word write] in [Action mode] and set [Action address] to LW-100.
3. Select [Constant] for [Word write value settings] and enter 90 in [Start value].

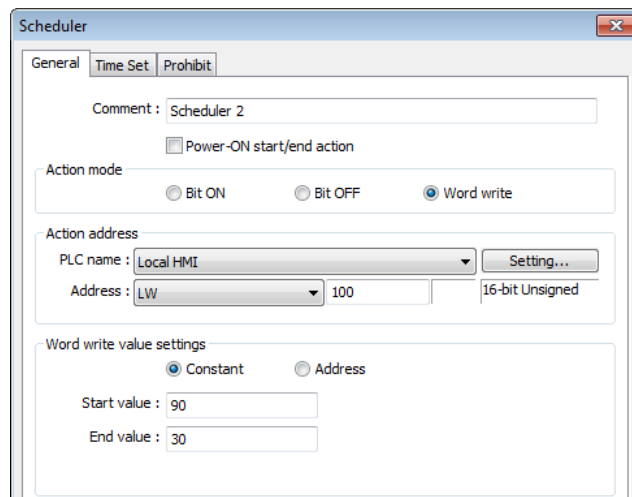

4. In [Time set] tab select [Constant].
5. Enter [Start] time as 8:00:00 and select Monday to Friday. Do not select [Setting on individual day].
6. Enter [End] time as 17:00:00 and select [Enable termination action] check box.
7. Return to [General] tab and enter 30 in [End value].
8. Click [OK], a new schedule object will be created on the [Scheduler] list.

General Tab

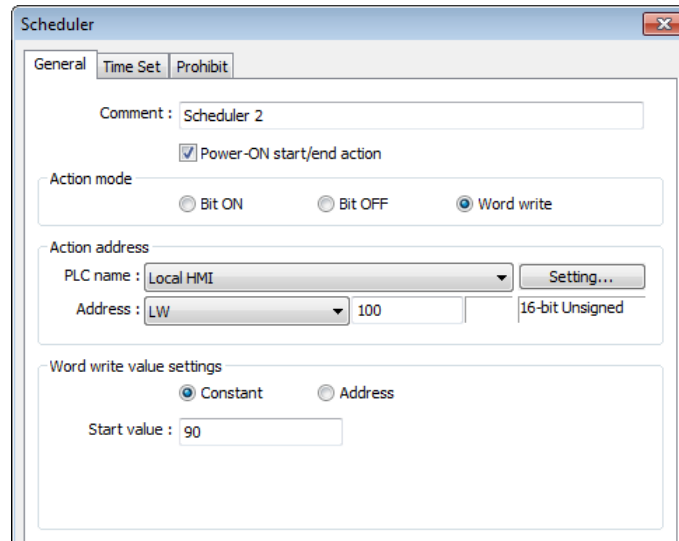

Setting	Description
Power ON start/end action	<p>Execute the defined action when the HMI is powered ON.</p> <ul style="list-style-type: none"> ● Enabled <p>When HMI is powered ON within the scheduled time range, the start action will be performed automatically. When HMI is powered ON outside the scheduled time range, the termination action will be executed.</p> <p>Inside scheduled range</p> <p>Outside scheduled range</p> <ul style="list-style-type: none"> ● Disabled <p>When the HMI is powered ON at a time later than the start time, the start action will not be performed, but the termination action will be performed. When the termination action is not defined, the scheduled range is not recognized and no action is performed.</p>

Action mode

Choose the action to do at the given time.

Bit ON

At the start time, set the designated bit ON. At the end time, set the designated bit OFF.

Example: Start time : 09:00:00 End time : 17:00:00

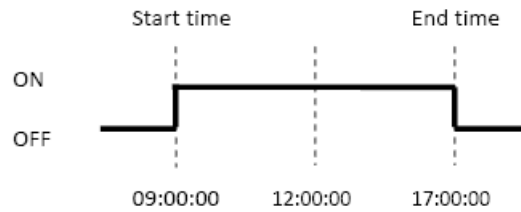

Bit OFF

At the start time, set the designated bit OFF. At the end time, set the designated bit ON.

Example: Start time : 09:00:00 End time : 17:00:00

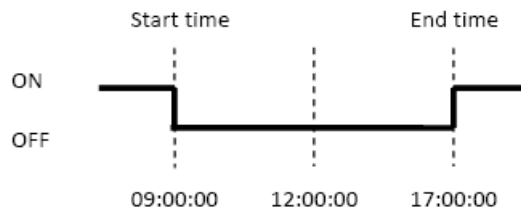

Word write

The [Write start value] entered here is transferred to the designated [Action address] word register at the start time. At end time, the [Write end value] entered here is written to the [Action address]. The valued can be entered manually or be set by using [Address] mode. In [Address] mode, the value in the specified address is the start value where the value in [Address + 1] is the end value.

Example: Device address: LW-100

Start time: 09:00:00 End time: 17:00:00

Write start value: 10 Write end value: 0

Use register: If control address is LW-n, then enter 10 in LW-n and enter 0 in LW-(n+1).

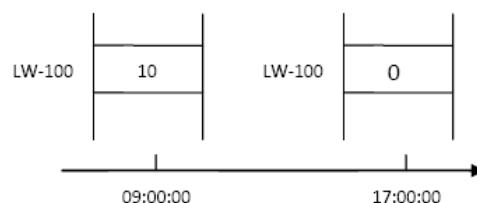

 **Note**

- Only if an [End time] is set in the [Time set] tab will the [Write end value] box appear.

Time Set

Specify start time and end time. [Constant] allows specifying a date or period and time. [Address] allows controlling the time by the designated address.

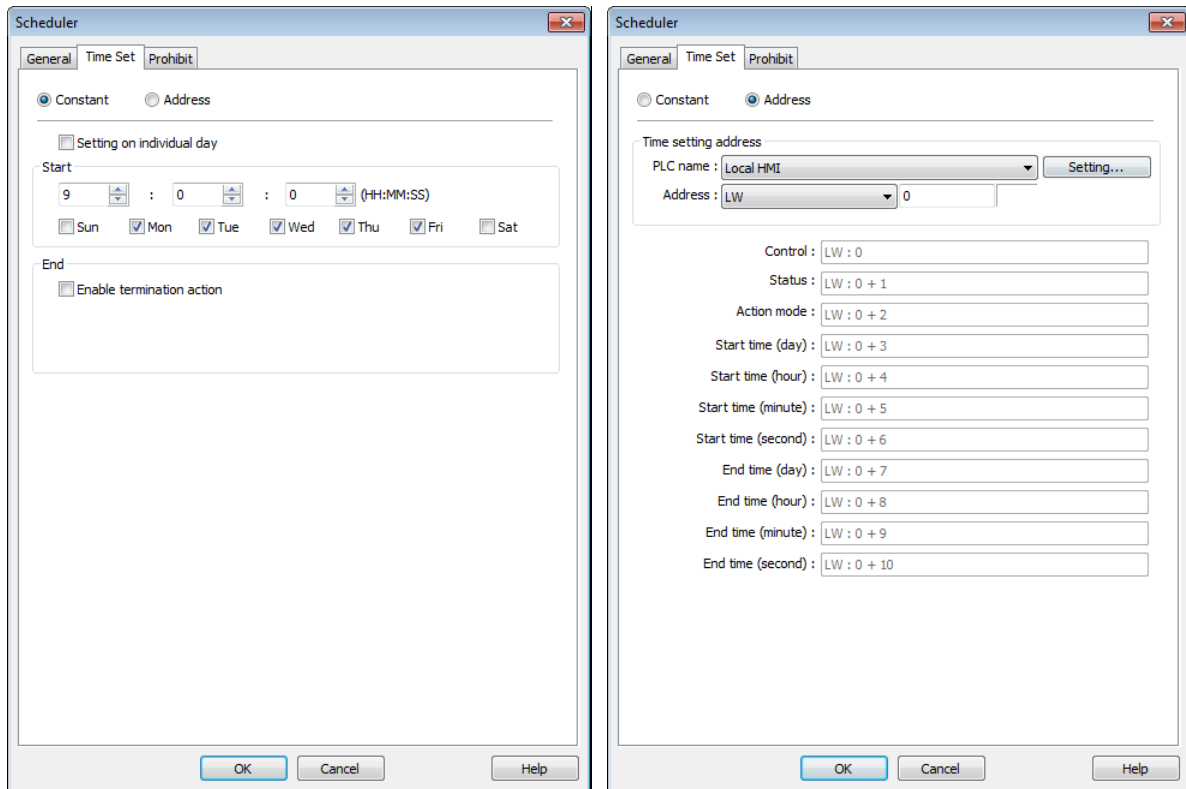

● **Constant**

Setting on individual day

If [Setting on individual day] is selected

The same start time and end time can be assigned to different days of the week.

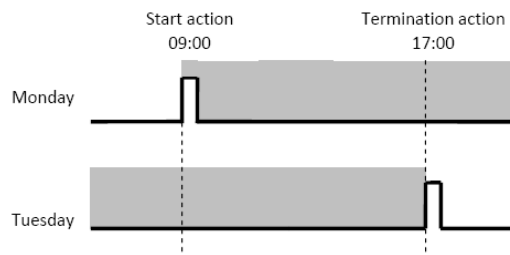
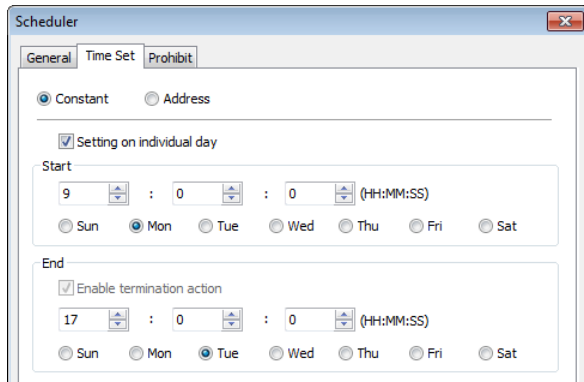

 **Note**

- Start and end time must be entered.
- Start and end time must be on a different time, or same time but different day.

If [Setting on individual day] is not selected

Start time and end time entered must start and end within 24-hours.

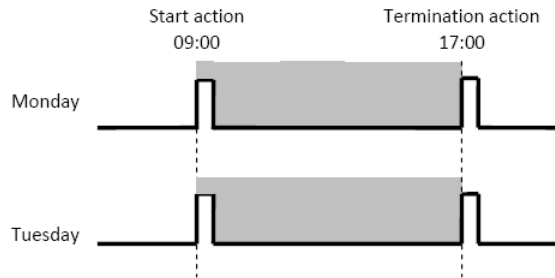
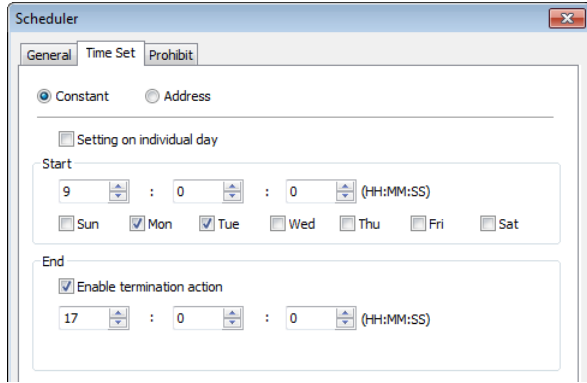

 **Note**

- Start time and end time must be on a different time, different day.
- If an end time is earlier than a start time, the end action will occur in the next day.

Start date: Monday
 Start time: 22:00
 End time: 01:00

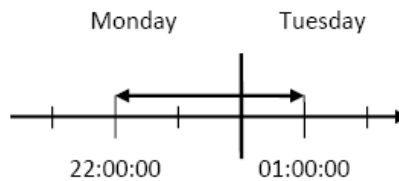

● **Address**

The scheduler object retrieves the start/end time and day of week information from word registers, enabling all parameters to be set and changed under PLC or user control. Designated as the top address in a block of 11 sequential registers which are used to store time setting data.

The format of the 11 word registers should normally be 16-unsigned integer. If a 32-bit word address is chosen, only bits 0-15 are effective, and bits 16-31 should be written as zero.

The following describes each register.

Control (Time setting address + 0)

When [Control] bit is ON, the HMI will read and update [Action mode], [Start time], and [End time] values.

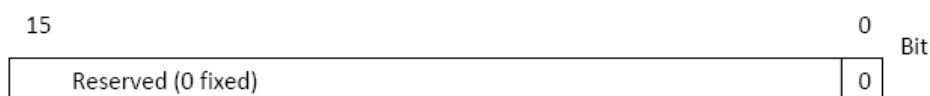

Bit 0: no action 1: read times/action mode

 **Note**

- HMI will not regularly read the data from [Action mode] (address + 2) to [End time] (address + 10). Please turn [Control] ON when the settings are changed.

Status (Time setting address + 1)

When the read operation is completed, Bit00 of this register turns ON. If time data read is out of range or incorrect in any way Bit01 turns ON.



Bit 00: Status bit: Read operation completed. (0: reading or reading not started. 1: reading completed.)

Bit 01: Error bit: Start or end time format incorrect. (0: corrected 1: error)

 **Note**

- After the scheduler reads the data and the status is turned ON (The value in [Address + 1] = 01), the control bit must be turned OFF (address = 0). The status bit and error bit will be turned OFF (1→0) at the same time.

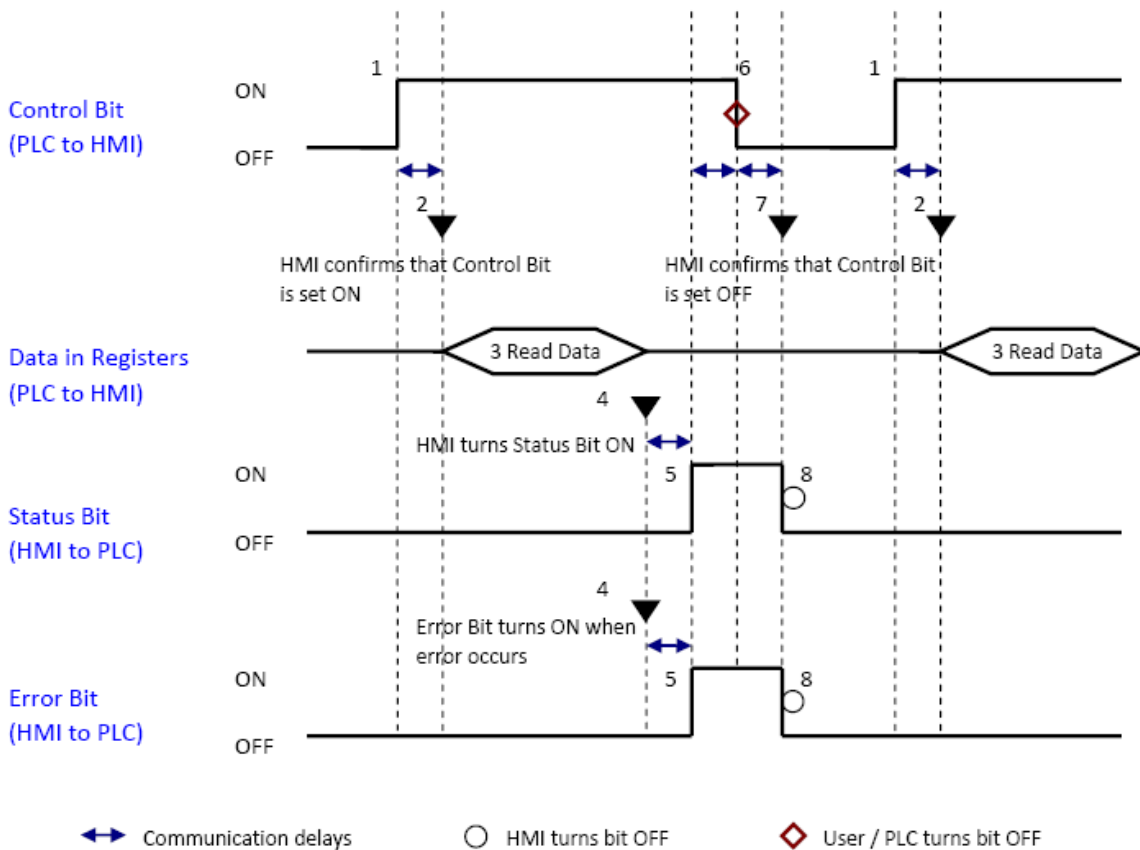

Action mode (Time setting address + 2)

Enable/disable [Enable termination action] and [Setting on individual day]. Whatever the [Enable termination action] bit is, all the time data, from [Control] to [End time (second)], will be read.



Bit 00 Enable termination action (0: Disabled 1: Enabled)

Bit 01 Setting on individual day (0: Disabled 1: Enabled)

 **Note**

- If [Enable termination action] is OFF, all 11 registers are still read but end time is ignored.
- If [Setting on individual day] is ON, make sure that all start end times are entered. If more than one start / end day bit is ON, and error will occur.

Start/End Day (Start Day: Time setting address + 3, End Day: Time setting address + 7)

Designates which day of week is used to trigger the start or end action.

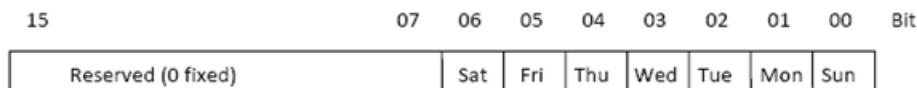

Bit 00 Sunday (0: not used 1: used)

Bit 01 Monday (0: not used 1: used)

Bit 02 Tuesday (0: not used 1: used)

Bit 03 Wednesday (0: not used 1: used)

Bit 04 Thursday (0: not used 1: used)

Bit 05 Friday (0: not used 1: used)

Bit 06 Saturday (0: not used 1: used)

Start/End Time (Start Time: Time setting address + 4 to + 6, End Time: Time setting address + 8 to + 10)

Hour: 0 – 23 Minute: 0 – 59 Second: 0 - 59

Values outside these ranges will cause error.

 **Note**

- 16-bit unsigned integer format must be used; BCD format is not supported here.
- End time depends on [Action mode] (address + 2). [Enable termination action] (Bit 00) and [Setting individual day] (Bit 01) are related:

Setting individual day	Enabled	Disabled	
Enable termination action	Enabled	Enabled	Disabled

Prohibit tab

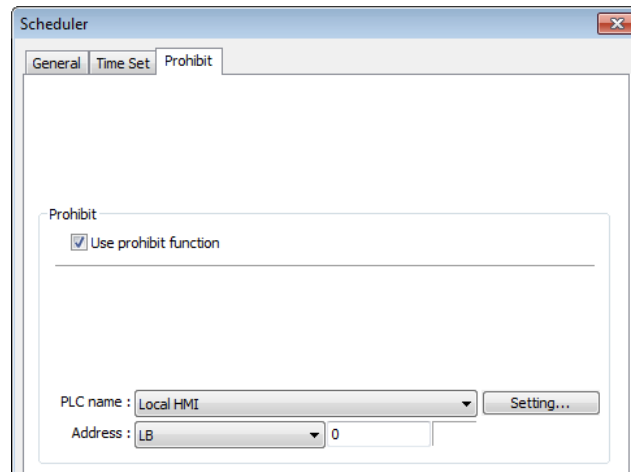

Before the scheduled action is performed, the HMI will read the specified bit state. If it is ON, the scheduled start/end action will be skipped. Otherwise, it will be performed normally.

Note

- Up to 32 scheduler objects are allowed.
- A time schedule applies one action only when the start time is reached.

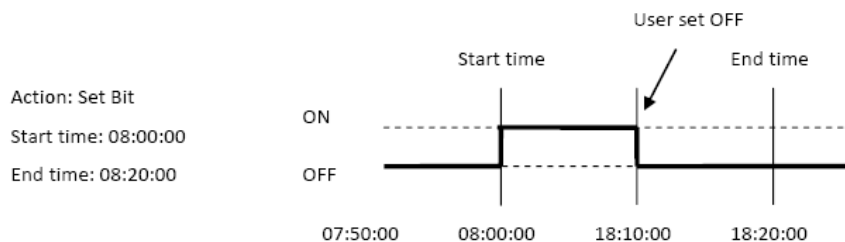

- [Write start/end value] and [Prohibit] bit is read only once before start action. After that, even to change the state of [Prohibit] bit or [Write start/end value], the end action and the value written will not be affected. Also, to read data of [Write start/end value] and [Prohibit] bit, there is a delay of start action due to the communication.
- Each time RTC data is changed, scheduler list entries that possess both start and end times will be checked for in-range or out-range conditions. For in-range, the start action will occur. If the end action is not set, the new range is not recognized, the action will not occur.
- If several Scheduler objects are set to the same start time or end time, the action is performed in ascending order of the schedule number.
- In [Time Set] » [Address] mode, the system will read [Control] word regularly. The length of the period depends on the system.
- In [Time Set] » [Address] mode, when start time and end time is out- range, error occurs in the set action time. (Note: BCD is not an acceptable format)
- In [Time Set] » [Address] mode, the action will not start up until the first time the time data is successfully updated.

13.29. Option List

13.29.1. Overview

Option List object displays a list of items that the user can view and select. Once the user selects an item, the corresponding data will be written to a word register.

There are two forms of this object – [List box] and [Drop-down list]. The [List box] lists all items and highlights the selected one. The [Drop-down list] normally displays only the selected item. Once the object is pressed, the system will display a list (which is similar to list box) as shown in the following figure.

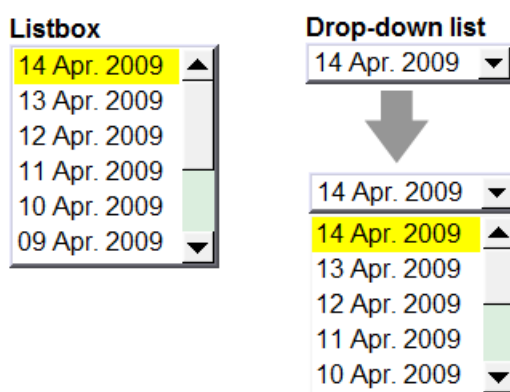

13.29.2. Configuration



Click the Option List icon on the toolbar to open an Option List object property dialog box. Set up the properties, press OK button, and a new Option List object will be created.

General Tab

Setting	Description
Attribute	<p>Mode: The list style, either [List box] or [Drop-down list].</p> <p>Item no.: Set the number of items for the object. Each item represents a state displayed in the list and the corresponding value will be written to the [Monitor address].</p> <p>Background: Set background color.</p> <p>Selection: Set background color for the selected item.</p> <p>Source of item data: There are 4 sources available: [Predefine], [Dates of historical data], [Item address], and [User account]. See 13.29.2.1..</p>
Monitor address	<p>The corresponding value of the selected item will be written to [Monitor address].</p> <p>Write when button is released</p> <p>If this check box is selected, the selected item value will be written to [Monitor address] after the button is released.</p>

Send notification after writing successfully	Set On/Off the designated bit address after successfully writing data to PLC.
---	---

Note

- For cMT Series, the [Dates of historical data] and the [write when button is released] selections are not available.

13.29.2.1. Source of item data

- **Predefine**

The list is manually defined in [Mapping] tab.

The number of items can be adjusted by [Item no.], and each item represents one state. Each item has a corresponding value which will be written to [Monitor address].

- **Dates of historical data**

This selection is not available for cMT Series.

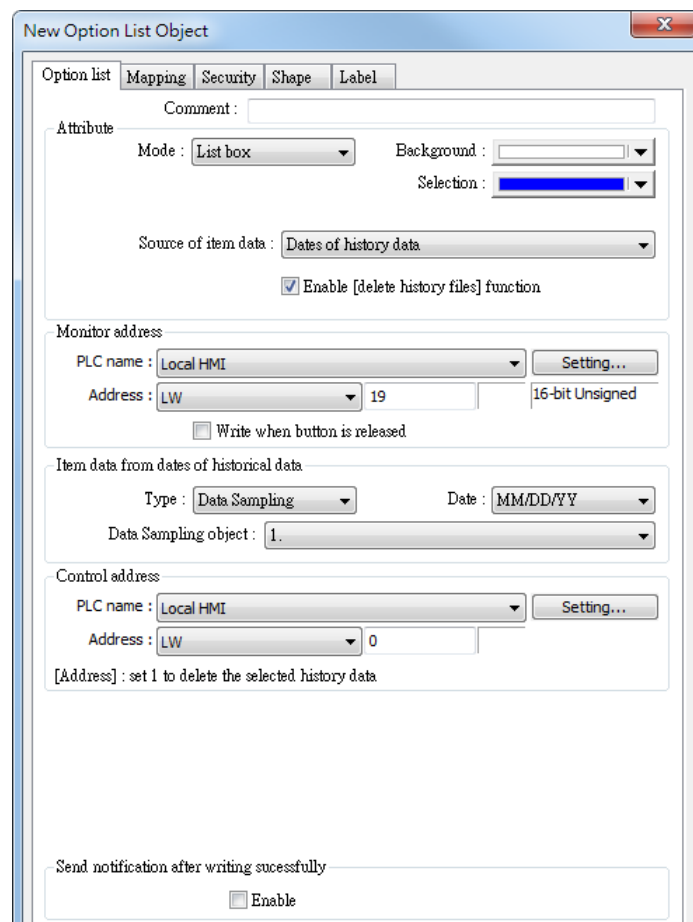

Option List object can be used with historical data display objects, such as Trend Display object, History Data Display object and Event Display object to control which history file should be

shown. The figure below is an example of Option List used with Trend Display.

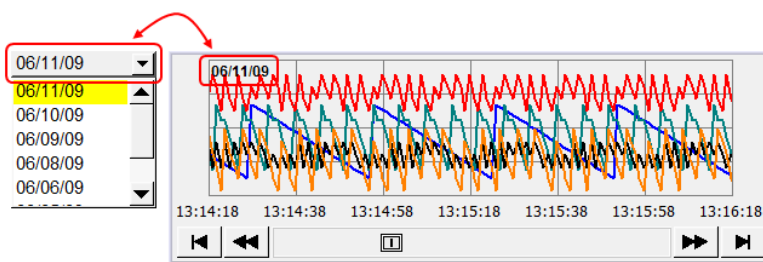

Setting	Description
Type	Two options are available: [Event (Alarm) log] and [Data sampling].
Date	Set the date format. YYYY means a four digits year (EX: 2012), YY means a two digits year (EX: 12), MM means month and DD means day.
Data Sampling object	Select which Data Sampling object is displayed when [Type] is [Data Sampling], and it should be the same as the [Data sampling object index] configured in [Trend Display] or [History Data Display].
Enable [delete history data] function	If selected, a control address can be set. Writing "1" to this address will delete the history data of the specified date.

Note

- In [Dates of historical data] mode, since the system automatically reads the historical data and finds the date information, it is not necessary to configure in the [Mapping] tab.
- The error message displayed in Option List can be modified in [Mapping] tab.

Item	Value	Item data
▶ 0 (error)		Error!!

● Item address

The list will be read from the given [Item address] and controlled by [Control address]. The following options will be available:

Setting	Description
Control address	[Address]: If the value at this address is changed to 1, the option list would be replaced by items defined at [Item address]. After updating, the value will be restored to 0. [Address + 1]: Define the number of items in [Item address].
Item address	Assign the item address UNICODE The item will use UNICODE characters, such as Chinese characters. The length of each item Define the number of letters for each item, the unit is Word.

Note

- The UNICODE characters used here should be used by Text object, so that EasyBuilder Pro will compile the needed fonts and download these fonts to HMI, then the UNICODE letters can be correctly displayed.
- [The number of items] multiplied by [The Length of each item] must be less than 1024 words.
- The system automatically disables [Mapping] tab in [Item address] mode.

- **User account**

If [Enhanced Security] mode is enabled, [User account] would appear in the [Source of item data] and it lists the names of users.

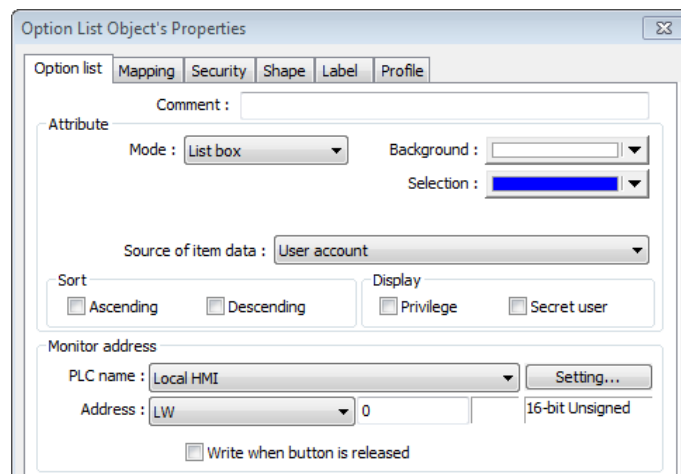

Setting	Description
Sort	Select the sorting method from [Ascending] of [Descending].
Display	If [Privilege] is selected, the privileges for each user will be displayed in option list. If [Secret user] is selected, even though it is defined to be hidden in [System parameter settings] » [Security] » [Enhanced Security], the users will still be displayed in [Option List].

Note

- The address that controls user index is [Control Address +2 (LW-n+2)] which is set in [System Parameters] » [Security] » [Enhanced Security].

Mapping Tab

This table displays all available states/items, their item data and values. To change the number of available items, please go to [Option list tab] » [Attribute] » [Item no.].

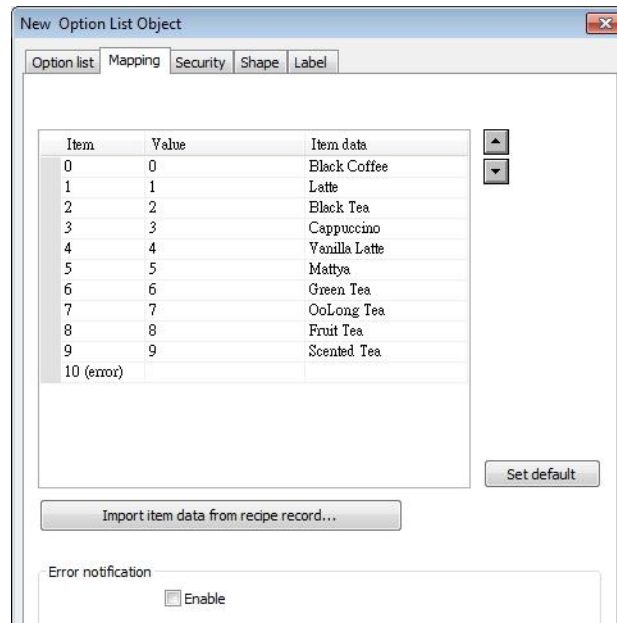

Setting	Description
Item	The system lists all available items. Each item represents a state that will be displayed in the list. This field is read-only.
Value	<p>Here user can assign value for each item, basing on the following two criteria:</p> <p>For reading: If the value in [Monitor address] is changed, the object selects the first-matched item. If no item is matched, the status goes to error state and signals the notification bit register (if requested).</p> <p>For writing: The system writes this value to [Monitor address] when user selects an item.</p>
Item data	Text displayed for each item. The Option List object displays the text of all items in the list for users to review and select.
Import item data from recipe record	This feature is enabled when select [Recipe-Selection] as [Monitor address]. Click [Import item data from recipe record] to open the [Recipe Records] setting dialog box. Select [Item data source], the data belonging to the selected column will all be imported to Option List object.

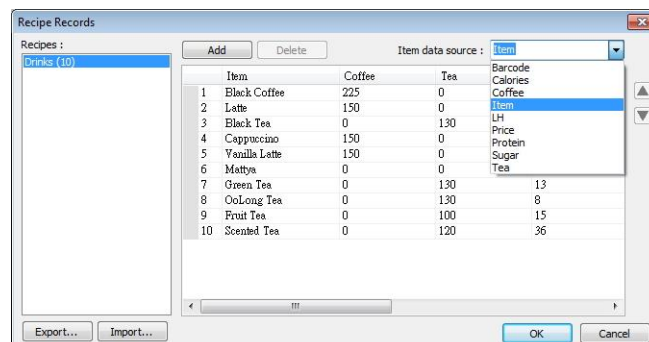

Before importing, the number of items in Option List changes

	according to the number of items defined in Recipe Records. After importing, modifying Recipe Records will not change the content of Option List.
Error state	On error state, the list box removes the highlight to represent no item is selected and the drop-down list displays the data of error state. Only the drop-down list uses error state, list box is not able to use error state. For example, item number 8 is the error state when specifying 8 in [Item no.]. (The first item number is 0)
Set default	Reset all values or states to default. That is, set 0 for item 0, 1 for item 1, and so on.
Error notification	The system will set ON/OFF to the specified bit register when error is detected. The signal of the bit register could be used to trigger a procedure for correcting the error by using objects such as Event Log, Alarm Bar, or pop-up window.

13.30. Timer

13.30.1. Overview

Timer object is a switch that can be used to control the mode to count time. The modes are explained later. Timer object uses the following 6 variables:

Timer Variable	Type	Description
Input bit (IN)	Bit	The main switch of Timer.
Measurement bit (TI)	Bit	Turns ON when the Timer begins counting time.
Output bit (Q)	Bit	Activated when the Timer finishes counting time.
Preset time (PT)	Word	Presets a time before the Timer begins counting time.
Elapsed time (ET)	Word	Displays the elapsed time.
Reset bit (R)	Bit	Resets the elapsed time (ET) to 0.

13.30.2. Configuration



Click the Timer icon on the toolbar to open the property dialog box as shown in the following figure.

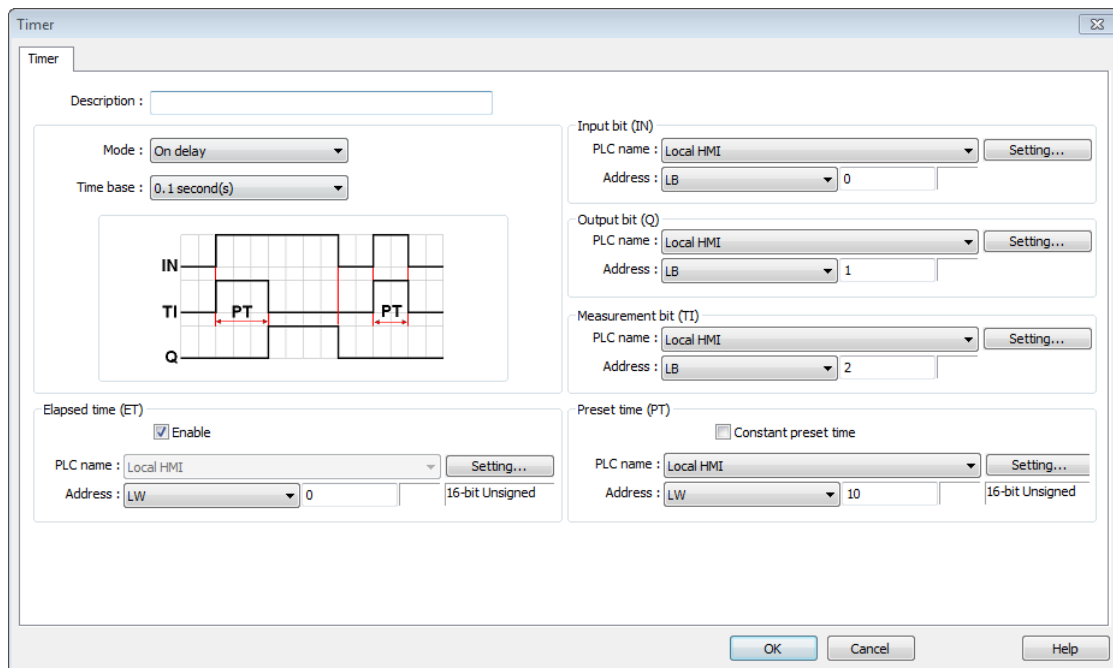

 **Note**

- [Constant preset time] is only available for cMT series.

If use cMT Series, clicking the Timer icon on the toolbar will open the Timer managing window, click [New] to configure.

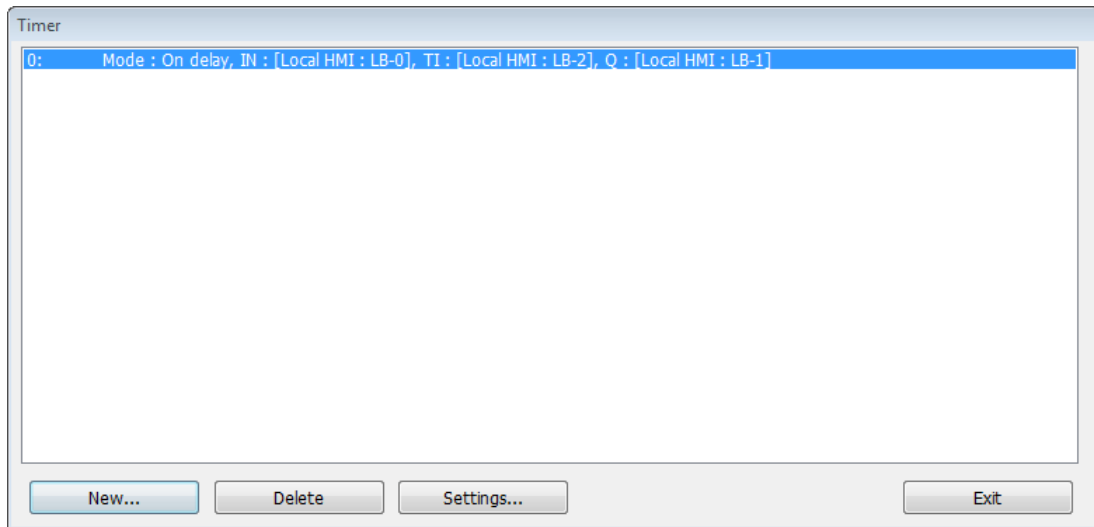

● **On delay**

Mode	Register
	<p>Input bit (IN): The main switch of Timer.</p> <p>Measurement bit (TI): Turns ON when the Timer begins counting time.</p> <p>Output bit (Q): Turns ON when the Timer finishes counting time.</p> <p>Preset time (PT): Presets a time before the Timer begins counting time.</p> <p>Elapsed time (ET): Displays the elapsed time.</p>
Description	
<p>Period 1: When the IN turns ON, TI turns ON and the ET starts counting. The Q remains OFF.</p> <p>Period 2: When the ET equals to the PT, the TI turns OFF and the Q turns ON.</p> <p>Period 3: When the IN turns OFF, the Q turns OFF and the ET is reset to 0.</p> <p>Period 4: When the IN turns ON, the TI turns ON and the ET starts counting. The Q remains OFF.</p> <p>Period 5: Turns IN OFF before the ET reaches the PT, the TI turns OFF, and the ET is reset to 0. Since the ET doesn't reach the PT, the Q remains OFF.</p>	

● Off delay

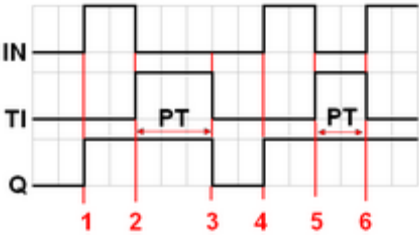
Mode	Register
 <p>The diagram shows three signals: IN (Input bit), TI (Measurement bit), and Q (Output bit) over six time periods. IN is high in periods 1, 4, and 6, and low in periods 2, 3, 5. TI is low in periods 1, 4, and 6, and high in periods 2, 3, 5. Q is high in periods 1, 4, and 6, and low in periods 2, 3, 5. Red vertical lines mark the start of each period (1-6). Red horizontal double-headed arrows labeled 'PT' indicate the duration of the high pulse for TI in periods 2 and 5.</p>	<p>Input bit (IN): The main switch of Timer.</p> <p>Measurement bit (TI): Turns ON when the Timer begins counting time.</p> <p>Output bit (Q): Turns OFF when the Timer finishes counting time.</p> <p>Preset time (PT): Presets a time before the Timer begins counting time.</p> <p>Elapsed time (ET): Displays the elapsed time.</p>
Description	
<p>Period 1: When the IN turns ON, the TI remains OFF and the Q turns ON, the ET is reset to 0.</p> <p>Period 2: When the IN turns OFF, the TI turns ON and the Q remains ON, the ET starts counting.</p> <p>Period 3: When the ET equals to the PT, the Q and TI turn OFF.</p> <p>Period 4: When the IN turns ON, the TI remains OFF and the Q turns ON, the ET is reset to 0.</p> <p>Period 5: When the IN turns OFF, the TI turns ON and the Q remains ON, the ET starts counting.</p> <p>Period 6: Turns the IN to ON before the ET reaches the PT, the TI turns OFF, the Q remains ON, and the ET is reset to 0.</p>	

● Pulse

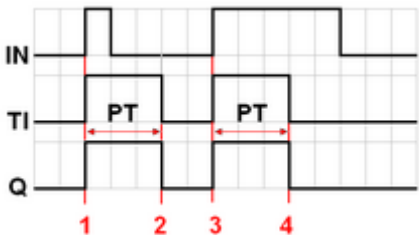
Mode	Register
 <p>The diagram shows three signals: IN (Input bit), TI (Measurement bit), and Q (Output bit) over four time periods. IN is high in periods 1 and 3, and low in periods 2 and 4. TI is high in periods 1 and 3, and low in periods 2 and 4. Q is high in periods 1 and 3, and low in periods 2 and 4. Red vertical lines mark the start of each period (1-4). Red horizontal double-headed arrows labeled 'PT' indicate the duration of the high pulse for TI in periods 1 and 3.</p>	<p>Input bit (IN): The main switch of Timer.</p> <p>Measurement bit (TI): Turns ON when the Timer begins counting time.</p> <p>Output bit (Q): Turns ON when the Timer begins counting time and turns OFF when the Timer finishes counting time.</p> <p>Preset time (PT): Presets a time before the Timer begins counting time.</p> <p>Elapsed time (ET): Displays the elapsed time.</p>
Description	
<p>Period 1: When the IN turns ON, the TI and Q turn ON simultaneously, and the ET starts counting.</p> <p>Period 2: When the ET equals to PT, the TI and Q turn OFF simultaneously. Since IN is turned OFF when counting time, the ET is reset to 0.</p> <p>Period 3: When the IN turns ON, the TI and Q turn ON simultaneously, and the ET starts counting.</p> <p>Period 4: When the ET equals the PT, the TI and Q turn OFF simultaneously.</p>	

● **Accumulated ON delay**

Mode	Register
	<p>Input bit (IN): The main switch of Timer.</p> <p>Measurement bit (TI): Turns ON when the Timer begins counting time.</p> <p>Output bit (Q): Turns ON when the Timer finishes counting time.</p> <p>Preset time (PT): Presets a time before the Timer begins counting time.</p> <p>Elapsed time (ET): Displays the elapsed time.</p> <p>Reset bit (R): Resets ET to 0</p>
Description	
<p>Period 1: When the IN turns ON, the TI turns ON and the elapsed time ET starts counting, the Q remains OFF.</p> <p>Period 2: When the IN turns OFF, if the ET doesn't reach the PT, the TI turns OFF, and at the same time the Q remains OFF. The ET is in the retentive state.</p> <p>Period 3: When the IN turns ON, the TI turns ON. The timer measurement starts again and the ET starts counting from the kept value. The Q remains OFF.</p> <p>Period 4: When the ET reaches the PT, the TI turns OFF and the Q turns ON.</p> <p>Period 5: When the IN turns OFF, the Q turns OFF. Turning ON the reset bit R will reset the ET to 0, and then the reset bit turns OFF.</p>	

● **Accumulated OFF delay**

Mode	Register
	<p>Input bit (IN): The main switch of Timer.</p> <p>Measurement bit (TI): Turns ON when the Timer begins counting time.</p> <p>Output bit (Q): Turns OFF when the Timer finishes counting time.</p> <p>Preset time (PT): Presets a time before the Timer begins counting.</p> <p>Elapsed time (ET): Displays the elapsed time.</p> <p>Reset bit (R): Resets ET to 0</p>
Description	
<p>Period 1: When the IN turns ON, the TI remains OFF and the Q turns ON.</p> <p>Period 2: When the IN turns OFF, the TI turns ON and the Q remains ON. The ET starts counting.</p> <p>Period 3: When the IN turns ON, the TI and Q remain ON, and the ET is in the retentive state.</p> <p>Period 4: When the IN turns OFF again, the ET starts counting from the kept value.</p> <p>Period 5: When the ET equals to the PT, the TI and Q turn OFF simultaneously. Turning ON the reset bit R will reset the ET to 0, and then the reset bit turns OFF.</p>	

13.31. Video In

13.31.1. Overview

The eMT, XE, and mTV Series HMI models provide the Video Input feature. By installing a surveillance camera, user can monitor the site on HMI. The video images can be stored in external devices and then analyzed on PC. This feature can be utilized in different places for monitoring, such as vehicles or buildings.

eMT, XE, and mTV Series: Support USB camera video input.

eMT, XE Series: Support IP camera video input.

eMT3120A/eMT3150A: Not only support USB camera video input but also NTSC and PAL analog video systems. For hardware, HMI provides 2 channels for Video Input. User can freely switch the channel, and capture real-time images even when Video Input is paused.

13.31.2. Configuration

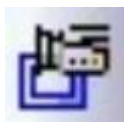

Click the Video In icon on the toolbar to open the property dialog box. Set up the properties, press OK button, and a new Video In object will be created.

General Tab

Analog Video Systems

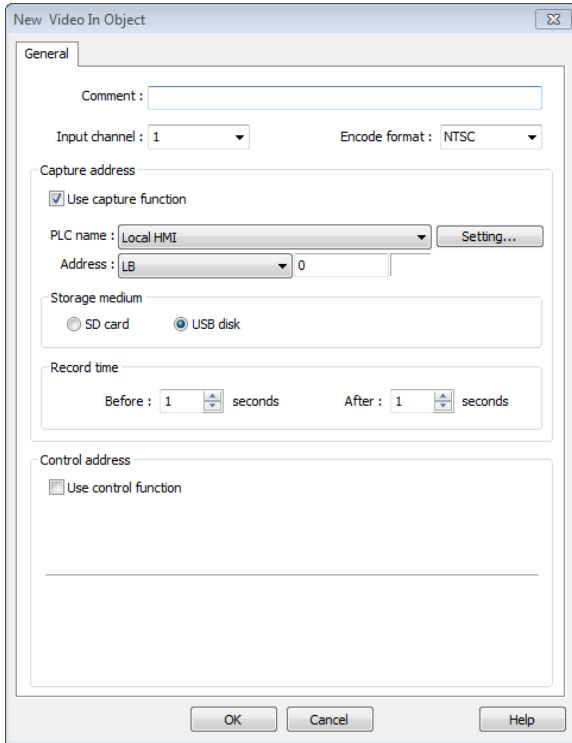

USB Camera

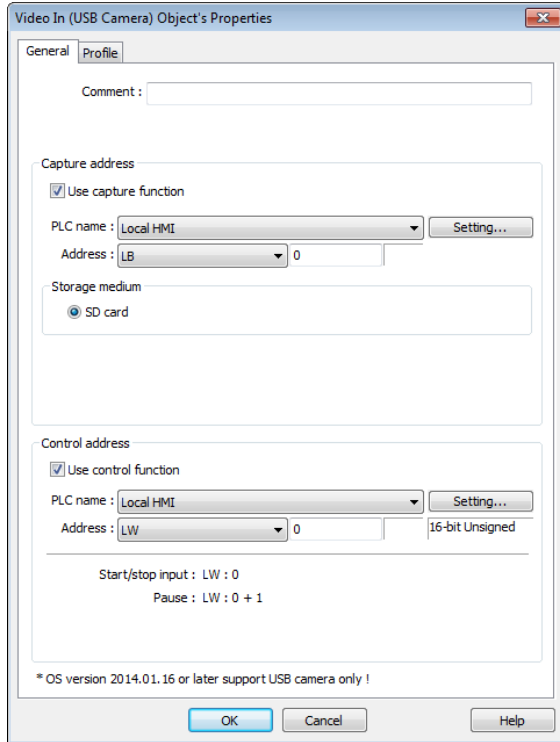

IP Camera

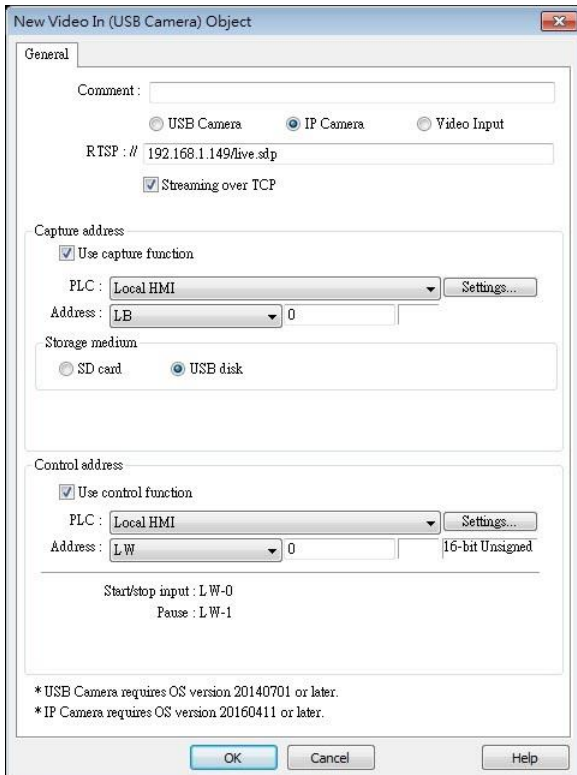

Setting	Description								
Input channel	Select the Video Input channel from channel 1 or channel 2. (Analog video systems)								
Encode format	Select the format from NTSC or PAL. (Analog video systems)								
RTSP	Enter the IP camera's RTSP address. Streaming over TCP Select this check box to stream video over TCP.								
Capture address	Select [Use capture function] check box and configure the settings. Capture address Designate the address that triggers image capturing. Storage medium Designate the storage device.								
	<table border="1"> <thead> <tr> <th>System</th> <th>Storage Device</th> </tr> </thead> <tbody> <tr> <td>Analog video system</td> <td>Select SD card or USB disk to save the captured images. The images of channel 1 will be saved in "VIP1" folder in the chosen storage and so on.</td> </tr> <tr> <td>USB Camera</td> <td>Only saves the captured images in SD card.</td> </tr> <tr> <td>IP Camera</td> <td>XE Series: Captured images can be saved in USB drive. eMT Series: Captured images can be saved in SD card.</td> </tr> </tbody> </table>	System	Storage Device	Analog video system	Select SD card or USB disk to save the captured images. The images of channel 1 will be saved in "VIP1" folder in the chosen storage and so on.	USB Camera	Only saves the captured images in SD card.	IP Camera	XE Series: Captured images can be saved in USB drive. eMT Series: Captured images can be saved in SD card.
System	Storage Device								
Analog video system	Select SD card or USB disk to save the captured images. The images of channel 1 will be saved in "VIP1" folder in the chosen storage and so on.								
USB Camera	Only saves the captured images in SD card.								
IP Camera	XE Series: Captured images can be saved in USB drive. eMT Series: Captured images can be saved in SD card.								
	Record time Set a period of time to capture the images.								
	<table border="1"> <thead> <tr> <th>System</th> <th>Method</th> </tr> </thead> <tbody> <tr> <td>Analog video system</td> <td> <ul style="list-style-type: none"> The longest period can be set from 10 seconds before triggering [Capture address] to 10 seconds after triggering. The time interval of image capturing is once every second. The captured .jpg file will be named in the following format: Before or after [Capture address] is triggered: YYYYMMDDhhmmss.jpg The moment that [Capture address] is triggered: YYYYMMDDhhmmss@.jpg </td> </tr> </tbody> </table>	System	Method	Analog video system	<ul style="list-style-type: none"> The longest period can be set from 10 seconds before triggering [Capture address] to 10 seconds after triggering. The time interval of image capturing is once every second. The captured .jpg file will be named in the following format: Before or after [Capture address] is triggered: YYYYMMDDhhmmss.jpg The moment that [Capture address] is triggered: YYYYMMDDhhmmss@.jpg 				
System	Method								
Analog video system	<ul style="list-style-type: none"> The longest period can be set from 10 seconds before triggering [Capture address] to 10 seconds after triggering. The time interval of image capturing is once every second. The captured .jpg file will be named in the following format: Before or after [Capture address] is triggered: YYYYMMDDhhmmss.jpg The moment that [Capture address] is triggered: YYYYMMDDhhmmss@.jpg 								

	For example, set [Record time] “Before” and “After” to “5” seconds. When the state of [Capture address] changes from OFF to ON, the system will start capturing one image per second, from 5 seconds before the triggering time to 5 seconds after the triggering time, which is 11 images in total including the one captured at the triggering moment.
USB Camera	Only the image of the triggering moment is captured. The name format: YYYYMMDDhhmmss.png.
IP Camera	Only the image of the triggering moment is captured. The naming format: YYYYMMDDhhmmss.png.

Control address

Use control function

If enabled, enter certain value to the control address and the following addresses can control Video Input object. For example, if the designated control address is LW-n (n is any address), enter certain value to the designated addresses will execute commands as the following table.

Address	Value	Command
LW-n	0	Stop displaying image
	1	Open channel 1 and display the image on HMI
	2	Open channel 2 and display the image on HMI
	3	Open channel 1 but don't display the image on HMI (Capture function operable)
	4	Open channel 2 but don't display the image on HMI (Capture function operable)
LW-n+1	1	Pause / resume the video
LW-n+2	1~100	Adjust the contrast ratio (Analog video systems)
LW-n+3	1~100	Adjust the brightness (Analog video systems)

- After changing the value in [Control address (LW-n)], the system will keep the new value.

- After changing the value in [Control address + 1 (LW-n+1)], the system will execute the command and then reset the value to 0.
- If [Use control function] check box is not selected, the system will play the image of the selected channel.
- If [Display adjustment] check box is selected, the contrast ratio and brightness can be adjusted. (Analog video systems)
- The USB Camera / IP Camera is controlled by LW-n (value 0 or 1) and LW-n+1.



Note

About analog video systems:

- Only one channel can be opened at a time.
- Real-time images can still be captured when Video In is paused.
- Recommended analog video systems and resolutions:

	1:1	50%
NTSC	720 x 480	360 x 240
PAL	720 x 576	360 x 288

About USB Camera:

- When the USB Camera is disconnected during video playing, video will not resume when camera is connected again. If [Control address] is used in the project, please use the control address to stop and restart video. If [Control address] is not used, switch to another screen and then return, or restart HMI in order to resume the video.
- The maximum size of Video In object of eMT3070A is 340*240, as for eMT3105P, eMT3120A, eMT3150A, XE, and mTV Series, the maximum size of Video in object is 640*480.
- When using a USB Camera, the display resolution of the run-time video is determined by the resolution supported by the USB Camera that is closest to the size of the object. The resolution supported by the USB Camera may not be identical to the size of the object. Therefore, it is good practice to adjust the size of object according to the actual resolution of the video.
- When using a USB Camera, the right and bottom edge of the Video In object will keep a distance of 50 pixels away from the window edge to prevent the run-time video from exceeding the window.
- When using a USB Camera, the background color of Video In object is black. If the resolution of the run-time video is smaller than the object, the empty area is colored black. Therefore, it is good practice to adjust the size of object according to the actual resolution of the video. The tested and available USB Cameras are: Logitech C170, Logitech C310, Logitech C910, LifeCam VX-2000.
- The OS versions that support USB Camera:

Model	OS Version (or later)
eMT3070A	20140116
eMT3105P, eMT3120A, eMT3150A	20140701
XE Series	20140624
mTV	20140807

About IP Camera:

- A RTSP address is required for using IP camera. The RTSP address can be found in the configuration tool of the IP camera, or possibly from an online repository.
- When the IP Camera is disconnected during video streaming, video will not resume when the camera is connected again. If [Control address] is used in the project, please use the control address to stop and restart video. If [Control address] is not used, switch to another screen and then return, or restart HMI in order to resume the video.
- When using an IP camera, the display resolution of the run-time video will be same as that of the object drawn in the EasyBuilder Pro project. If the actual video resolution is different from the size of the object, the resolution will be adjusted to fit the object, which may cause distortion of video image. Therefore, it is good practice to adjust the size of object according to the actual resolution of the video.
- Use the IP cameras that comply with ONVIF standard, and use RTSP for video streaming.
- To ensure the quality and smoothness of the video, and not to affect HMI's general performance, adjust the settings of IP camera when video lags or high CPU loading is observed. As the project complexity and hardware specs vary from one case to another, please fine-tune the video parameters accordingly.
- Recommended video specification:

Resolution	960x544 (max.)
Format	H.264, MJPEG
Refresh Rate	15 fps
Transmission Speed	800kbps (max.)



Click the icon to download the demo project. Please confirm your internet connection before downloading the demo project.

13.32. System Message

13.32.1. Overview

If objects use [Display confirmation request] or [local HMI supports monitor function only] is turned on/off, the corresponding messages configured here will be displayed in pop-up message boxes.

13.32.2. Configuration

Click the System Message icon  on the toolbar to open the setting dialog box.

System Message

Setting	Description
Dialog Size	Select the size for pop-up window and texts.
Confirmation required	If an object uses [Display confirmation request], this message would pop up when the object is used. [Message] shown on confirmation dialog box, and the text label of the 2 buttons, [OK] and [Cancel], can be set. Please use the same font for the labels of [Message], [OK] and [Cancel]. Additionally, only when selecting

[Label Library] for [Message], the use of Label Library for [OK] and [Cancel] buttons can be enabled.

Deny write-command	Displays when system tag LB-9196 (local HMI supports monitor function only) is turned ON.
-------------------------------	---

Allow write-command	Displays when system tag LB-9196 (local HMI supports monitor function only) is turned OFF.
--------------------------------	--

 **Note**

- cMT-SVR does not support adjusting dialog size and using system tag LB-9196.

13.33. Recipe View

13.33.1. Overview

Recipe View object can be used to display a specific recipe. All items and values of the recipe can be viewed by using this object.

13.33.2. Configuration



Click the Recipe View icon on the toolbar to open a Recipe View object property dialog box. Set up the properties, press OK button, and a new Recipe View object will be created.

General Tab

cMT Series

eMT, iE, XE, mTV Series

The name of each part of the Recipe View object is shown in the following figure.

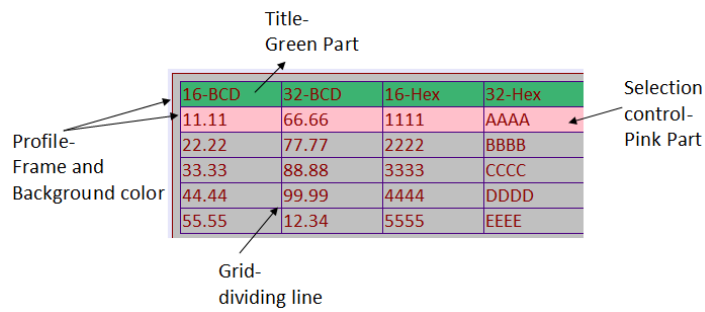

Setting	Description
Recipe table	Choose the recipe name or look for other recipes from the drop-down list.
Title	The item name assigned in [System Parameter Setting] » [Recipe]. Transparent If selected, the title row has no shading; the color selection is not available.
Profile	The frame and background color of the object can be set. Transparent Select to hide the background, the color selection is not available.
Grid (N/A for cMT)	The dividing lines between columns and rows. Enable Select to show the grid.
Selection Control (N/A for cMT)	Change the shading color of the selected row.
Default sort method	Configure how the records are sorted. [Ascending] and [Descending] can be selected.

Note

- There are 4 system registers that can be used to view/update/add/delete recipe database:

Selection

Current selection of record in Recipe View object, and it is numbered from zero. If the first record is chosen, the value of Selection will be 0. When the value of Selection is changed, the corresponding values will be updated, such as “No”, “Timer_1”, “Timer_2”, as shown in the following figure.

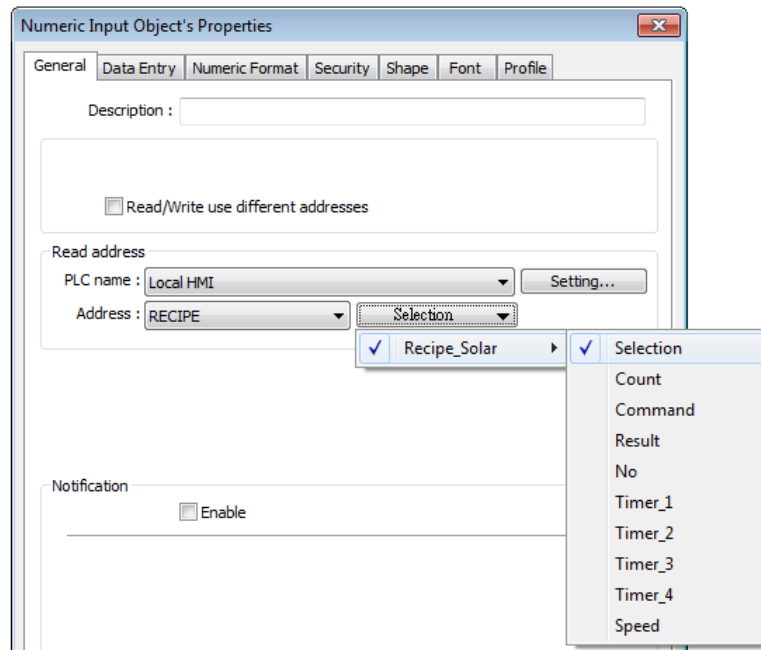

Count

Show the number of records in current recipe.

Command

Enter certain value will send command to the selected record.

Enter "1": Add a new recipe record next to the currently selected one.

Enter "2": Update the selected recipe record.

Enter "3": Delete the selected recipe record.

Enter "4": Delete all recipe records.

Result

View the result of executing commands.

Displays "1": Command successfully executed.

Displays "2": The selected record does not exist.

Displays "4": Unknown command.

Displays "8": Records reach limit (10000 records), no new records can be added.

👉 Please go to [System Parameter Settings] » [Recipes] tab to create the recipe data before using Recipe View object. See "5 System Parameter Settings".

👉 About creating recipes, see "24 Recipe Editor".

Example 1

In this example, a recipe database is created to be displayed by Recipe View object. When you select a recipe record on Recipe View object, the value of [Selection] and the corresponding values will change accordingly. When finish designing, you can modify the recipe database by entering a value in [Command].

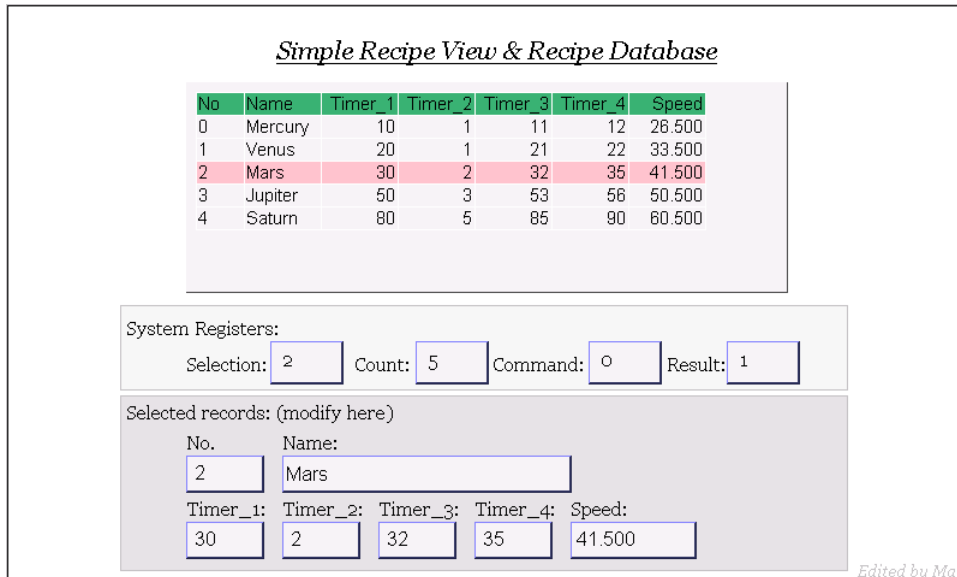

1. Create a recipe as shown in the following figure.

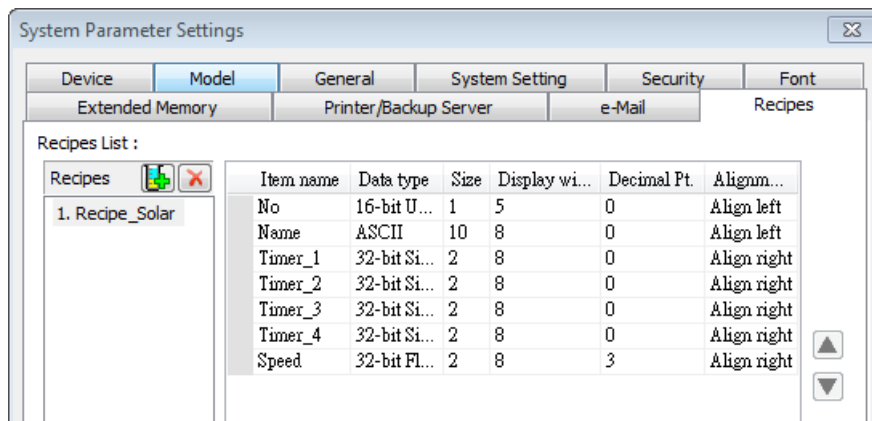

2. Use Recipe Records to create a number of records as shown in the following figure.

No	Name	Timer_1	Timer_2	Timer_3	Timer_4	Speed	
1	0	Mercury	10	1	11	12	26.5
2	1	Venus	20	1	21	22	33.5
3	2	Mars	30	2	32	35	41.5
4	3	Jupiter	50	3	53	56	50.5
5	4	Saturn	80	5	85	90	60.5

3. Create a Recipe View object and use the recipe database created in the preceding steps.
4. Create 4 Numeric objects using registers "Selection", "Count", "Command", and "Result".
5. Create corresponding input objects for "No", "Name", "Timer_1", ..., "Timer_4", "Speed". For example, "Name" is an ASCII item with size "10". Create an ASCII object and set device type to "RECIPE" » "Name".

6. The project is then completed.
7. As shown above, "Mars" is selected and the corresponding items are also updated. There are 5 records so the "Count" displays "5". Try selecting different rows of the Recipe View object. Fields "Name", "Timer_1", ...will change accordingly.
8. Try the following operations:
 - Add:
To add current data as a new record, enter "1" in "Command".
 - Update:
To update recipe database, enter "2" in "Command".
 - Delete:
To delete the selected record, enter "3" in "Command".
 - Sort the items.
 - Click the title to change the order.

Example 2

In this example, [RECIPE_Bit] can be used to read / write individual bits of Recipe data. Although BOOL type items cannot be added to Recipe Database, individual bit access of 16bit / 32bit data is possible.

As shown in the following figure, select [RECIPE_Bit] for the read address of Bit object and point to the target item, and then the available Bit selections will be displayed. In this manner, Recipe Database can be used to record, read, and write bit data.

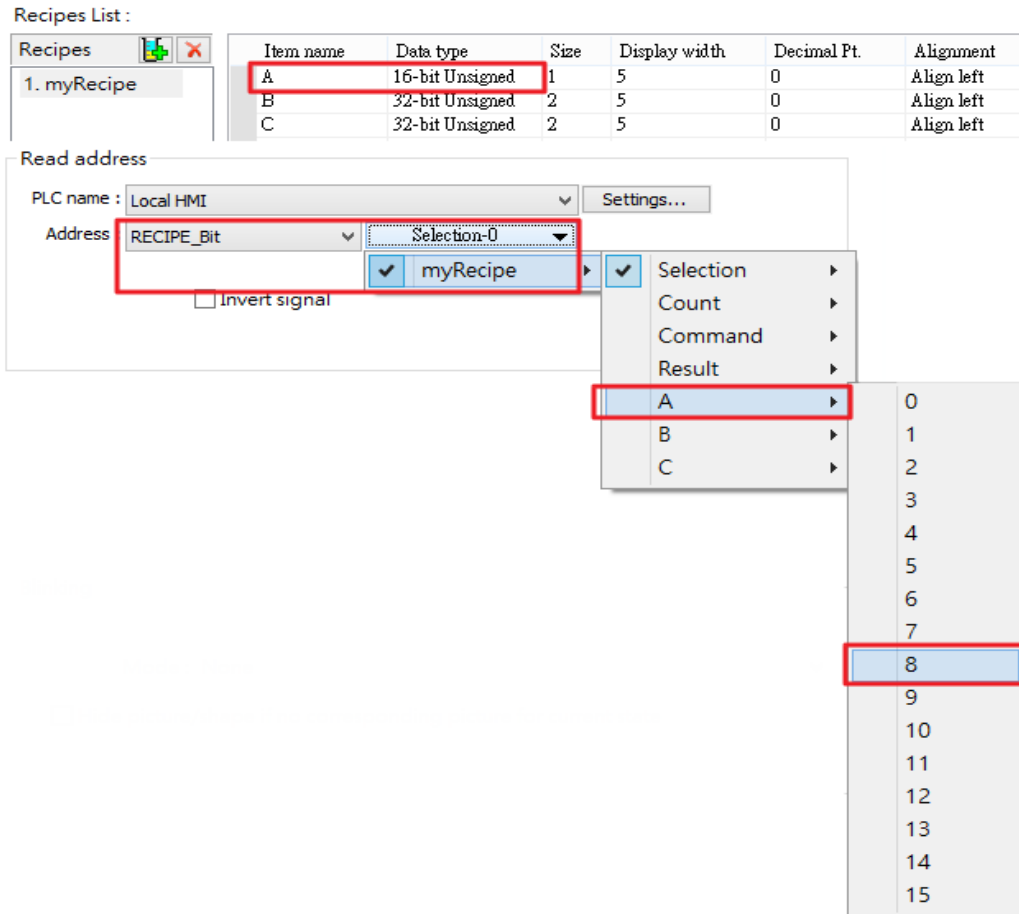

13.34. Flow Block

13.34.1. Overview

Flow Block object displays the flow status of the blocks in the pipe or the status of the transportation lines. Unlike Moving Shape object which requires a precise measurement between two points when drawing a straight line provided by users, the blocks flow at a fixed interval in a horizontal or vertical straight line.

The features of Flow Block:

- Each section of the Flow Block must be a horizontal or vertical straight line and the blocks flow at a fixed interval within it.
- Dynamic speed and direction adjustment (Speed and direction can be controlled by a designated register).
- Security mechanism (Interlock), which hides Flow Block when the status of designated bit is invalid.

13.34.2. Configuration

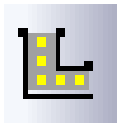

Click on the Flow Block icon on the toolbar or select [Objects] » [Flow Block] to create object.

General Tab

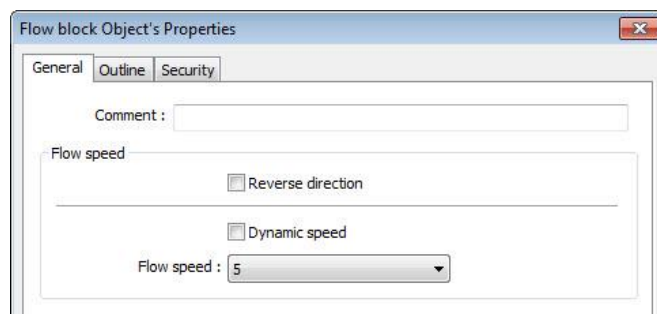

Setting	Description
Reverse direction	The blocks flow in the direction the object is drawn (the blue arrow). If select this check box, the blocks flow in the opposite direction.

Dynamic speed	<p>Read address</p> <p>The direction and speed at which the blocks flow can be controlled by a designated register. The valid range is -25 to 25. When a negative value is entered, the blocks flow in a reversed direction.</p> <p>Setting</p> <p>Displays the address and format of the designated register. [System register], [Index register], and [Tag Library] can be set here.</p>
Flow speed	<p>25 flow speed levels, the valid range is 0 to 25 when [Dynamic speed] is not selected. A larger value indicates a faster speed.</p>

Outline Tab

For setting the outline property of Flow Block. The following illustration shows each item.

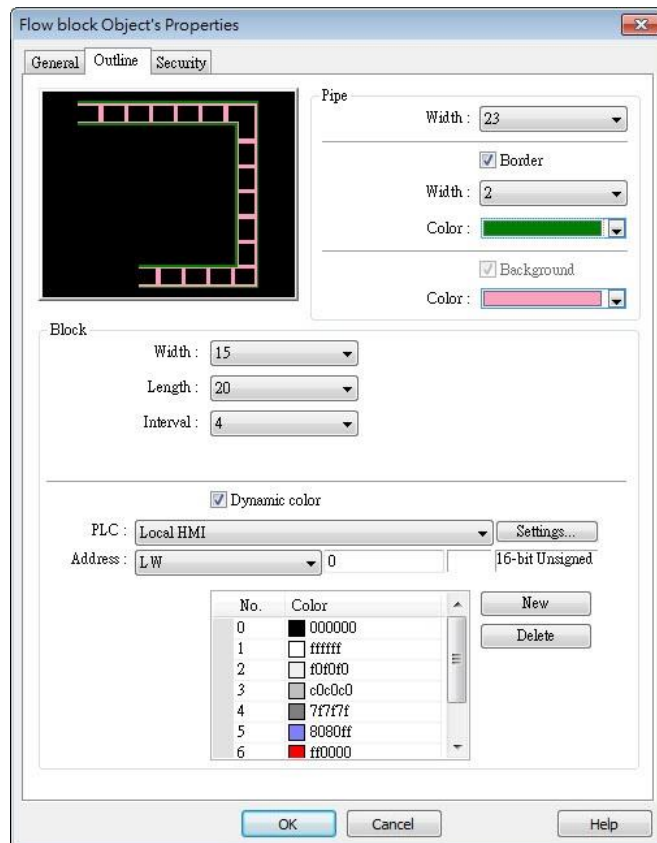
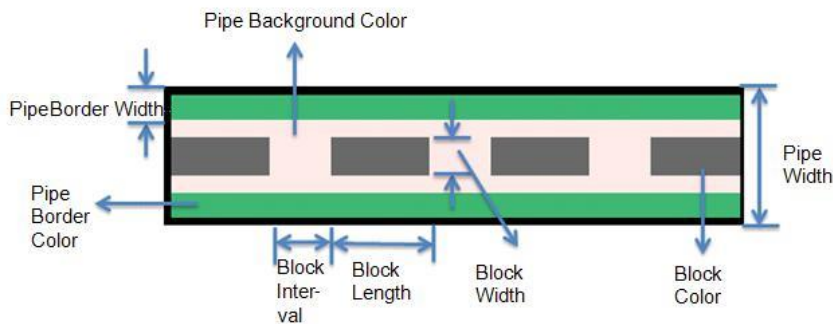

Setting	Description
Pipe	Sets the properties of the pipe within which the blocks flow. The background color, border width and color can be set. When the [Border] check box is selected, the background color must be set.
Block	Sets the properties of blocks. Width, length, interval and color can be set here.
Dynamic color	Allows dynamic color change. Nine customized colors, numbered from 0 to 8, are allowed. The color is selected by entering a value in the designated register. Entering a value greater than the largest color number changes the Flow Block to the last color in the list.

 **Note**

- If both [Reverse direction] and [Dynamic speed] check boxes are selected in [General] tab, when entering a negative value in the designated register of dynamic speed, the blocks flow in the direction the object is drawn.
- To avoid the pipe lines from overlapping when drawing a turn, there is a minimum width planned at each turn. As shown in Fig. 34.1, the sign on the cross cursor defines the minimum width. Fig. 34.2 demonstrates that each turn is drawn in the minimum width.

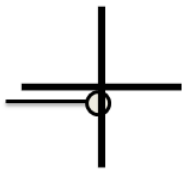

(Fig. 34.1)



(Fig. 34.2)

The valid range of the length, width, and height of the Flow Block can be adjusted according to the size of the object drawn and the size of the window.

As shown in the following figure, when the size of the Flow Block is larger, the valid range is restricted to prevent the flow block from exceeding the window size. When the size of the object is smaller, the adjustment range will be larger.

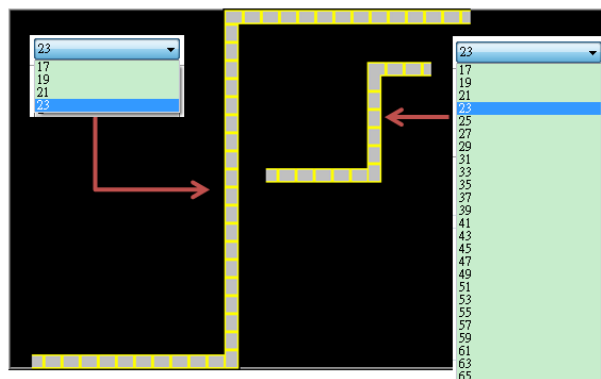

To prevent the flow block from overlapping itself, when the distance between two lines is

shorter (Section A), the valid range is restricted. When the distance is longer (Section B), the adjustment range will be larger.

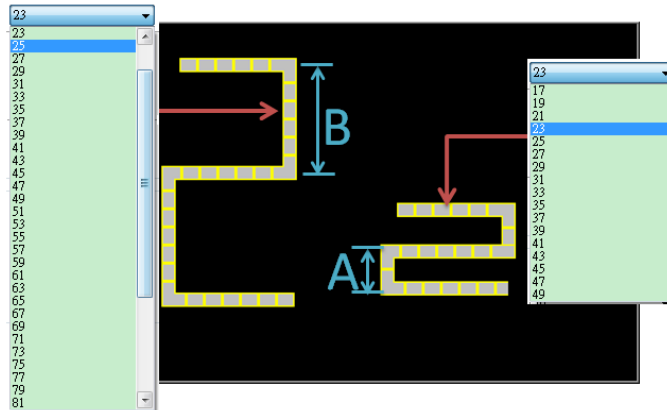

Example 1

The demonstration below shows how to use [Dynamic speed] to control the direction and speed of Flow Block by a designated word register.

1. Create a Flow Block object and select [Dynamic speed] check box. Set [Address] to LW-0, and set the format to 16-bit Signed.

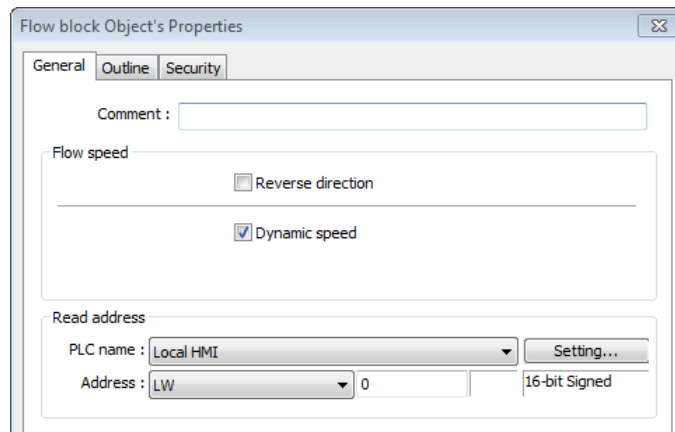

2. Create a Numeric object, set [Address] to LW-0. The high limit is 25, and the low limit is -25. The format is 16-bit Signed.

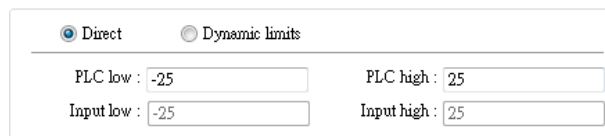

3. Execute simulation or download the project to HMI. When entering a positive value in LW-0, the blocks flow in the direction the section is drawn. A larger value indicates a faster speed. When a negative value is entered, the blocks flow in a reversed direction, and the smaller value indicates a faster speed. When 0 is entered, it stops flowing.



Click the icon to download the demo project. Please confirm your internet connection.

13.35. Operation Log

13.35.1. Operation Log Settings

13.35.1.1. Overview

Operation Log records user's operation steps and displays the record in real-time. When an error occurs, use operation log to analyze the problem. The backup tables can be used to review the process in order to resolve the errors.

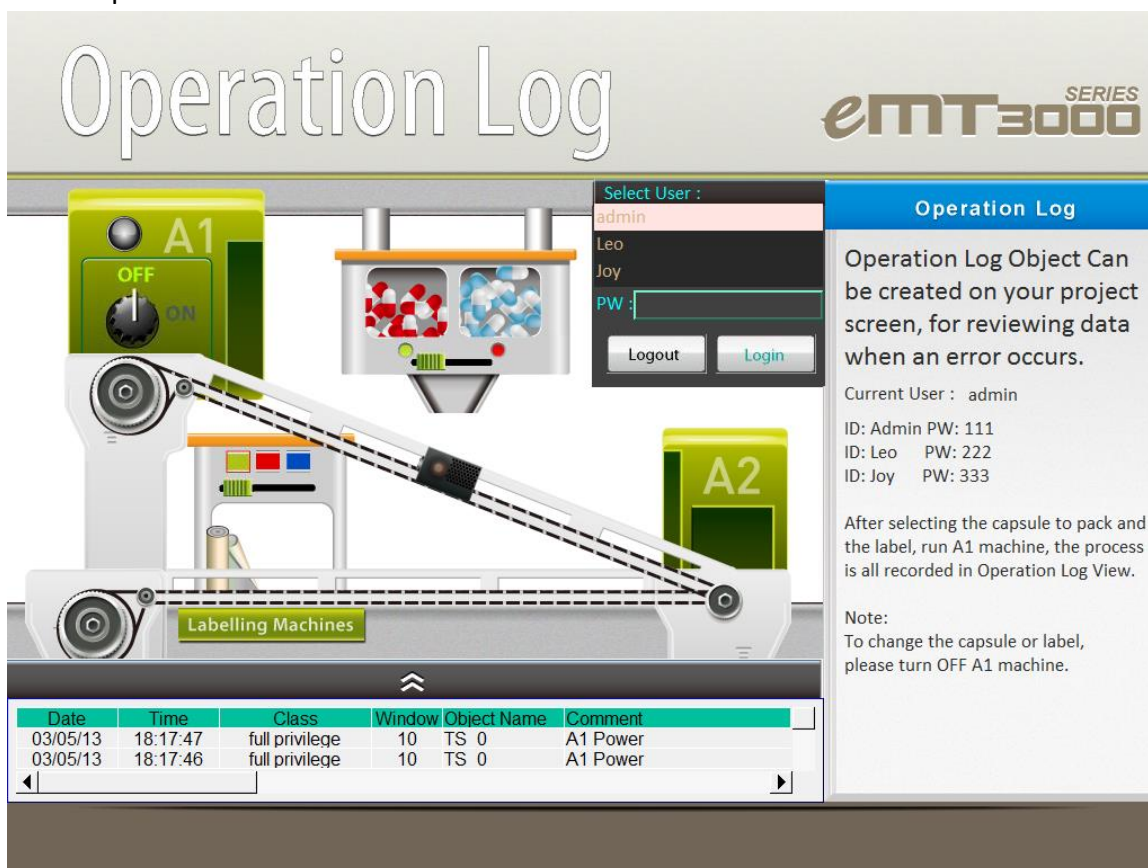

Operation Log

Operation Log Object Can be created on your project screen, for reviewing data when an error occurs.

Current User : admin

ID: Admin PW: 111
ID: Leo PW: 222
ID: Joy PW: 333

After selecting the capsule to pack and the label, run A1 machine, the process is all recorded in Operation Log View.

Note:
To change the capsule or label, please turn OFF A1 machine.

Date	Time	Class	Window	Object Name	Comment
03/05/13	18:17:47	full privilege	10	TS 0	A1 Power
03/05/13	18:17:46	full privilege	10	TS 0	A1 Power

13.35.1.2. Configuration

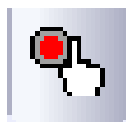

Select the objects to be recorded. Click [Objects] on the main menu, point to [Operation Log], click [Operation Log Settings], and then select [Enable operation log function] check box.

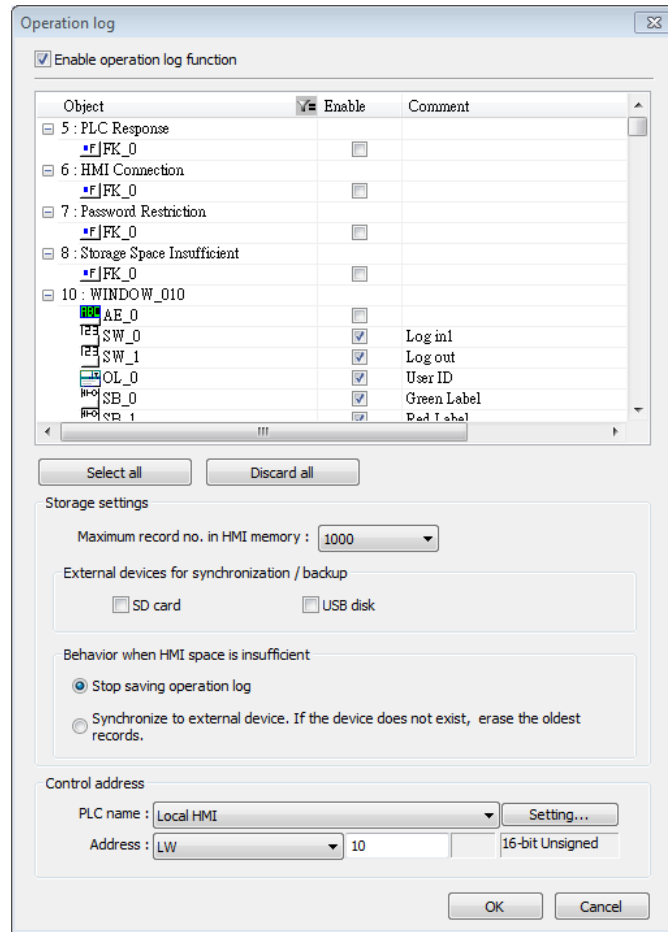

Setting	Description
Object	When Operation Log is enabled, the objects with write function are listed in the setting dialog box sorted by window numbers. [Filter]: By clicking  icon, the objects with write function are listed. Users can filter out the objects that need not to be recorded, and the log displays only the selected objects.
Enable	The selected objects are recorded by Operation Log.
Comment	The description of the object as shown in the following figure.

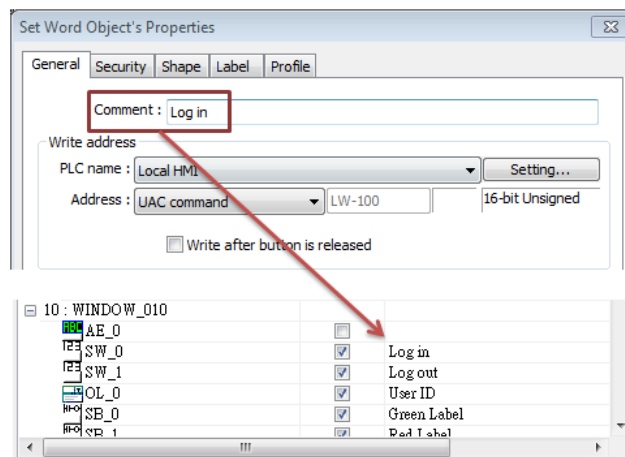

Select all	Selects all the listed objects. If [Filter] is used, clicking [Select all] only selects the objects in the list.
Discard all	Discards all the selected objects. If [Filter] is used, clicking [Discard all] only discards the objects in the list.
Storage settings	<p>Sets the way the records are stored.</p> <p>Maximum record no. in HMI memory Sets the maximum number of records that can be stored in HMI memory.</p> <p>External devices for synchronization / backup Stores backup data to SD card or USB disk.</p> <p>Behavior when HMI space is insufficient When HMI memory space is insufficient, two options are provided: [Stop saving operation log]: Stops saving new records in order to keep the earlier records. [Synchronize to external device]: Stores the Operation Log to the external device. When the device does not exist, the HMI clears the oldest records in its memory.</p>
Control address	<p>Entering different values in the control address sends corresponding commands to Operation Log and returns the result of executing the command.</p> <p>If control address is LW-n (where n is an arbitrary number), the address that returns the result of executing the command is LW-n+1.</p> <p>Control address (LW-n):</p> <ul style="list-style-type: none"> (1): Clear all records. (2): Copy the records to the USB disk. (3): Copy the records to the SD card. (4): Copy the records to the USB disk and clear the records in HMI memory. (5): Copy the records to the SD card and clear the records in HMI memory. (6): Enable Operation Log. (7): Disable Operation Log. (8): Use history data stored in USB disk after changing HMI. (9): Use history data stored in SD card after changing HMI. <p>Execution result (LW-n+1):</p> <ul style="list-style-type: none"> (0): Processing.

-
- (1): Execution succeeded.
 - (2): The device does not exist.
 - (3): The record does not exist.
 - (4): Unknown error.
-

 **Note**

- Operation Log can only record the operation of the objects that are manually triggered. Objects that cannot be manually triggered are not recorded, such as Time Based Data Transfer object.
- When running off-line or on-line simulation, Operation Log is stored under EasyBuilder installation directory: HMI_memory\operationlog\operationlog.db
- Triggering Macro with a Set Bit object generates two records, the triggering of bit and the triggering of Macro.

13.35.2. Operation Log View

13.35.2.1. Overview

Operation Log View can be used to review the Operation Log.

13.35.2.2. Configuration



Before using Operation Log View, please follow the steps described in the preceding part to finish Operation Log Settings. Click [Objects] on the main menu, point to [Operation Log], and then click [Operation Log View].

General Tab

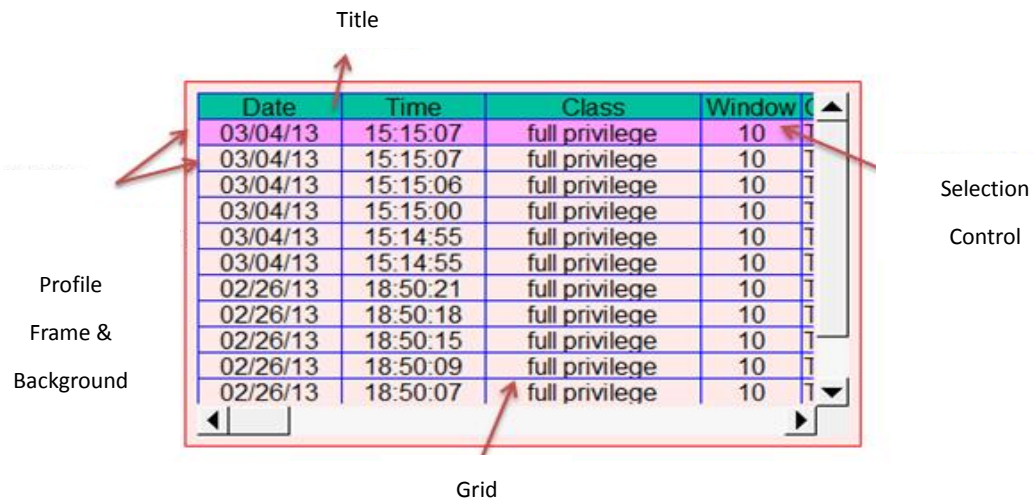
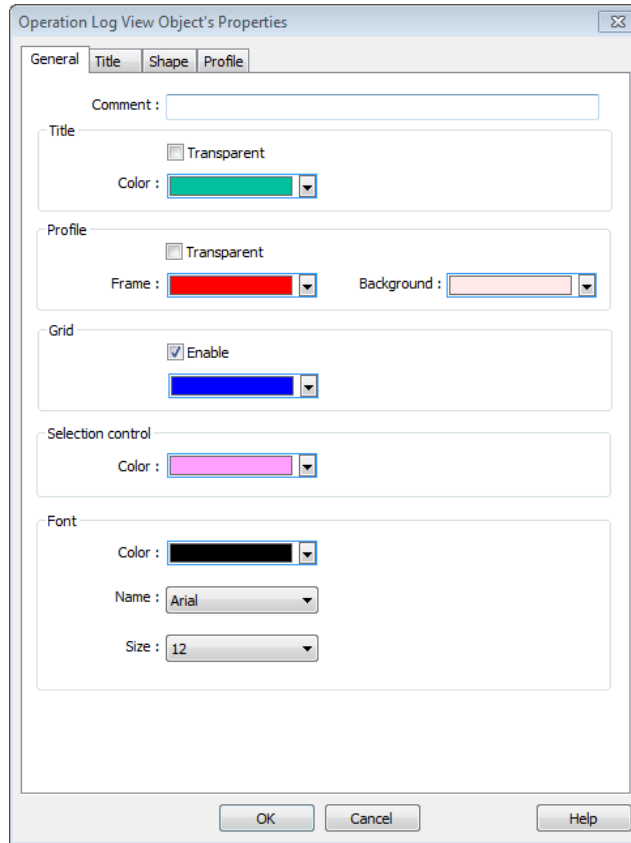

Setting	Description
Title	Sets the color of the title row. Transparent: If selected, the title row will be transparent. The color selection is not available.
Profile	Sets the color of the frame and background of the object. Transparent: Hides the frame and background. The color selection

	is not available.
Grid	Sets the color of the dividing lines between the columns and rows. Enable: If selected, displays the grid, otherwise, hides the grid.
Selection control	Sets the color of the selected row.
Font	Sets the color, font, and font size of the text displayed in Operation Log View object.

Title Tab

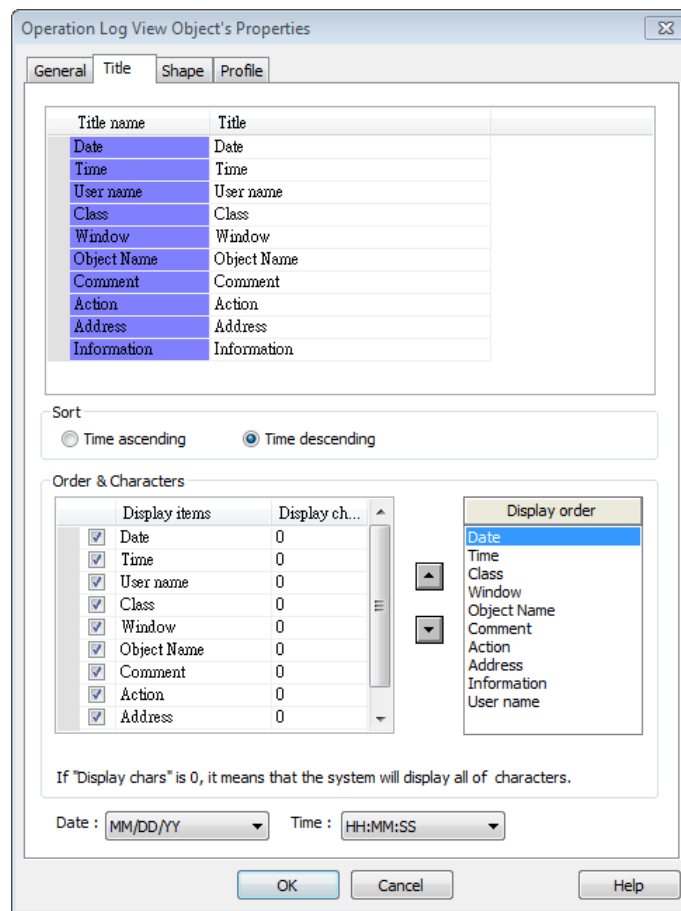

Setting	Description
Title	Sets the title displayed in Operation Log View object.
Sort	Sorts the records in time ascending or descending order.
Display order	Sets the order of the displayed item. If [Display chars.] is 0, all characters are displayed.
Date / Time	Sets the format of date and time displayed in Operation Log View object.

13.35.3. Operation Log Printing

13.35.3.1. Overview

Operation Log Printing can generate an Operation Log sheet by printing out using a printer or by saving as JPEG file into an external device. Before using this function, please go to Operation Log Settings to finish the settings.

13.35.3.2. Configuration



Select “Enable [Operation Log] printing” check box and click [Settings] button to open the Operation Log Printing dialog box.

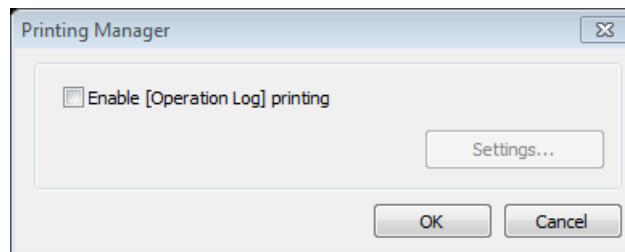

General Tab

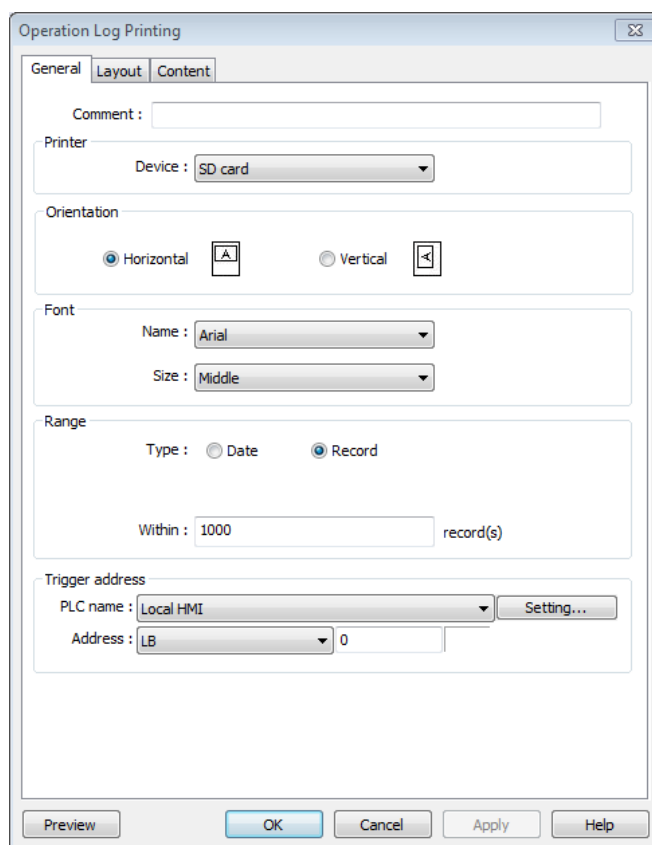

Setting	Description												
Printer	Select the device to save the Operation Log sheet. If a printer is selected, the paper size should be A4. If an external device is selected, the Operation Log sheet is saved as a JPEG file. The system generates a folder named "operationlogsheet", and the files saved in the folder are named " <i>print date_sequence number</i> ". For example, the first JPEG file saved on 2013/05/08 is named 130508_0000 and so on.												
Orientation	Sets the layout of the Operation Log sheet to be horizontal or vertical.												
Font	Sets the font and the font size to of the Operation Log sheet. The following table lists the corresponding size. <table border="1" data-bbox="496 1756 1121 1955"> <thead> <tr> <th>Size</th> <th>Title</th> <th>Content</th> </tr> </thead> <tbody> <tr> <td>Large</td> <td>20 pt.</td> <td>16 pt.</td> </tr> <tr> <td>Middle</td> <td>16 pt.</td> <td>12 pt.</td> </tr> <tr> <td>Small</td> <td>12 pt.</td> <td>8 pt.</td> </tr> </tbody> </table>	Size	Title	Content	Large	20 pt.	16 pt.	Middle	16 pt.	12 pt.	Small	12 pt.	8 pt.
Size	Title	Content											
Large	20 pt.	16 pt.											
Middle	16 pt.	12 pt.											
Small	12 pt.	8 pt.											
Range	Sets the range of the Operation Log to be included in the sheet.												

	<p>Date Sets the range by date, counted from the start day through the number of days entered. The maximum available range is 30 days.</p> <p>Record Sets the range by the number of records. The maximum available range is 10000 records.</p>
<p>Trigger address</p>	<p>Sets the register to control Operation Log Printing. When the register is set ON, it starts printing. When the printing is done, the register is set OFF automatically.</p>
<p>Preview</p>	<p>Preview the result before generating the Operation Log sheet.</p>

Layout Tab

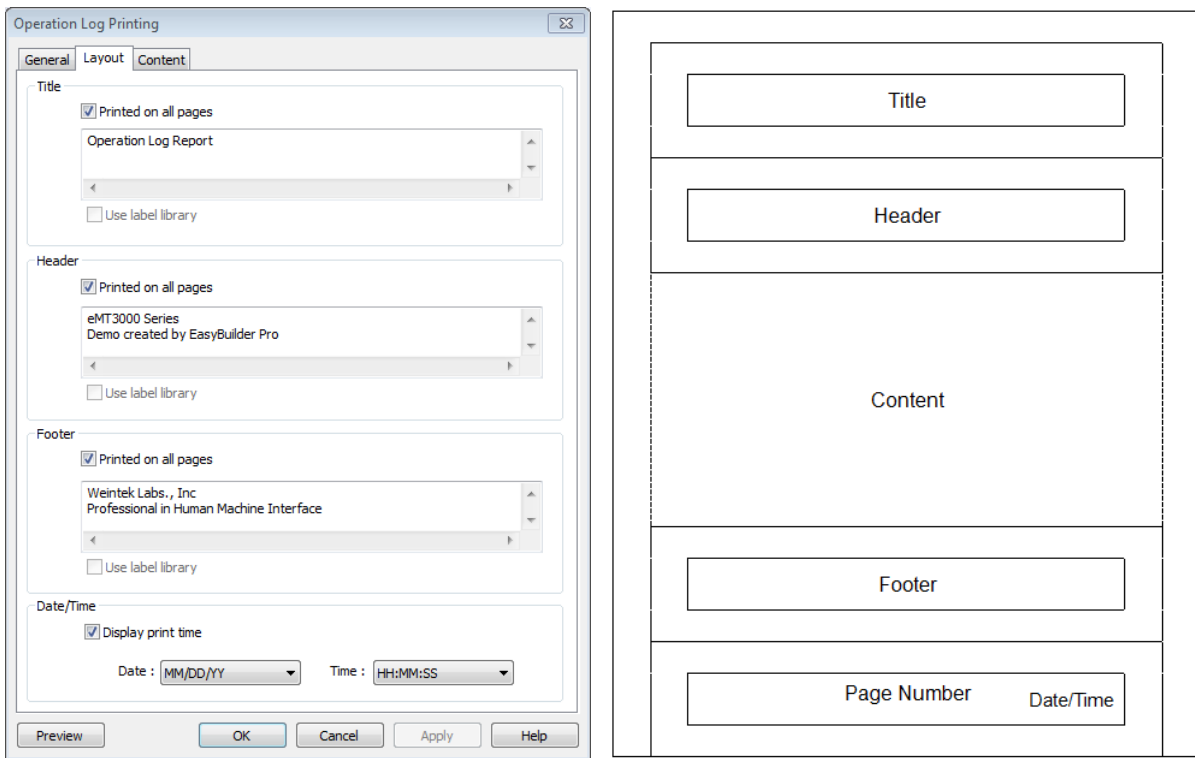

The layout of each part is shown in the above figure.

Setting	Description
<p>Title</p>	<p>Sets the content of the title. The title is limited to one line.</p> <p>Printed on all pages If selected, the title is shown on each page; otherwise, the title is shown on the first page.</p>
<p>Header</p>	<p>Sets the content of the header. The header can have 5 lines in maximum.</p> <p>Printed on all pages If selected, the header is shown on each page; otherwise, the</p>

	header is shown on the first page.
Footer	Sets the content of the footer. The footer can have 5 lines in maximum. Printed on all pages If selected, the footer is shown on each page; otherwise, the footer is shown on the last page.
Date/Time	If selected, the date/time the in the sheet is shown on the lower-right corner of each page; otherwise, the date/time is not shown.
Page number	Shown on each page.

Content Tab

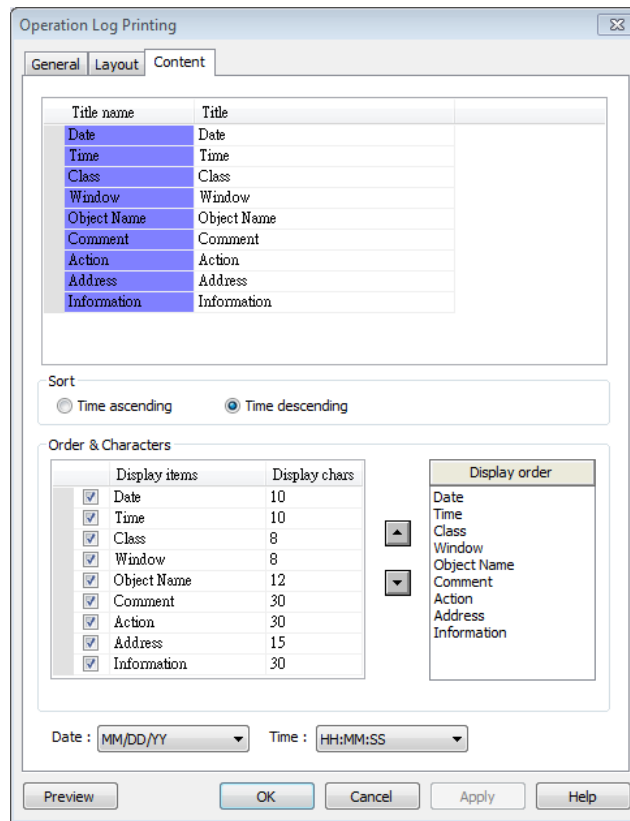

Setting	Description
Title	Sets the title displayed.
Sort	Time ascending The latest record is placed at the bottom. Time descending The latest record is placed at the top.
Date/Time	Sets the format of date and time displayed.

13.35.3.3. Demonstration

Example 1

The following demonstration explains how to create an Operation Log project.

1. Create a Toggle Switch object and a Numeric object on window number 10.
2. Go to Operation Log Settings; enable the Toggle Switch object and Numeric object on window number 10.

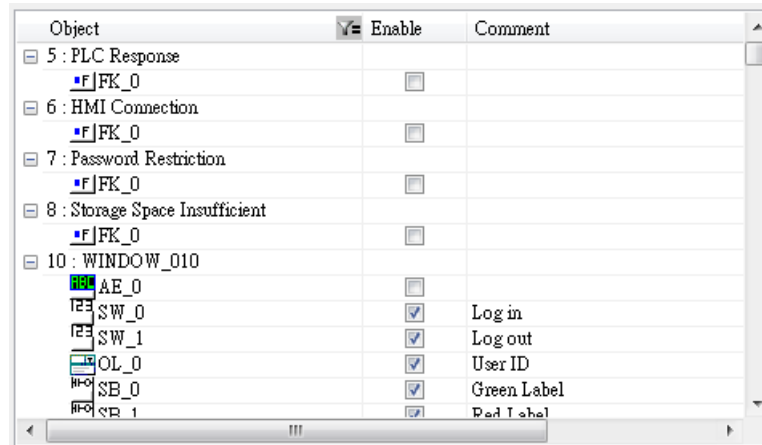

3. Create an Operation Log View object and finish relevant settings.
4. Run off-line simulation; trigger Toggle Switch and Numeric object. Operation Log is displayed by Operation Log View object.

Date	Time	Object ID	Action	Address	Information
04/05/17	13:48:22	TS 0	Toggle	Local HMI : LB-0	bit set OFF->ON
04/05/17	13:48:19	NE 0	Set word	Local HMI : LW-0	write 0->0



Click the icon to download the demo project. Please confirm your internet connection.

Example 2

Upload Operation Log to PC by using Utility Manager or use Backup object to send the file by email.

- Upload by Utility Manager
1. Open Utility Manager, click [Upload].
 2. Select [Operation log], enter file name and HMI IP, and then click [Upload].

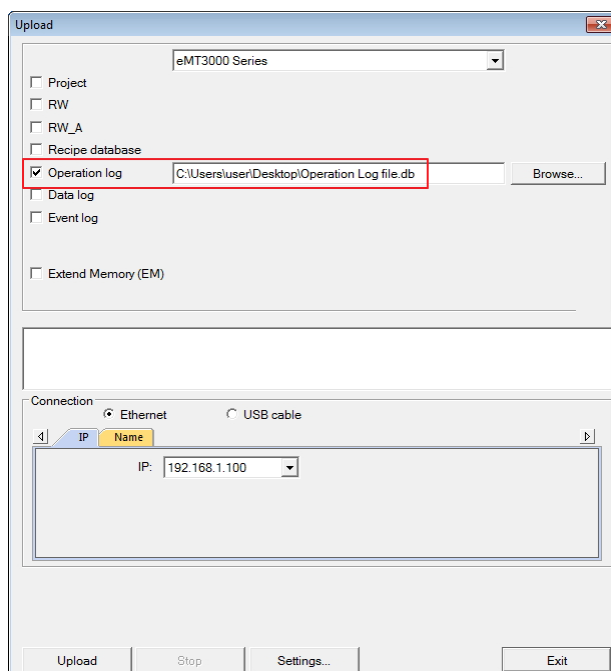

- Send the sheet by e-mail
- 1. Open [System Parameter Settings] » [e-Mail] tab. Set e-mail server and the address of recipient and sender.
- 2. Create a Backup object, under [Source] select [Operation log], and under [Backup position] select [e-Mail].

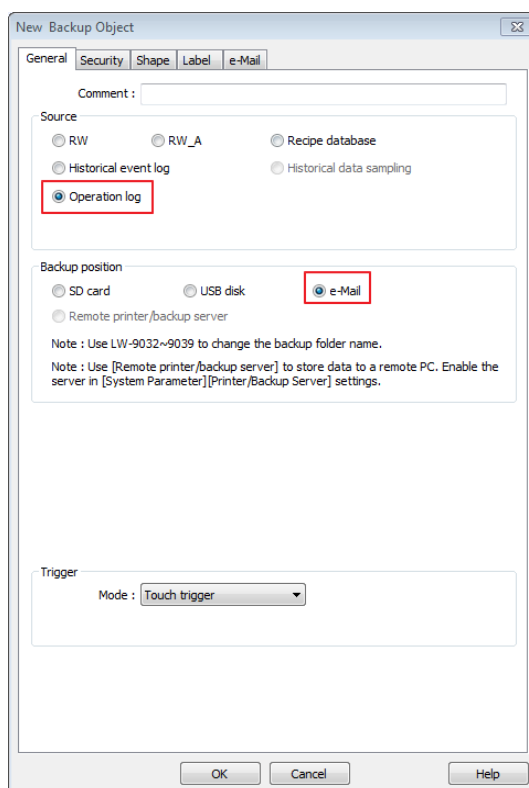

 For more information about e-Mail settings, see “5 System Parameter Settings”.

13.36. Combo Button

13.36.1. Overview

Combo Button can execute multiple commands. The former way was to overlay multiple objects in the same position, and the commands are executed in the order of the layer of the objects. This takes time to test the order when planning the project. Combo Button allows users to easily set multiple commands with one object, and freely adjust the order of executing commands.

The following are the features of Combo Button:

- Executes multiple commands.
- Allows adjusting the order of executing multiple commands.
- Displays the state in Bit or Word Lamp.

13.36.2. Configuration



Click the Combo Button icon on the toolbar to open a Combo Button object property dialog box. Set up the properties, press OK button, and a new Combo Button object will be created.

General Tab

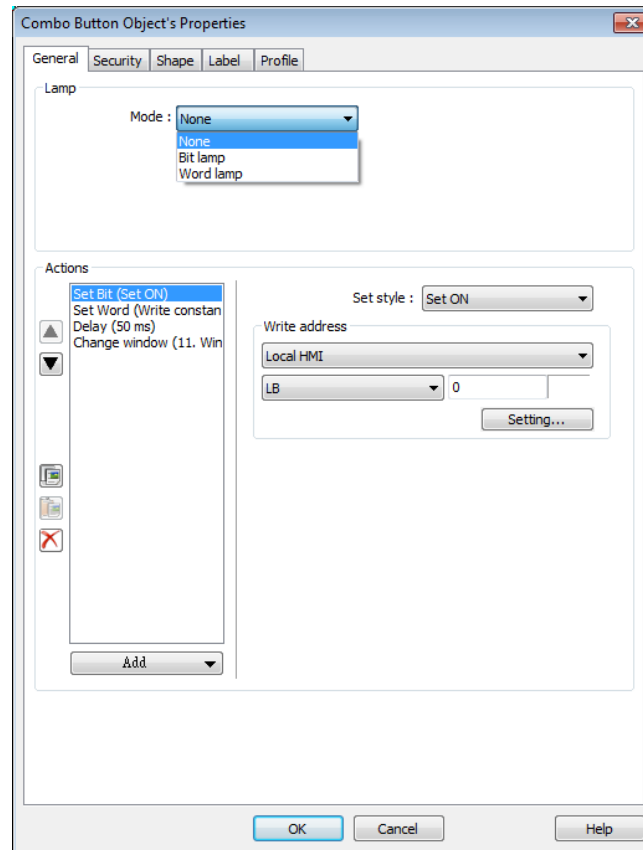

Setting	Description
Lamp	<p>The mode to display the state of a designated bit or word register.</p> <p>None: Not using lamps to show states.</p> <p>Bit Lamp</p> <p>Displays the state of a designated bit address.</p> <p>[Invert Signal] Reverses the display of ON / OFF states. For example, if [Invert signal] check box is selected, when the designated bit is OFF, the object displays ON state.</p> <p>Word Lamp</p> <p>Displays the state according to the value of a designated word register.</p> <p>[No. of state]: The number of states used by the object. The state is numbered from 0, so the number of states minus 1 will be the state number. If the value in the word register is \geq [No. of states] defined in Attribute, the highest state will be displayed.</p> <p>If the number of states is set to 8, the valid states will be 0, 1, 2, ..., 7. In this case if the word value is 8 or higher, the system will display the state 7 shape.</p>

Actions

There are four types of actions: [Delay], [Set Bit], [Set Word], and [Change window]. A combo button can execute up to 20 actions.



Change the order of the actions.



Copy, paste, or delete the selected actions.

Add**Delay**

Delays the action for a few seconds. A combo button can set one [Delay] action only.

Set Bit

Sets the designated bit ON or OFF.

Set style	Description
Set ON	Set ON the designated bit of the device.
Set OFF	Set OFF the designated bit of the device.
Toggle	Alternates the bit state each time pressed.
Momentary	Holds the bit ON only while button is pressed.

Set Word

Sets the value in the designated register.

Set style	Description
Write Constant Value	Writes a constant value to the designated register.
JOG+	Increases value in register by a set amount in [Inc. value] each time when the button is pressed, to the [Upper limit].
JOG-	Decreases value in register by a set amount in [Dec. value] each time when the button is pressed, to the [Bottom limit].
Dynamic limits	Sets the Upper / Bottom limit by a designated register. When Dynamic Address is LW-n, where n is an arbitrary number, set upper limit when using [JOG+], and bottom limit when using [JOG-].

Change Window

Switch to the designated window. A combo button can only set one [Change Window] action, and this action is always the last one executed.

13.37. Circular Trend Display

13.37.1. Overview

Circular Trend Display object draws the trend curve of Data Sampling in a polar coordinate system, where y-axis represents the radial coordinate and the x-axis represents the angular coordinate. The way to use this object is similar to using Trend Display object.

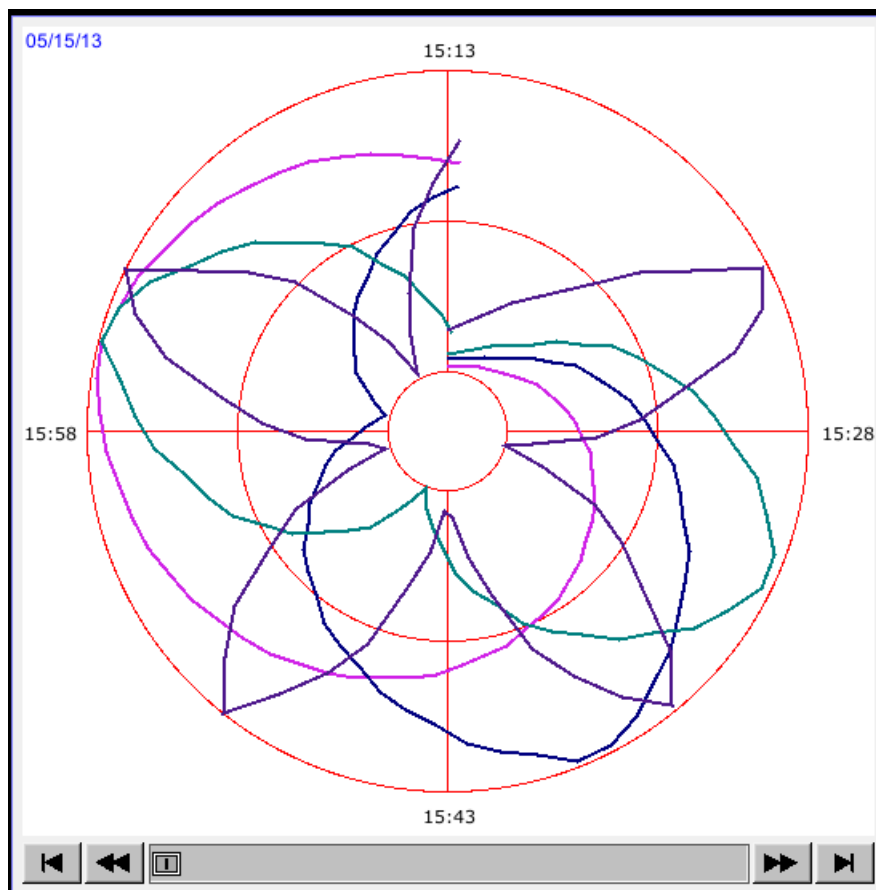

13.37.2. Configuration

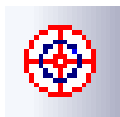

Click the Circular Trend Display icon on the toolbar to open the property dialog box. Set up the properties, press OK button, and a new Circular Trend Display object will be created.

General Tab

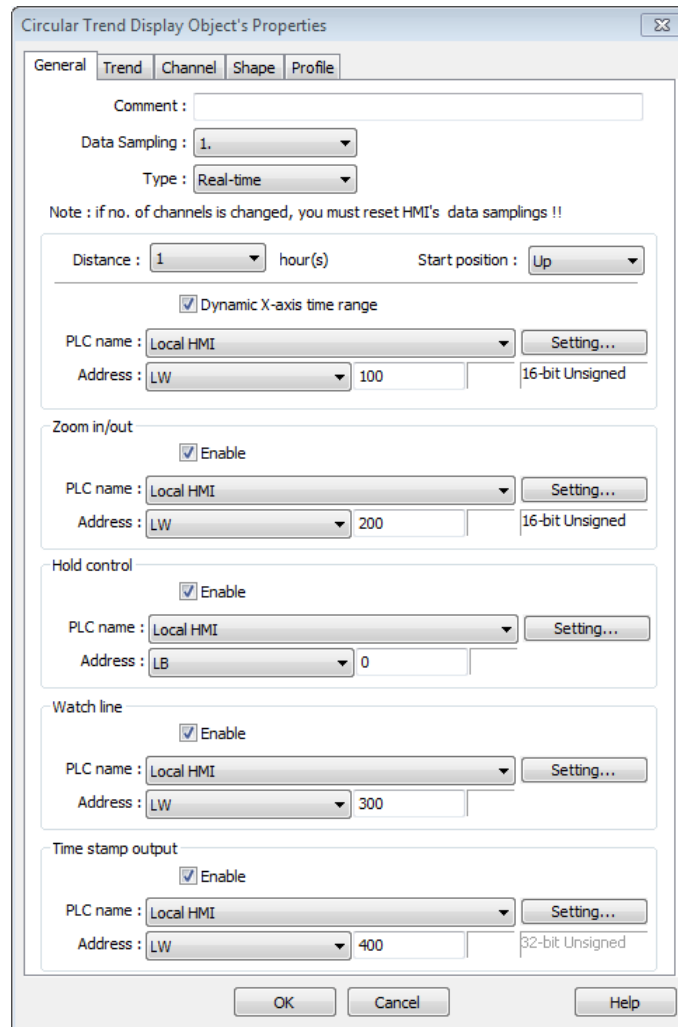

Setting	Description
Data Sampling	Selects the data source for drawing the trend curve.
Type	Selects the type of the trend from [Real-time] or [History]. Real-time In this mode, it displays a fixed number of sampling data from the moment HMI starts to present. The number of sampling data is determined by the [Max. data records (real-time mode)] setting of Data Sampling object. If the number of sampling data exceeds this number, the earlier data will not be displayed. To display earlier data or the data in other days, please select [History] mode. [Hold control] address can be used to pause refreshing the display. This only stops displaying new data in the Circular Trend Display object, and the data is still being sampled by

Data Sampling object.

History



In this mode, it displays the sampled data sorted by date. Select the data source from [Data Sampling], and then use [History control] address to view the records of different dates.

Note

If [Show scroll control] check box in Trend Tab is not selected, the earlier data cannot be viewed when exceeding the specified [Distance].
For example: Set [Distance] to 1 (hour.), then sampling data earlier than one hour is not displayed.

Refresh data automatically

If enabled, the window in which the Circular Trend Display object (in history mode) is placed will be refreshed once per second.

- The scroll controls can be used to check the refresh status.
If  button is displayed, the Circular Trend Display will be automatically refreshed.
If  button is displayed, the Circular Trend Display will stop being refreshed.
- Scrolling backward and viewing earlier data will disable [Refresh data automatically]. The button displayed is  at this moment.
- If [Refresh data automatically] is selected, the display is refreshed when change back to this window, regardless of the use of scroll controls.

Example: If [Refresh data automatically] is selected, scrolling to the earlier display stops auto-refresh. At this moment change to another window and then change back, the Circular Trend Display is still refreshed.

If [Refresh data automatically] is not enabled when building the project, to enable it directly on HMI, simply press . Please note that auto-refresh remains disabled after window change.

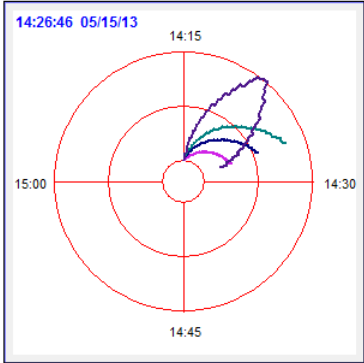
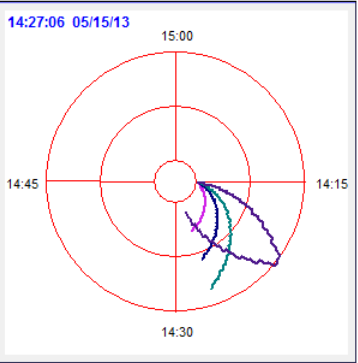
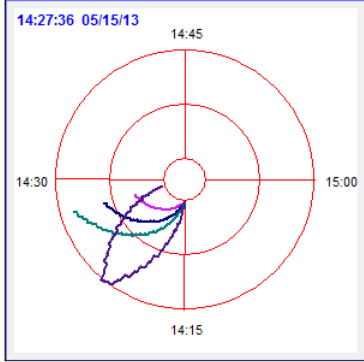
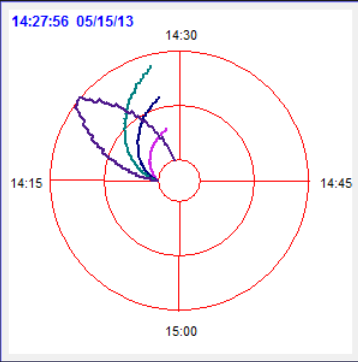
Distance	Defines the time length that the circle represents, the unit is hour, the range is 1 to 24 (hours).
Start position	The position from where to start drawing the trend curve.
(Up)	(Right)
	
(Down)	(Left)
	
Dynamic X-axis time range	If selected, a word register can be designated to control the time length of Circular Trend Display. The unit is hour. If no value is entered, the distance is set to default.
Zoom in / out	Enlarge or reduce the size of the object. The maximum size is 10 times larger. If 0 is entered in the designated register, the effect equals entering 1, the object remains the original size.
Hold control	When the register is set ON, suspend the update of Circular Trend Display. It does not stop the sampling process of Data Sampling object. This setting is available only in Real-time mode.
History control	History data is sorted by date. The system uses [History control] to select the history data that are created in different dates and then displays it by Circular Trend Display object. If the value of the designated register in [History control] is 0, the Circular Trend Display object displays the latest

record. If the value is 1, the second latest record is displayed and so on. This setting is available only in History mode.

If use with Option List object and select data source as [Dates of historical data], the history data will be sorted by date and displayed in Option List object, see “13.29 Option List”.

In the following example, when history control address is set to LW-0, and there are 4 sampling data: 20061120.dtl, 20061123.dtl, 0061127.dtl, 20061203.dtl. The corresponding data selected by the value in history control address is as the following list.

Value in LW-0	The sampling data displayed
0	20061203.dtl
1	20061127.dtl
2	20061123.dtl
3	20061120.dtl

Watch line

Displays a watch line when user touches the Circular Trend Display object, and the sampling data at the position of the watch line is output to the designated register. To display sampling data with multiple channels, the system consecutively writes the data of each channel to the designated word register and the following registers. If the data format of each channel is different, the channels are sorted by the data format of its corresponding register. In the following example, when watch address is set to LW-0, and there are 4 sampling data, the format of each data is: 16-bit Unsigned, 32-bit Unsigned, 32bit Signed, and 16-bit Signed. The corresponding watch address is as the following list.

Channel	Data Format	Data Length	Watch Address
0	16-bit Unsigned	1 Word	LW-0
1	32-bit Unsigned	2 Words	LW-1
2	32-bit Signed	2 Words	LW-3
3	16-bit Signed	1 Word	LW-5

Time stamp output

If selected, the system will start counting time from the first data sampled, and output the elapsed time counted of

the latest data sampled to the register designated in [Time stamp output + 2]. When pressing a point on the trend curve, the relative time of the nearest data sample is then output to [Time stamp output address].

Note

The format of the register designated in [Time stamp output] and [Time stamp output + 2] must be 32-bit. [Time stamp output + 2] is only available for Real-time mode while [Time stamp output] is available for Real time mode and History mode.

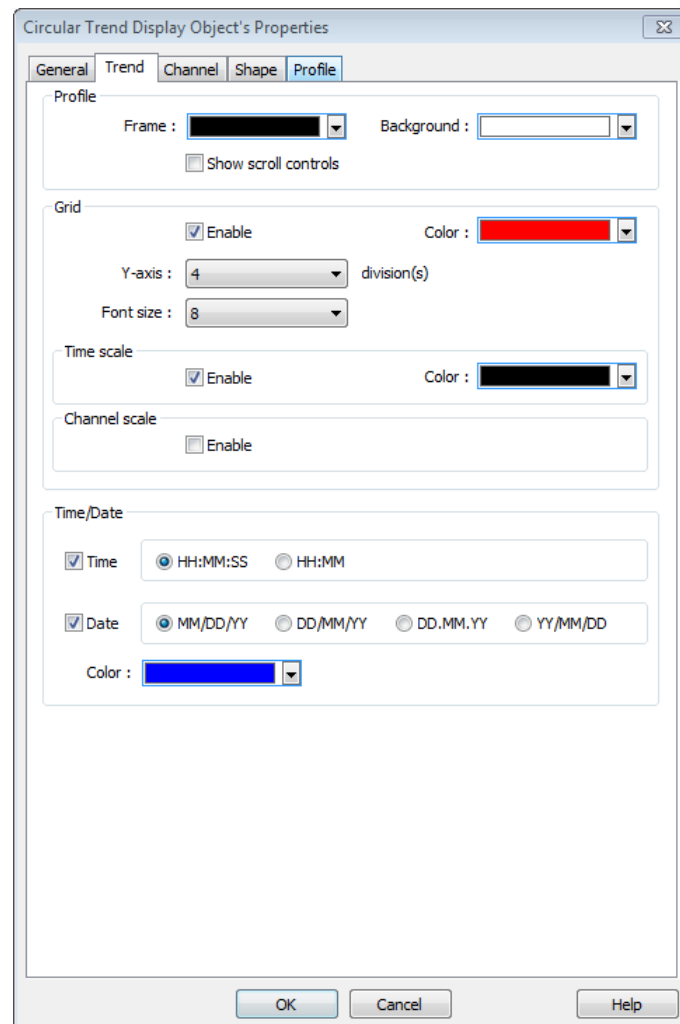
Trend Tab

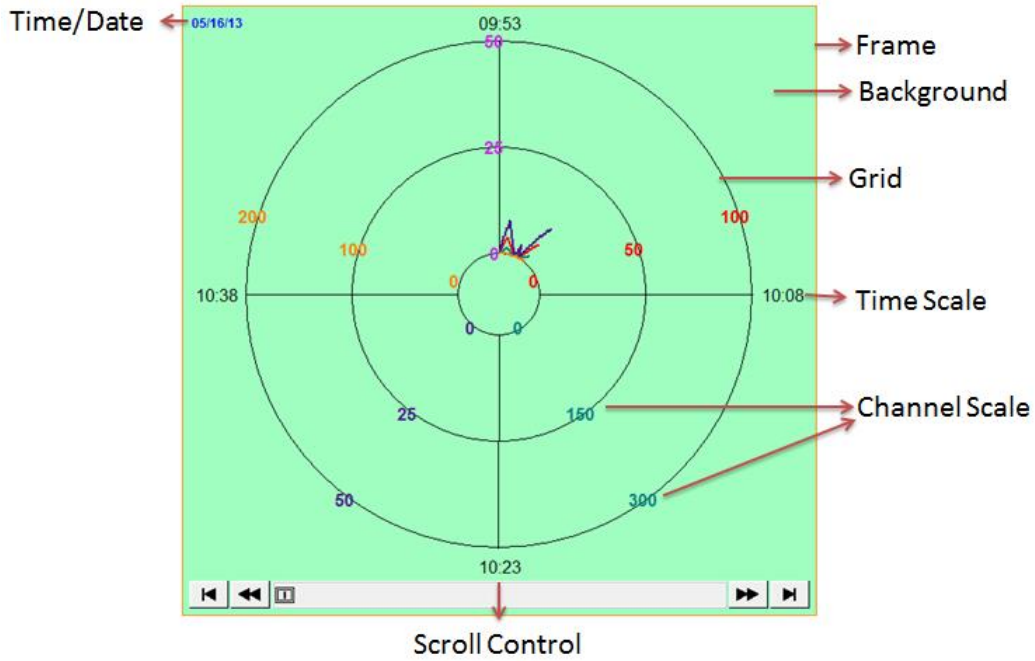

Setting	Description
Profile	<p>Frame Sets the color of the frame of the object.</p> <p>Background Sets the color of the background of the object.</p> <p>Show scroll controls The scroll controls are displayed for scrolling to view the sampling data of other time range. The minimum scrolling unit is determined by the setting of [Distance] in General tab. If [Show scroll controls] check box is not selected, the earlier data cannot be viewed when exceeding the specified [Distance]. For example: Set [Distance] to 1 (hour.), then sampling data earlier than one hour is not displayed.</p>
Grid	<p>Sets the number and the color of the dividing lines.</p> <p>Y-axis Sets the number of divisions on Y axis.</p> <p>Font size Sets the size of the font which labels the time scale or channel scale.</p> <p>Time scale If enabled, displays the time scale. When the time length is longer than 1 hour, the scale division is 1 hour. When the time length is set to 1 hour, the scale</p>

division is 15 minutes.

Channel scale

If enabled, displays the channel scale. The color of the font which labels the channel scale corresponds to the setting of the trend curve of each channel.

Time / Date

Time

Sets the display format of time.

Date

Sets the display format of date.

Channel Tab

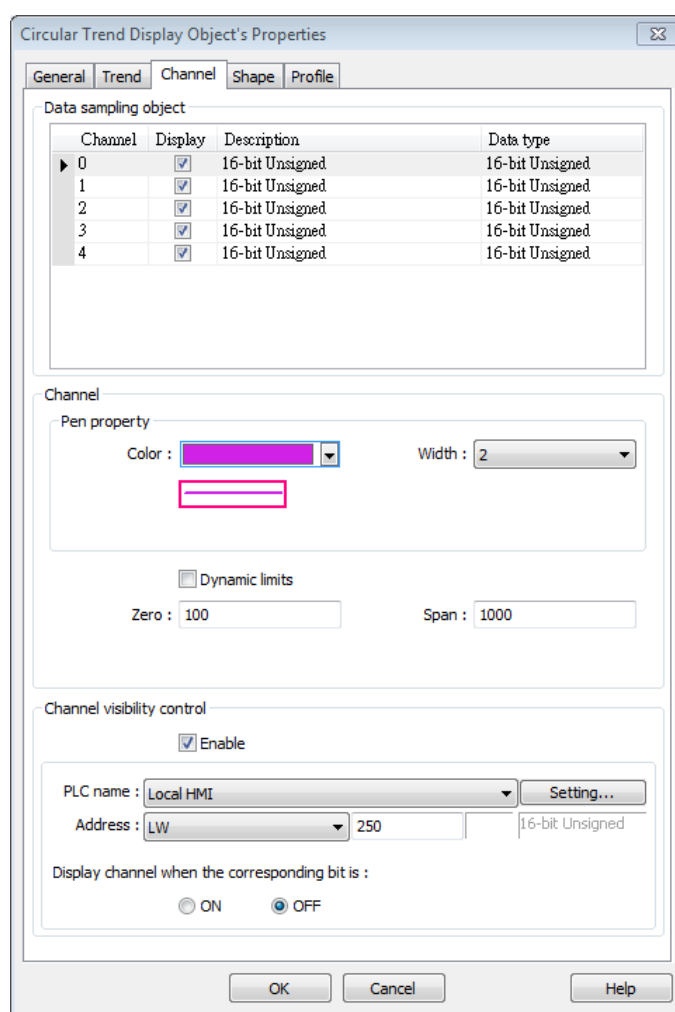

Setting

Description

Channel

Sets the style and the color of the trend curve, and the upper and lower limit of data that can be drawn on the trend curve. Up to 8 channels are supported simultaneously.

Not selecting [Dynamic limits]

The upper and lower limits of the data are set by constants.

Selecting [Dynamic limits]

The upper and lower limits are set by the designated register. When the address is LW-n, the corresponding addresses are as the following list.

Data format	16-bit	32-bit
Lower limit	LW-n	LW-n
Upper limit	LW-n+1	LW-n+2

Channel Visibility Control

If [Enable] is selected, the bits of the designated word register will be used to show/hide each channel. First bit (Bit-0) controls the first channel; second bit (Bit-1) controls the second channel, and so on.

Display channel when the corresponding bit is:

If [ON] is selected, when the corresponding bit is OFF, the channel is hidden. If [OFF] is selected, when the corresponding bit is ON, the channel is hidden.

In the following example, the control address of channel visibility is set to LW-0 and each channel shows when the corresponding bit is OFF. If there are 5 channels, the visibility of the channels is as the following list.

Channel	Control address	Bit state	Display
0	LW_bit-000	OFF	YES
1	LW_bit-001	ON	NO
2	LW_bit-002	ON	NO
3	LW_bit-003	OFF	YES
4	LW_bit-004	OFF	YES

13.38. Picture View

13.38.1. Overview

Picture View object plays slideshow of picture files saved in an external device such as a USB drive or SD card.

13.38.2. Configuration

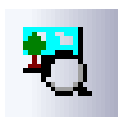

Click the Picture View icon on the toolbar to open the property dialog box. Set up the properties, press OK button, and a new Picture View object will be created.

General Tab

The screenshot shows the 'New Picture View Object' dialog box with the 'General' tab selected. The dialog has three tabs: 'General', 'Outline', and 'Security'. The 'General' tab contains the following fields and options:

- Comment:** A text input field.
- File position:** Radio buttons for 'SD card' and 'USB disk' (selected).
- Directory:**
 - Dynamic folder path
 - PLC: Local HMI (dropdown menu) with a 'Settings...' button.
 - Address: LW (dropdown menu) 0 (text input) 20 word(s) (text input).
- File selection:**
 - Automatically display the newly generated image
 - Send notification when switching to a new picture
 - Settings... LB-0 (button)
 - Specify file from address (hide toolbar)
 - PLC: Local HMI (dropdown menu) with a 'Settings...' button.
 - Address: LW (dropdown menu) 100 (text input) 20 word(s) (text input).

* Filenames must contain only ASCII characters. Unicode is not supported.

Buttons: OK, Cancel, Help

Setting	Description
Outline	<p>Sets the toolbar position, background color, and text font of the Picture View object.</p> <p>Hide delete button If selected, the delete button will not be displayed on the Picture View object toolbar. The delete button is used to delete the picture currently viewed.</p> <p>Display with original size when a picture size is smaller than the object size. If selected, when the size of the picture is smaller than the Picture View object, this setting helps to prevent distortion caused by enlarging the picture.</p>
File position	Select the file source of the picture files from [SD card] or [USB disk].
Directory	<p>The directory where the picture files are saved.</p> <p>Dynamic folder path Designate folder path by a local address.</p>
File selection	<p>Automatically display the newly generated image When a new image is generated in the folder path, Picture View object will automatically display the new image.</p> <p>Send notification when switching to a new picture When [Automatically display the newly generated image] is selected, the state of the designated address changes to On/Off when the new picture is displayed on HMI.</p> <p>Specify file from address (hide toolbar) When enabled, the displayed picture is designated by a file name in a local address, and the toolbar will be hidden.</p>



Note

- The file name must be all in ASCII characters, and the Unicode characters are not supported.
- The supported picture formats are: .jpg, .bmp, .gif, .png.

Outline Tab

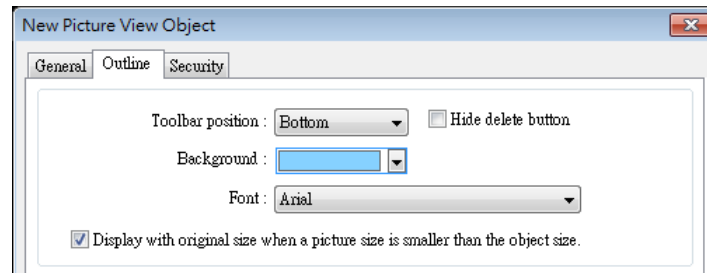

Setting	Description
Outline	Specify the position, background color, and font of Picture View object.
	Hide delete button
	When selected, the delete button for deleting the viewed picture will be hidden in the Picture view object.
	Display with original size when a picture size is smaller than the object size.
	When selected, the picture will be displayed in its original size if it is smaller than the Picture View object. This can avoid distortion caused by enlarging the picture.

13.39. File Browser

13.39.1. Overview

File Browser object can display files and folders saved in the SD card or USB disk. Apart from browsing for the files in the external devices, the name of the file and the file path selected in File Browser object can be written to the designated address.

13.39.2. Configuration



Click the File Browser icon on the toolbar, or select Tools » File Browser to open a File Browser object property dialog box and set up the properties.

General Tab

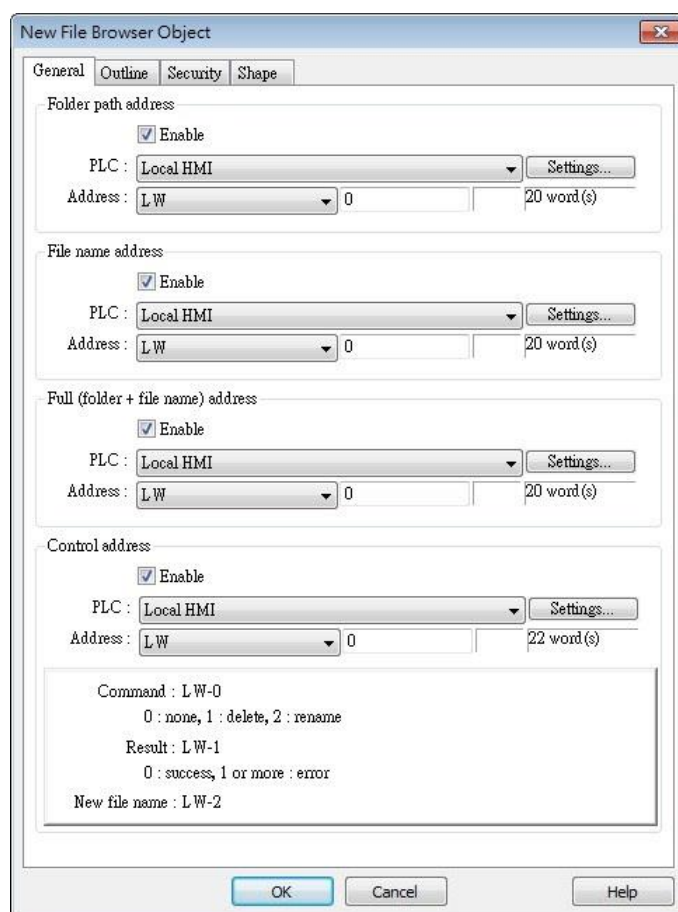

The dialog box titled "New File Browser Object" has four tabs: General, Outline, Security, and Shape. The General tab is active and contains the following settings:

- Folder path address:** Enable. PLC: Local HMI (dropdown), Settings... (button). Address: LW (dropdown), 0 (input), 20 word(s) (text).
- File name address:** Enable. PLC: Local HMI (dropdown), Settings... (button). Address: LW (dropdown), 0 (input), 20 word(s) (text).
- Full (folder + file name) address:** Enable. PLC: Local HMI (dropdown), Settings... (button). Address: LW (dropdown), 0 (input), 20 word(s) (text).
- Control address:** Enable. PLC: Local HMI (dropdown), Settings... (button). Address: LW (dropdown), 0 (input), 22 word(s) (text).

Command : LW-0
0 : none, 1 : delete, 2 : rename
Result : LW-1
0 : success, 1 or more : error
New file name : LW-2

Buttons: OK, Cancel, Help

Setting	Description
Folder path address	Current directory.
File name address	The file name of the currently selected file.
Full (folder + file name) address	The full directory and file name of the currently selected file.
Control address	Designate the control address used for deleting a file or changing file name in File Browser. Command: Control Address 0: None 1: Delete 2: Rename Result: Control Address+1 0: Success 1 or more: Error New File Name: Control Address +2

Outline Tab

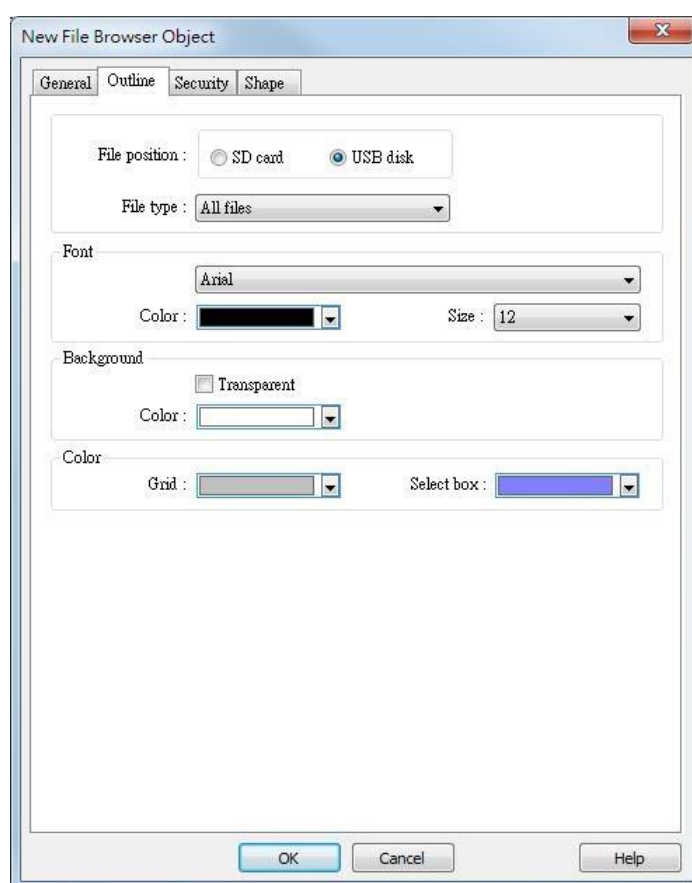

Setting	Description
Folder position	Select the position of the file from SD card or USB disk.
File type	Select all files or only CSV file to be displayed.
Font / Background / Color	Set the attributes and font of the object.



Note

- The file name and the directory of the selected file will be written to the designated address, but changing the contents of the designated address will not change the selected file in the File Browser.
- The system will read the folder path address and file name address when the HMI is restarted or when an external device is inserted to the unit. If valid data is can be read from the designated address, the system will then automatically navigate to the appropriate directory and highlight the file according to the data read. If [Folder path address] is not enabled, the data at Full (folder + file name) address will be read.

13.40. Import/Export

13.40.1. Overview

With Import/Export object, Recipe Database or String Table can be imported or exported.

13.40.2. Configuration

Click the Import/Export icon on the toolbar to open the Import/Export Object management dialog box. To add an Import/Export object, click [New], set up the properties, press OK button and a new Import/Export object will be created.

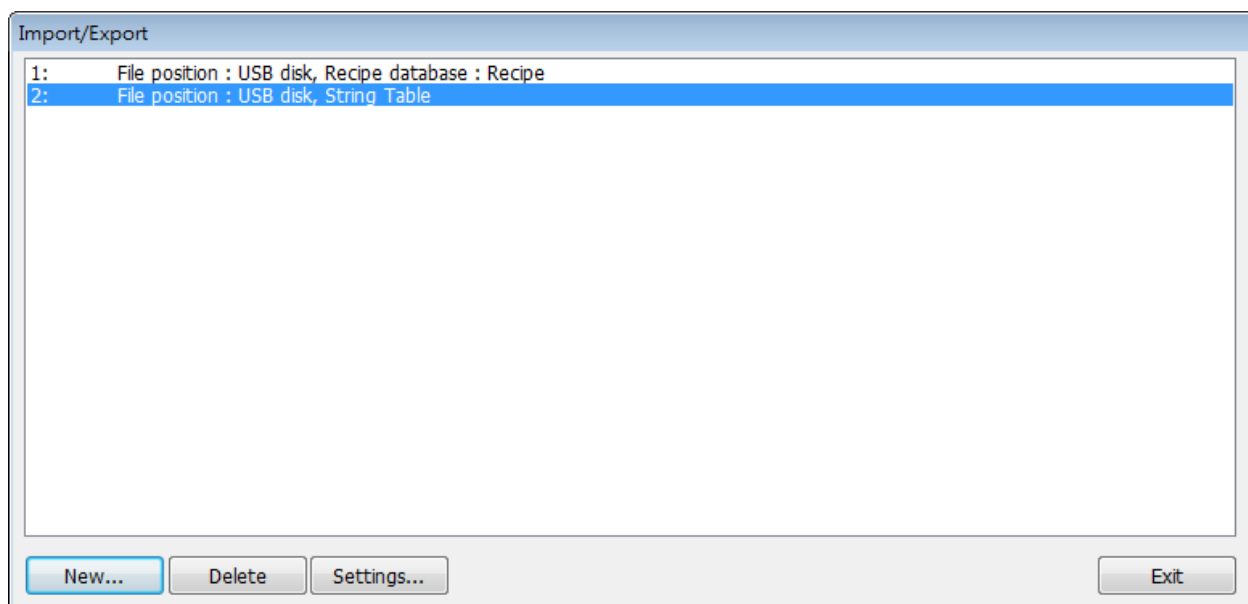

General Tab

Setting	Description
Type	Select the file source from Recipe Database or String Table.
File position	Select the position of the file to be imported / exported from SD card, USB disk, or Remote HMI (cMT Series). When Remote HMI is selected, please note that only files in cMT Series models can be imported.
Recipe	Select the recipe. This option is hidden when select String Table.
Control address	Designate the control address used for performing import/export, or displaying the result. Control: Control Address Recipe Database: 0: None 1: Import 2: Export (no overwrite)

	3: Export String Table: 0: None 1: Delete 2: Import 4: Export (no overwrite) 5: Export Status: Control Address+1 0: Idle 1: Busy Result: Control Address +2 1: Success 4: The file already exists, no overwriting. Other: Error
File name address	The name of the imported/exported file. If [Include folder path] is selected, the full directory and file name will be included at this address.
Folder path address	The directory of the imported/exported file.
Remote HMI address	When the file position is [Remote HMI (cMT Series)], please enter the remote HMI's IP address in this field.

Example 1

The following is an example on recipe export/import settings.

Field	Setting
File position	USB disk
Recipe	Recipe_A (or other recipe)
Control address	LW-100
File name address	LW-200
Folder path address	LW-250

1. Create two ASCII Input objects. Set address to LW-200 and LW-250 respectively.
2. Enter the file name in LW-200: 2015_recipe.csv.
3. Enter the folder path in LW-250: Setting.
4. Use a Set Word object to write value 3 to LW-100. Then, Recipe_A will be exported to the USB disk, in the "Setting/2015_recipe.csv" file.

 **Note**

- When performing “Export (no overwrite)” command, if the target file already exists, the export operation will be canceled, and the result value will be set to “4”.

The following lists the result values and the information.

Result (HEX)	Information
0x1	Success.
0x4	File already existed and will not overwrite.
0x100	Data contains non-numeric data.
0x101	Path contains invalid string “.”.
0x102	Communication error while updating Recipe DB.
0x103	Error while reading Recipe DB information from project file.
0x200	General exception.
0x201	General status error.
0x202	Import to unknown database type.
0x203	Error while validating Recipe DB table definition.
0x204	Error while validating Recipe DB table data.
0x205	Error while writing Recipe DB table definition.
0x206	Error while writing Recipe DB table data.
0x300	File error: Unknown error.
0x301	File error: Empty file name.
0x302	File error: The external device does not exist.
0x303	File error: Invalid file name (directory or special files), or a folder with the same name already exists.
0x304	File error: Unable to remove file.
0x305	File error: Open file stream error.
0x306	File error: Unhandled BOM.
0x307	File error: Error while parsing CSV file (incorrect formats).
0x308	File error: Insufficient space on the external device.
0x400	Database general exception.
0x401	Database error: Unable to open table.
0x402	Database error: Unable to get rows.
0x403	Number of columns in CSV file and in Recipe DB do not match.

13.41. Pie Chart

13.41.1. Overview

The Pie Chart object draws a pie chart that is divided into slices to illustrate numerical proportion, according to the value of the designated read address.

13.41.2. Configuration



Click the Pie Chart icon on the toolbar to open the property dialog box. Set up the properties, press OK button, and a new Pie Chart object will be created.

General Tab

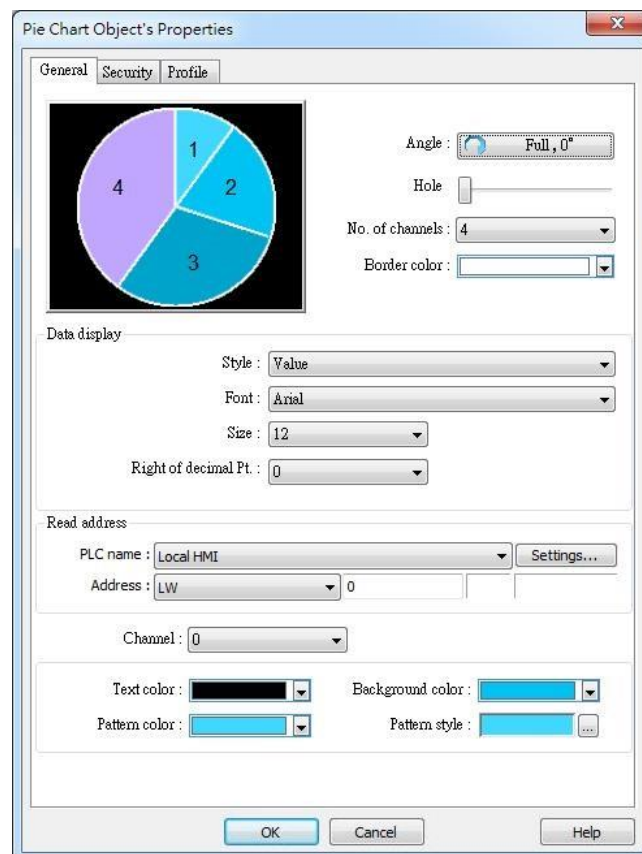

Setting	Description
Angle	Set the [Start degree] of the chart. Choose the Chart to be [Clockwise] or [Counter clockwise]. If [Full circle] isn't selected, then [End degree] must

be set.

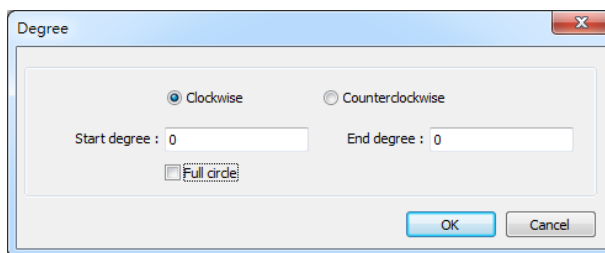

Hole

Set the size of the hollow circle in the center of Pie Chart.



No. of channels

Set the number of channels to be displayed in the chart. The range is from 2 to 16.

Border color

Set the color of the border.

Data display

The [Style] can be set as [None], [Value] and [Percentage]. The [Font] and [Size] are for the text on the chart. For Value Style, the [Right of decimal Pt.] can set the value on the chart to be displayed with the decimal point. The [Right of decimal Pt.] option is only available for [Value] style.

Read Address

The address is for channel 1. The following consecutive addresses are for the rest of the channels. For example, if the Read Address is LW-0, then the Read Address for channel 2 is LW-1; channel 3 is LW-2...and so on.

Channel

Set the [Text color], [Background color], [Pattern color], and [Pattern style] of the selected channel. The [Background color] is for the [Pattern style] that has background. If the [Pattern style] doesn't have a background, then the [Background color] doesn't need to be set.

13.41.3. Combo Setting

cMT Series HMI support combo setting for Pic Chart, which allows setting of multiple related objects at a time. Pic chart can be set with Background and Legend.

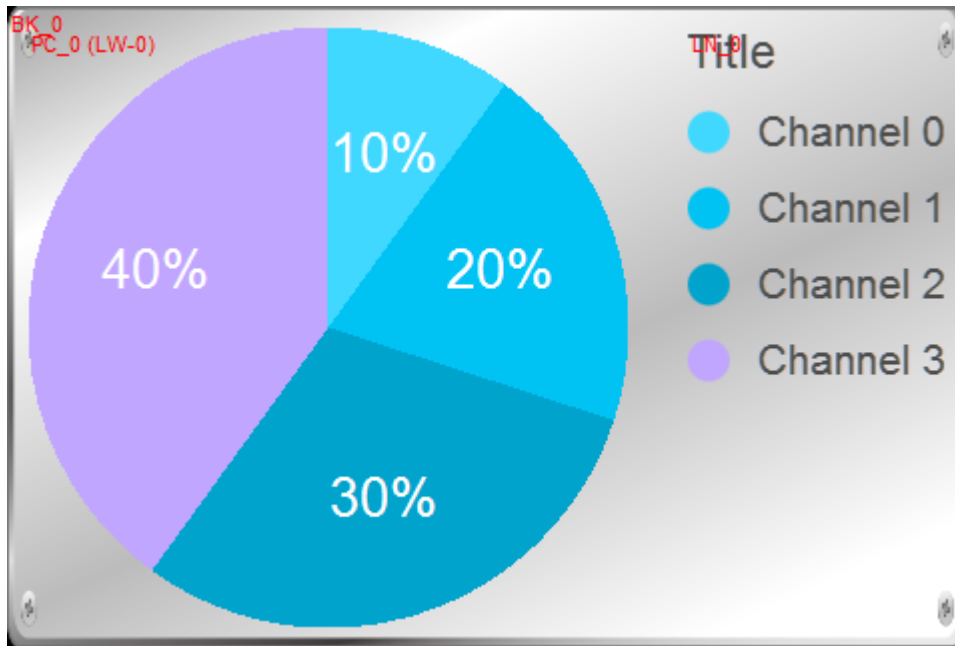

Background

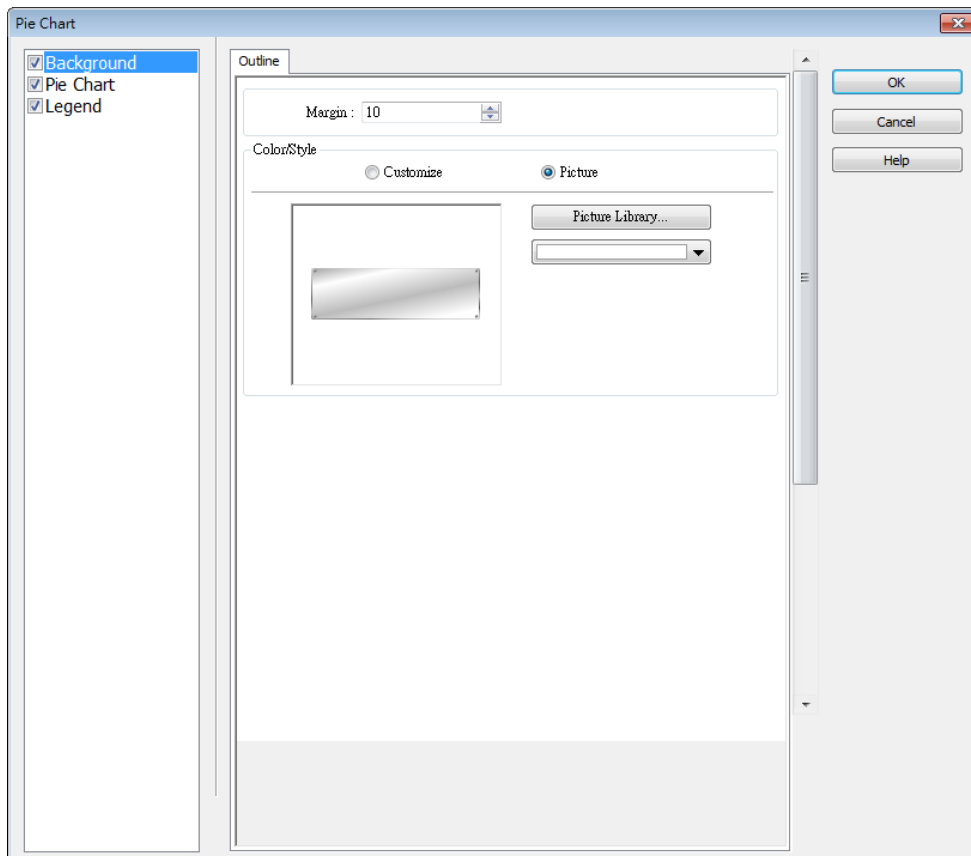

Setting	Description
Margin	Specify the space between the background edge and the objects.
Color/Style	Customize

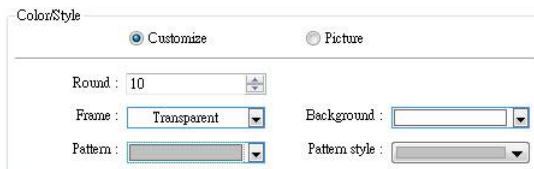

Select a suitable background pattern and color.

Picture

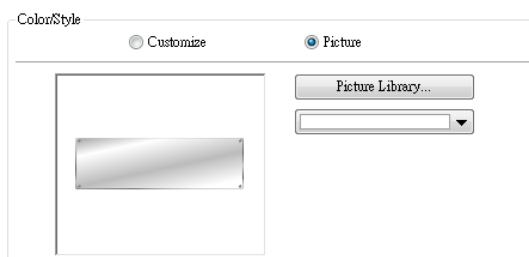

Use the default picture or choose a picture from Picture Library.

Legend

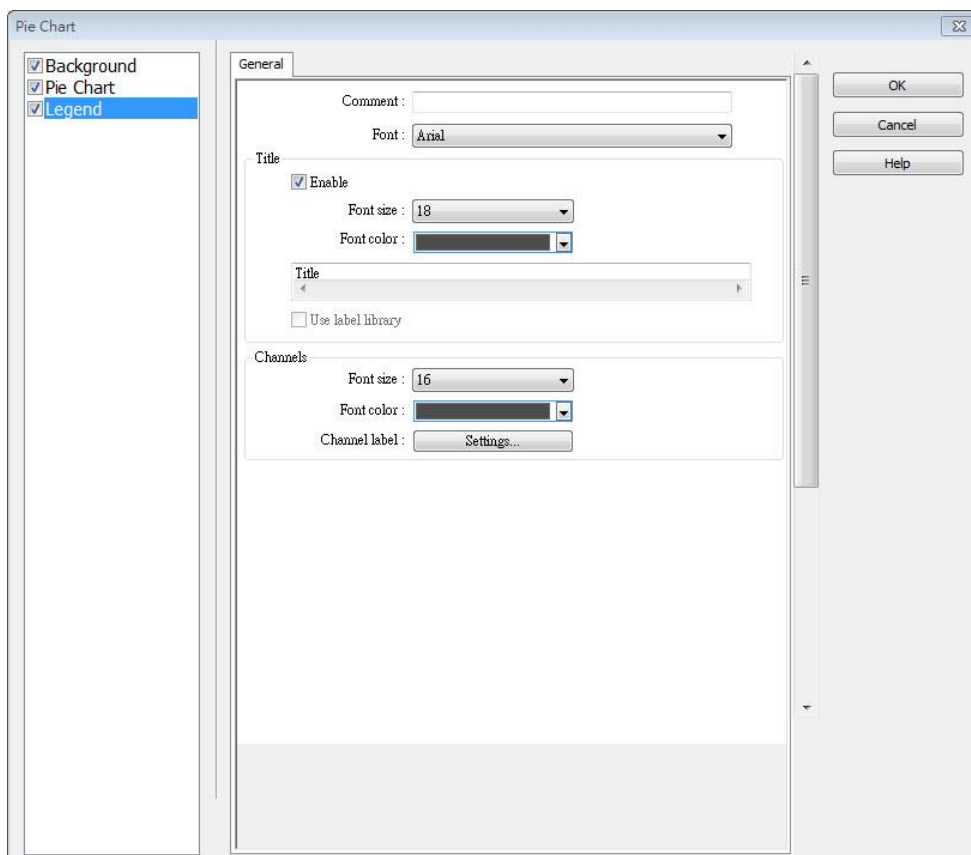

Setting	Description
Title	Set whether to use a title for Pic Chart, and set the font size / font color of the title. The title can be selected from Label Library.
Channel	Set the channel label. When using Label Library, the number of the channels should be the same as the number of states in the library.

13.42. 2D Barcode Display

13.42.1. Overview

The 2D Barcode Display object transfers the information from the read address into QR Code or Aztec Code.

13.42.2. Configuration



Click the 2D Barcode Display icon on the toolbar to open the property dialog box. Set up the properties, press OK button, and a new 2D Barcode Display object will be created.

General Tab

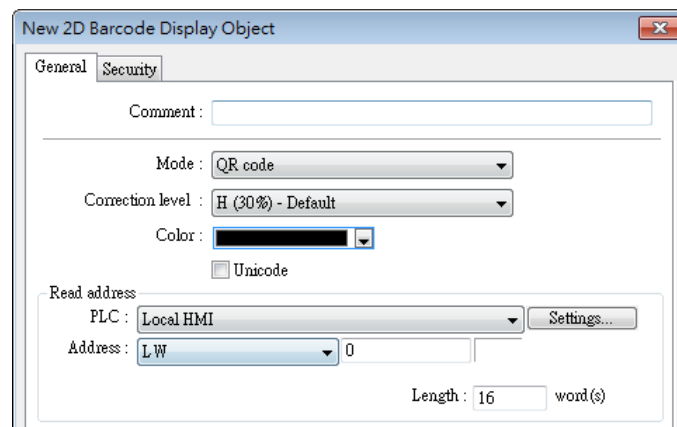

Setting	Description										
Mode	Supports QR code and Aztec code.										
Correction level	<p>2D barcodes have error correction capability to restore data if the barcode is dirty or damaged.</p> <p>QR code</p> <p>Four correction levels are available: L, M, Q, and H. The data restoration rate is listed below. (The data restoration rate for total codewords. Codeword is a unit that constructs the data area.)</p> <table border="1"> <thead> <tr> <th colspan="2">Correction Level</th> </tr> </thead> <tbody> <tr> <td>L</td> <td>7%</td> </tr> <tr> <td>M</td> <td>15%</td> </tr> <tr> <td>Q</td> <td>25%</td> </tr> <tr> <td>H</td> <td>30%</td> </tr> </tbody> </table> <p>Aztec code</p> <p>Aztec code supports error correction levels from 5% to 95%. Specifying a higher correction value results in a larger printed symbol and increases accuracy.</p>	Correction Level		L	7%	M	15%	Q	25%	H	30%
Correction Level											
L	7%										
M	15%										
Q	25%										
H	30%										

Color	Set the 2D barcode color.
UNICODE	By default, the 2D barcode is generated via ASCII encoding. If this check box is selected, the 2D barcode is generated via UNICODE encoding. For characters that are not ASCII defined English alphabets or numbers, for example, Chinese or Korean characters, please select the Unicode check box.
Read address	The 2D Barcode Display object will display the 2D barcode generated from the information entered by the read address. The word length limit: 1 ~ 1024.

13.43. String Table

13.43.1. Overview

By pre-configuring the texts and their corresponding numbers in the String Table, the text can be changed dynamically on HMI. String Table can also be used in a multi-language environment.

13.43.2. Configuration

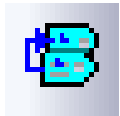

Click the String Table icon on the toolbar to open the property dialog box. Set up the properties, press OK button, and a new String Table object will be created.

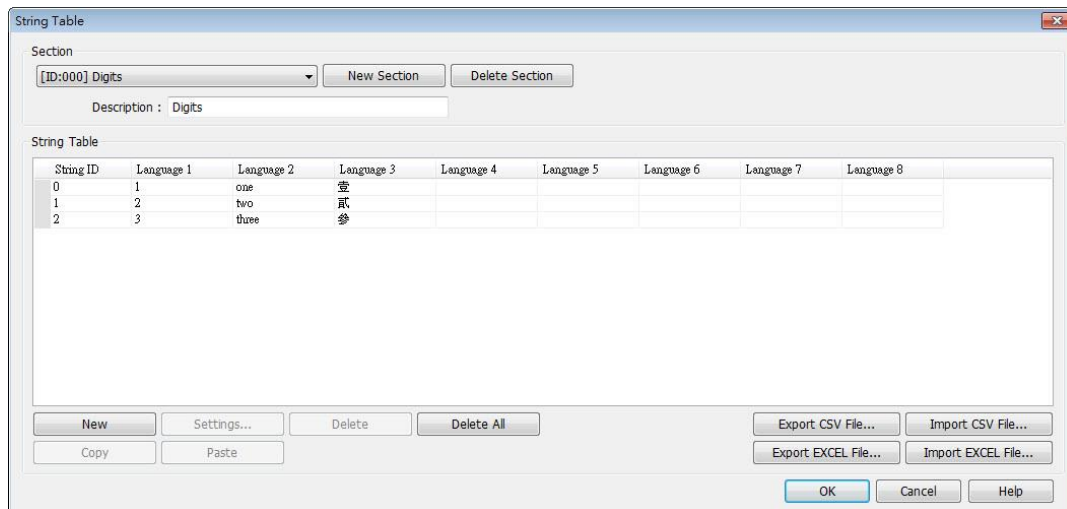

Setting	Description
Section	A list of all the existing String Tables. [New Section] Add a new String Table. [Delete Section] Delete the selected String Table.
New	Add a new string in the table.
Settings	Set the content of the selected string.
Export CSV File...	Export all the existing String Tables as a *.csv file.
Import CSV File...	Import *.csv file into the String Table.
Export EXCEL File...	Export all the existing String Tables as a *.xls file.
Import EXCEL File...	Import *.xls file into the String Table.

Note

- The font of multiple languages in the String Table must be specified in Label Text Library.

Example 1

1. Create a String Table using the same settings as the preceding figure.
2. Create a Text object, select [Use string table] check box. In String ID group box, select [Dynamic] and set read address to LW-0.

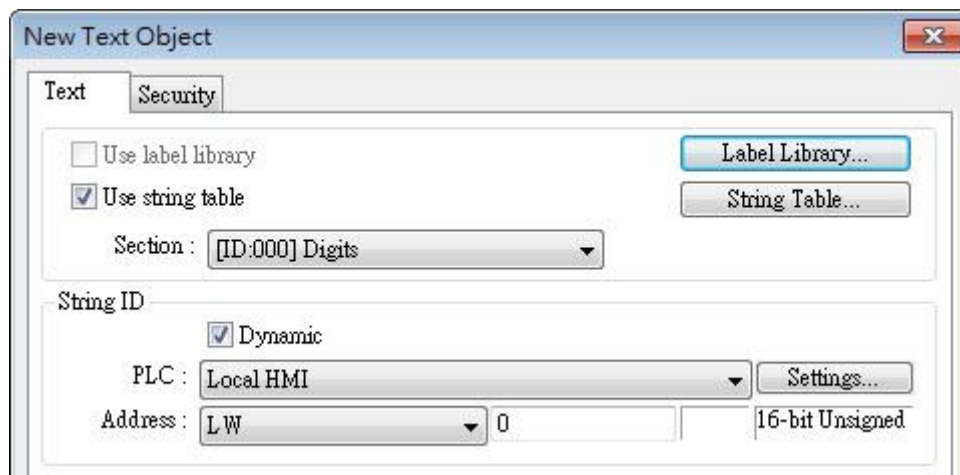

3. Create a Numeric object, set address to LW-0.
4. When the value in LW-0 is 0, the No. 0 string is displayed; when the value in LW-0 is 1, the No. 1 string is displayed.

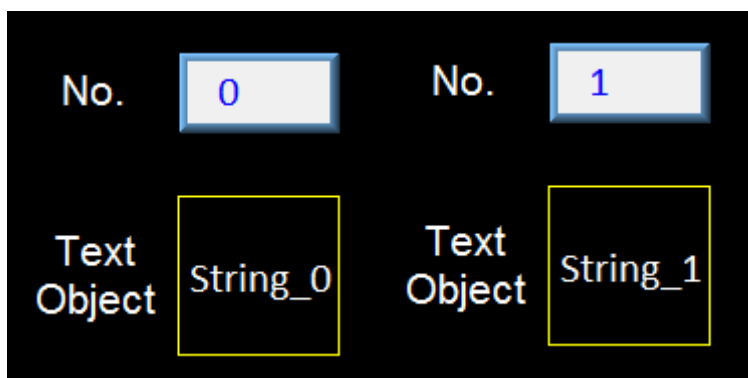

13.44. Database Server

13.44.1. Overview

Database Server object enables HMI to connect the MySQL database server in PC, allowing the user to send sampled data or event log to the MySQL database server in PC.

13.44.2. Configuration



Click the Database Server icon on the toolbar to create a Database Server object. Or, click [Object] » [Database Server] in the menu.

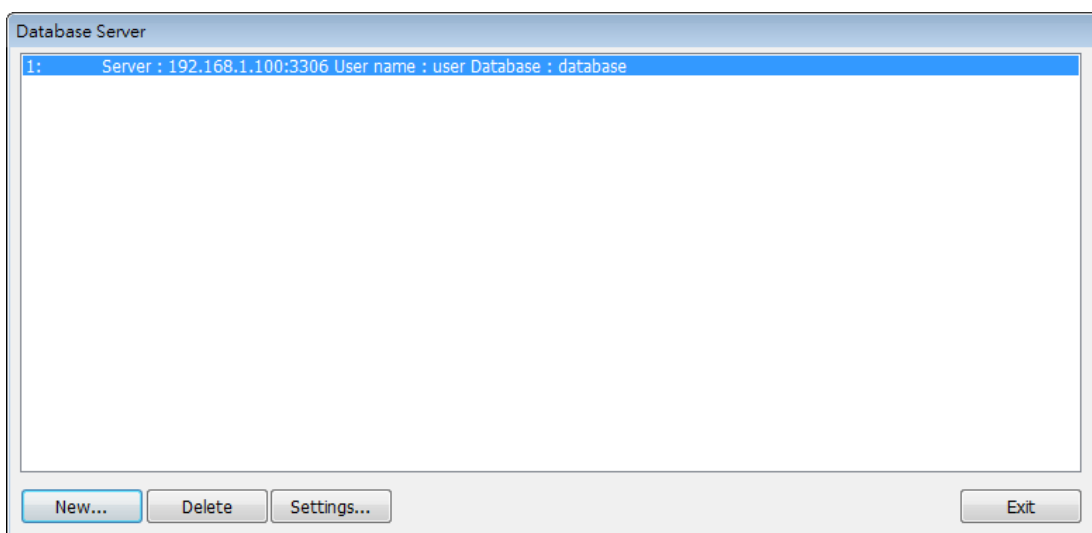

General Tab

Setting	Description
IP	Enter the IP address of the database.
Use domain name	IP : <input type="text" value="127.0.0.1"/> <input checked="" type="checkbox"/> Use domain name A domain name can be used as MQTT server's IP address.
Port	Enter the port number of the database.
Username	Enter the username for connecting the database. The maximum is 32 words.
Password	Enter the password for connecting the database. The maximum is 32 words.
Database name	Enter the name of the database for collecting historical data.

Status/Control Tab

Setting	Description													
Status address	LW-n: Displays the connection status of Database Server.													
	<table border="1"> <thead> <tr> <th>Value</th> <th>Description</th> </tr> </thead> <tbody> <tr> <td>0</td> <td>Not attempting to connect to database.</td> </tr> <tr> <td>1</td> <td>Failed to connect to database.</td> </tr> <tr> <td>2</td> <td>Connection succeeded.</td> </tr> </tbody> </table> LW-n+1: Error indicator. <table border="1"> <thead> <tr> <th>Value</th> <th>Description</th> </tr> </thead> <tbody> <tr> <td>0</td> <td>No error</td> </tr> <tr> <td>1 or more</td> <td>An error occurred</td> </tr> </tbody> </table>	Value	Description	0	Not attempting to connect to database.	1	Failed to connect to database.	2	Connection succeeded.	Value	Description	0	No error	1 or more
Value	Description													
0	Not attempting to connect to database.													
1	Failed to connect to database.													
2	Connection succeeded.													
Value	Description													
0	No error													
1 or more	An error occurred													
Control address	LW-n: Controls the operation of Database Server.													
	<table border="1"> <thead> <tr> <th>Value</th> <th>Description</th> </tr> </thead> <tbody> <tr> <td>0</td> <td>Ready</td> </tr> <tr> <td>1</td> <td>Start</td> </tr> <tr> <td>2</td> <td>Stop</td> </tr> <tr> <td>3</td> <td>Update</td> </tr> </tbody> </table> LW-n+1: Sets the IP address of the database. LW-n+5: Sets the port number of the database. LW-n+6: Sets the username for connecting database. LW-n+22: Sets the password for connecting database. LW-n+38: Sets the name of the database for collecting historical data.	Value	Description	0	Ready	1	Start	2	Stop	3	Update			
Value	Description													
0	Ready													
1	Start													
2	Stop													
3	Update													

- If sampled data is successfully synchronized to the SQL database, three tables will be generated in the database, and the sampled data is saved in *_data table.

Table	Description
<HMI NAME> <DATALOG NAME> data	Saves data sampling
<HMI NAME> <DATALOG NAME> data format	System folder
<HMI NAME> <DATALOG NAME> data section	System folder

- When synchronizing event log, the three tables generated in the database are listed as the following table, and the event log is saved in *_event table.

Table	Description
<HMI NAME> _event	Saves event log
<HMI NAME> _event_log	System folder
<HMI NAME> _event_update_time	System folder

- If the content of data sampling / event log, such as data format or event message, is changed and downloaded to HMI, please delete the tables listed above first, and then the new content will thus be effective.

Example 1

- Create a Database Server object, set Status Address to LW-0, and Control Address to LW-10.

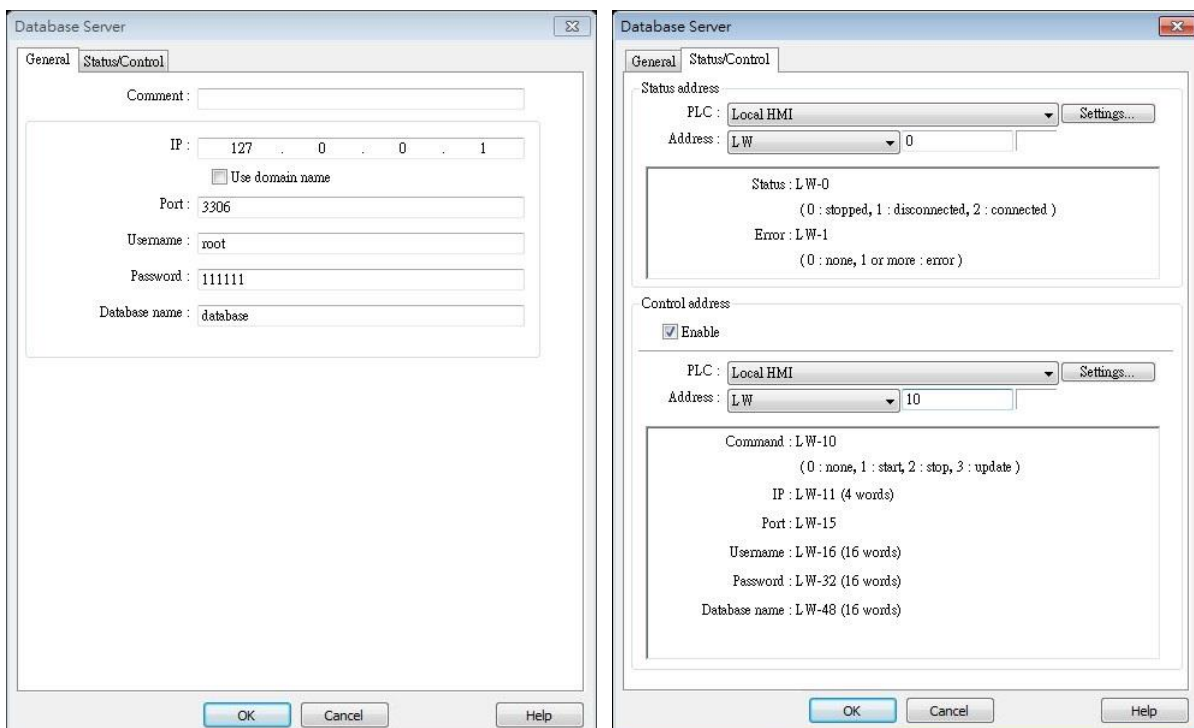

- Create a Data Sampling object, in [Sync. to database] group box select [Enable], and set Control Address to LW-80, to update or clear HMI historical data.

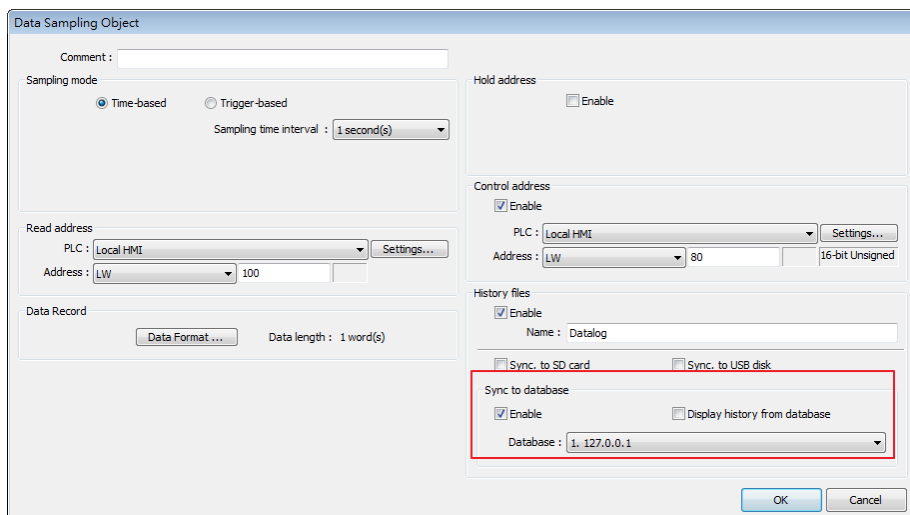

3. If the database is successfully connected, the status indicator LW-0 displays 2 (connection succeeded), and the error indicator LW-10 displays 0 (no error).
4. Write 2 in LW-80 (sync. data). Open SQL database, the data can be found in table <HMI NAME>_<DATALOG NAME>_data.

	Table	Action	Records	Type	Collation	Size	Overhead
<input type="checkbox"/>	hostname_datalog_data		6	MyISAM	utf8_unicode_ci	2.1 KiB	-
<input type="checkbox"/>	hostname_datalog_data_format		1	MyISAM	utf8_unicode_ci	2.0 KiB	-
<input type="checkbox"/>	hostname_datalog_data_section		0	MyISAM	utf8_unicode_ci	1.0 KiB	-
	3 table(s)	Sum	7	MyISAM	utf8_unicode_ci	5.2 KiB	0 B

13.45. Dynamic Scale

13.45.1. Overview

Dynamic Scale offers customizable tick marks and scale labels and can be used together with objects such as Trend Display, Bar Graph..., etc.

13.45.2. Configuration



Click the Dynamic Scale icon on the toolbar to open a Dynamic Scale object property dialog box. Set up the properties, press OK button, and a new Dynamic Scale object will be created.

General Tab

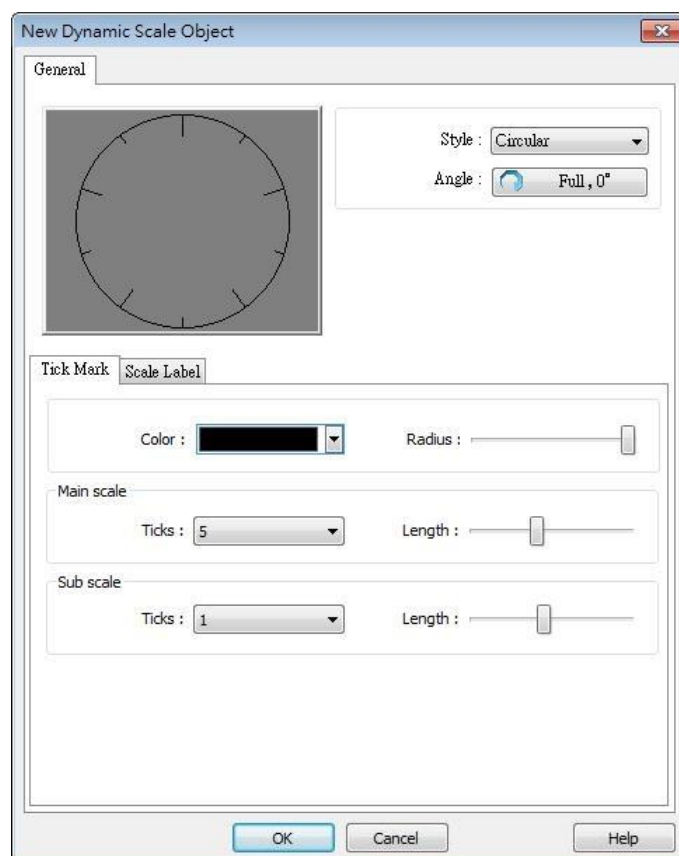

Setting	Description
Style	Select the style from [Circular], [Horizontal], or [Vertical]. If select [Circular], set the [Direction] and [Degree].

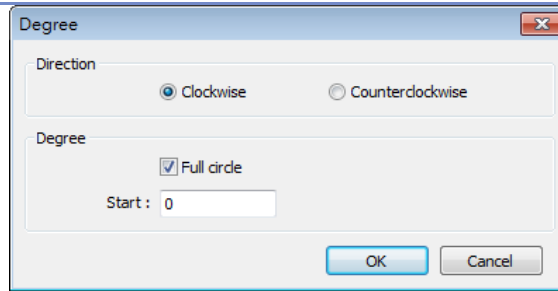
**Direction**

Select from [Clockwise] or [Counterclockwise].

Degree

If [Full circle] is selected, set the start degree.

If [Full circle] is not selected, set the start and end degree.

**Tick Mark**

Select the color of the tick mark, and set the number of ticks for the main and sub scale (major and minor tick mark).

For [Circular] style, the length of the major and minor tick mark, and the radius of the circular tick mark can be set.

Scale Label

Displays major tick labels.

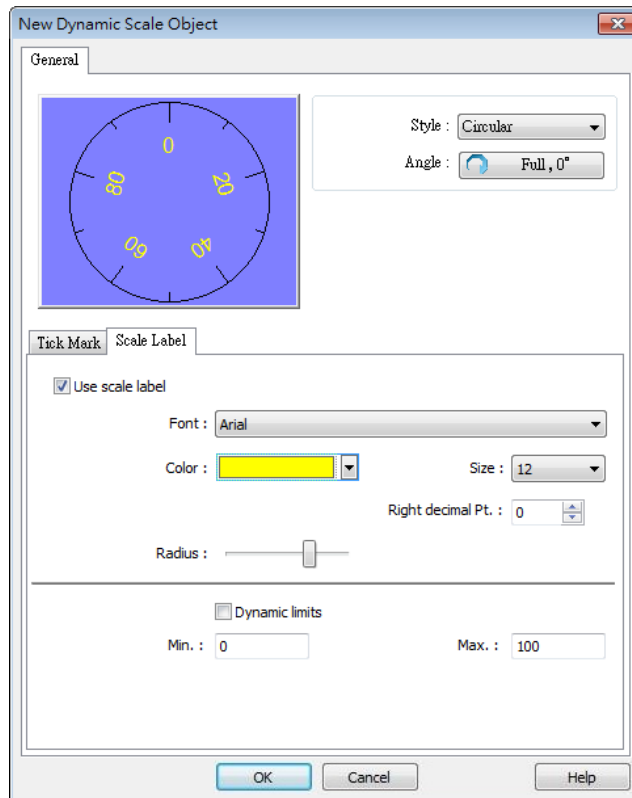
Circular

Set the font, font color, font size, and decimal point of the scale

label.

Set the radius start from the center of the object to the position to place the scale label.

Vertical / Horizontal

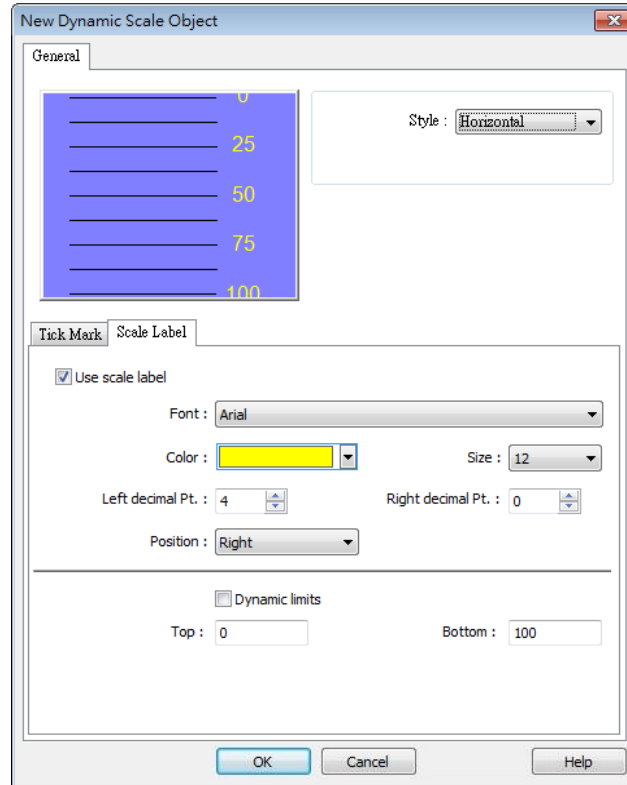

Set the font, font color, font size, and decimal point of the scale label.

Set the position to display the scale label.

The Max. and Min. limits of the scale label can be specified. If [Dynamic limits] is selected, the Max. and Min. limits can be set by the designated word addresses.

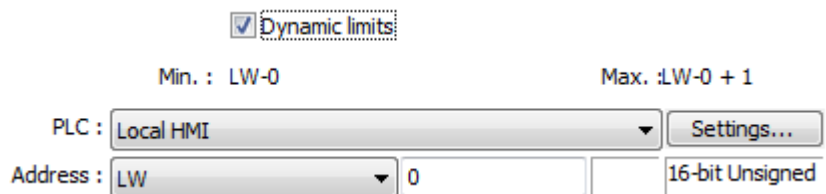

13.46. Dynamic Drawing

13.46.1. Overview

Dynamic Drawing object enables drawing a shape in a specified region on HMI screen at run time. The shape can be a line, a rectangle, a circle, or a dot. By setting the Attributes Addresses, the style and the color of the shape can be customized.

13.46.2. Configuration

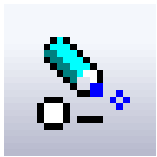

Click the Dynamic Drawing icon on the toolbar to open a Dynamic Drawing object property dialog box. Set up the properties, press OK button, and a new Dynamic Drawing object will be created.

General Tab

The screenshot shows the 'Dynamic Drawing Object's Properties' dialog box with the 'General' tab selected. The dialog has three tabs: 'General', 'Color', and 'Profile'. The 'Clear address' section has 'PLC' set to 'Local HMI' and 'Address' set to 'LB' with a value of '0'. The 'Attributes address' section has 'PLC' set to 'Local HMI' and 'Address' set to 'LW' with a value of '0'. Below these are several attributes for customization:

- LW-0 + 0 : shape (0: none, 1: line, 2: rectangle, 3: circle, 4: dot)
- LW-0 + 1 : arrow/shape style ([more](#))
- LW-0 + 2 : line/fill style ([more](#))
- LW-0 + 3 : inner color
- LW-0 + 4 : interior pattern color (rectangle, circle)
- LW-0 + 5 : x1
- LW-0 + 6 : y1
- LW-0 + 7 : x2 (circle radius)
- LW-0 + 8 : y2

* (x1, y1) : start point (line, rectangle), center (circle)
 (x2, y2) : end point (line, rectangle)

At the bottom of the dialog are 'OK', 'Cancel', and 'Help' buttons.

















Setting	Description
Clear Address	Clears the drawing.
Attributes Address	Changes the attributes in the drawing.

Entering different values in different Attributes Addresses brings different effects, as shown in the following table.

Attributes Address	Attributes Address+0	Attributes Address+1		Attributes Address+2	Attributes Address+3	Attributes Address+4
Default	0	Ones	Tens		Customizable	Customizable
Line	1	0: Non-arrow	0: Small	0: Solid line	Line color	
		1: Single-ended arrow (Hollow)	1: Large	1: Dashed line		
		2: Double-ended arrow (Hollow)		2: Dotted line		
		3: Single-ended arrow (Solid)		3: Dash Dot line		
		4: Double-ended arrow (Solid)		4: Dash Dot Dot line		
				5 and up: Solid line with thicknesses greater than 2		
Rectangle	2	0: Hollow		Drawn in Line mode	Rectangle color	Interior pattern color
		1: Solid		Drawn in Pattern mode		
Circle	3	0: Hollow		Drawn in Line mode	Circle color	Interior pattern color
		1: Solid		Drawn in Pattern mode		
Dot	4				Dot color	

Attributes Address	Attributes Address+0	Attributes Address+5	Attributes Address+6	Attributes Address+7	Attributes Address+8
Default	0				
Line	1	Start point X	Start point Y	End point X	End point Y
Rectangle	2	Left-top point X	Left-top point Y	Right-bottom point X	Right-bottom point Y
Circle	3	Center point X	Center point Y	Radius	
Dot	4	Dot X	Dot Y		

The values in [Attributes Address+2] represent different Line or Pattern styles, as shown in the following table.

Line mode	Pattern mode
0 	0 
1 	1 
2 	2 
3 	3 
4 	4 
5 	5 
6 	6 
⋮	⋮
19 	19 

Color Tab

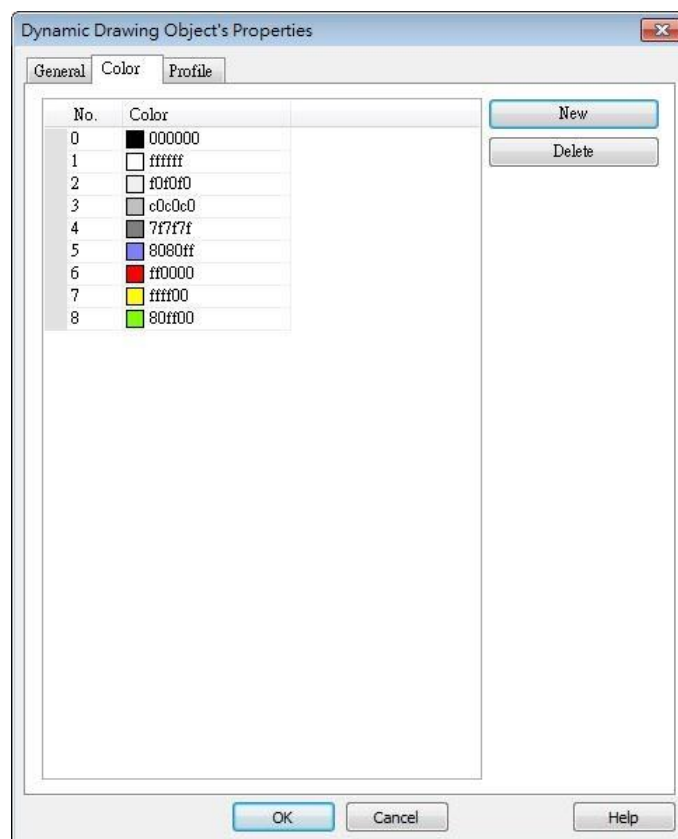

Setting	Description
New	Adds a color to be used in the drawing.
Delete	Deletes the selected color.

Example 1

The following demo project demonstrates how to dynamically draw an arrow or a circle on HMI screen. To build the project, follow these steps:

1. Create a Dynamic Drawing object, set Clear Address to LB-0, and Attributes Address to LW-0.
2. Create a Toggle Switch object, set address to LB-0, and select Toggle as switch style, for clearing the drawing.
3. Create 9 Numeric objects, set addresses to LW-0~LW-8, for specifying the attributes in the drawing.
4. Run simulation or download the project to HMI to see the result. By entering 1 in LW-0, a line is drawn, and entering different values in LW-1~8 can change the style, the color, and the position of the line.

Demo Project - Dynamic Drawing
 -> Dynamically changing pattern on HMI!
 -> Drawing line/rectangle/circle/dot in specified region!

Clear Pattern

0000	Attributes + 0: shape (0: none, 1: line, 2: rectangle, 3: circle, 4: dot)
0001	Attributes + 1: arrow/shape style
0001	Attributes + 2: line/fill style
0005	Attributes + 3: inner color
0000	Attributes + 4: interior pattern color (rectangle,circle)
0000	Attributes + 5: X1
0000	Attributes + 6: Y1
0300	Attributes + 7: X2(circle radius)
0300	Attributes + 8: Y2

Fast Sel

5. Press Clear Pattern button, and enter 3 in LW-0, a circle is drawn, and entering different values in LW-1~8 can change the style, the color, and the position of the circle.

Demo Project - Dynamic Drawing

-> Dynamically changing pattern on HMI!
-> Drawing line/rectangle/circle/dot in specified region!

Clear Pattern

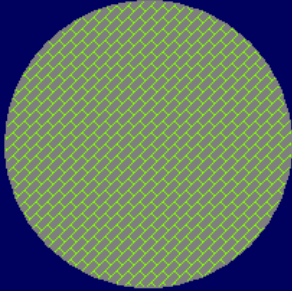

0000	Attributes + 0: shape (0: none, 1: line, 2: rectangle, 3: circle, 4: dot)
0001	Attributes + 1: arrow/shape style
0025	Attributes + 2: line/fill style
0004	Attributes + 3: inner color
0008	Attributes + 4: interior pattern color (rectangle,circle)
0150	Attributes + 5: X1
0150	Attributes + 6: Y1
0100	Attributes + 7: X2(circle radius)
0000	Attributes + 8: Y2

Fast Sel

Note

- Before using Attributes Address, please define [Attributes Address + 1] ~ [Attributes Address + 8]. The system will reset the Attributes Address, after it is used.
- If the drawing is not cleared, the new drawing will overlap the previous one, and the maximum acceptable number of drawings in a Dynamic Drawing object is 1000.
- The maximum number of line styles is 19, which means the maximum thickness of a solid line is 16. The style numbers that exceed 19 will be displayed as 19.
- Find the color number in Color tab.

13.47. PDF Reader

13.47.1. Overview

PDF Reader object enables viewing of PDF documents on HMI.

Please note that this object is currently available only for cMT3151 model, with OS version 20160301 and later.

13.47.2. Configuration



Click the PDF Reader icon on the toolbar to create a PDF Reader object. Or, click [Object] » [PDF Reader] in the menu.

General Tab

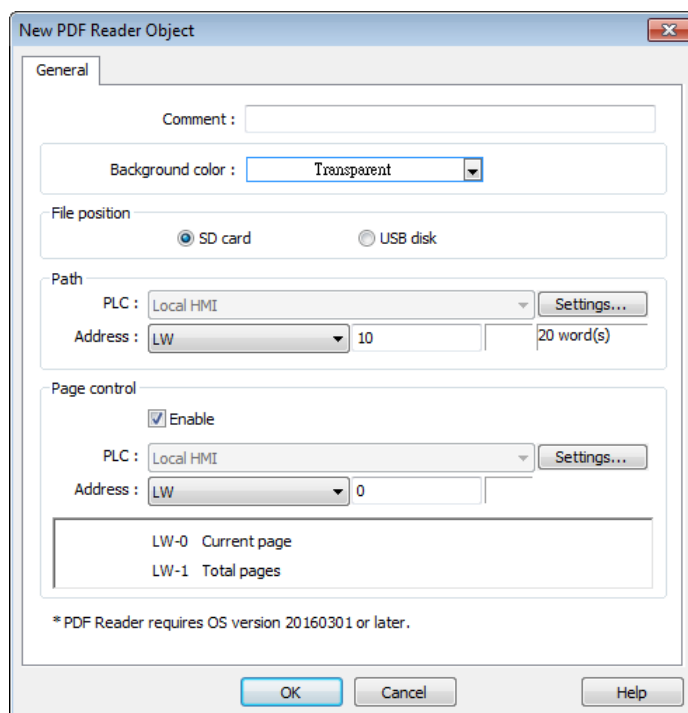

Setting	Description
File position	Select the position where the PDF file is stored.
Path	The directory of the PDF file stored in the external device.
Page Control	Change the displayed page by entering its page number.

 **Note**

- PDF Reader can only run on cMT3151, and cannot be opened using simulation mode or cMT Viewer.
- The PDF files protected by passwords or restrictions cannot be read using PDF Reader.
- CPU loading may rise when multiple PDF Reader objects are opened simultaneously.
- When entering a page number in the Page Control register under multi-page view mode, the specified page will be opened in single-page view.



Click the icon to download the demo project. Please confirm your internet connection before downloading the demo project.

13.48. Table

13.48.1. Overview

Table object allows users to draw a table in the editing window, and customize the border, grid, and pattern of the table.

13.48.2. Configuration

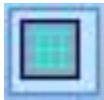

Click the Table icon on the toolbar to create a Table object. Or, click [Draw] » [Table] in the menu.

General Tab

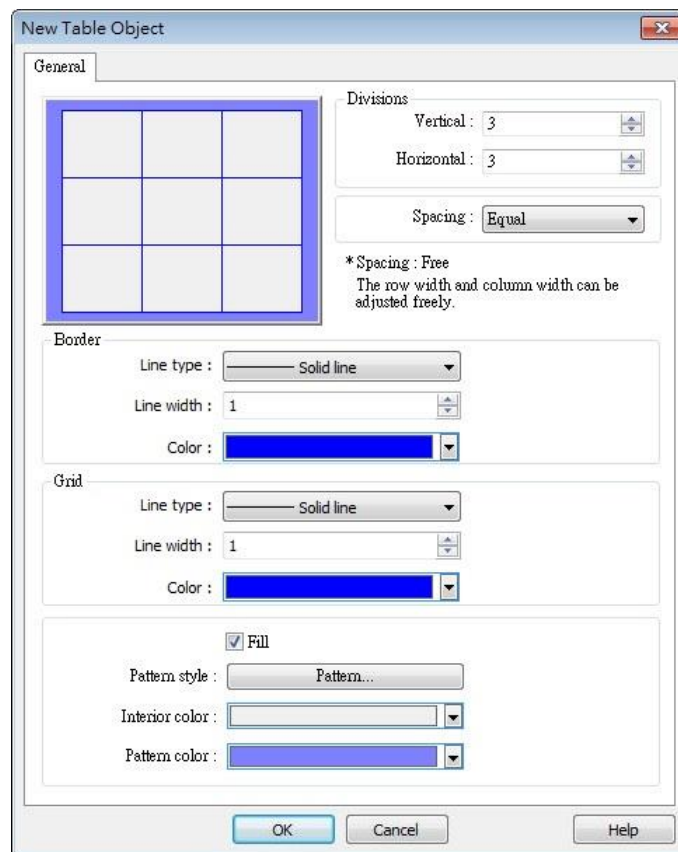

Setting	Description
Preview Window	Displays the settings result.
Vertical	Sets the number of columns in the table. Range: 1~255

Horizontal	Sets the number of rows in the table. Range: 1~255
Spacing	The available options are [Equal] and [Free]. When [Free] is selected, the user can manually adjust the column width or row height in the editing window.
Border	Sets the type, width, and color of the border. [Line width] setting is available only when Solid line type is selected. The range of width is 0~8. The line will become invisible when the width is set to 0.
Grid	Sets the type, width, and color of the grid. [Line width] setting is available only when Solid line type is selected. The range of width is 0~8. The line will become invisible when the width is set to 0.
Fill	Sets the pattern style and color.

13.49. VNC Viewer

13.49.1. Overview

VNC Viewer can run on HMI to control a PC or a device remotely. VNC server must be installed on the remote device to be connected. On HMI the user can monitor and control the remote device.

13.49.2. Configuration



Click on the VNC Viewer icon on the toolbar or select [Objects] » [VNC Viewer] to open the settings dialog box. Configure the parameters and click OK; a VNC Viewer object will be created.

General Tab

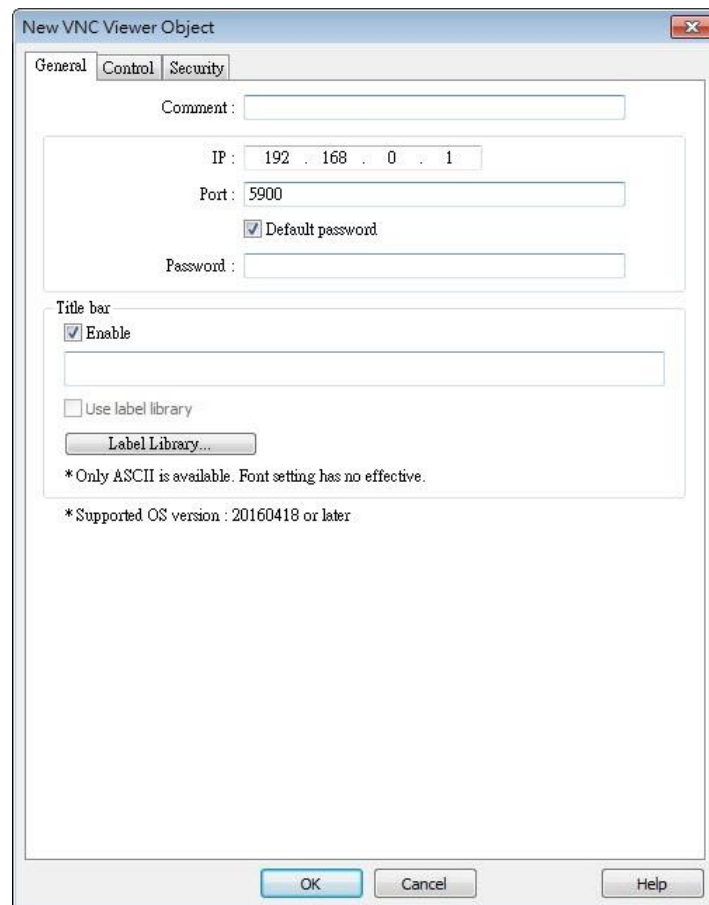

The screenshot shows the 'New VNC Viewer Object' dialog box with the 'General' tab selected. The dialog has three tabs: 'General', 'Control', and 'Security'. The 'General' tab contains the following fields and options:

- Comment:** A text input field.
- IP:** A text input field containing '192 . 168 . 0 . 1'.
- Port:** A text input field containing '5900'.
- Default password:** A checked checkbox.
- Password:** A text input field.
- Title bar:**
 - Enable:** A checked checkbox.
 - A text input field for the title bar text.
 - Use label library:** An unchecked checkbox.
 - Label Library...:** A button.
- Footnote 1:** * Only ASCII is available. Font setting has no effective.
- Footnote 2:** * Supported OS version : 20160418 or later.

At the bottom of the dialog are three buttons: 'OK', 'Cancel', and 'Help'.

Setting	Description
IP	Enter the IP address of the remote device to be connected.
Port	Enter the port number of the remote device to be connected.
Default Password	Enter the VNC password to log in the VNC server of the remote device. If Default Password is enabled, when connecting the remote device, VNC Viewer will automatically use the password specified here to log in, and the user doesn't need to enter the password.
Title bar	Enable When [Enable] is selected, a field shows for entering the caption in the title bar. The caption is limited to ASCII characters, and the font cannot be customized. The caption can be selected from Label Tag Library. Only when the title bar is enabled can the VNC Viewer window be moved or resized by dragging.



Note

- VNC Viewer requires OS version 20160418 or later.
- VNC Viewer is applicable for eMT/iE/XE Series and cMT3151 HMI models.
- VNC Viewer cannot be simulated in on-line simulation mode.
- When [Default password] is selected, HMI's Virtual Keyboard can only be called out manually. If [Default password] is not selected, the Virtual Keyboard can pop up automatically.

Control Tab

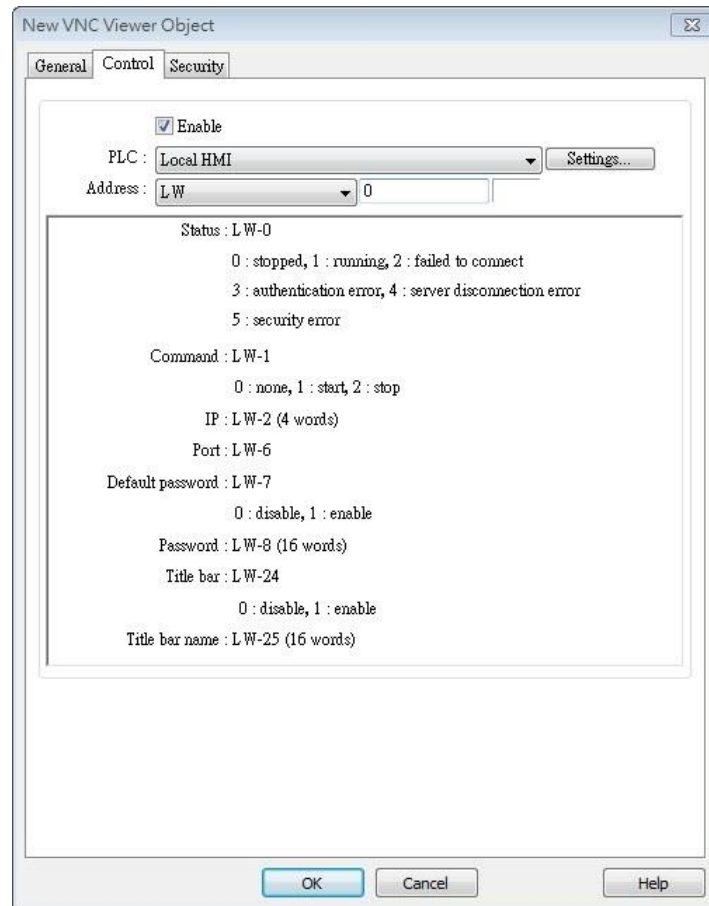

Setting

Description

IP

A set of word addresses can be specified to control VNC Viewer as well to display the connection status.

Control address: Shows the connection status

0: Stopped

1: Running

2: Failed to connect

3: Authentication error

4: Server disconnection error

5: Security error

Control address + 1: Command

0: None

1: Start

2: Stop

Control address+2~+5: IP

Control address+6: Port Number

Control address+7: Default Password

0: Disable

1: Enable

Control address+8: Password (16 words)

Control address+24: Title bar

0: Disable

1: Enable

Control address+24: Title bar name (16 words)

Note

- The allowable value range that can be entered in Control Address+6 is 0~99. The actual Port Number will be the value entered in Control Address+6 plus 5900. For example, if the user enters 1 in Control Address+6, the actual Port Number will be 5901. However, if the user enters 100 in Control Address+6, the value will not be added by 5900, and the actual Port Number will be 100.
- In VNC Viewer, to use the HMI built-in Virtual Keyboard, please tap the Focus button on the Virtual Keyboard first, and then tap VNC Viewer screen. This will change the input target.

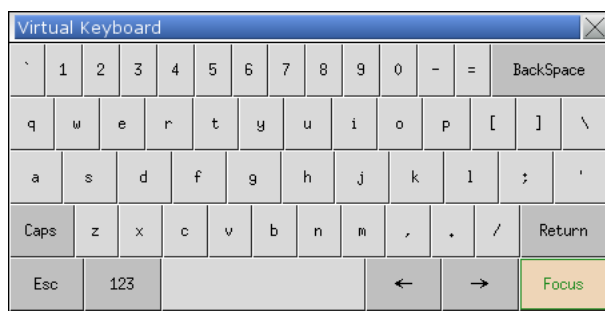

-  Click the icon to download the demo project. Please confirm your internet connection before downloading the demo project.

13.50. Barcode Scanner (Android Camera)

13.50.1. Overview

By connecting an Android device (phone/tablet) equipped with a camera to an HMI (cMT-SVR/cMT3151) using cMT Viewer installed on the Android device, the camera can be used to scan 1D or 2D barcodes.

13.50.2. Configuration

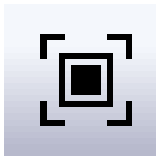

Click the Barcode Scanner icon on the toolbar to create a Barcode Scanner object. Or, click [Objects] » [Barcode Scanner] in the menu.

General Tab

Barcode Scanner (Android Camera) Object's Properties

General Security Profile

Comment :

Control address

PLC : Local HMI

Address : LW

Command : LW-0
(0 : none, 1 : start and clear, 2 : stop, 3 : clear)

Execution status : LW-1
(0 : none, 1 : success, 2 or more : error code)

Data length : LW-2

Status address

PLC : Local HMI

Address : LB

Camera Status : LB-0
(0 : off, 1 : on)

Running Status : LB-1
(0 : stopped, 1 : scanning)

Barcode address

PLC : Local HMI

Address : LW 20 word(s)

Use Unicode

Read byte limit

Enable Limit : Bytes

Setting	Description
Control address	Control address: Gives Command to Barcode Scanner. 0: None 1: Start and Clear 2: Stop 3: Clear Control address + 1: Shows Execution Status. 0: None 1: Success 2 or more: Error Code Control address + 2: Shows data length scanned.
Status address	Status address: Shows camera status is On / Off. 0: Off 1: On Status address + 1: Shows whether scanning is ready. 0: Stopped 1: Ready for scanning
Barcode address	The address that stores the data read, UNICODE is allowed.
Read byte limit	If the data read exceeds this setting, the execution status turns to 2 (error code).

Security Tab

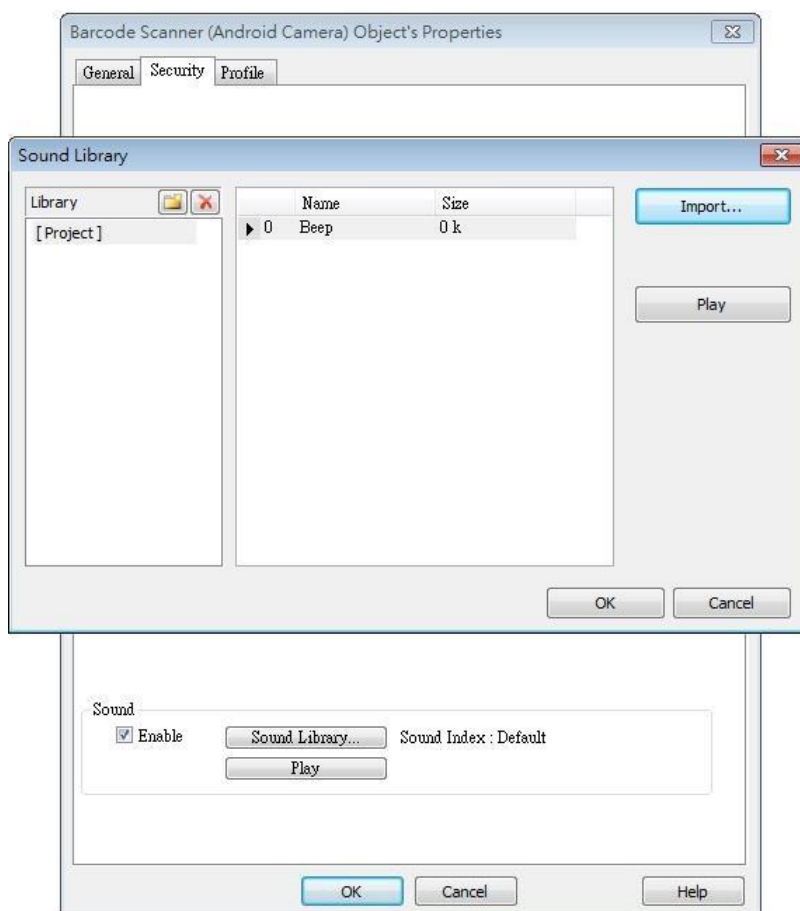

Setting	Description
Sound	If Enable is selected, when data is read, a sound is emitted. The supported sound file format is .wav.

 Note

- Barcode Scanner is currently supported on cMT-SVR and cMT3151 models. Barcode Scanner cannot be opened using simulation mode or cMT Viewer.
- Supports: EAN/UPC, Code 128, Code 39, Interleaved 2 of 5 and QR Code.
- On the device, if other applications are also using the camera, or the camera is locked, cMT Viewer may not operate properly.
- In the project, when multiple cMT Viewer devices are connected, since the same address is shared between the devices, the devices will simultaneously scan if they are displaying the same window with Barcode Scanner.

Example 1

The following demo project shows how to scan QR code using a tablet.

1. At the beginning, the display is dark.

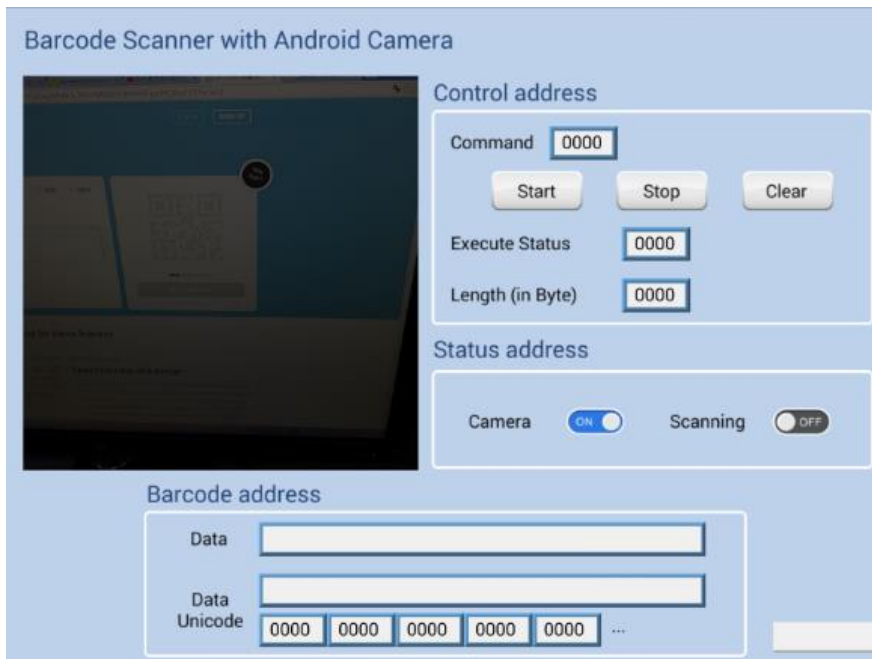

2. Tap Start button, the status of Scanning turns ON, the display turns bright, and is ready for scanning.

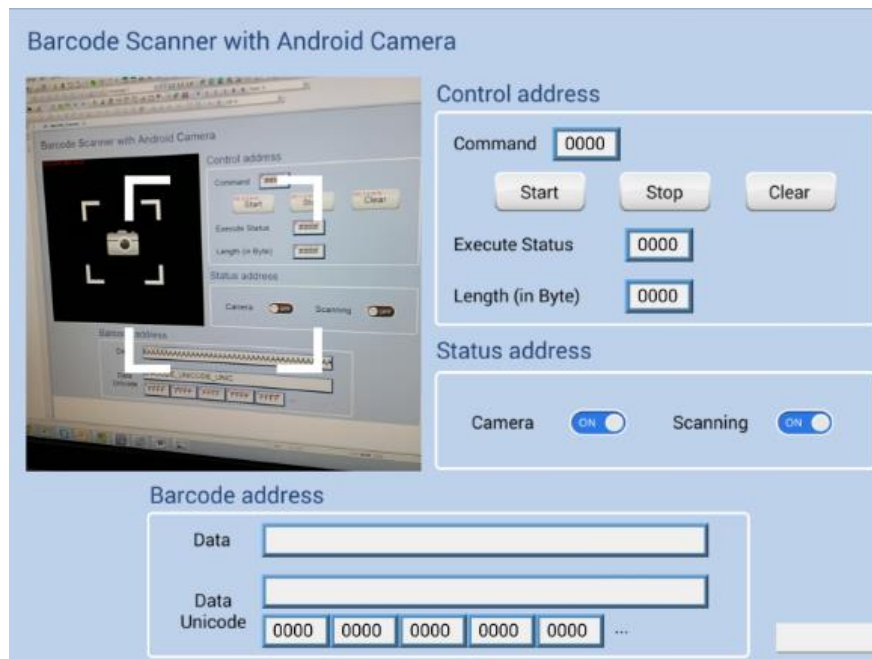

3. When a QR code is read, the Execute Status turns 1, and the QR code is captured, its content will be displayed in Barcode Address group box. Unicode is also supported.

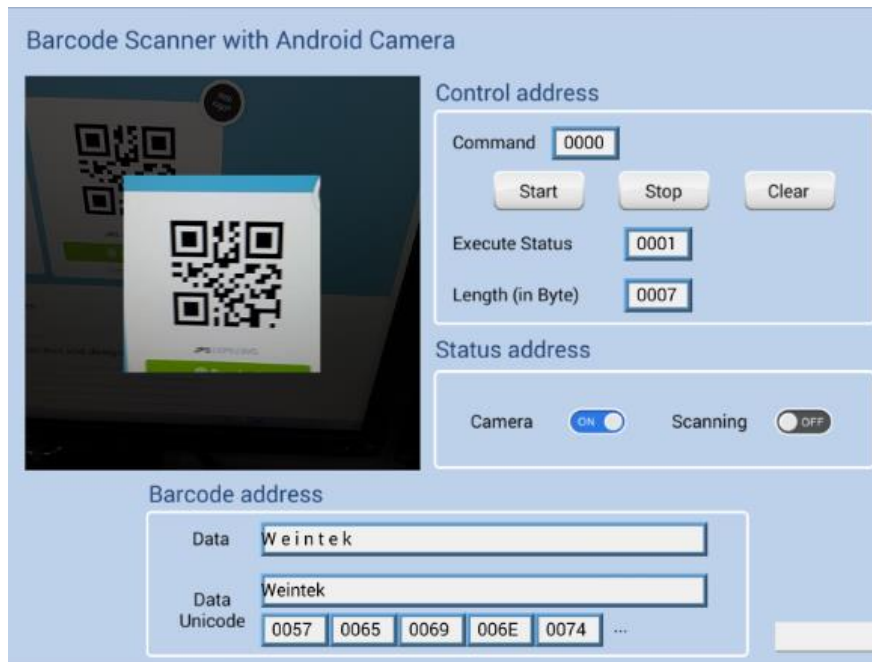

4. If the size of the data read exceeds the maximum allowable size set in Read Byte Limit (10 bytes in this project), the Execution Status turns to 2 (error code). The exceeding part will still be displayed in the ASCII objects in Barcode Address group box, since the data length displayed depends on the ASCII object settings (20 words in this project).

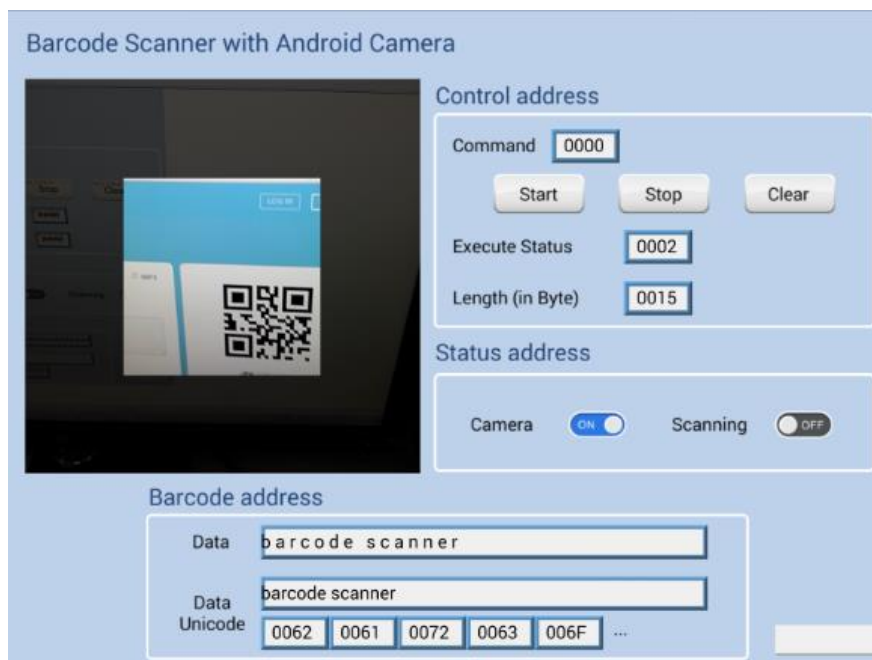

5. After changing to another page, Scanning turns OFF, the parameters are reserved. The parameters will be cleared when next time Start button is tapped, or Clear button is tapped.

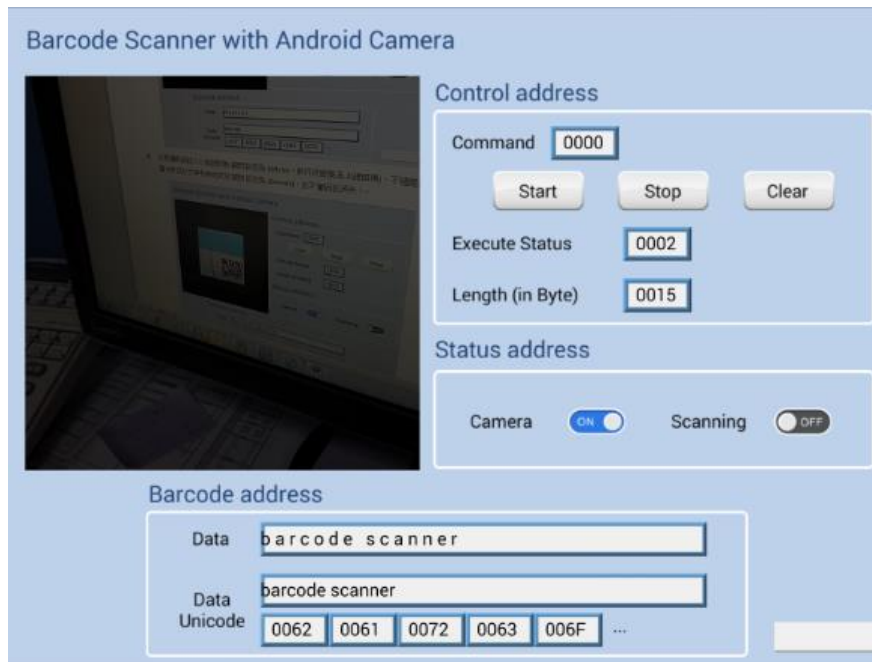

Click the icon to download the demo project. Please confirm your internet connection before downloading the demo project.

13.51. Contacts Editor

13.51.1. Overview

Contacts Editor enables users to dynamically add / modify / delete email contacts on HMI.

13.51.2. Configuration



Click the Contacts Editor icon on the toolbar to create a Contacts Editor object. Or, click [Objects] » [Contacts Editor] in the menu.

General Tab

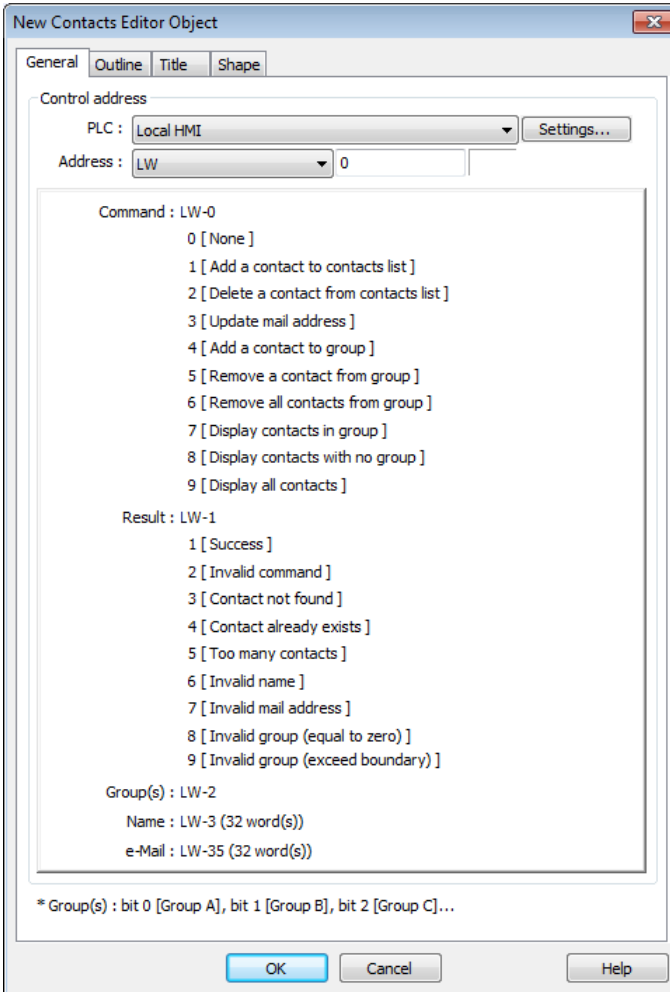

The image shows a dialog box titled "New Contacts Editor Object" with a close button in the top right corner. It has four tabs: "General", "Outline", "Title", and "Shape", with "General" selected. The "General" tab contains the following fields and options:

- Control address**
 - PLC: Local HMI (dropdown menu) with a "Settings..." button to its right.
 - Address: LW (dropdown menu) and 0 (text input field).
- Command : LW-0**
 - 0 [None]
 - 1 [Add a contact to contacts list]
 - 2 [Delete a contact from contacts list]
 - 3 [Update mail address]
 - 4 [Add a contact to group]
 - 5 [Remove a contact from group]
 - 6 [Remove all contacts from group]
 - 7 [Display contacts in group]
 - 8 [Display contacts with no group]
 - 9 [Display all contacts]
- Result : LW-1**
 - 1 [Success]
 - 2 [Invalid command]
 - 3 [Contact not found]
 - 4 [Contact already exists]
 - 5 [Too many contacts]
 - 6 [Invalid name]
 - 7 [Invalid mail address]
 - 8 [Invalid group (equal to zero)]
 - 9 [Invalid group (exceed boundary)]
- Group(s) : LW-2**
 - Name : LW-3 (32 word(s))
 - e-Mail : LW-35 (32 word(s))

At the bottom of the dialog, there is a note: "* Group(s) : bit 0 [Group A], bit 1 [Group B], bit 2 [Group C]...". At the very bottom, there are three buttons: "OK", "Cancel", and "Help".

Setting	Description																																																				
Control Address	<p>A set of word addresses can be specified to change contact list or to show results.</p> <p>Control address: Gives commands.</p> <table border="1"> <thead> <tr> <th>Value</th> <th>Command</th> </tr> </thead> <tbody> <tr><td>0</td><td>None</td></tr> <tr><td>1</td><td>Add a contact to contacts list</td></tr> <tr><td>2</td><td>Delete a contact from contacts list</td></tr> <tr><td>3</td><td>Update mail address</td></tr> <tr><td>4</td><td>Add a contact to group</td></tr> <tr><td>5</td><td>Remove a contact from group</td></tr> <tr><td>6</td><td>Remove all contacts from group</td></tr> <tr><td>7</td><td>Display contacts in group</td></tr> <tr><td>8</td><td>Display contacts with no group</td></tr> <tr><td>9</td><td>Display all contacts</td></tr> </tbody> </table> <p>Control address + 1: Shows execution result.</p> <table border="1"> <thead> <tr> <th>Value</th> <th>Result</th> </tr> </thead> <tbody> <tr><td>1</td><td>Success</td></tr> <tr><td>2</td><td>Invalid command</td></tr> <tr><td>3</td><td>Contact not found</td></tr> <tr><td>4</td><td>Contact already exists</td></tr> <tr><td>5</td><td>Too many contacts</td></tr> <tr><td>6</td><td>Invalid name</td></tr> <tr><td>7</td><td>Invalid mail address</td></tr> <tr><td>8</td><td>Invalid group (equal to zero)</td></tr> <tr><td>9</td><td>Invalid group (exceed boundary)</td></tr> </tbody> </table> <p>Control address + 2: Group(s), uses bits to represent groups.</p> <table border="1"> <thead> <tr> <th>Value</th> <th>Commands</th> </tr> </thead> <tbody> <tr><td>0</td><td>Group A</td></tr> <tr><td>1</td><td>Group B</td></tr> <tr><td>2</td><td>Group C</td></tr> <tr><td>3~15</td><td>Group D ~ Group P</td></tr> </tbody> </table> <p>Control address + 3: Name (32 word(s)), contact name</p> <p>Control address + 35: e-Mail (32 word(s)), e-mail address</p>	Value	Command	0	None	1	Add a contact to contacts list	2	Delete a contact from contacts list	3	Update mail address	4	Add a contact to group	5	Remove a contact from group	6	Remove all contacts from group	7	Display contacts in group	8	Display contacts with no group	9	Display all contacts	Value	Result	1	Success	2	Invalid command	3	Contact not found	4	Contact already exists	5	Too many contacts	6	Invalid name	7	Invalid mail address	8	Invalid group (equal to zero)	9	Invalid group (exceed boundary)	Value	Commands	0	Group A	1	Group B	2	Group C	3~15	Group D ~ Group P
Value	Command																																																				
0	None																																																				
1	Add a contact to contacts list																																																				
2	Delete a contact from contacts list																																																				
3	Update mail address																																																				
4	Add a contact to group																																																				
5	Remove a contact from group																																																				
6	Remove all contacts from group																																																				
7	Display contacts in group																																																				
8	Display contacts with no group																																																				
9	Display all contacts																																																				
Value	Result																																																				
1	Success																																																				
2	Invalid command																																																				
3	Contact not found																																																				
4	Contact already exists																																																				
5	Too many contacts																																																				
6	Invalid name																																																				
7	Invalid mail address																																																				
8	Invalid group (equal to zero)																																																				
9	Invalid group (exceed boundary)																																																				
Value	Commands																																																				
0	Group A																																																				
1	Group B																																																				
2	Group C																																																				
3~15	Group D ~ Group P																																																				

 **Note**

- General tab cannot be found when the model used is a cMT model.
- Contact names do not support Unicode.
- The number of groups is specified in [System Parameter Settings] » [e-Mail] » [Recipients]. Please note that the number of groups cannot be dynamically changed on HMI.

Outline

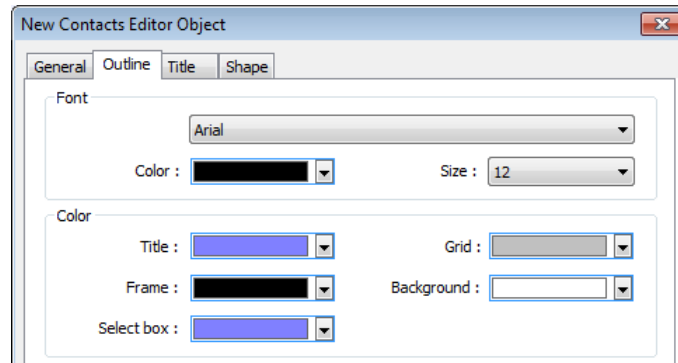

Setting	Description
Font & Color	Select Contacts Editor object's font and color.

Title

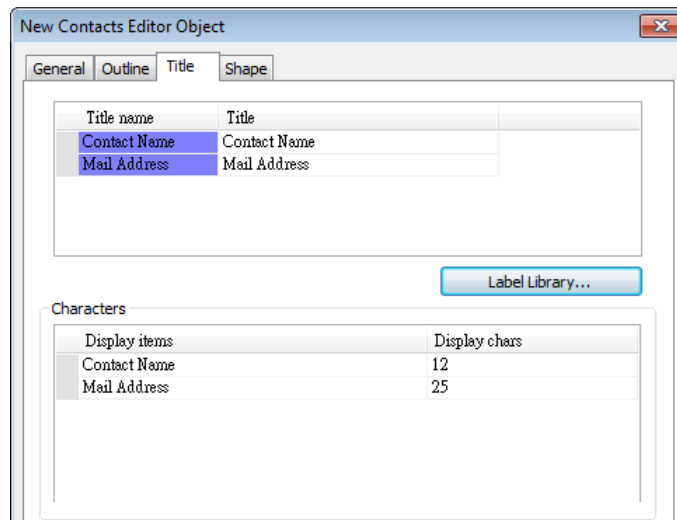

Setting	Description
Title	The title shown in Contacts Editor.
Display chars	The displayable data length of each title in Contacts Editor. Range: 1~60

14. Shape Library and Picture Library

This chapter explains how to build Shape Library and Picture Library.

14.1. Overview.....	14-2
14.2. Building Shape Library	14-2
14.3. Building Picture Library.....	14-9
14.4. Immediate Modification and Preview	14-14

14.1. Overview

EasyBuilder Pro provides Shape Library and Picture Library for visual effects on objects. Picture Manager provides two modes: [Project] and [Library]. Pictures in [Project] mode will be stored in .empt project file. Pictures in [Library] mode will be stored in EasyBuilder Pro libraries, or the user-defined directory.

Each Shape or Picture includes up to 256 states. This chapter explains how to build Shape Library and Picture Library.

 For more information about using libraries while creating an object, see “9 Object General Properties”.

14.2. Building Shape Library

Shapes are vector graphics constructed by lines, curves or polygons. A Shape can have more than one state, and each state includes two parts: frame and inner, as shown in the following figure.

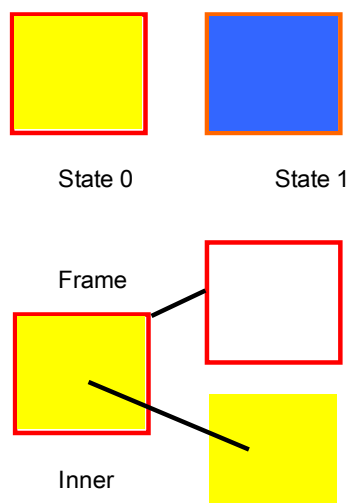



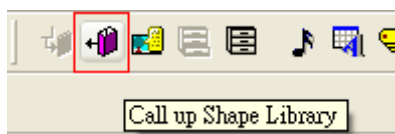

14.2.1. Shape manager

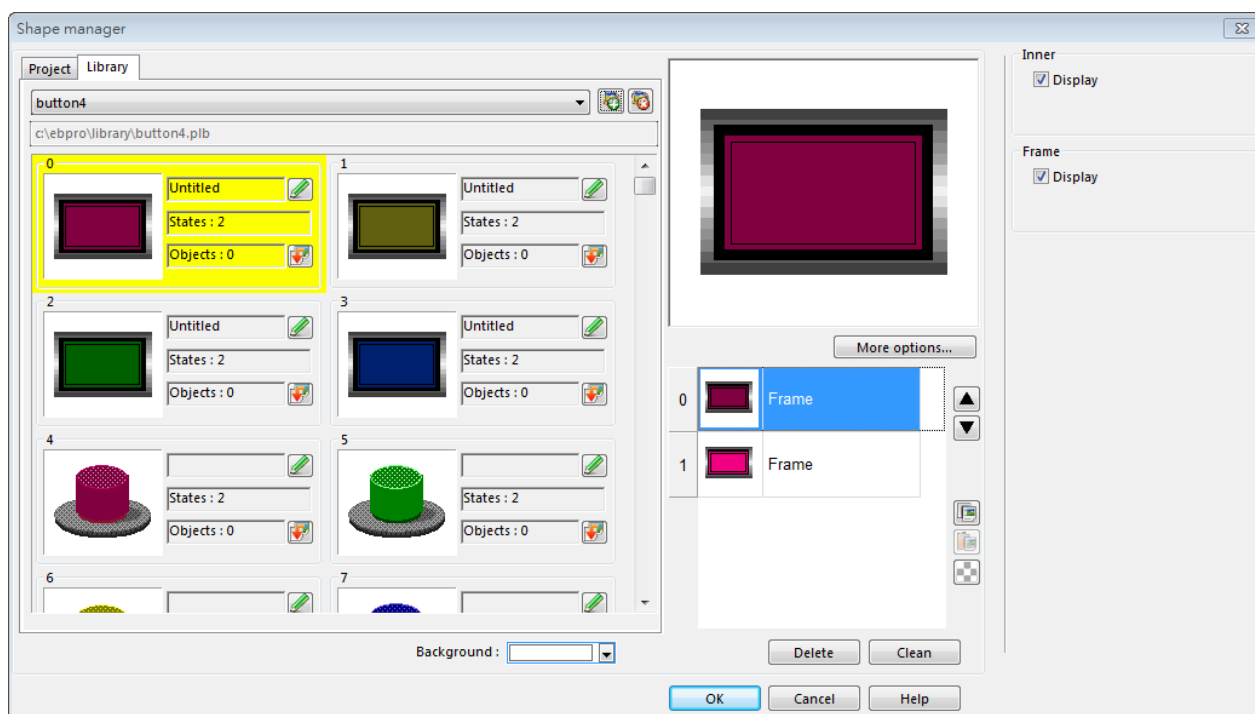
An object can use frame, inner or both. Click [Call up Shape Library], and the [Shape manager] dialog box appears.





Setting	Description
Project	The Shape edited here will be saved in .empt. Up to 1000 Shapes can be added.
Library	The Shape edited here will be saved to the library directory on PC and will not be saved to .empt project file.
 New library	Include existing .plb shape library files or create a new one. To create an empty library, enter a new file name and click [Open]. Up to 40 library files can be added.
 Unattach library	Exclude current library.
 Copy to project	Copy the selected Shape to [Project]. Only the shapes that do not belong to the System Libraries can be copied. Shapes in System Frame/System Button/System Lamp/System Pipe cannot be copied.
Background	Select and preview the background color of the Shape. The color is only displayed in [Shape manager] dialog box, and is not displayed when placing the object in the screen.
More options	Set the color and style of [Inner], [Frame], and

	[Pattern].
	Move the Shape to the previous / next state.
 Copy	Copy the selected Shape.
 Paste	Paste the copied Shape.
 Insert transparent state	Insert a blank state after the selected state.
Delete	Delete the selected state of the shape.
Clean	Delete all the states of the selected shape.
OK	Confirm to save the edited Shape.
Cancel	Cancel the editing event.
Help	Open help files.

 **Note**

- The color of [Inner] and [Frame] can be selected in Shape Library. The selection of [Pattern Style] is only available in System Frame / System Button Library.

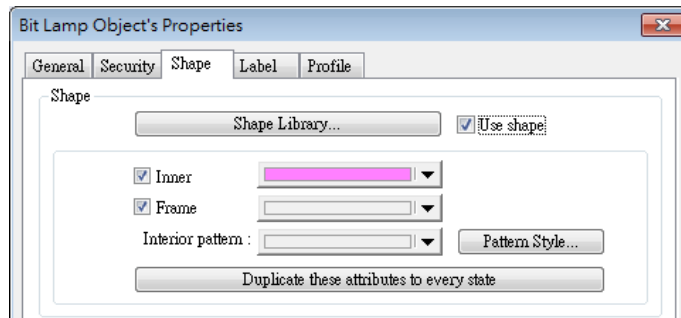

- cMT Series supports using gradient patterns in [Pattern Style], as follow:

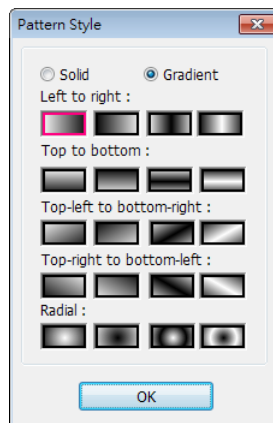

14.2.2. Steps to Build Shape Library

The following explains how to create a new Shape Library and add a Shape with two states into

the library.

1. Click [New library] and enter the name of the new Shape Library, for example, “new_lib”.

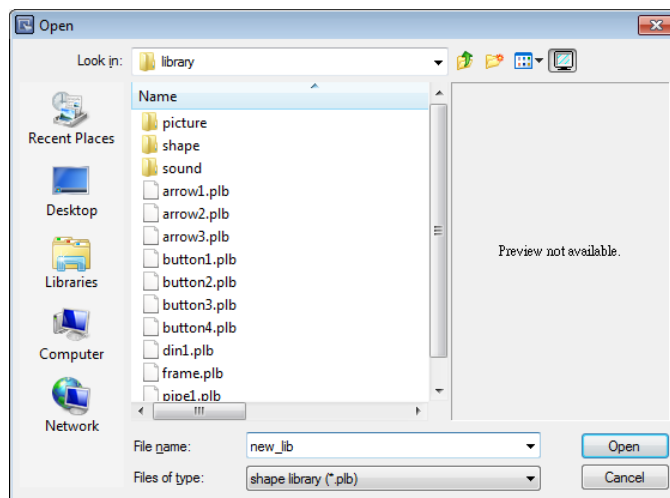

2. Click [Open], a popup dialog appears; click [Yes] to create the file.
3. A new Shape Library [new_lib] is added in [Shape manager], and its directory is shown below the name. This library is empty now as shown in the following figure.

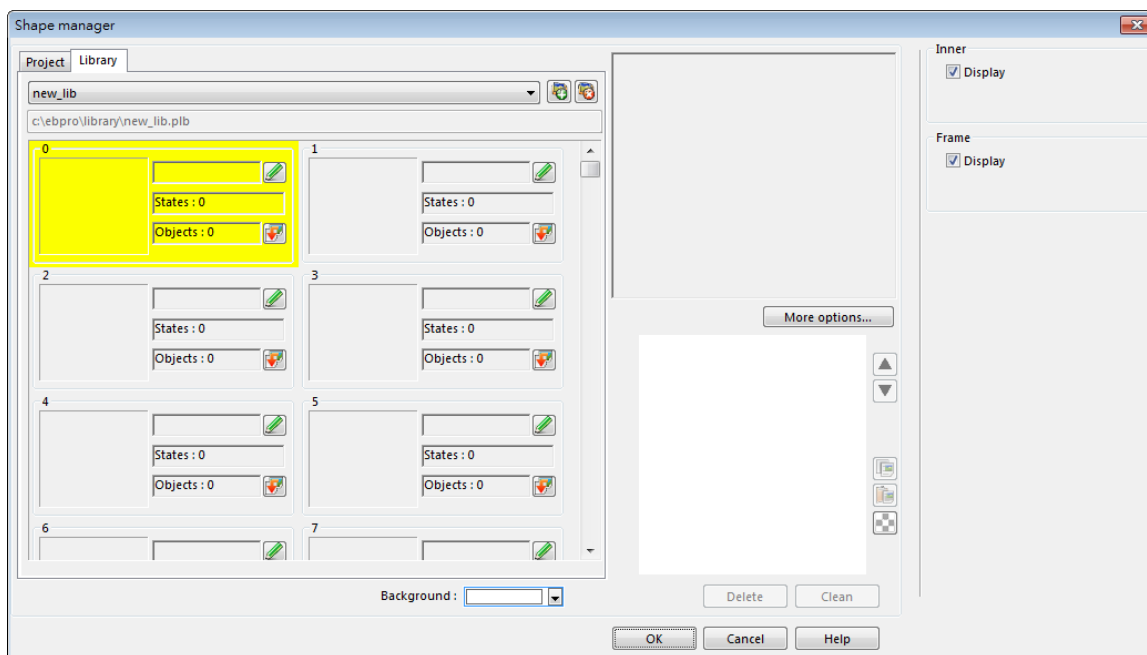

4. Add a state to the selected Shape. First, use the drawing tools to draw a frame and inner in the window and select the frame to add to the Shape Library.

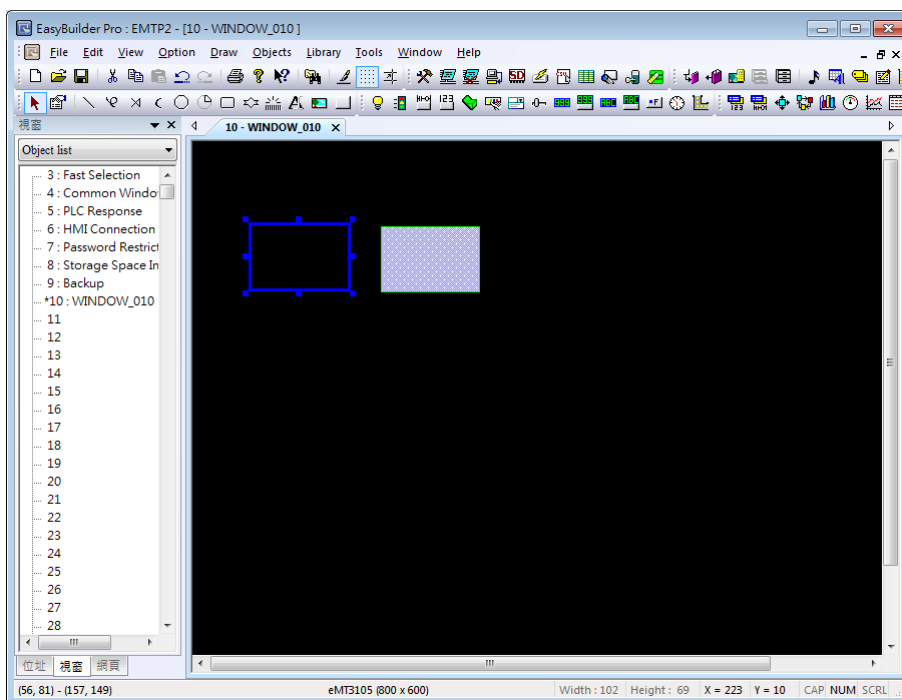

5. Click [Library] » [Shape] » [Save to Shape Library] button in the toolbar, select [new_lib], and select a number in this library. The selected number is highlighted yellow.
6. Save the Shape as [Frame], select [Insert], and click [Save].

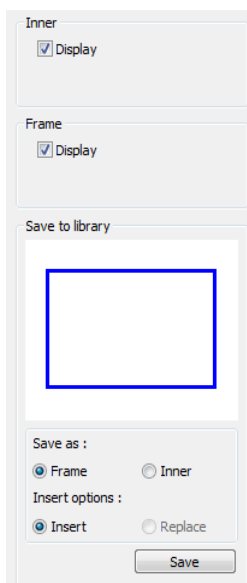

Setting	Description
Inner	Displays the inner of the Shape.
Frame	Displays the frame of the Shape.
Save to library	Save as Frame Saves the Shape as a frame.
	Save as Inner Saves the Shape as inner.

Insert

Inserts the Shape to be a new state.

Replace

Replaces a state with this Shape.

Save

Saves the settings above.

7. The following shows that a state of the Shape is added, and is defined as a frame.

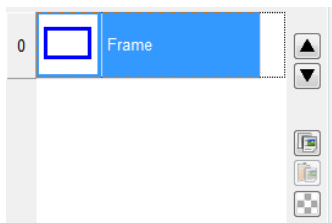

8. Create the shape to be saved as inner. Select the shape drawn in the window.

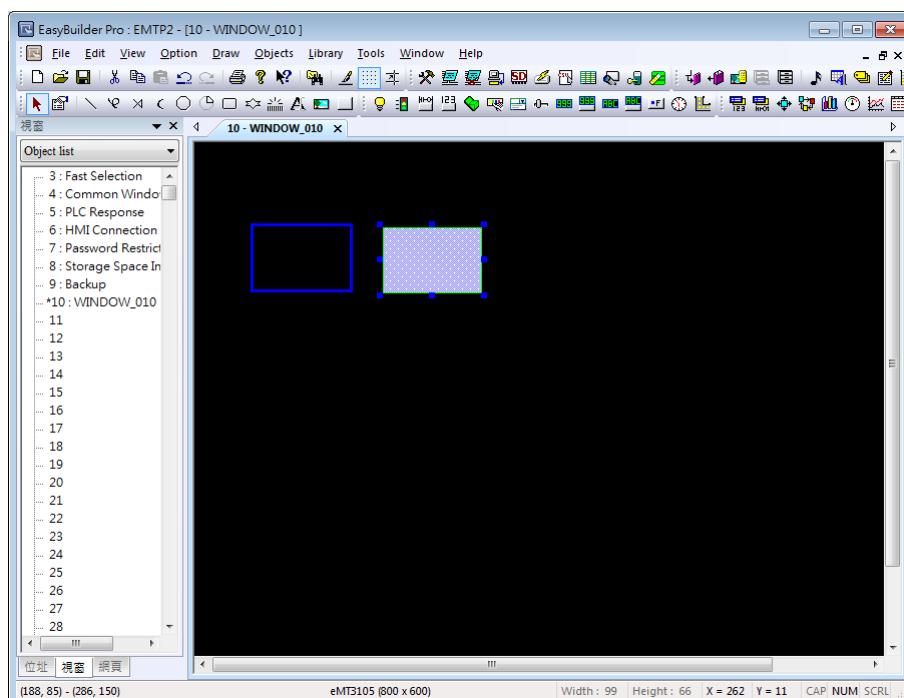

9. Click [Save to Shape Library] button in the toolbar, select [new_lib], and select the same number as in creating the frame in this library. The selected number is highlighted yellow.

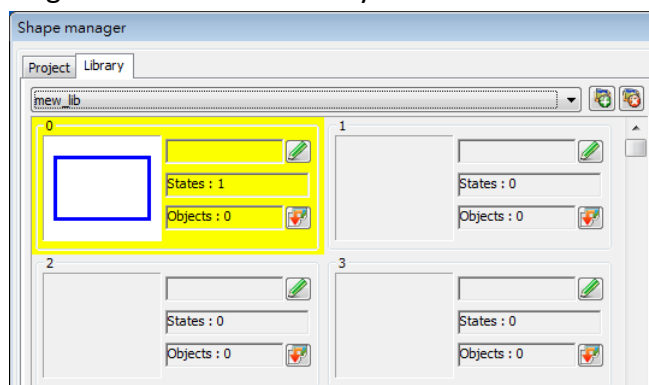

10. Save the Shape as [Inner], select [Replace], and click [Save].

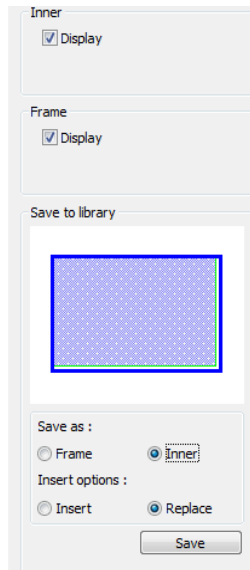

11. A state of a Shape can include [Inner], [Frame], or both. The state 0 of the Shape shown in the following figure includes both frame and inner. Click [OK], the state 0 of the Shape is created.

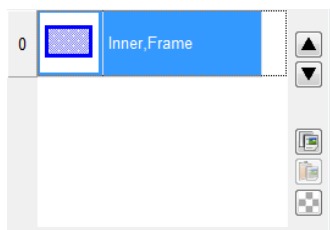

12. Follow the steps of creating state 0 and insert a new state set to state 1 as shown in the following figure. The Shape now has two states, click [OK] to finish setting.

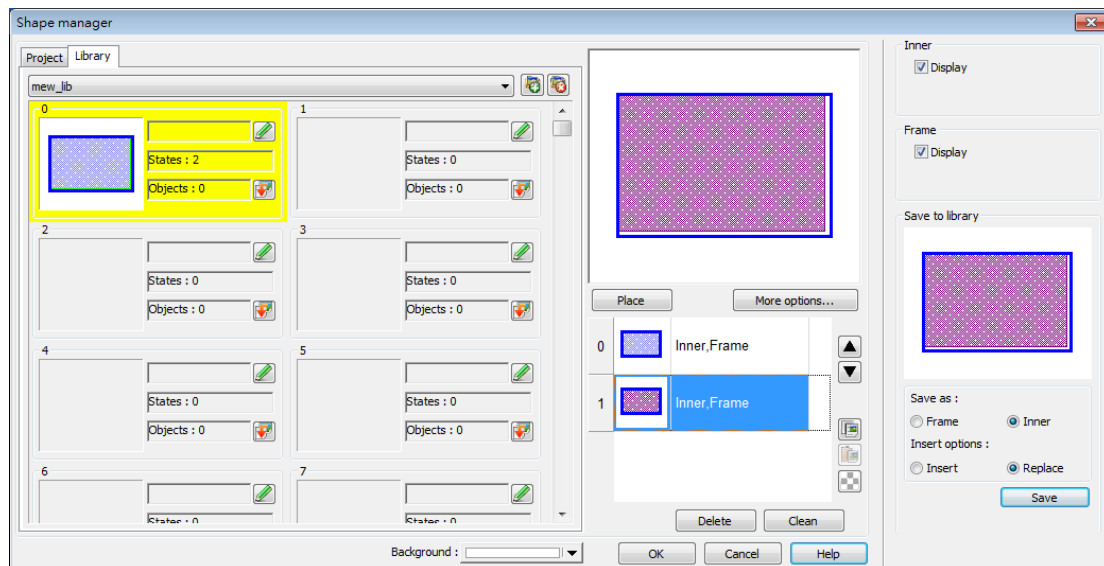





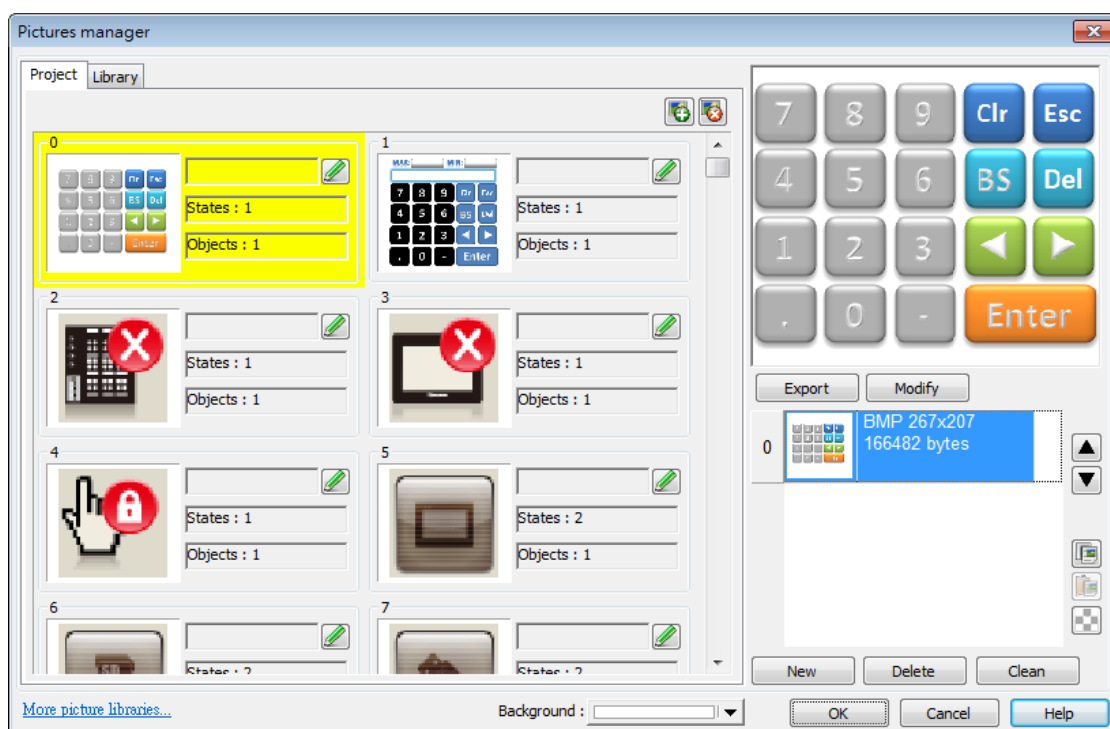
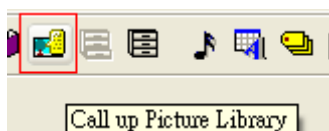

14.3. Building Picture Library

14.3.1. Picture manager

Click [Call up Picture Library] button in the toolbar and the [Picture manager] dialog box appears.



Setting	Description
Project	The Picture edited here will be saved in .empt. Up to 1000 Pictures can be added.
Library	The Picture edited here will be saved to the library directory on PC and will not be saved to .empt project file.
 New library	Add the existing .flb picture library files. To add a new library that does not exist, enter a new file name and click [Open], an empty library file is created. Up to 40 library files can be added.

 Unattach library	Delete the current library.
 Copy to project	Copy the Picture to [Project].
Background	Select the background color of the Picture. The color is only displayed in [Picture manager] dialog box, and is not displayed when placing the object in the screen.
More picture libraries	Log in to Weintek Official Website to download more libraries.
Export	Export the selected Picture.
Modify	Modify the settings of the selected Picture.
	Move the Picture to the previous / next state.
 Copy	Copy the selected Picture.
 Paste	Paste the copied Picture. The Picture copied to the clipboard can be imported to the library by pasting.
 Insert	Insert a blank state after the selected state.
transparent state	
New	Add a new Picture.
Delete	Delete the selected Picture.
Clean	Delete all the Pictures listed here.
OK	Confirm to save the edited Shape.
Cancel	Cancel the editing event.
Help	Open help files.

Note

- The supported picture formats are .bmp, .jpg, .gif, .dpd, .svg and .png. When adding a gif animation file in Picture Library, the loop times of this animated Picture can be set.

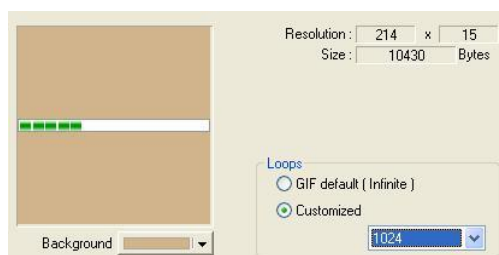

14.3.2. Steps to Build Picture Library

The following example explains how to create a new Picture Library and add a Picture with two states into the library.

1. Click [New library] and enter the name of the new Picture Library.

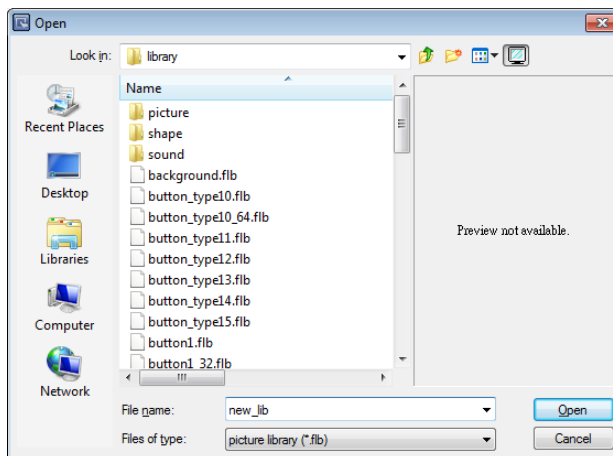

2. Click [Open], a popup dialog appears; click [Yes] to create the file.
3. A new Picture Library [new_lib] is added in [Picture manager]. This library is empty as shown in the following figure.

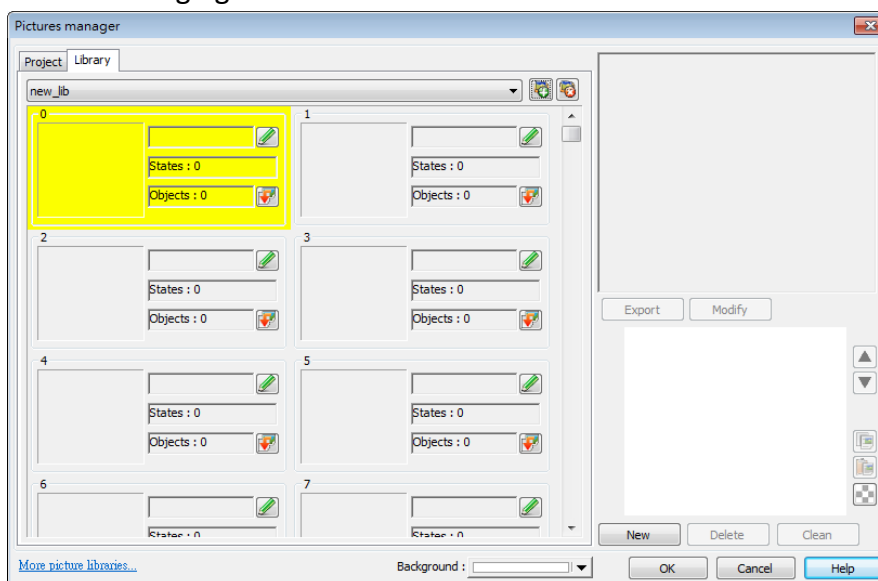

4. Draw the two pictures below to represent state 0 and state 1 respectively.

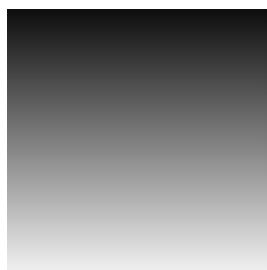

5. Select [new_lib], and select a number in this library. The selected number is highlighted yellow.

6. Click [New], and select the picture for state 0.
7. When the following dialog box is shown, select [Enable] check box to use transparent color. Set to RGB (121, 121, 121), the corresponding color in the picture below will be transparent. Or, click on a desired area with mouse to be the transparent area, the system will show the RGB of the clicked area automatically.

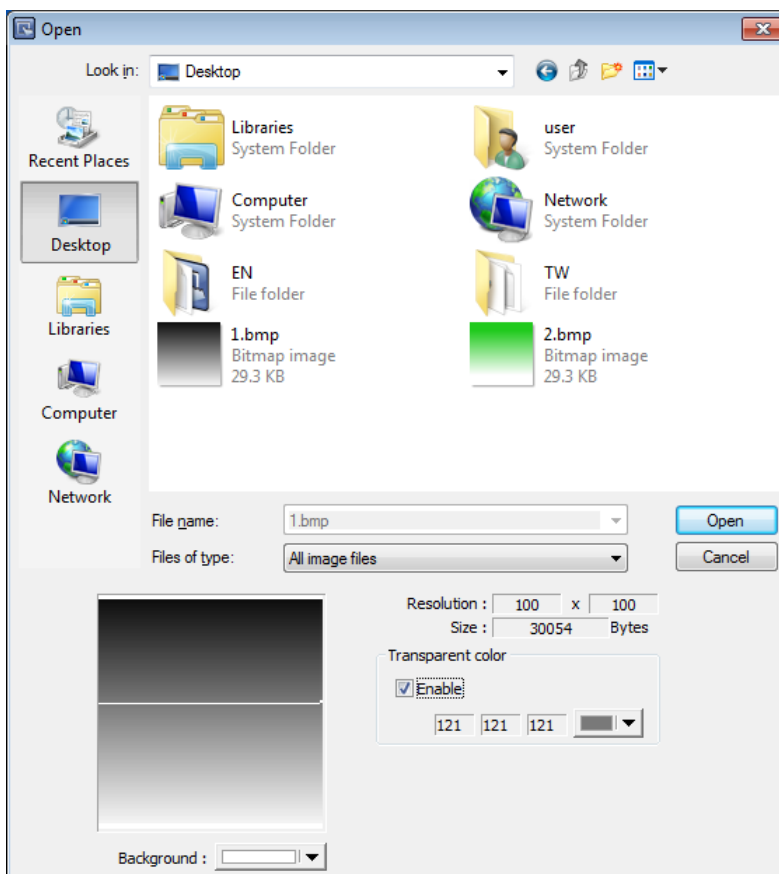

8. To set transparent color, select [Enable] check box first, and then click an area in the picture. The RGB value of that area is shown and it will be transparent. The displayed picture is shown as in the preceding figure.
9. The Picture of state 0 is created. Follow the steps of creating state 0 to create state 1 by clicking [New] as shown in the following figure.

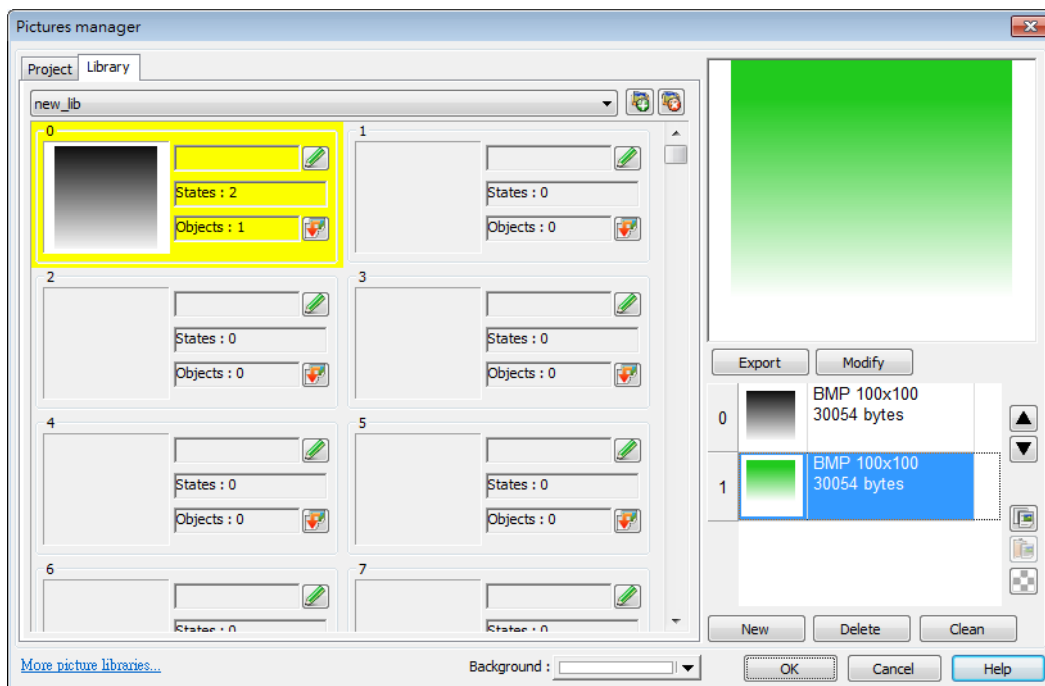

10. When finished, a complete Picture is created, click [OK]. In [Picture manager] dialog box it shows that the newly added Picture Number 0 is a bitmap picture with two states.

14.3.3. Steps to Import Picture by Pasting

The following example explains how to import a Picture into the library by pasting the picture from the clipboard.

1. Copy the following picture to the clipboard.



2. Click the Paste icon on the right side.

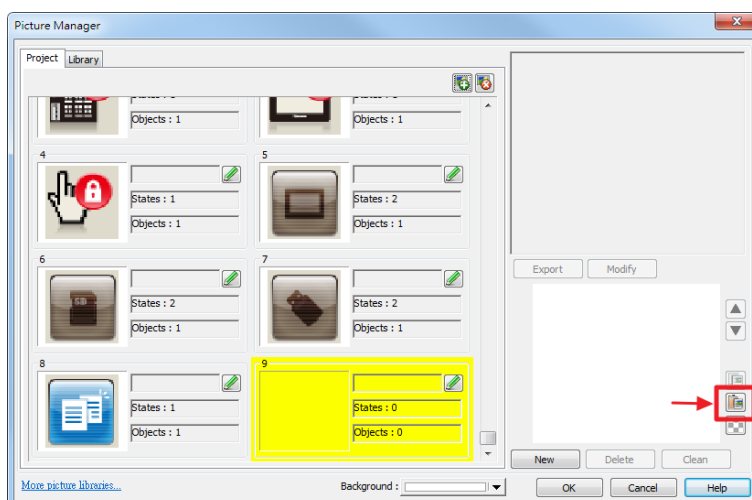

3. The Picture can be easily imported to the library.

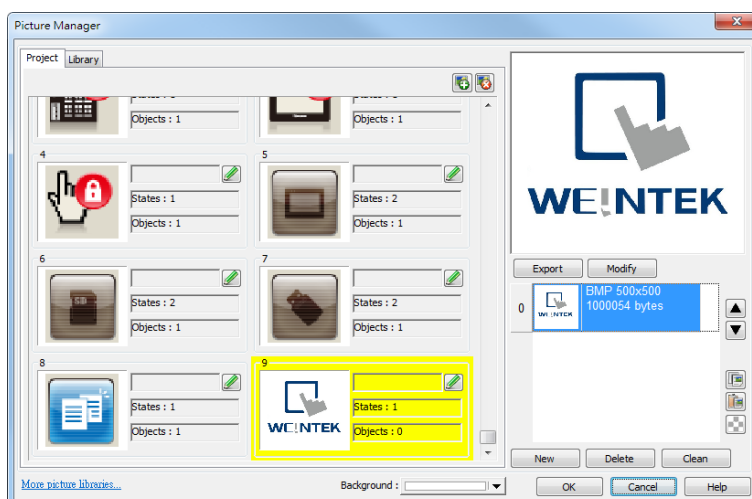

Note

- Transparent color can only be set for .bmp, .dpd, and .jpg picture files.

14.4. Immediate Modification and Preview

From EasyBuilder Pro V5.07.01, Shape Library / Picture Library settings windows are opened in the editing window. The user can immediately change the picture used by an object or multiple objects, and certain libraries support immediate color change.

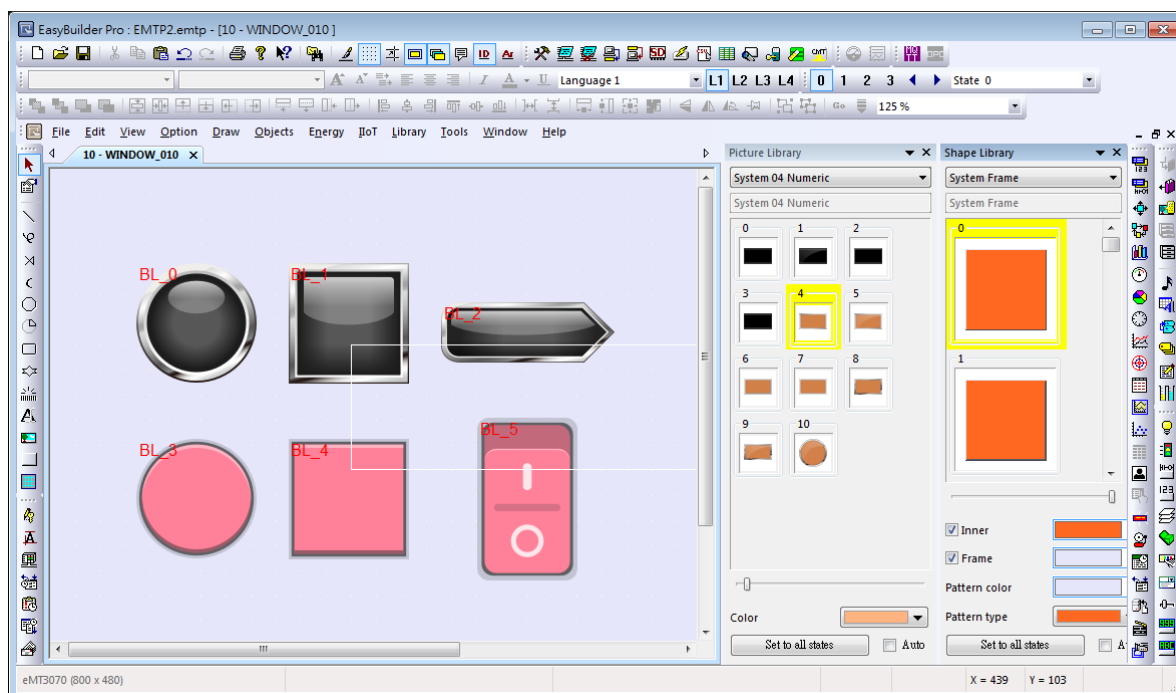

14.4.1. Replacing a Picture

1. Click the object or objects whose picture is to be replaced.
2. Locate a new picture in Picture Library window and click the lower-right corner of that picture.

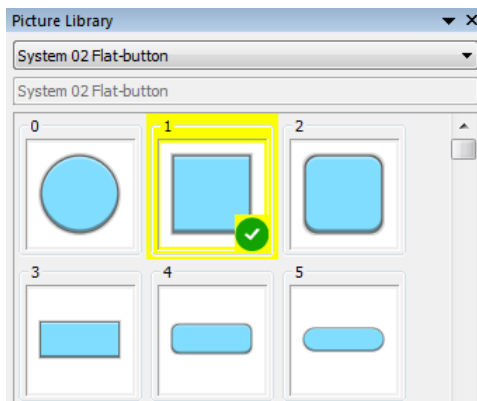

14.4.2. Replacing a Color

The [Color] drop-down list appears when the selected library supports immediate color change.

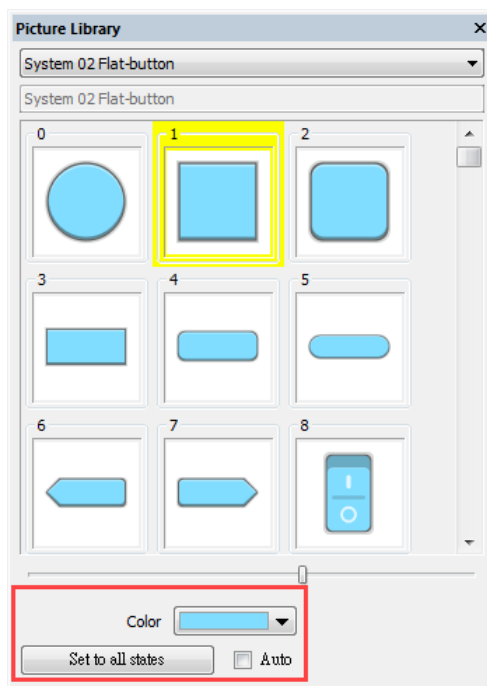

1. Select an object or objects whose color is to be replaced.
2. Select a color from the Color drop-down list.

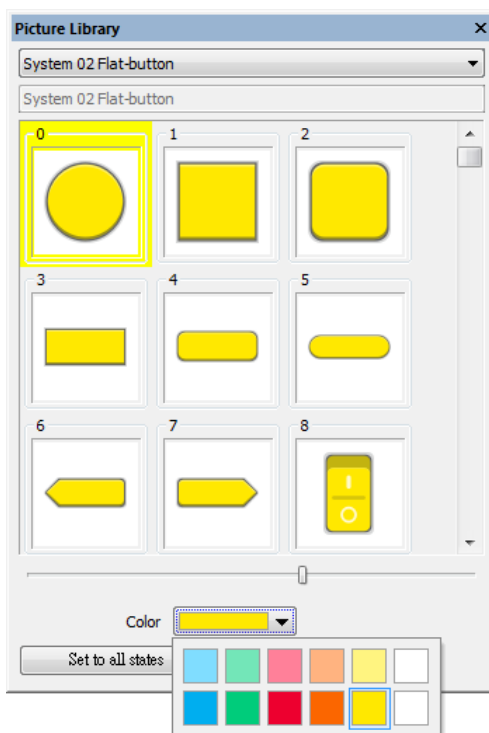

- Click the lower-right corner of the new picture to apply.

Setting	Description
Set to all states	Apply the selected color to all states of the object that use the same picture.
Auto	Automatically execute [Set to all states].

14.4.3. Extended Features

- In the settings window, dragging the slider leftward or rightward can make the thumbnail of the pictures smaller or bigger.

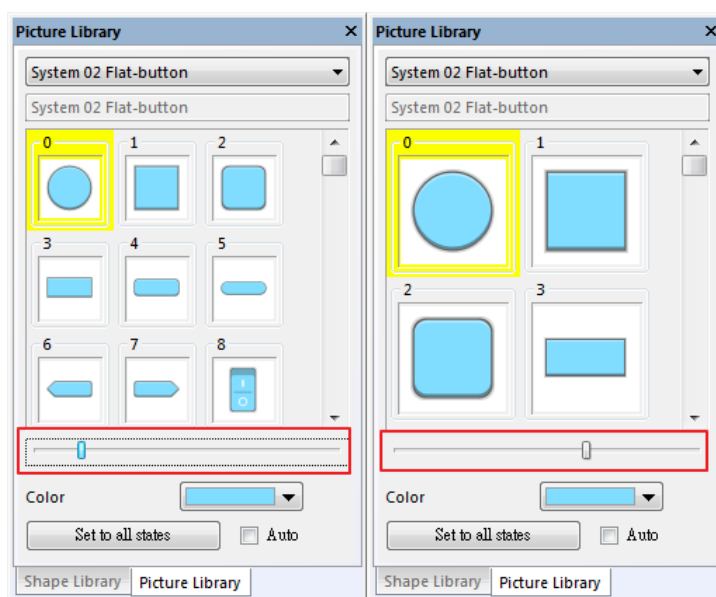

- Immediate preview can be achieved by:
 1. Select an object.
 2. Press and hold the Shift key on the keyboard.
 3. Select a picture in the library to preview, and release the Shift key to return to current picture.

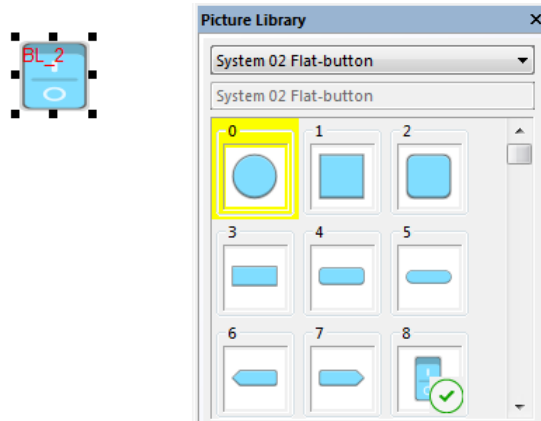

14.4.4. Docking a Window

Users can drag the window to a desired destination position. When dragging the window, a semi-transparent outline of the window shows where the window will be docked when releasing the mouse cursor at that point.

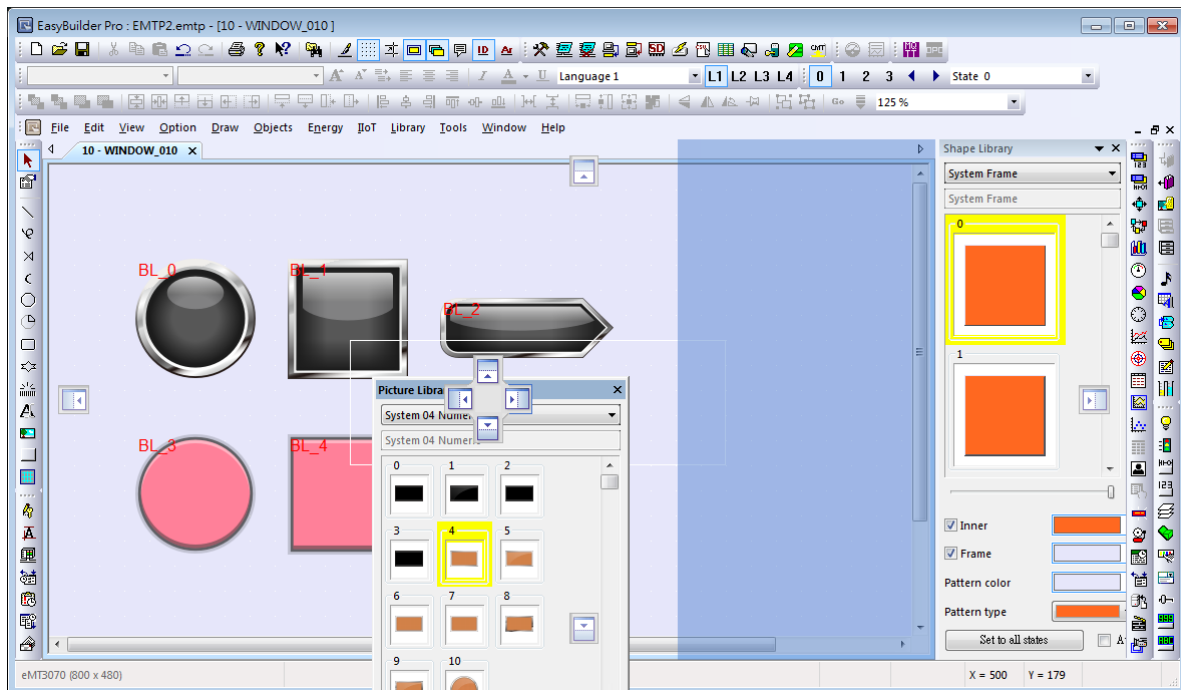

15. Label Tag Library and Multi-Language

This chapter explains how to build and use Label Tag Library.

15.1. Overview.....	15-2
15.2. Label Tag Library Manager.....	15-2
15.3. Steps to build Label Tag Library	15-3
15.4. Using Label Tag Library	15-4
15.5. Settings of Multi-Language.....	15-5

15.1. Overview

The Label Tag Library feature enables a multi-language environment. When multiple languages are required, users can create the Label Tag Library and then select a suitable label in the project. The project will display the corresponding language in runtime based on the settings. EasyBuilder Pro supports up to 24 different languages simultaneously. This chapter will explain how to create and use the Label Tag Library.

15.2. Label Tag Library Manager

Click [Library] » [Label] on the toolbar and the [Label Tag Library] dialog box appears.

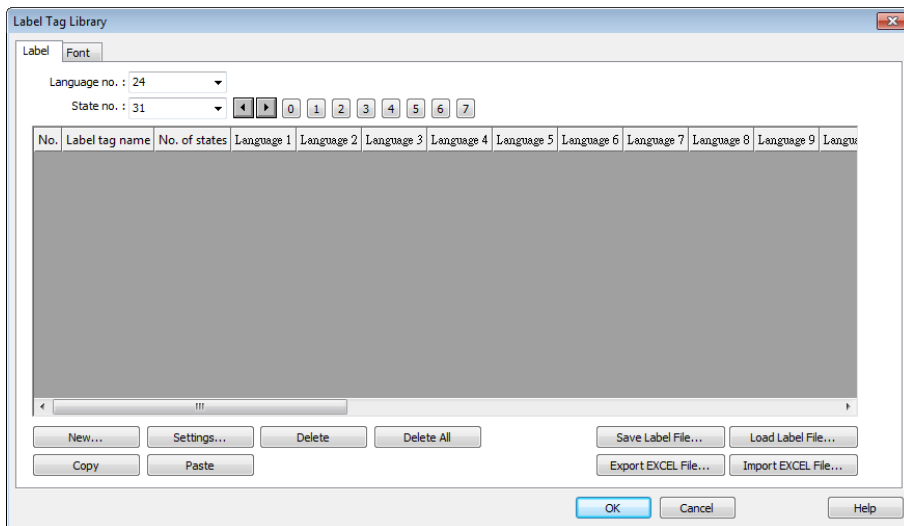

Setting	Description
Language no.	Specifies the number of languages used in a project.
State no.	Indicates the current state. Each Label has a maximum of 256 states (state no. 0 ~ 255). The state no. is determined by [Language no.]. If less than 3 languages are used, the maximum state no. is 256. If more than 4 languages are used, divide 768 by the language number to get the maximum state no.. For example, the number of languages is 24, then there are only $768/24 = 32$ states.
New	Adds a new Label.
Settings	Sets the selected Label.
Save Label File	Saves all Labels in .lbl format.
Load Label File	Loads the existing .lbl file to the Label Library.
Export EXCEL File	Saves all Labels in .csv, .xls, or .xlsx format.
Import EXCEL file	Loads the existing .csv, .xls, or .xlsx file to the Label Library.

 **Note**

- Unicode is not supported when importing and exporting an Excel file.

15.3. Steps to create Label Tag Library

Please follow the steps to create a Label Tag Library.

1. From the Library menu, click [Label]. The Label Tag Library dialog box appears. Click [New] to specify the name of the Label and the number of states to be displayed by this Label.

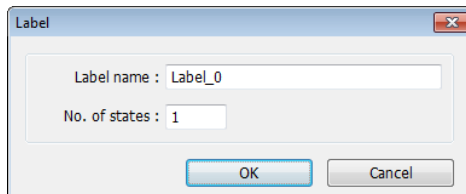

2. Click [OK] and a new label is added to the Label Tag Library. Select the label and click [Settings] to edit its content.

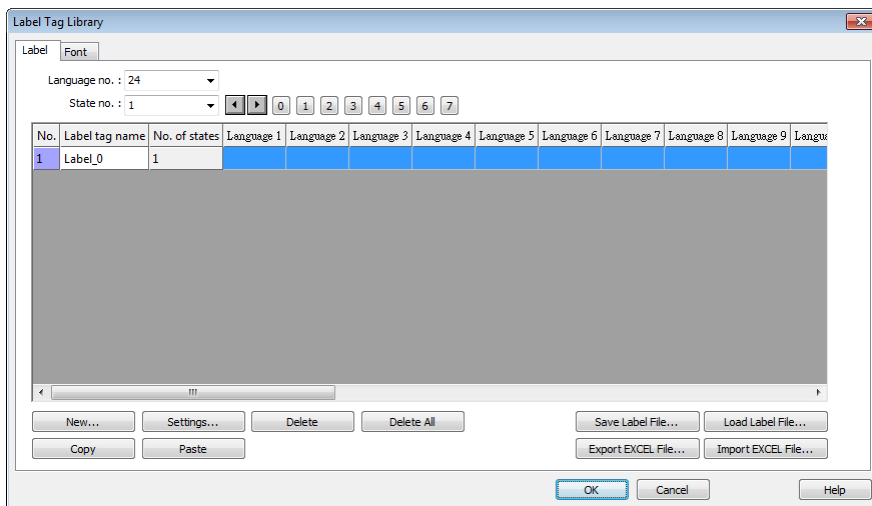

3. Edit the corresponding language content.

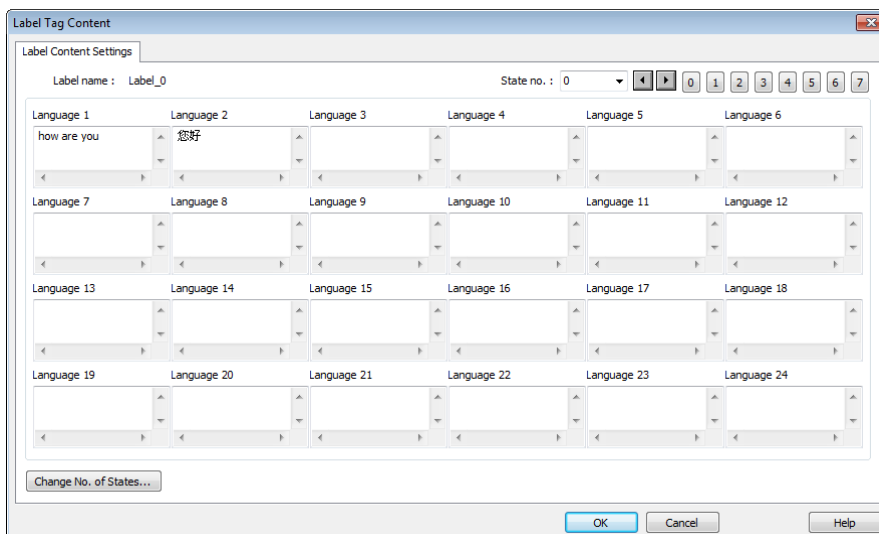

4. Select [Label Tag Library] » [Font] to view each label which contains different fonts for different languages. You can also enter the font description in the Comment field.

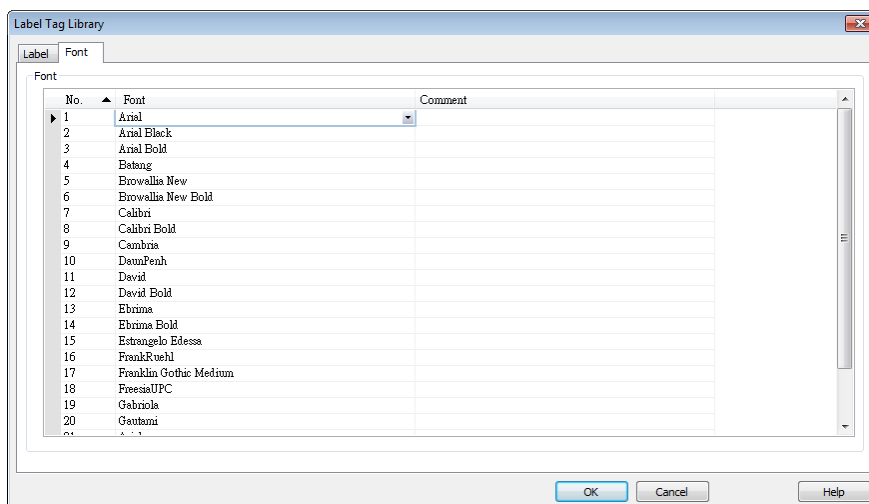

15.4. Using Label Tag Library

When there are defined labels in the Label Library, the labels can be found in the object's [Label] tab. Select [Use label library] check box, and select the label from the pull-down list [Label tag].

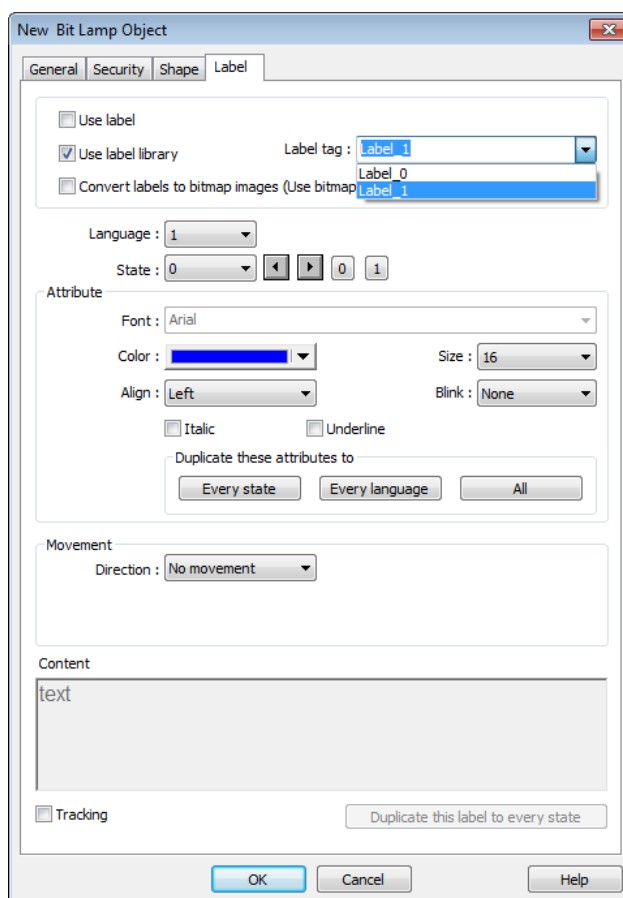

When a tag is selected, the content of the selected tag is shown in the [Content] field in its corresponding font style. Please note that from Language 2 to Language 24 can only be set the Font [Size], the others such as [Color], [Align], [Blink], etc. will follow the settings of Language 1.

15.5. Settings of Multi-Language

When displaying the texts in multiple languages, the system register “[LW-9134]: language mode” should be used too.

The value of [LW-9134] is ranged from 0 to 23 (cMT Series is from 0 to 7). Different values correspond to different languages.

If not all languages are selected to compile and download, [LW-9134] will work differently.

For example, user defines 5 different languages in the Label Library:

1: English, 2: Traditional Chinese, 3: Simplified Chinese, 4: French, 5: Korean

If only Language 1, Language 3, and Language 5 are selected to compile then the corresponding values of [LW-9134] are:

0: English, 1: Simplified Chinese, 2: Korean

Please follow the steps to use multiple languages.

1. Create a Text/Comment object and select [Use label library] checkbox.

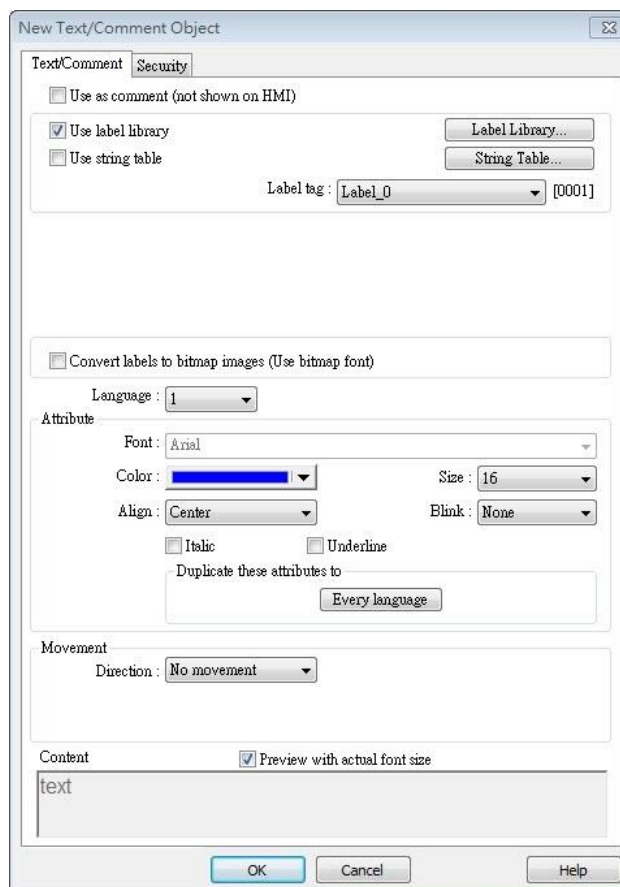

2. Create a Numeric Input Object and use the system register [LW-9134].

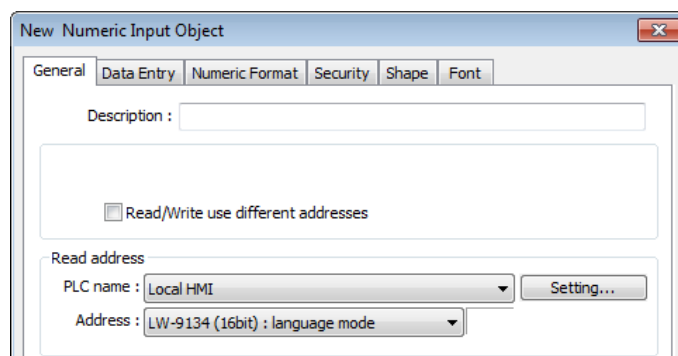

3. When compiling, select the defined languages.

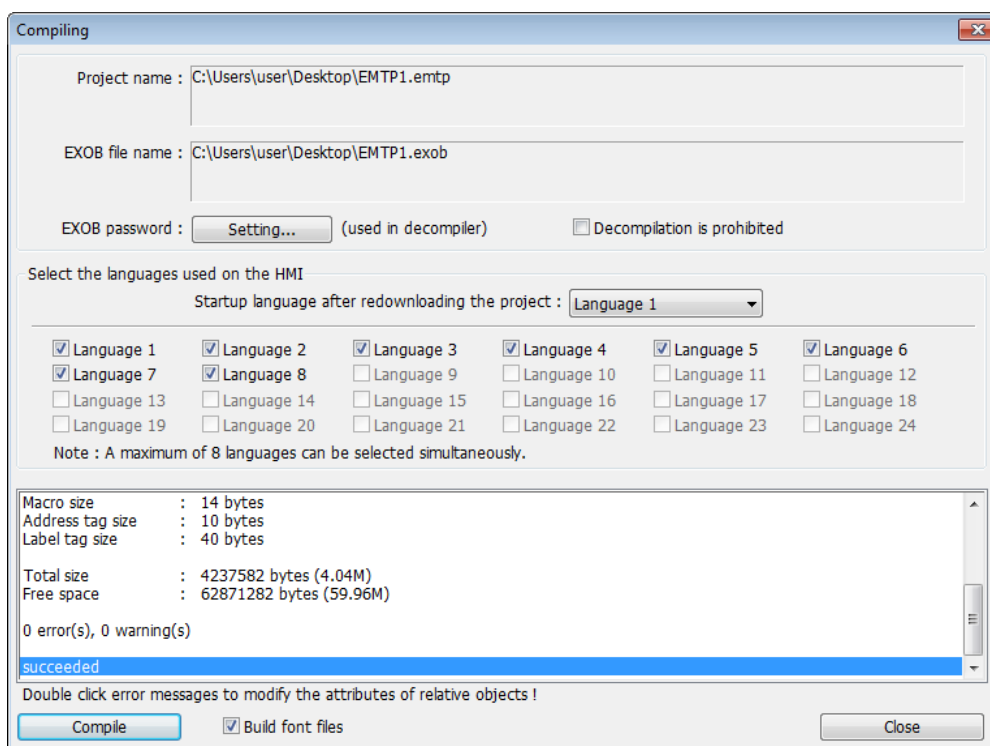

4. The simulation is shown as followed: If the value of [LW-9134] is changed, the content of the Text object will be changed.

English

LW9134 : language mode

简体中文 (SIMPLE)

LW9134 : language mode

한국어 웹 (KOREAN)

LW9134 : language mode

 **Note**

- For cMT Series, at most 8 different languages can be downloaded to the HMI.
- When selecting the HMI model: cMT, [LW-9134] is used to change the language mode on cMT model, while [PLW-9134] is to change the language mode on iPad.



Click the icon to download the demo project that illustrates how to use the Option List object to switch between multiple languages. Please confirm your internet connection before downloading the demo project.

16. Address Tag Library

This chapter explains how to build and use Address Tag Library.

16.1. Overview.....	16-2
16.2. Building Address Tag Library.....	16-2
16.3. Using Address Tag Library.....	16-4

16.1. Overview

Generally it is recommended to define the commonly used addresses in Address Tag Library when starting to build a project. It not only avoids accidental reuse of addresses but also improves project readability.

16.2. Building Address Tag Library

Click [Library] » [Tag] on the toolbar and the [Address Tag Library] dialog box appears.

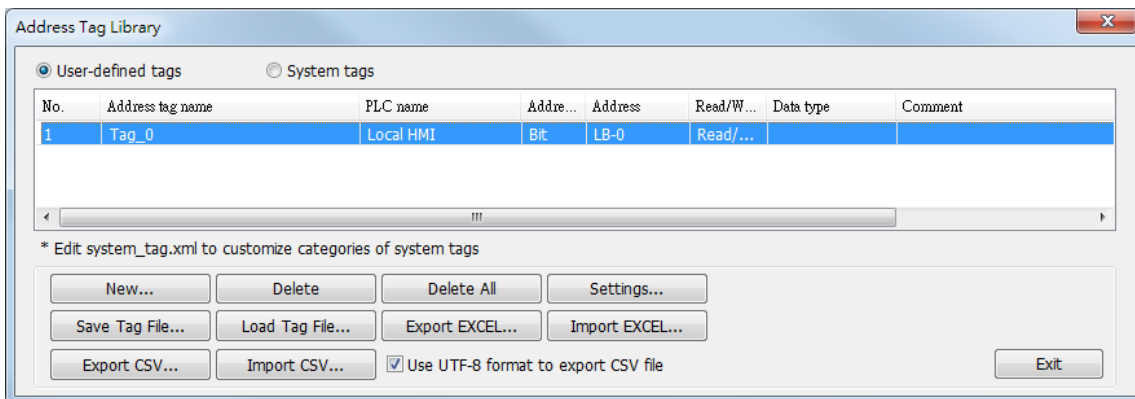

Setting	Description
Customized	Displays user-defined address tags.
System	Displays system registers. The registers listed cannot be deleted or changed.
New	Adds a new address tag. Please see the steps next page.
Settings	Sets the selected address tag.
Save Tag File	Saves all current address tags as .tgl file.
Load Tag File	Loads the existing .tgl file of address tag to the current project.
Export CSV	Saves all current address tags as .csv file.
Import CSV	Loads the existing .csv file of address tag to the current project.
Export EXCEL	Saves all current address tags as .xls file.
Import EXCEL	Loads the existing .xls file of address tag to the current project.
Use UTF-8 format to export CSV file	If selected, the .csv file will be exported in UTF-8 format. If not selected, in ANSI format.

1. Click [New] and set the relevant properties.

Setting	Description
Comment	The information of the address tag.
Tag name	The name of the address tag.
PLC name	As defined in [System Parameter Settings] » [Device list].
Address type	The tag address type; select [Bit] or [Word].
Device type	The available device types depend on [PLC name] and [Address type].
Address	Address of the tag.
Data format	If select [Word] in [Address type], the data format can be specified.
Conversion (Use Macro)	When enabled, the data format that the address tag will be converted into can be specified. Macro subroutines can be selected to do read/write conversion.
Read / Write conversion	Select the macro subroutine to do read/write conversion. The macro subroutine can only be selected when the data format is identical to the one in the macro subroutine.

- Click [OK], a newly added tag can be found in the [User-defined tags] library.

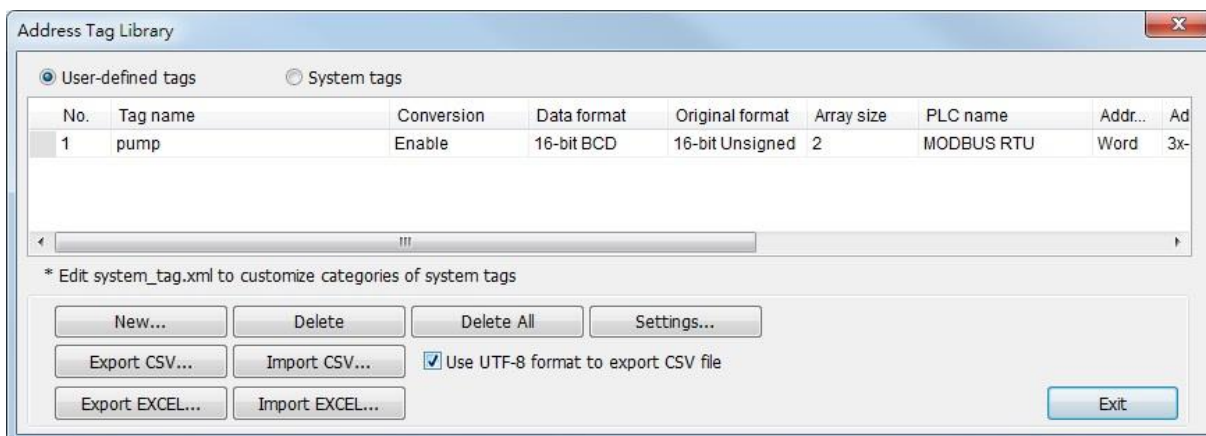

16.3. Using Address Tag Library

- Create a tag in Address Tag Library.
- Create an object, select [General] » [PLC name].
- Click [Setting] to finish the settings.
- Select [User-defined tag] check box.

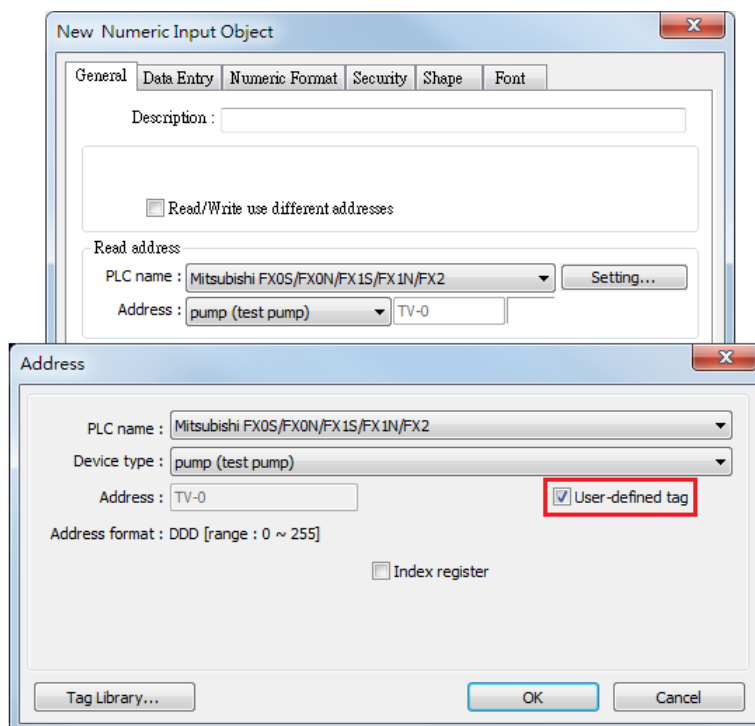

- In [Device type] select the defined tag.
- If [Data type] is selected when creating the address tag, the system automatically restricts the data format to the one selected.

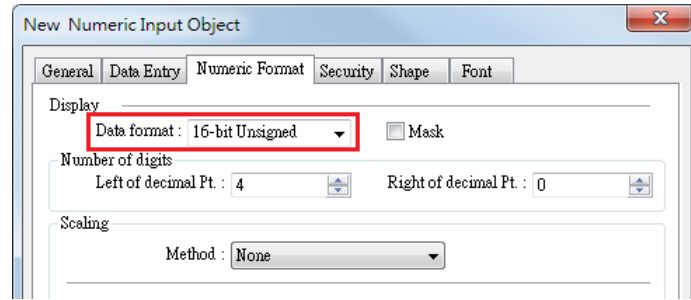

7. When finished, the window tree will show the address tag name used by the object.

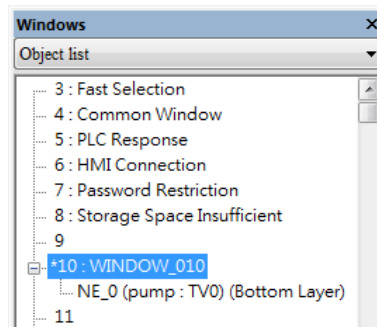

17. Transferring Recipe Data

This chapter explains how to transfer recipe data.

17.1. Overview.....	17-2
17.2. Steps to Update Recipe Data with Ethernet or USB Cable	17-2
17.3. Steps to Update Recipe Data with SD Card or USB Disk.....	17-3
17.4. Transferring Recipe Data.....	17-3
17.5. Saving Recipe Data Automatically	17-4

17.1. Overview

Recipe Data refers to the data stored in RW and RW_A addresses. The way of reading and writing these addresses is the same as operating a word register. The difference is that recipe data is stored in flash memory, when restarting HMI, the latest data records in RW and RW_A are kept.

The size of recipe data a RW address can store is 512K words, and RW_A is 64K words. Users can update recipe data with SD card, USB disk, USB cable or Ethernet and use the data to update PLC data. Recipe Data can also be uploaded to PC; furthermore, PLC data can be saved in recipe data. The following explains the ways of transferring recipe data.

17.2. Steps to Update Recipe Data with Ethernet or USB Cable

1. Open Utility Manager and click [Download].
2. Select [RW] and [RW_A] and [Browse] the source file.
3. After downloading, restart HMI, RW and RW_A will be updated.

When [Reboot HMI after download] is selected, users don't have to manually reboot HMI.

When [Reset recipe] check box is selected, the system will clear all the data in [RW] and [RW_A] before downloading.

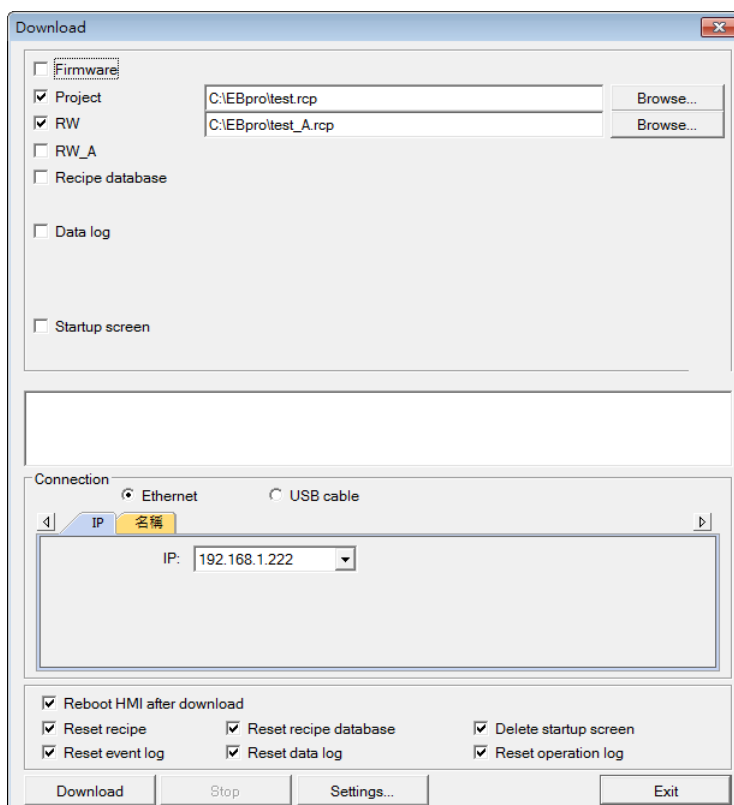

17.3. Steps to Update Recipe Data with SD Card or USB Disk

1. Open Utility Manager and click [Build Download Data for SD Card or USB Disk].
2. Insert a SD card or USB disk into PC.
3. Click [Browse] to designate the file path.
4. Click [Build], EasyBuilder Pro will save the data in SD card or USB disk.

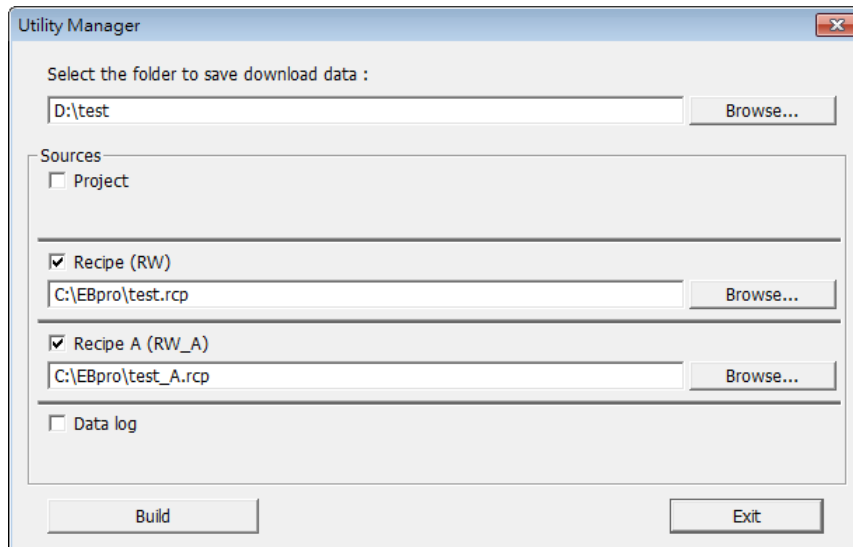

Note

- When download data is successfully built, two folders can be found: *history* and *emt3000*. *emt3000* is for storing project file; *history* is for storing recipe data and data sampling / event log records.

17.4. Transferring Recipe Data

Use [Data Transfer (Trigger-based) Object] to transfer recipe data to a specific address, or save the data of this address in [RW] and [RW_A].

Setting	Description
Source address	Sets the source of the data.
Destination address	Sets the destination of the data to transfer to.
Attribute	Sets the number of words to transfer from source to destination.

17.5. Saving Recipe Data Automatically

In order to prolong the life span of HMI flash memory, the system will automatically save the recipe data to HMI every minute. To avoid losing data when turning HMI off during the interval of saving data, system register [LB-9029: Save all recipe data to machine (set ON)] is provided. Set ON LB-9029 will make the system save recipe data once. Set ON [LB-9028: Reset all recipe data (set ON)], the system will clear all recipe data.

18. Macro Reference

This chapter describes the syntax, programming methods and usage of macro commands.

18.1. Overview.....	18-2
18.2. Instructions to use the Macro Editor.....	18-2
18.3. Configuration.....	18-7
18.4. Syntax.....	18-8
18.5. Statement.....	18-14
18.6. Function Blocks.....	18-19
18.7. Built-In Function Block.....	18-22
18.8. How to Create and Execute a Macro.....	18-85
18.9. User Defined Macro Function.....	18-89
18.10. Some Notes about Using the Macro.....	18-102
18.11. Use the Free Protocol to Control a Device.....	18-102
18.12. Compiler Error Message.....	18-107
18.13. Sample Macro Code.....	18-113
18.14. Macro TRACE Function.....	18-118
18.15. Example of String Operation Functions.....	18-122
18.16. Macro Password Protection.....	18-130

18.1. Overview

Macros provide the additional functionality your application may need. Macros are automated sequences of commands that are executed at run-time. Macros allow you to perform tasks such as complex scaling operations, string handling, and user interactions with your projects. This chapter describes syntax, usage, and programming methods of macro commands.

18.2. Instructions to use the Macro Editor

Macro editor provides the following functions:

- Display line number
- Undo / Redo
- Cut / Copy / Paste
- Select All
- Toggle Bookmark / Previous Bookmark / Next Bookmark / Clear All Bookmarks
- Toggle All Outlining
- Security -> Use execution condition
- Periodical execution
- Execute one time when HMI starts

The instructions in the following part show you how to use these functions.

1. Open the macro editor; you'll see the line numbers displayed on the left-hand side of the edit area.

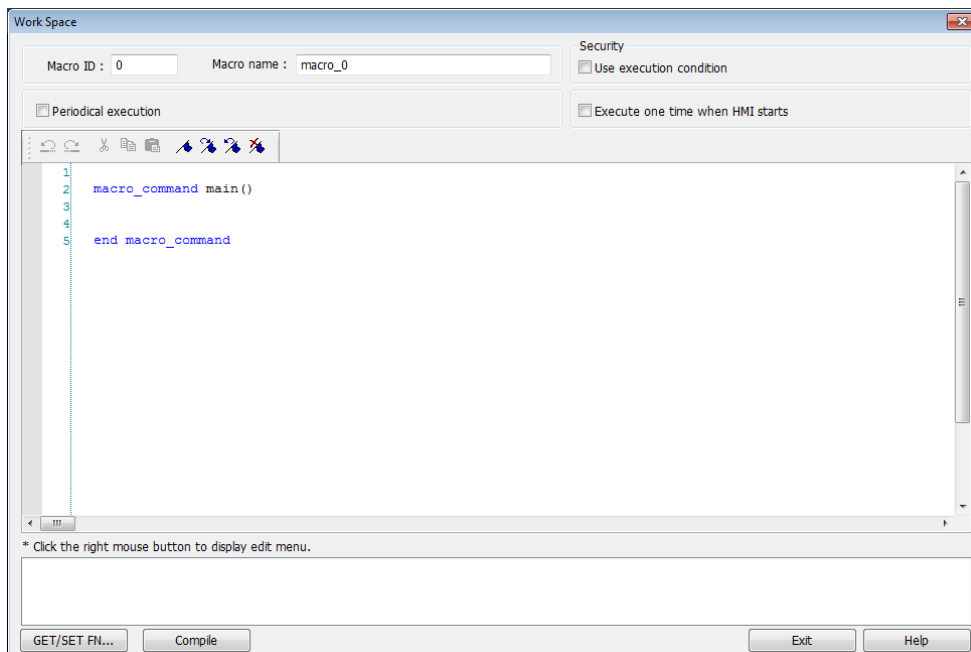

- Right click on the edit area to open the pop-up menu as shown in the following figure. Disabled operations are colored grey, which indicates that it is not possible to use that function in the current status of the editor. For example, you should select some text to enable the copy function, otherwise it will be disabled. Keyboard shortcuts are also shown.

U <u>ndo</u>	Ctrl+Z
R <u>e</u> do	Ctrl+Y
C <u>u</u> t	Ctrl+X
C <u>o</u> py	Ctrl+C
P <u>a</u> ste	Ctrl+V
S <u>e</u> lect <u>A</u> ll	Ctrl+A
T <u>o</u> ggle B <u>o</u> okmark	Ctrl+F2
N <u>e</u> xt B <u>o</u> okmark	F2
P <u>r</u> evious B <u>o</u> okmark	Shift+F2
C <u>l</u> ear <u>A</u> ll B <u>o</u> okmarks	
T <u>o</u> ggle <u>A</u> ll <u>O</u> utlining	
U <u>p</u> date <u>A</u> ll <u>O</u> utlining	

- The toolbar provides [Undo], [Redo], [Cut], [Copy], [Paste], [Toggle Bookmark], [Next Bookmark], [Previous Bookmark] and [Clear All Bookmarks] buttons.



- Any modification will enable the [Undo] function. [Redo] function will be enabled after the undo action is used. To perform the undo/redo, right click to select the item or use the keyboard shortcuts. (Undo: Ctrl+Z, Redo: Ctrl+Y).

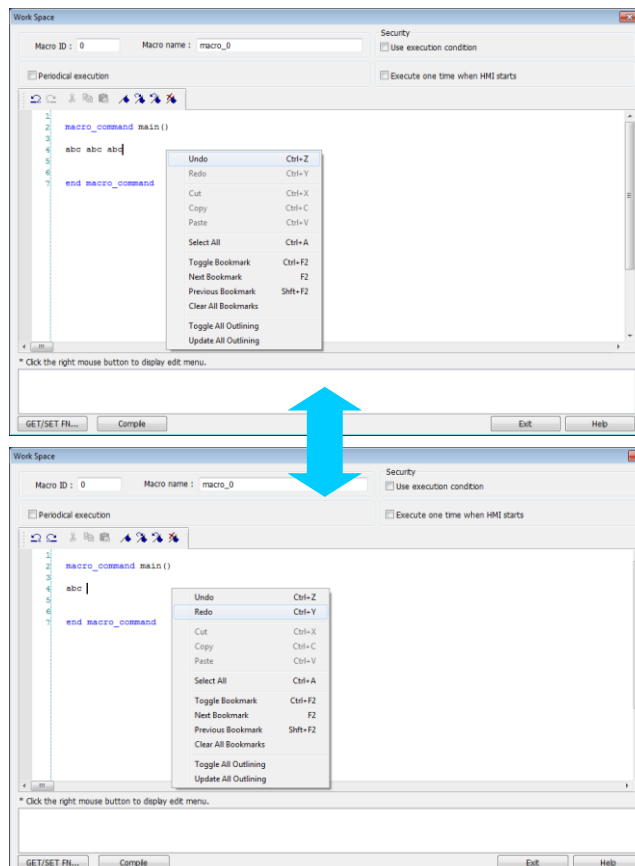

5. Select a word in the editor to enable the [Cut] and [Copy] function. After [Cut] or [Copy] is performed, [Paste] function is enabled.

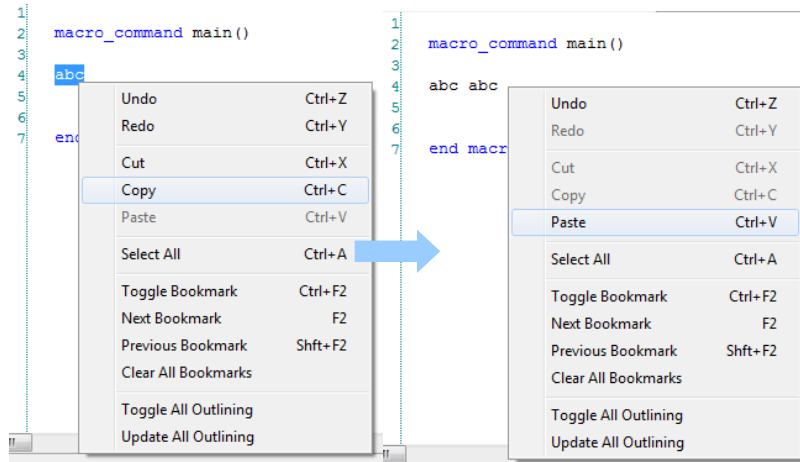

6. Use [Select All] to include all the content in the edit area.

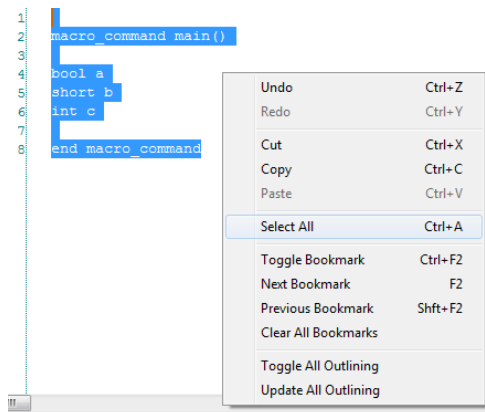

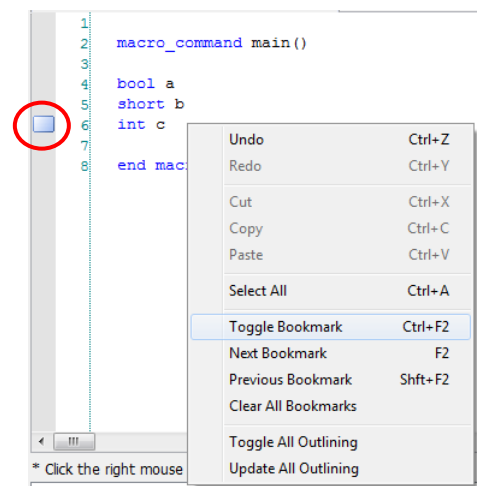

7. If the macro is too long, use bookmarks to manage and read the code with ease. The following illustration shows how it works.
 - Move your cursor to the position in the edit area where to insert a bookmark. Right click, select [Toggle Bookmark]. There will be a blue little square that represents a bookmark on the left hand side of edit area.

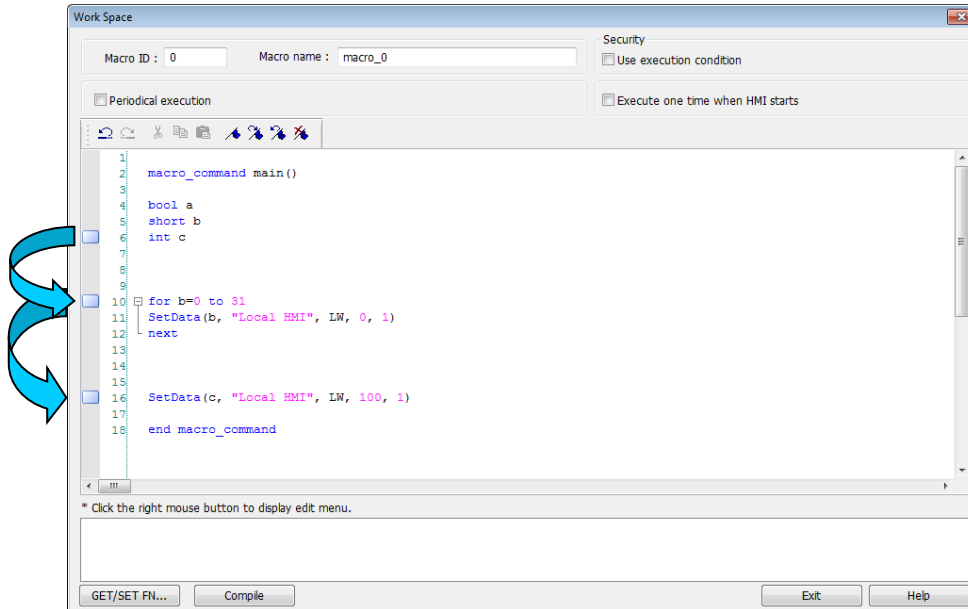

- If there is already a bookmark where the cursor is placed, select [Toggle Bookmark] to close it, otherwise to open it.
- Right click and select [Next Bookmark], the cursor will move to where the next bookmark locates. Selecting [Previous Bookmark] will move the cursor to the previous bookmark.



- Selecting [Clear All Bookmarks] will delete all bookmarks.
8. Macro editor provides outlining (or code-folding). Outlining will hide macro codes that belong to the same block, and display them as . There will be a tree diagram on the left hand side of edit area. Click  to hide the block or  to open, as shown in the following figure.

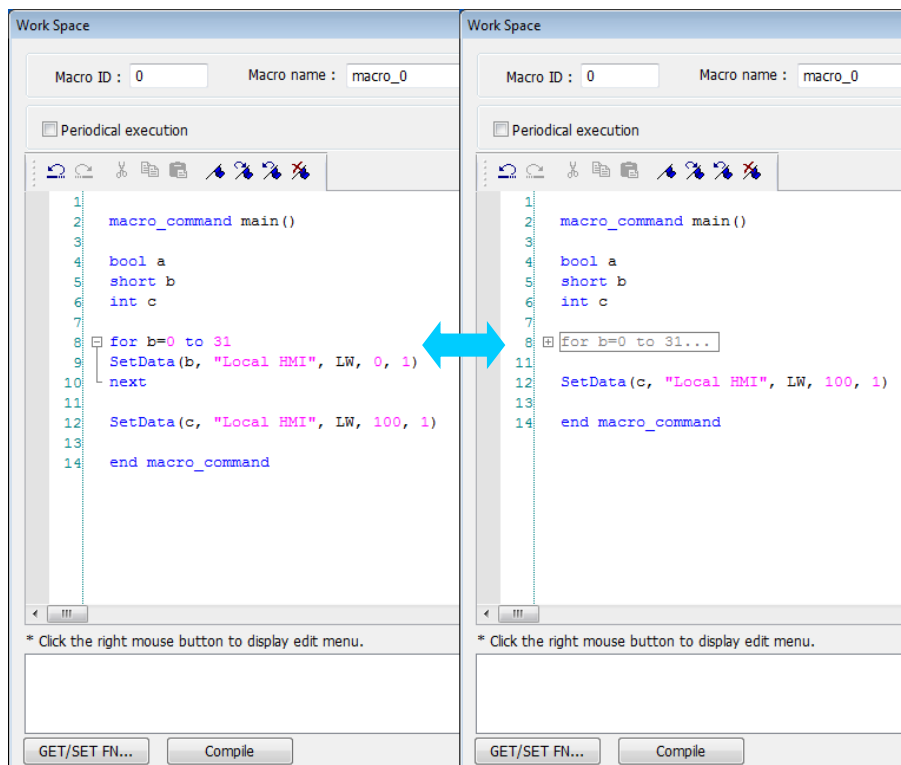

9. Right click to select [Toggle All Outlining] to open all folded macro code blocks.

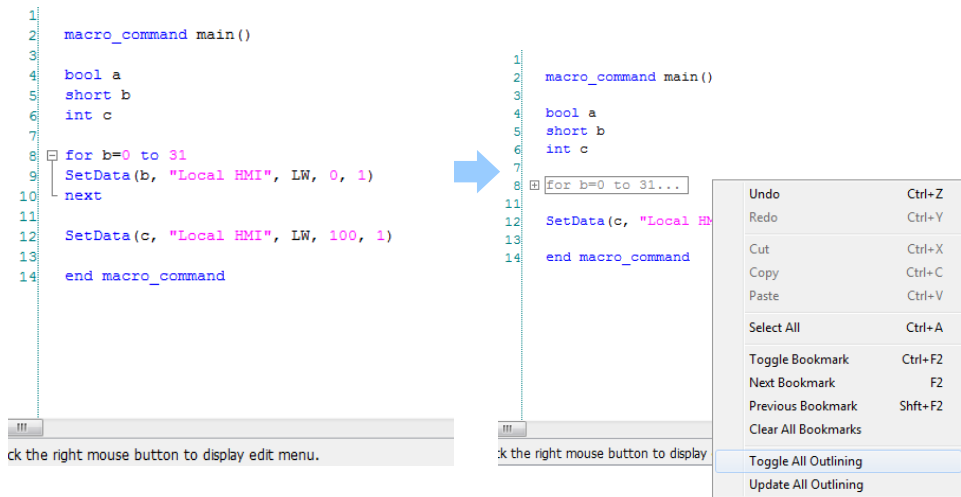

10. Sometimes the outlining might be incorrect since that the keywords are misjudged as shown in the following figure. To solve this problem, right click and select [Update All Outlining].

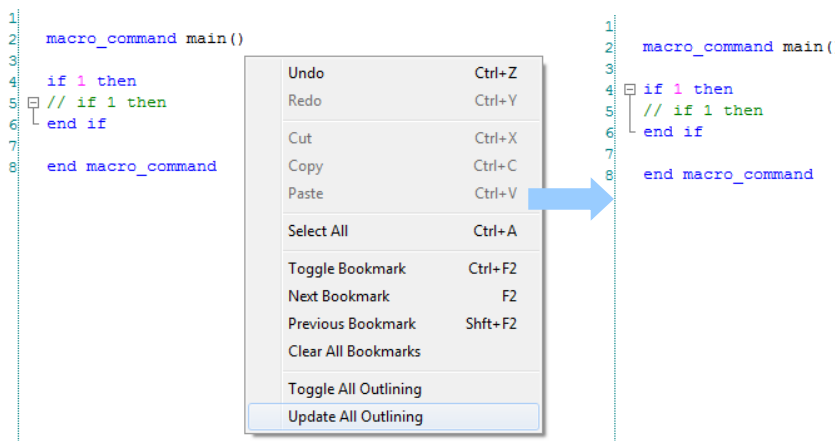

11. The statements enclosed in the following keywords are called a “block” of the macro code:

- Function block: sub – end sub
- Iterative statements:
 - i. for – next
 - ii. while – wend
- Logical statements:
 - i. if – end if
- Selective statements: select case – end select

12. The macro editor is not a monopoly window. Returning to the main screen and editing the project with the Work Space window open is allowed.

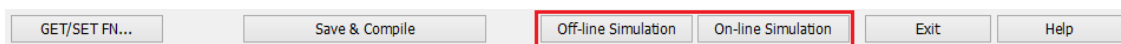

13. The macro editor provides Find and Replace features.

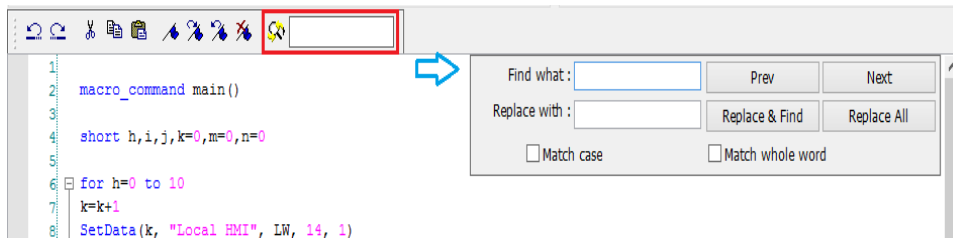

14. When [Periodical execution] is checked, this macro will be triggered periodically.

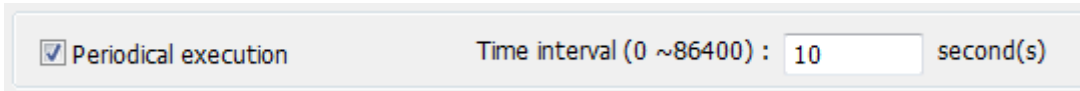

15. Select [Security] » [Use execution condition] » [Settings] to enable security settings:

- [Disable when Bit is ON]: When Bit is ON, this macro is disabled.
- [Disable when Bit is OFF]: When Bit is OFF, this macro is disabled.

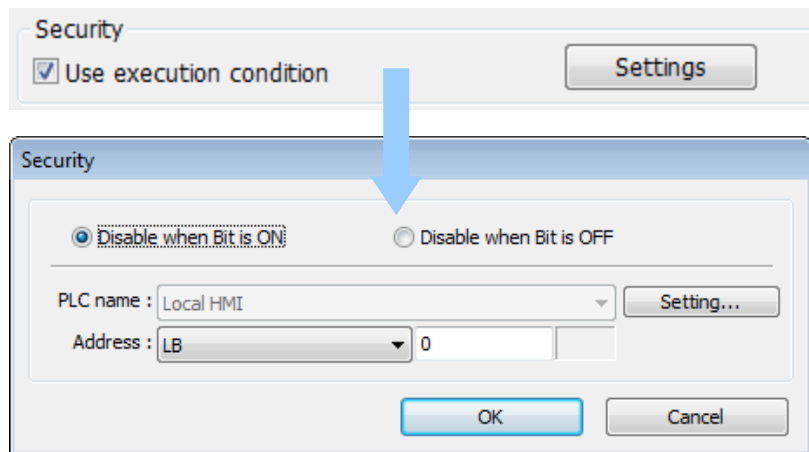

16. Select [Execute one time when HMI starts], this macro will be executed once when HMI starts up.

18.3. Configuration

A macro contains statements. The statements contain constants, variables and operations. The statements are put in a specific order to create the desired output.

A macro has the following structure:

Global Variable Declaration	-----	Optional
Sub Function Block Declarations	-----	Optional
Local Variable Declarations		
End Sub		
macro_command main()	-----	Required
Local Variable Declarations		
[Statements]		
end macro_command	-----	Required

Macro must have one and only one main function which is the execution start point of macro.

The format is:

```
macro_command main()
```

```
end macro_command
```

Local variables are used within the main macro function or in a defined function block. Its value remains valid only within the specific block.

Global variables are declared before any function blocks and are valid for all functions in the macro. When local variables and global variables have the same declaration of name, only the local variables are valid.

The following example shows a simple macro which includes a variable declaration and a function call.

```
macro_command main()
    short pressure = 10                // local variable declaration
    SetData(pressure, "Allen-Bradley DF1", N7, 0, 1) // function calling
end macro_command
```

18.4. Syntax

18.4.1. Constants and Variables

18.4.1.1. Constants

Constants are fixed values and can be directly written into statements. The formats are:

Constant Type	Note	Example
Decimal integer		345, -234, 0, 23456
Hexadecimal	Must begin with 0x	0x3b, 0xffff, 0x237
ASCII	Single character must be enclosed in single quotation marks and a string (group of characters) must be enclosed by double quotation marks.	'a', "data", "name"
Boolean		true, false

Here is an example using constants:

```
macro_command main()
short A, B      // A and B are variables
A = 1234
B = 0x12        // 1234 and 0x12 are constants
end macro_command
```

18.4.1.2. Variables

Variables are names that represent information. The information can be changed as the variable is modified by statements.

Naming Rules for Variables

- A variable name must start with an alphabet.
- Variable names longer than 32 characters are not allowed.
- Reserved words cannot be used as variable names.

There are 8 different Variable types, 5 for signed data types and 3 for unsigned data types:

Variable Type	Description	Range
bool (boolean)	1 bit (discrete)	0, 1
char (character)	8 bits (byte)	+127 to -128
short (short integer)	16 bits (word)	+32767 to -32768
int (integer)	32 bits (double word)	+2147483647 to -2147483648
float (floating point)	32 bits (double word)	
unsigned char	8 bits (byte)	0 to 255
unsigned short	16 bits (word)	0 to 65535
unsigned int	32 bits (double word)	0 to 4,294,967,295

Declaring Variables

Variables must be declared before being used. To declare a variable, specify the type before the variable name.

Example:

```
int          a
short       b, switch
float       pressure
unsigned short c
```

Declaring Arrays

Macros support one-dimensional arrays (zero-based index). To declare an array of variables, specify the type and the variable name followed by the number of variables in the array enclosed in brackets “[]”. The length of an array could be 1 to 4096. (Macros only support at most 4096 variables per macro).

Example:

```
int          a[10]
short       b[20], switch[30]
float       pressure[15]
```

The minimum array index is 0 and the maximum is (array size – 1).

Example:

```
char data [100]    // array size is 100
```

In this case, the minimum of array index is 0 and maximum of array index is 99 (=100-1)

Variable and Array Initialization

There are two ways variables can be initialized:

- By statement using the assignment operator (=)

Example:

```
int a
float b[3]
a = 10
b[0] = 1
```

- During declaration

```
char a = '5', b = 9
```

The declaration of arrays is a special case. The entire array can be initialized during declaration by enclosing comma separated values inside curly brackets “{ }”.

Example:

```
float data[4] = {11, 22, 33, 44} // now data[0] is 11, data[1] is 22....
```

18.4.2. Operators

Operators are used to designate how data is manipulated and calculated.

Operator	Description	Example
=	Assignment operator	pressure = 10

Arithmetic Operators	Description	Example
+	Addition	A = B + C
-	Subtraction	A = B - C
*	Multiplication	A = B * C
/	Division	A = B / C
%	Modulo division (return remainder)	A = B % 5

By default, integer numbers (1, 2,3..etc) are considered having integer data type; therefore, when division is carried out involving two integer numbers where the result should have decimal point, the decimal part will be removed. To avoid this, add .0 (1.0, 2.0, 3.0...etc) behind the dividend or the divisor to turn it into a floating point number calculation.

Examples:

A = 3 / 2 = 1 » 3 and 2 are both integers; therefore the result is an integer.

B = 3 / 2.0 = 1.5 » 3 is an integer whereas 2.0 is a floating point number, therefore the result is a floating point number.

C = 3.0 / 2 = 1.5 » 3.0 is a floating point number whereas 2 is an integer, therefore the result is a floating point number.

Comparison Operators	Description	Example
<	Less than	if A < 10 then B = 5
<=	Less than or equal to	if A <= 10 then B = 5
>	Greater than	if A > 10 then B = 5
>=	Greater than or equal to	if A >= 10 then B = 5
==	Equal to	if A == 10 then B = 5
<>	Not equal to	if A <> 10 then B = 5

Logic Operators	Description	Example
and	Logical AND	if A < 10 and B > 5 then C = 10
or	Logical OR	if A >= 10 or B > 5 then C = 10
xor	Logical Exclusive OR	if A xor 256 then B = 5
not	Logical NOT	if not A then B = 5

Shift and bitwise operators are used to manipulate bits of signed/unsigned character and integer variables. The priority of these operators is from left to right within the statement.

Shift Operators	Description	Example
<<	Shifts the bits in a bitset to	A = B << 8

	the left a specified number of positions	
>>	Shifts the bits in a bitset to the right a specified number of positions	$A = B \gg 8$
Bitwise Operators	Description	Example
&	Bitwise AND	$A = B \& 0xf$
	Bitwise OR	$A = B C$
^	Bitwise XOR	$A = B ^ C$
~	One's complement	$A = \sim B$

Priority of All Operators

The overall priority of all operations from highest to lowest is as follows:

1. Operations within parenthesis are carried out first
2. Arithmetic operations
3. Shift and Bitwise operations
4. Comparison operations
5. Logic operations
6. Assignment

Reserved Keywords

The following keywords are reserved for system. These keywords cannot be used as variable, array, or function names.

+, -, *, /, %, >=, >, <=, <, <>, ==, and, or, xor, not, <<, >>, =, &, |, ^, ~
 exit, macro_command, for, to, down, step, next, return, bool, short, int, char, float, void, if, then, else, break, continue, set, sub, end, while, wend, true, false
 SQRT, CUBERT, LOG, LOG10, SIN, COS, TAN, COT, SEC, CSC, ASIN, ACOS, ATAN, BIN2BCD, BCD2BIN, DEC2ASCII, FLOAT2ASCII, HEX2ASCII, ASCII2DEC, ASCII2FLOAT, ASCII2HEX, FILL, RAND, DELAY, SWAPB, SWAPW, LOBYTE, HIBYTE, LOWORD, HIWORD, GETBIT, SETBITON, SETBITOFF, INVBIT, ADDSUM, XORSUM, CRC, INPORT, OUTPORT, POW, GetCnvTagArrayIndex, GetError, GetData, GetDataEx, SetData, SetDataEx, SetRTS, GetCTS, Beep, SYNC_TRIG_MACRO, ASYNC_TRIG_MACRO, TRACE, FindDataSamplingDate, FindDataSamplingIndex, FindEventLogDate, FindEventLogIndex
 StringGet, StringGetEx, StringSet, StringSetEx, StringCopy, StringMid, StringDecAsc2Bin, StringBin2DecAsc, StringDecAsc2Float, StringFloat2DecAsc, StringHexAsc2Bin, StringBin2HexAsc, StringLength, StringCat, StringCompare, StringCompareNoCase, StringFind, StringReverseFind, StringFindOneOf, StringIncluding, StringExcluding, StringToUpper,

StringToLower, StringToReverse, StringTrimLeft, StringTrimRight, StringInsert, String2Unicode

18.5. Statement

18.5.1. Definition Statement

This covers the declaration of variables and arrays. The formal construction is as follows:

```
type      name
```

This defines a variable with name as “name” and type as “type”.

Example:

```
int A      // define a variable A as an integer
```

```
type      name[constant]
```

This defines an array variable called “name” with size as “constant” and type as “type”.

Example:

```
int B[10]  // where define a variable B as a one-dimensional array of size 10
```

18.5.2. Assignment Statement

Assignment statements use the assignment operator to move data from the expression on the right side of the operator to the variable on the left side. An expression is the combination of variables, constants and operators to yield a value.

```
VariableName  Expression
```

Example

```
A = 2      where a variable A is assigned to 2
```

18.5.3. Logical Statements

Logical statements perform actions depending on the condition of a boolean expression.

The syntax is as follows:

Single-Line Format

```
If <Condition> then
  [Statements]
else
  [Statements]
end if
```

Example:

```
if a == 2 then
    b = 1
else
    b = 2
end if
```

Block Format

```
If <Condition> then
    [Statements]
else if <Condition-n> then
    [Statements]
else
    [Statements]
end if
```

Example:

```
if a == 2 then
    b = 1
else if a == 3 then
    b = 2
else
    b = 3
end if
```

Syntax description

if	Must be used to begin the statement.
<Condition>	Required. This is the controlling statement. It is FALSE when the <Condition> evaluates to 0 and TRUE when it evaluates to non-zero.
then	Must precede the statements to execute if the <Condition> evaluates to TRUE.
[Statements]	It is optional in block format but necessary in single-line format without else. The statement will be executed when the <Condition> is TRUE.
else if	Optional. The else if statement will be executed when the relative <Condition-n> is TRUE.
<Condition-n>	Optional. see <Condition>
else	Optional. The else statement will be executed when <Condition> and <Condition-n> are both FALSE.
end if	Must be used to end an if-then statement.

18.5.4. Selective Statements

The select-case construction can be used like multiple if-else statements and perform selected actions depending on the value of the given variable. When the matched value is found, all the actions below will be executed until a break statement is met. The syntax is as follows:

Format without a Default Case

```
Select Case [variable]
Case [value]
    [Statements]
    break
end Select
```

Example:

```
Select Case A
    Case 1
        b=1
    break
end Select
```

Format with a Default Case (Case else)

```
Select Case [variable]
Case [value]
    [Statements]
    break
Case else
    [Statements]
    break
end Select
```

Example:

```
Select Case A
    Case 1
        b=1
    break
    Case else
        b=0
    break
end Select
```

Multiple cases in the same block

```

Select Case [variable]
Case [value1]
    [Statements]
Case [value2]
    [Statements]
    break

end Select

```

Example:

```

Select Case A
    Case 1
        break
    Case 2
        b=2
        break
    Case 3
        b=3
        break
end Select

```

Syntax description

Select Case	Must be used to begin the statement.
[variable]	Required. The value of this variable will be compared to the value of each case.
Case else	Optional. It represents the default case. If none of the cases above are matched, the statements under default case will be executed. When a default case is absent, it will skip directly to the end of the select-case statements if there is no matched case.
break	Optional. The statements under the matched case will be executed until the break command is reached. If a break command is absent, it simply keeps on executing next statement until the end command is reached.
end Select	Indicates the end of the select-case statements.

18.5.5. Iterative Statements

Iterative statements control loops and repetitive tasks depending on condition. There are two types of iterative statements.

18.5.5.1. for-next Statements

The for-next statement runs for a fixed number of iterations. A variable is used as a counter to track the progress and test for ending conditions. Use this for fixed execution counts. The syntax is as follows:

```
for [Counter] = <StartValue> to <EndValue> [step <StepValue>]
  [Statements]
next [Counter]
```

Or

```
for [Counter] = <StartValue> to <EndValue> [step <StepValue>]
  [Statements]
next [Counter]
```

Example:

```
for a = 0 to 10 step 2
  b = a
next a
```

Syntax description

for	Must be used to begin the statement
[Counter]	Required. This is the controlling statement. The result of evaluating the variable is used as a test of comparison.
<StartValue>	Required. The initial value of [Counter]
to/down	Required. This determines if the <step> increments or decrements the <Counter>. "to" increments <Counter> by <StepValue>. "down" decrements <Counter> by <StepValue>.
<EndValue>	Required. The test point. If the <Counter> is greater than this value, the macro exits the loop.
step	Optional. Specifies that a <StepValue> other than one is to be used.
[StepValue]	Optional. The increment/decrement step of <Counter>. It can be omitted when the value is 1. If [step <StepValue>] are omitted the step value defaults to 1.
[Statements]	Optional. Statements to execute when the evaluation is TRUE. "for-next" loops may be nested.
next	Required.
[Counter]	Optional. This is used when nesting for-next loops.

18.5.5.2. while-wend Statements

The while-wend statement runs for an unknown number of iterations. A variable is used to test for ending conditions. When the condition is TRUE, the statements inside are executed repetitively until the condition becomes FALSE. The syntax is as follows.

```
while <Condition>
    [Statements]
wend
```

Example:

```
while a < 10
    a = a + 10
wend
```

Syntax description

while	Must be used to begin the statement.
continue	Required. This is the controlling statement. When it is TRUE, the loop begins execution. When it is FALSE, the loop terminates.
return [value]	Statements to execute when the evaluation is TRUE.
wend	Indicates the end of the while-end statements.

18.5.5.3. Other Control Commands

break	Used in for-next and while-wend. It skips immediately to the end of the iterative statement.
continue	Used in for-next and while-wend. It ends the current iteration of a loop and starts the next one.
return	The return command inside the main block can force the macro to stop anywhere. It skips immediately to the end of the main block.

18.6. Function Blocks

Function blocks are useful for reducing repetitive codes. It must be defined before use and supports any variable and statement type. A function block could be called by putting its name followed by parameters in parenthesis. After the function block is executed, it returns the value to the caller function where it is used as an assignment value or as a condition. A return type is not required in function definition, which means that a function block does not have to return a value. The parameters can also be ignored in function definition while the function has no need to take any parameters from the caller. The syntax is as follows:

Function definition with return type

```
sub type <name> [(parameters)]
    Local variable declarations
    [Statements]
    [return [value]]
end sub
```

Example:

```
sub int Add(int x, int y)
    int result
    result = x +y
    return result
end sub

macro_command main()
    int a = 10, b = 20, sum
    sum = Add(a, b)
end macro_command
```

or:

```
sub int Add()
    int result, x=10, y=20
    result = x +y
    return result
end sub

macro_command main()
    int sum
    sum = Add()
end macro_command
```

Function definition without return type

```
sub <name> [(parameters)]
    Local variable declarations
    [Statements]
end sub
```

Example:

```
sub Add(int x, int y)
    int result
    result = x +y
```

```
end sub
```

```
macro_command main()
    int a = 10, b = 20
    Add(a, b)
end macro_command
```

or:

```
sub Add()
    int result, x=10, y=20
    result = x +y
end sub
```

```
macro_command main()
    Add()
end macro_command
```

Syntax description

sub	Must be used to begin the function block
type	Optional. This is the data type of value that the function returns. A function block is not always necessary to return a value.
(parameters)	Optional. The parameters hold values that are passed to the function. The passed parameters must have their type declared in the parameter field and assigned a variable name. For example: sub int MyFunction(int x, int y). x and y would be integers passed to the function. This function is called by a statement that looks similar to this: ret = MyFunction(456, pressure) where “pressure” must be integer according to the definition of function. Notice that the calling statement can pass hard coded values or variables to the function. After this function is executed, an integer values is return to ‘ret’.
Local variable declaration	Variables that are used in the function block must be declared first. This is in addition to passed parameters. In the above example x and y are variables that the function can used. Global variables are also available for use in function block.
[Statements]	Statements to execute
[return [value]]	Optional. Used to return a value to the calling statement. The value can be a constant or a variable. Return also ends function block execution. A function block is not always necessary to return a value, but, when the return type is defined in the beginning of the definition of function, the return command is needed.
end sub	Must be used to end a function block.

18.7. Built-In Function Block

EasyBuilder Pro has many built-in functions for retrieving and transferring data to the PLC, data management and mathematical functions.

18.7.1. Mathematical Functions

Name	SQRT
Syntax	SQRT(<i>source</i> , <i>result</i>)
Description	Calculate the square root of <i>source</i> and store the result into <i>result</i> . <i>source</i> can be a constant or a variable. <i>result</i> must be a variable. <i>source</i> must be a nonnegative value.
Example	<pre>macro_command main() float source, result SQRT(15, result) source = 9.0 SQRT(source, result)// result is 3.0 end macro_command</pre>

Name	CUBERT
Syntax	CUBERT(<i>source</i> , <i>result</i>)
Description	Calculate the cube root of <i>source</i> and store the result into <i>result</i> . <i>source</i> can be a constant or a variable. <i>result</i> must be a variable. <i>source</i> must be a nonnegative value.
Example	<pre>macro_command main() float source, result CUBERT (27, result) // result is 3.0 source = 27.0 CUBERT(source, result)// result is 3.0 end macro_command</pre>

Name	POW
Syntax	POW(<i>source1</i> , <i>source2</i> , <i>result</i>)
Description	Calculate <i>source1</i> to the power of <i>source2</i> . <i>source1</i> and <i>source2</i> can be a constant or a variable. <i>result</i> must be a variable. <i>source1</i> and <i>source2</i> must be a nonnegative value.

Example	<pre>macro_command main() float y, result y = 0.5 POW (25, y, result) // result = 5 end macro_command</pre>
----------------	---

Name	SIN
Syntax	SIN(<i>source</i> , <i>result</i>)
Description	Calculate the sine of <i>source</i> (degree) into <i>result</i> . <i>source</i> can be a constant or a variable. <i>result</i> must be a variable.
Example	<pre>macro_command main() float source, result SIN(90, result)// result is 1 source = 30 SIN(source, result)// result is 0.5 end macro_command</pre>

Name	COS
Syntax	COS(<i>source</i> , <i>result</i>)
Description	Calculate the cosine of <i>source</i> (degree) into <i>result</i> . <i>source</i> can be a constant or a variable. <i>result</i> must be a variable.
Example	<pre>macro_command main() float source, result COS(90, result)// result is 0 source = 60 GetData(source, "Local HMI", LW, 0, 1) COS(source, result)// result is 0.5 end macro_command</pre>

Name	TAN
Syntax	TAN(<i>source</i> , <i>result</i>)
Description	Calculate the tangent of <i>source</i> (degree) into <i>result</i> . <i>source</i> can be a constant or a variable. <i>result</i> must be a variable.
Example	<pre>macro_command main() float source, result TAN(45, result)// result is 1</pre>

```
source = 60
TAN(source, result)// result is 1.732

end macro_command
```

Name	COT
Syntax	COT(<i>source</i> , <i>result</i>)
Description	Calculate the cotangent of <i>source</i> (degree) into <i>result</i> . <i>source</i> can be a constant or a variable. <i>result</i> must be a variable.
Example	<pre>macro_command main() float source, result COT(45, result)// result is 1 source = 60 COT(source, result)// result is 0.5774 end macro_command</pre>

Name	SEC
Syntax	SEC(<i>source</i> , <i>result</i>)
Description	Calculate the secant of <i>source</i> (degree) into <i>result</i> . <i>source</i> can be a constant or a variable. <i>result</i> must be a variable.
Example	<pre>macro_command main() float source, result SEC(45, result)// result is 1.414 source = 60 SEC(source, result)// if source is 60, result is 2 end macro_command</pre>

Name	CSC
Syntax	CSC(<i>source</i> , <i>result</i>)
Description	Calculate the cosecant of <i>source</i> (degree) into <i>result</i> . <i>source</i> can be a constant or a variable. <i>result</i> must be a variable.
Example	<pre>macro_command main() float source, result CSC(45, result)// result is 1.414 source = 30 CSC(source, result)// result is 2 end macro_command</pre>

Name	ASIN
Syntax	ASIN(<i>source</i> , <i>result</i>)
Description	Calculate the arc sine of <i>source</i> into <i>result</i> (degree). <i>source</i> can be a constant or a variable. <i>result</i> must be a variable.
Example	<pre>macro_command main() float source, result ASIN(0.8660, result)// result is 60 source = 0.5 ASIN(source, result)// result is 30 end macro_command</pre>

Name	ACOS
Syntax	ACOS(<i>source</i> , <i>result</i>)
Description	Calculate the arc cosine of <i>source</i> into <i>result</i> . <i>source</i> can be a constant or a variable. <i>result</i> must be a variable.
Example	<pre>macro_command main() float source, result ACOS(0.8660, result)// result is 30 source = 0.5 ACOS(source, result)// result is 60 end macro_command</pre>

Name	ATAN
Syntax	ATAN(<i>source</i> , <i>result</i>)
Description	Calculate the arc tangent of <i>source</i> into <i>result</i> . <i>source</i> can be a constant or a variable. <i>result</i> must be a variable.
Example	<pre>macro_command main() float source, result ATAN(1, result)// result is 45 source = 1.732 ATAN(source, result)// result is 60 end macro_command</pre>

Name	LOG
Syntax	LOG (<i>source</i> , <i>result</i>)
Description	Calculates the natural logarithm of a number. <i>source</i> can be either a variable or a constant. <i>result</i> must be a variable.
Example	macro_command main() float source = 100, result LOG (source, result)// result is approximately 4.6052 end macro_command

Name	LOG10
Syntax	LOG10(<i>source</i> , <i>result</i>)
Description	Calculates the base-10 logarithm of a number. <i>source</i> can be either a variable or a constant. <i>result</i> must be a variable.
Example	macro_command main() float source = 100, result LOG10 (source, result) // result is 2 end macro_command

Name	RAND
Syntax	RAND(<i>result</i>)
Description	Calculates a random integer and save into <i>result</i> . <i>result</i> must be a variable.
Example	macro_command main() short result RAND (result) //result is not a fixed value when executes macro every time end macro_command

18.7.2. Data Transformation

Name	BIN2BCD
Syntax	BIN2BCD(<i>source</i> , <i>result</i>)
Description	Transforms a binary-type value (<i>source</i>) into a BCD-type value (<i>result</i>). <i>source</i> can be a constant or a variable. <i>result</i> must be a variable.
Example	<pre>macro_command main() short source, result BIN2BCD(1234, result)// result is 0x1234 source = 5678 BIN2BCD(source, result)// result is 0x5678 end macro_command</pre>

Name	BCD2BIN
Syntax	BCD2BIN(<i>source</i> , <i>result</i>)
Description	Transforms a BCD-type value (<i>source</i>) into a binary-type value (<i>result</i>). <i>source</i> can be a constant or a variable. <i>result</i> must be a variable.
Example	<pre>macro_command main() short source, result BCD2BIN(0x1234, result)// result is 1234 source = 0x5678 BCD2BIN(source, result)// result is 5678 end macro_command</pre>

Name	DEC2ASCII
Syntax	DEC2ASCII(<i>source</i> , <i>result</i> [<i>start</i>], <i>len</i>)
Description	<p>Transforms a decimal value (<i>source</i>) into an ASCII string and save it to an array (<i>result</i>).</p> <p><i>len</i> represents the length of the string and the unit of length depends on <i>result</i>'s type., i.e. if <i>result</i>'s type is "char" (the size is byte), the length of the string is (byte * <i>len</i>). If <i>result</i>'s type is "short" (the size is word), the length of the string is (word * <i>len</i>), and so on.</p> <p>The first character is put into <i>result</i>[<i>start</i>], the second character is put into <i>result</i>[<i>start</i> + 1], and the last character is put into <i>result</i>[<i>start</i> + (<i>len</i> - 1)].</p> <p><i>source</i> and <i>len</i> can be a constant or a variable. <i>result</i> must be a variable. <i>start</i> must be a constant.</p>
Example	<pre>macro_command main()</pre>

```

short source
char result1[4]
short result2[4]
char result3[6]
source = 5678

DEC2ASCII(source, result1[0], 4)
// result1[0] is '5', result1[1] is '6', result1[2] is '7', result1[3] is '8'
// the length of the string (result1) is 4 bytes( = 1 * 4)
DEC2ASCII(source, result2[0], 4)
// result2[0] is '5', result2[1] is '6', result2[2] is '7', result2[3] is '8'
// the length of the string (result2) is 8 bytes( = 2 * 4)

source=-123
DEC2ASCII(source3, result3[0], 6)
// result1[0] is '-', result1[1] is '0', result1[2] is '0', result1[3] is '1'
// result1[4] is '2', result1[5] is '3'
// the length of the string (result1) is 6 bytes( = 1 * 6)

end macro_command

```

Name	HEX2ASCII
Syntax	HEX2ASCII(<i>source</i> , <i>result[start]</i> , <i>len</i>)
Description	<p>Transforms a hexadecimal value (<i>source</i>) into ASCII string saved to an array (<i>result</i>).</p> <p><i>len</i> represents the length of the string and the unit of length depends on result's type., i.e. if result's type is "char" (the size is byte), the length of the string is (byte * <i>len</i>). If result's type is "short" (the size is word), the length of the string is (word * <i>len</i>), and so on.</p> <p><i>source</i> and <i>len</i> can be a constant or a variable. <i>result</i> must be a variable. <i>start</i> must be a constant.</p>
Example	<pre> macro_command main() short source char result[4] source = 0x5678 HEX2ASCII (source, result[0], 4) // result[0] is '5', result[1] is '6', result[2] is '7', result[3] is '8' end macro_command </pre>

Name	FLOAT2ASCII
Syntax	FLOAT2ASCII(<i>source</i> , <i>result</i> [<i>start</i>], <i>len</i>)
Description	Transforms a floating value (<i>source</i>) into ASCII string saved to an array (<i>result</i>). <i>len</i> represents the length of the string and the unit of length depends on result's type., i.e. if result's type is "char" (the size is byte), the length of the string is (byte * <i>len</i>). If result's type is "short" (the size is word), the length of the string is (word * <i>len</i>), and so on. <i>source</i> and <i>len</i> can be a constant or a variable. <i>result</i> must be a variable. <i>start</i> must be a constant.
Example	<pre>macro_command main() float source char result[4] source = 56.8 FLOAT2ASCII (source, result[0], 4) // result[0] is '5', result[1] is '6', result[2] is '.', result[3] is '8' end macro_command</pre>

Name	ASCII2DEC
Syntax	ASCII2DEC(<i>source</i> [<i>start</i>], <i>result</i> , <i>len</i>)
Description	Transforms a string (<i>source</i>) into a decimal value saved to a variable (<i>result</i>). The length of the string is <i>len</i> . The first character of the string is <i>source</i> [<i>start</i>]. <i>source</i> and <i>len</i> can be a constant or a variable. <i>result</i> must be a variable. <i>start</i> must be a constant.
Example	<pre>macro_command main() char source[4] short result source[0] = '5' source[1] = '6' source[2] = '7' source[3] = '8' ASCII2DEC(source[0], result, 4) // result is 5678 end macro_command</pre>

Name	ASCII2HEX
Syntax	ASCII2HEX (<i>source[start]</i> , <i>result</i> , <i>len</i>)
Description	<p>Transforms a string (<i>source</i>) into a hexadecimal value saved to a variable (<i>result</i>).</p> <p>The length of the string is <i>len</i>. The first character of the string is <i>source[start]</i>. <i>source</i> and <i>len</i> can be a constant or a variable. <i>result</i> must be a variable. <i>start</i> must be a constant.</p>
Example	<pre>macro_command main() char source[4] short result source[0] = '5' source[1] = '6' source[2] = '7' source[3] = '8' ASCII2HEX (source[0], result, 4) // result is 0x5678 end macro_command</pre>

Name	ASCII2FLOAT
Syntax	ASCII2FLOAT(<i>source[start]</i> , <i>result</i> , <i>len</i>)
Description	<p>Transforms a string (<i>source</i>) into a float value saved to a variable (<i>result</i>).</p> <p>The length of the string is <i>len</i>. The first character of the string is <i>source[start]</i>. <i>source</i> and <i>len</i> can be a constant or a variable. <i>result</i> must be a variable. <i>start</i> must be a constant.</p>
Example	<pre>macro_command main() char source[4] float result source[0] = '5' source[1] = '6' source[2] = '.' source[3] = '8' ASCII2FLOAT (source[0], result, 4) // result is 56.8 end macro_command</pre>

18.7.3. Data Manipulation

Name	FILL
Syntax	FILL(<i>source</i> [<i>start</i>], <i>preset</i> , <i>count</i>)
Description	Sets the first <i>count</i> elements of an array (<i>source</i>) to a specified value (<i>preset</i>). <i>source</i> and <i>start</i> must be a variable, and <i>preset</i> can be a constant or variable.
Example	<pre>macro_command main() char result[4] char preset FILL(result[0], 0x30, 4) // result[0] is 0x30, result[1] is 0x30, , result[2] is 0x30, , result[3] is 0x30 preset = 0x31 FILL(result[0], preset, 2) // result[0] is 0x31, result[1] is 0x31 end macro_command</pre>

Name	SWAPB
Syntax	SWAPB(<i>source</i> , <i>result</i>)
Description	Exchanges the high-byte and low-byte data of a 16-bit <i>source</i> into <i>result</i> . <i>source</i> can be a constant or a variable. <i>result</i> must be a variable.
Example	<pre>macro_command main() short source, result SWAPB(0x5678, result)// result is 0x7856 source = 0x123 SWAPB(source, result)// result is 0x2301 end macro_command</pre>

Name	SWAPW
Syntax	SWAPW(<i>source</i> , <i>result</i>)
Description	Exchanges the high-word and low-word data of a 32-bit <i>source</i> into <i>result</i> . <i>source</i> can be a constant or a variable. <i>result</i> must be a variable.
Example	<pre>macro_command main() int source, result SWAPW (0x12345678, result)// result is 0x56781234 source = 0x12345 SWAPW (source, result)// result is 0x23450001 end macro_command</pre>

Name	LOBYTE
Syntax	LOBYTE(<i>source</i> , <i>result</i>)
Description	Retrieves the low byte of a 16-bit <i>source</i> into <i>result</i> . <i>source</i> can be a constant or a variable. <i>result</i> must be a variable.
Example	<pre>macro_command main() short source, result LOBYTE(0x1234, result)// result is 0x34 source = 0x123 LOBYTE(source, result)// result is 0x23 end macro_command</pre>

Name	HIBYTE
Syntax	HIBYTE(<i>source</i> , <i>result</i>)
Description	Retrieves the high byte of a 16-bit <i>source</i> into <i>result</i> . <i>source</i> can be a constant or a variable. <i>result</i> must be a variable.
Example	<pre>macro_command main() short source, result HIBYTE(0x1234, result)// result is 0x12 source = 0x123 HIBYTE(source, result)// result is 0x01 end macro_command</pre>

Name	LOWORD
Syntax	LOWORD(<i>source</i> , <i>result</i>)
Description	Retrieves the low word of a 32-bit <i>source</i> into <i>result</i> . <i>source</i> can be a constant or a variable. <i>result</i> must be a variable.
Example	<pre>macro_command main() int source, result LOWORD(0x12345678, result)// result is 0x5678 source = 0x12345 LOWORD(source, result)// result is 0x2345 end macro_command</pre>

Name	HIWORD
Syntax	HIWORD(<i>source</i> , <i>result</i>)
Description	Retrieves the high word of a 32-bit source into result. <i>source</i> can be a constant or a variable. <i>result</i> must be a variable.
Example	<pre>macro_command main() int source, result HIWORD(0x12345678, result)// result is 0x1234 source = 0x12345 HIWORD(source, result)// result is 0x0001 end macro_command</pre>

18.7.4. Bit Transformation

Name	GETBIT
Syntax	GETBIT(<i>source</i> , <i>result</i> , <i>bit_pos</i>)
Description	Gets the state of designated bit position of a data (<i>source</i>) into <i>result</i> . <i>result</i> value will be 0 or 1. <i>source</i> and <i>bit_pos</i> can be a constant or a variable. <i>result</i> must be a variable.
Example	<pre>macro_command main() int source, result short bit_pos GETBIT(9, result, 3)// result is 1 source = 4 bit_pos = 2 GETBIT(source, result, bit_pos)// result is 1 end macro_command</pre>

Name	SETBITON
Syntax	SETBITON(<i>source</i> , <i>result</i> , <i>bit_pos</i>)
Description	Changes the state of designated bit position of a data (<i>source</i>) to 1, and put changed data into <i>result</i> . <i>source</i> and <i>bit_pos</i> can be a constant or a variable. <i>result</i> must be a variable.
Example	<pre>macro_command main() int source, result short bit_pos SETBITON(1, result, 3)// result is 9 source = 0 bit_pos = 2 SETBITON (source, result, bit_pos)// result is 4 end macro_command</pre>

Name	SETBITOFF
Syntax	SETBITOFF(<i>source</i> , <i>result</i> , <i>bit_pos</i>)
Description	Changes the state of designated bit position of a data (<i>source</i>) to 0, and put in changed data into <i>result</i> . <i>source</i> and <i>bit_pos</i> can be a constant or a variable. <i>result</i> must be a variable.
Example	<pre>macro_command main() int source, result short bit_pos SETBITOFF(9, result, 3)// result is 1 source = 4 bit_pos = 2 SETBITOFF(source, result, bit_pos)// result is 0 end macro_command</pre>

Name	INVBIT
Syntax	INVBIT(<i>source</i> , <i>result</i> , <i>bit_pos</i>)
Description	Inverts the state of designated bit position of a data (<i>source</i>), and put changed data into <i>result</i> . <i>source</i> and <i>bit_pos</i> can be a constant or a variable. <i>result</i> must be a variable.
Example	<pre>macro_command main() int source, result short bit_pos INVBIT(4, result, 1)// result = 6 source = 6 bit_pos = 1 INVBIT(source, result, bit_pos)// result = 4 end macro_command</pre>

18.7.5. Communication

Name	DELAY
Syntax	DELAY(<i>time</i>)
Description	Suspends the execution of the current macro for at least the specified interval (<i>time</i>). The unit of <i>time</i> is millisecond. <i>time</i> can be a constant or a variable.
Example	<pre>macro_command main() int time == 500 DELAY(100)// delay 100 ms DELAY(time)// delay 500 ms end macro_command</pre>

Name	ADDSUM
Syntax	ADDSUM(<i>source</i> [<i>start</i>], <i>result</i> , <i>data_count</i>)
Description	Adds up the elements of an array (<i>source</i>) from <i>source</i> [<i>start</i>] to <i>source</i> [<i>start</i> + <i>data_count</i> - 1] to generate a checksum. Puts in the checksum into <i>result</i> . <i>result</i> must be a variable. <i>data_count</i> is the amount of the accumulated elements and can be a constant or a variable.
Example	<pre>macro_command main() char data[5] short checksum data[0] = 0x1 data[1] = 0x2 data[2] = 0x3 data[3] = 0x4 data[4] = 0x5 ADDSUM(data[0], checksum, 5)// checksum is 0xf end macro_command</pre>

Name	XORSUM
Syntax	XORSUM(<i>source</i> [<i>start</i>], <i>result</i> , <i>data_count</i>)
Description	Uses an exclusion method to calculate the checksum from <i>source</i> [<i>start</i>] to <i>source</i> [<i>start</i> + <i>data_count</i> - 1]. Puts the checksum into <i>result</i> . <i>result</i> must be a variable. <i>data_count</i> is the amount of the calculated elements of the array and can be a constant or a variable.
Example	<pre>macro_command main() char data[5] = {0x1, 0x2, 0x3, 0x4, 0x5} short checksum XORSUM(data[0], checksum, 5)// checksum is 0x1 end macro_command</pre>

Name	BCC
Syntax	BCC(<i>source</i> [<i>start</i>], <i>result</i> , <i>data_count</i>)
Description	Uses an XOR method to calculate the checksum from <i>source</i> [<i>start</i>] to <i>source</i> [<i>start</i> + <i>data_count</i> - 1]. Puts the checksum into <i>result</i> . <i>result</i> must be a variable. <i>data_count</i> is the amount of the calculated elements of the array and can be a constant or a variable.
Example	<pre>macro_command main() char data[5] = {0x1, 0x2, 0x3, 0x4, 0x5} char checksum</pre>

```
BCC(source[0], checksum, 5) // checksum is 0x1

end macro_command
```

Name	CRC
Syntax	CRC(<i>source[start]</i> , <i>result</i> , <i>data_count</i>)
Description	Calculates 16-bit CRC of the variables from <i>source[start]</i> to <i>source[start + data_count - 1]</i> . Puts in the 16-bit CRC into <i>result</i> . <i>result</i> must be a variable. <i>data_count</i> is the amount of the calculated elements of the array and can be a constant or a variable.
Example	<pre>macro_command main() char data[5] = {0x1, 0x2, 0x3, 0x4, 0x5} short 16bit_CRC CRC(data[0], 16bit_CRC, 5)// 16bit_CRC is 0xbb2a end macro_command</pre>

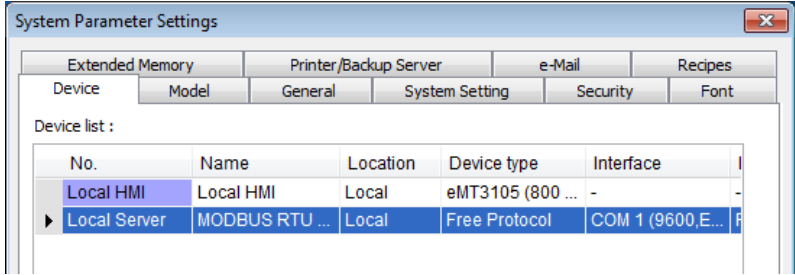
Name	OUTPORT
Syntax	OUTPORT(<i>source[start]</i> , <i>device_name</i> , <i>data_count</i>)
Description	Sends out the specified data from <i>source[start]</i> to <i>source[start + count - 1]</i> to PLC via a COM port or the ethernet. <i>device_name</i> is the name of a device defined in the device table and the device must be a "Free Protocol"-type device. <i>data_count</i> is the amount of sent data and can be a constant or a variable.
Example	<p>To use an OUTPORT function, a "Free Protocol" device must be created first as follows:</p>  <p>The device is named "MODBUS RTU Device". The port attribute depends on the setting of this device. (the current setting is "19200,E, 8, 1")</p> <p>Below is an example of executing an action of writing single coil (SET ON) to a MODBUS device.</p> <pre>macro_command main() char command[32] short address, checksum</pre>

	<pre> FILL(command[0], 0, 32)// command initialization command[0] = 0x1// station no command[1] = 0x5// function code : Write Single Coil address = 0 HIBYTE(address, command[2]) LOBYTE(address, command[3]) command[4] = 0xff// force bit on command[5] = 0 CRC(command[0], checksum, 6) LOBYTE(checksum, command[6]) HIBYTE(checksum, command[7]) // send out a "Write Single Coil" command OUTPORT(command[0], "MODBUS RTU Device", 8) end macro_command </pre>
--	---

Name	INPORT
Syntax	INPORT(<i>read_data[start]</i> , <i>device_name</i> , <i>read_count</i> , <i>return_value</i>)
Description	<p>Reads data from a COM port or the ethernet. These data is stored to <i>read_data[start]~read_data[start + read_count - 1]</i>.</p> <p><i>device_name</i> is the name of a device defined in the device table and the device must be a "Free Protocol"-type device.</p> <p><i>read_count</i> is the required amount of reading and can be a constant or a variable.</p> <p>If the function is used successfully to get sufficient data, <i>return_value</i> is 1, otherwise is 0.</p>
Example	<p>Below is an example of executing an action of reading holding registers of a MODBUS device.</p> <pre> // Read Holding Registers macro_command main() char command[32], response[32] short address, checksum short read_no, return_value, read_data[2] FILL(command[0], 0, 32)// command initialization FILL(response[0], 0, 32) </pre>

```

command[0] = 0x1//  station no
command[1] = 0x3//  function code : Read Holding Registers

address = 0
HIBYTE(address, command[2])
LOBYTE(address, command[3])

read_no = 2//  read 2 words (4x_1 and 4x_2)
HIBYTE(read_no, command[4])
LOBYTE(read_no, command[5])

CRC(command[0], checksum, 6)

LOBYTE(checksum, command[6])
HIBYTE(checksum, command[7])

//  send out a 'Read Holding Registers" command
OUTPORT(command[0], "MODBUS RTU Device", 8)

//  read responses for a 'Read Holding Registers" command
INPORT(response[0], "MODBUS RTU Device", 9, return_value)

if return_value > 0 then
read_data[0] = response[4] + (response[3] << 8)//  data in 4x_1
read_data[1] = response[6] + (response[5] << 8)//  data in 4x_2

SetData(read_data[0], "Local HMI", LW, 100, 2)
end if

end macro_command

```

Name	INPORT2
Syntax	INPORT2(<i>response[start]</i> , <i>device_name</i> , <i>receive_len</i> , <i>wait_time</i>)
Description	<p>Read data from a communication port (COM Port or Ethernet Port). The data read will be saved in response. The description of <i>device_name</i> is the same as OUTPORT.</p> <p><i>receive_len</i> stores the length of the data received, this must be a variable. <i>receive_len</i> total length can't exceed the size of response.</p> <p><i>wait_time</i> (in millisecond) can be a constant or variable. After the data is read, if there's no upcoming data during the designated time interval, the function returns.</p>
Example	<pre>macro_command main() short wResponse[6], receive_len, wait_time=20</pre>

	<pre> INPORT2(wResponse[0], "Free Protocol", receive_len, wait_time) // wait_time unit : millisecond if receive_len > 0 then SetData(wResponse[0], "Local HMI", LW, 0, 6) // set responses to LW0 end if end macro_command </pre>
--	--

Name	INPORT3
Syntax	INPORT3(<i>response[start]</i> , <i>device_name</i> , <i>read_count</i> , <i>receive_len</i>)
Description	<p>Read data from a communication port (COM Port or Ethernet Port). The data read will be saved in response.</p> <p>The amount of data to be read can be specified. The data that is not read yet will be stored in HMI buffer memory for the next read operation, in order to prevent losing data. The description of <i>device_name</i> is the same as OUTPORT. <i>read_count</i> stores the length of the data read each time. <i>receive_len</i> stores the length of the data received, this must be a variable. <i>receive_len</i> total length can't exceed the size of response.</p>
Example	<pre> macro_command main() short wResponse[6], receive_len INPORT3(wResponse[0], "Free Protocol", 6, receive_len) // read 6 words if receive_len >= 6 then SetData(wResponse[0], "Local HMI", LW, 0, 6) // set responses to LW0 end if end macro_command </pre>

Name	GetData
Syntax	<pre> GetData(<i>read_data[start]</i>, <i>device_name</i>, <i>device_type</i>, <i>address_offset</i>, <i>data_count</i>) or GetData(<i>read_data</i>, <i>device_name</i>, <i>device_type</i>, <i>address_offset</i>, 1) </pre>
Description	<p>Receives data from the PLC. Data is stored into <i>read_data[start]</i>~<i>read_data[start + data_count - 1]</i>. <i>data_count</i> is the amount of received data. In general, <i>read_data</i> is an array, but if <i>data_count</i> is 1, <i>read_data</i> can be an array or an ordinary variable. Below are two methods to read one word data from PLC.</p> <pre> macro_command main() </pre>

```

short read_data_1[2], read_data_2
GetData(read_data_1[0], "FATEK KB Series", RT, 5, 1)
GetData(read_data_2, "FATEK KB Series", RT, 5, 1)
end macro_command

```

Device_name is the PLC name enclosed in the double quotation marks (“”) and this name has been defined in the device list of system parameters as follows (see FATEK KB Series):

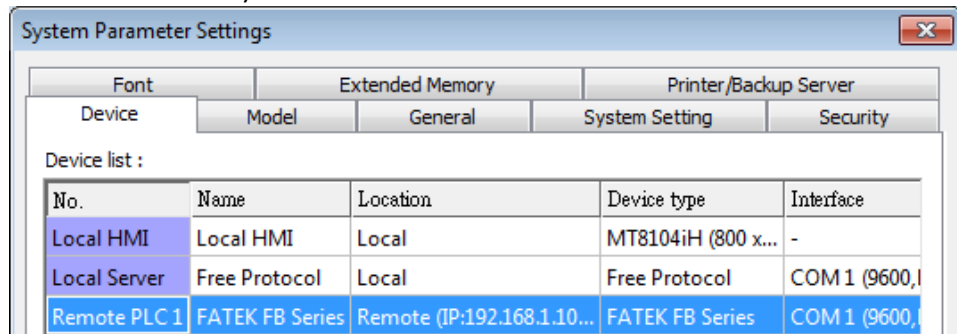

Device_type is the device type and encoding method (binary or BCD) of the PLC data. For example, if *device_type* is LW_BIN, it means the register is LW and the encoding method is binary. If use BIN encoding method, “_BIN” can be ignored. If *device_type* is LW_BCD, it means the register is LW and the encoding method is BCD.

Address_offset is the address offset in the PLC.

For example, `GetData(read_data_1[0], "FATEK KB Series", RT, 5, 1)` represents that the address offset is 5.

If *address_offset* uses the format – “N#AAAAA”, N indicates that PLC’s station number is N. AAAAA represents the address offset. This format is used while multiple PLCs or controllers are connected to a single serial port. For example, `GetData(read_data_1[0], "FATEK KB Series", RT, 2#5, 1)` represents that the PLC’s station number is 2. If `GetData()` uses the default station number defined in the device list as follows, it is not necessary to define station number in *address_offset*.

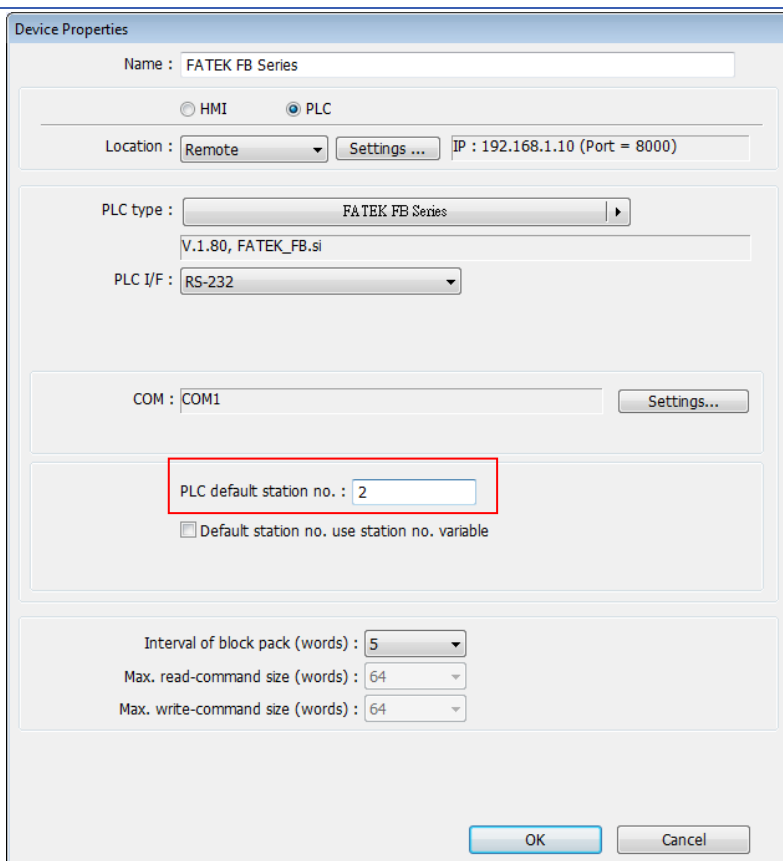

The number of registers actually read from depends on both the type of the *read_data* variable and the value of the number of *data_count*.

type of read_data	data_count	actual number of 16-bit register read
char (8-bit)	1	1
char (8-bit)	2	1
bool (8-bit)	1	1
bool (8-bit)	2	1
short (16-bit)	1	1
short (16-bit)	2	2
int (32-bit)	1	2
int (32-bit)	2	4
float (32-bit)	1	2
float (32-bit)	2	4

When a `GetData()` is executed using a 32-bit data type (int or float), the function will automatically convert the data. For example,

```
macro_command main()
float f
GetData(f, "MODBUS", 6x, 2, 1) // f will contain a floating point value
end macro_command
```

Example

```
macro_command main()
bool a
```

	<pre> bool b[30] short c short d[50] int e int f[10] double g[10] // get the state of LB2 to the variable a GetData(a, "Local HMI", LB, 2, 1) // get 30 states of LB0 ~ LB29 to the variables b[0] ~ b[29] GetData(b[0], "Local HMI", LB, 0, 30) // get one word from LW-2 to the variable c GetData(c, "Local HMI", LW, 2, 1) // get 50 words from LW-0 ~ LW-49 to the variables d[0] ~ d[49] GetData(d[0], "Local HMI", LW, 0, 50) // get 2 words from LW-6 ~ LW-7 to the variable e // note that the type of e is int GetData(e, "Local HMI", LW, 6, 1) // get 20 words (10 integer values) from LW-0 ~ LW-19 to variables f[0] ~ f[9] // since each integer value occupies 2 words GetData(f[0], "Local HMI", LW, 0, 10) // get 2 words from LW-2 ~ LW-3 to the variable f GetData(f, "Local HMI", LW, 2, 1) end macro_command </pre>
--	---

Name	GetDataEx
Syntax	<pre> GetDataEx(<i>read_data</i>[<i>start</i>], <i>device_name</i>, <i>device_type</i>, <i>address_offset</i>, <i>data_count</i>) or GetDataEx(<i>read_data</i>, <i>device_name</i>, <i>device_type</i>, <i>address_offset</i>, 1) </pre>
Description	<p>Receives data from the PLC and continue executing next command even if no response from this device.</p> <p>Descriptions of <i>read_data</i>, <i>device_name</i>, <i>device_type</i>, <i>address_offset</i> and <i>data_count</i> are the same as GetData.</p>
Example	<pre> macro_command main() bool a bool b[30] </pre>

```

short c
short d[50]
int e
int f[10]
double g[10]

// get the state of LB2 to the variable a
GetDataEx (a, "Local HMI", LB, 2, 1)

// get 30 states of LB0 ~ LB29 to the variables b[0] ~ b[29]
GetDataEx (b[0], "Local HMI", LB, 0, 30)

// get one word from LW-2 to the variable c
GetDataEx (c, "Local HMI", LW, 2, 1)

// get 50 words from LW-0 ~ LW-49 to the variables d[0] ~ d[49]
GetDataEx (d[0], "Local HMI", LW, 0, 50)

// get 2 words from LW-6 ~ LW-7 to the variable e
// note that the type of e is int
GetDataEx (e, "Local HMI", LW, 6, 1)

// get 20 words (10 integer values) from LW-0 ~ LW-19 to f[0] ~ f[9]
// since each integer value occupies 2 words
GetDataEx (f[0], "Local HMI", LW, 0, 10)

// get 2 words from LW-2 ~ LW-3 to the variable f
GetDataEx (f, "Local HMI", LW, 2, 1)

end macro_command

```

Name	SetData
Syntax	SetData(<i>send_data[start]</i> , <i>device_name</i> , <i>device_type</i> , <i>address_offset</i> , <i>data_count</i>) or SetData(<i>send_data</i> , <i>device_name</i> , <i>device_type</i> , <i>address_offset</i> , 1)
Description	Send data to the PLC. Data is defined in <i>send_data[start]</i> ~ <i>send_data[start + data_count - 1]</i> . <i>data_count</i> is the amount of sent data. In general, <i>send_data</i> is an array, but if <i>data_count</i> is 1, <i>send_data</i> can be an array or an ordinary variable. Below are two methods to send one word data. <pre> macro_command main() short send_data_1[2] = { 5, 6}, send_data_2 = 5 SetData(send_data_1[0], "FATEK KB Series", RT, 5, 1) </pre>

```
SetData(send_data_2, "FATEK KB Series", RT, 5, 1)
end macro_command
```

device_name is the PLC name enclosed in the double quotation marks (“”) and this name has been defined in the device list of system parameters.

device_type is the device type and encoding method (binary or BCD) of the PLC data. For example, if *device_type* is LW_BIN, it means the register is LW and the encoding method is binary. If use BIN encoding method, “_BIN” can be ignored. If *device_type* is LW_BCD, it means the register is LW and the encoding method is BCD.

address_offset is the address offset in the PLC.

For example, SetData(read_data_1[0], “FATEK KB Series”, RT, 5, 1) represents that the address offset is 5.

If *address_offset* uses the format – “N#AAAAA”, N indicates that PLC’s station number is N. AAAAA represents the address offset. This format is used while multiple PLCs or controllers are connected to a single serial port. For example, SetData(read_data_1[0], “FATEK KB Series”, RT, 2#5, 1) represents that the PLC’s station number is 2. If SetData () uses the default station number defined in the device list, it is not necessary to define station number in *address_offset*.

The number of registers actually sends to depends on both the type of the *send_data* variable and the value of the number of *data_count*.

type of <i>read_data</i>	<i>data_count</i>	actual number of 16-bit register send
char (8-bit)	1	1
char (8-bit)	2	1
bool (8-bit)	1	1
bool (8-bit)	2	1
short (16-bit)	1	1
short (16-bit)	2	2
int (32-bit)	1	2
int (32-bit)	2	4
float (32-bit)	1	2
float (32-bit)	2	4

When a SetData() is executed using a 32-bit data type (int or float), the function will automatically send int-format or float-format data to the device. For example,

```
macro_command main()
float f = 2.6
SetData(f, "MODBUS", 6x, 2, 1) // will send a floating point value to the device
end macro_command
```

Example

```
macro_command main()
int i
```



```

bool a = true
bool b[30]
short c = false
short d[50]
int e = 5
int f[10]

for i = 0 to 29
b[i] = true
next i

for i = 0 to 49
d[i] = i * 2
next i

for i = 0 to 9
f [i] = i * 3
next i

// set the state of LB2
SetData(a, "Local HMI", LB, 2, 1)

// set the states of LB0 ~ LB29
SetData(b[0], "Local HMI", LB, 0, 30)

// set the value of LW-2
SetData(c, "Local HMI", LW, 2, 1)

// set the values of LW-0 ~ LW-49
SetData(d[0], "Local HMI", LW, 0, 50)

// set the values of LW-6 ~ LW-7, note that the type of e is int
SetData(e, "Local HMI", LW, 6, 1)

// set the values of LW-0 ~ LW-19
// 10 integers equal to 20 words, since each integer value occupies 2 words.
SetData(f[0], "Local HMI", LW, 0, 10)

end macro_command

```

Name	SetDataEx
Syntax	SetDataEx (<i>send_data</i> [start], <i>device_name</i> , <i>device_type</i> , <i>address_offset</i> , <i>data_count</i>) or SetDataEx (<i>send_data</i> , <i>device_name</i> , <i>device_type</i> , <i>address_offset</i> , 1)

Description	Send data to the PLC and continue executing next command even if no response from this device. Descriptions of <i>send_data</i> , <i>device_name</i> , <i>device_type</i> , <i>address_offset</i> and <i>data_count</i> are the same as SetData.
Example	<pre> macro_command main() int i bool a = true bool b[30] short c = false short d[50] int e = 5 int f[10] for i = 0 to 29 b[i] = true next i for i = 0 to 49 d[i] = i * 2 next i for i = 0 to 9 f [i] = i * 3 next i // set the state of LB2 SetDataEx (a, "Local HMI", LB, 2, 1) // set the states of LB0 ~ LB29 SetDataEx (b[0], "Local HMI", LB, 0, 30) // set the value of LW-2 SetDataEx (c, "Local HMI", LW, 2, 1) // set the values of LW-0 ~ LW-49 SetDataEx (d[0], "Local HMI", LW, 0, 50) // set the values of LW-6 ~ LW-7, note that the type of e is int SetDataEx (e, "Local HMI", LW, 6, 1) // set the values of LW-0 ~ LW-19 // 10 integers equal to 20 words, since each integer value occupies 2 words. SetDataEx (f[0], "Local HMI", LW, 0, 10) end macro_command </pre>

Name	GetError
Syntax	GetError (<i>err</i>)
Description	Get an error code.
Example	<pre>macro_command main() short err char byData[10] GetDataEx(byData[0], "MODBUS RTU", 4x, 1, 10)// read 10 bytes // if err is equal to 0, it is successful to execute GetDataEx() GetErr(err)// save an error code to err end macro_command</pre>

Name	PURGE
Syntax	PURGE (<i>com_port</i>)
Description	<i>com_port</i> refers to the COM port number which ranges from 1 to 3. It can be either a variable or a constant. This function is used to clear the input and output buffers associated with the COM port.
Example	<pre>macro_command main() int com_port=3 PURGE (com_port) PURGE (1) end macro_command</pre>

Name	SetRTS
Syntax	SetRTS(<i>com_port, source</i>)
Description	<p>Set RTS state for RS232.</p> <p><i>com_port</i> refers to the COM port number. It can be either a variable or a constant. <i>source</i> can be either a variable or a constant.</p> <p>This command raise RTS signal while the value of <i>source</i> is greater than 0 and lower RTS signal while the value of <i>source</i> equals to 0.</p>
Example	<pre>macro_command main() char com_port=1 char value=1 SetRTS(com_port, value) // raise RTS signal of COM1 while value>0 SetRTS(1, 0) // lower RTS signal of COM1 end macro_command</pre>

Name	GetCTS
Syntax	GetCTS(<i>com_port</i> , <i>result</i>)
Description	Get CTS state for RS232. <i>com_port</i> refers to the COM port number. It can be either a variable or a constant. <i>result</i> is used for receiving the CTS signal. It must be a variable. This command receives CTS signal and stores the received data in the <i>result</i> variable. When the CTS signal is pulled high, it writes 1 to <i>result</i> , otherwise, it writes 0.
Example	<pre>macro_command main() char com_port=1 char result GetCTS(com_port, result) // get CTS signal of COM1 GetCTS (1, result) // get CTS signal of COM1 end macro_command</pre>

Name	GetCnvTagArrayIndex
Syntax	GetCnvTagArrayIndex(<i>array_index</i>)
Description	When an user-defined conversion tag uses array, the GetCnvTagArrayIndex() function of [Read conversion] subroutine can get the relative array index before doing conversion.
Example	<pre>Sub short newfun(short param) Int index GetCnvTagArrayIndex(index) If index is 2, the third data record in the array will be converted. return param end sub</pre>

18.7.6. String Operation Functions

Name	StringGet
Syntax	StringGet(<i>read_data</i> [<i>start</i>], <i>device_name</i> , <i>device_type</i> , <i>address_offset</i> , <i>data_count</i>)
Description	Receives data from the PLC. The String data is stored into <i>read_data</i> [<i>start</i>]~ <i>read_data</i> [<i>start</i> + <i>data_count</i> - 1]. <i>read_data</i> must be a one-dimensional char array. <i>Data_count</i> is the number of received characters, it can be either a constant or a variable. <i>Device_name</i> is the PLC name enclosed in the double quotation marks (") and this name has been defined in the device list of system parameters as follows (see FATEK KB Series):

System Parameter Settings				
Font		Extended Memory		Printer/Backup Server
Device	Model	General	System Setting	Security
Device list :				
No.	Name	Location	Device type	Interface
Local HMI	Local HMI	Local	MT8104iH (800 x...	-
Local Server	Free Protocol	Local	Free Protocol	COM 1 (9600,I
Remote PLC 1	FATEK FB Series	Remote (IP:192.168.1.10...	FATEK FB Series	COM 1 (9600,

Device_type is the device type and encoding method (binary or BCD) of the PLC data. For example, if device_type is LW_BIN, it means the register is LW and the encoding method is binary. If use BIN encoding method, “_BIN” can be ignored. If device_type is LW_BCD, it means the register is LW and the encoding method is BCD.

Address_offset is the address offset in the PLC.

For example, StringGet(read_data_1[0], “FATEK KB Series”, RT, 5, 1) represents that the address offset is 5.

If address_offset uses the format – “N#AAAAA”, N indicates that PLC’s station number is N. AAAAA represents the address offset. This format is used while multiple PLCs or controllers are connected to a single serial port. For example, StringGet(read_data_1[0], “FATEK KB Series”, RT, 2#5, 1) represents that the PLC’s station number is 2. If StringGet() uses the default station number defined in the device list as follows, it is not necessary to define station number in address_offset.

Device Properties

Name : FATEK FB Series

HMI PLC

Location : Remote [Settings ...] IP : 192.168.1.10 (Port = 8000)

PLC type : FATEK FB Series
V.1.80, FATEK_FB.sl

PLC I/F : RS-232

COM : COM1 [Settings...]

PLC default station no. : 2

Default station no. use station no. variable

Interval of block pack (words) : 5

Max. read-command size (words) : 64

Max. write-command size (words) : 64

OK Cancel

The number of registers actually read from depends on the value of the

	<p>number of <i>data_count</i> since that the <i>read_data</i> is restricted to char array.</p> <table border="1"> <thead> <tr> <th>type of read_data</th> <th>data_count</th> <th>actual number of 16-bit register read</th> </tr> </thead> <tbody> <tr> <td>char (8-bit)</td> <td>1</td> <td>1</td> </tr> <tr> <td>char (8-bit)</td> <td>2</td> <td>1</td> </tr> </tbody> </table> <p>1 WORD register(16-bit) equals to the size of 2 ASCII characters. According to the above table, reading 2 ASCII characters is actually reading the content of one 16-bit register.</p>	type of read_data	data_count	actual number of 16-bit register read	char (8-bit)	1	1	char (8-bit)	2	1
type of read_data	data_count	actual number of 16-bit register read								
char (8-bit)	1	1								
char (8-bit)	2	1								
Example	<pre>macro_command main() char str1[20] // read 10 words from LW-0~LW-9 to the variables str1[0] to str1[19] // since that 1 word can store 2 ASCII characters, reading 20 ASCII // characters is actually reading 10 words of register StringGet(str1[0], "Local HMI", LW, 0, 20) end macro_command</pre>									

Name	StringGetEx
Syntax	StringGetEx (<i>read_data</i> [start], <i>device_name</i> , <i>device_type</i> , <i>address_offset</i> , <i>data_count</i>)
Description	<p>Receives data from the PLC and continue executing next command even if no response from this device.</p> <p>Descriptions of <i>read_data</i>, <i>device_name</i>, <i>device_type</i>, <i>address_offset</i> and <i>data_count</i> are the same as GetData.</p>
Example	<pre>macro_command main() char str1[20] short test=0 // macro will continue executing test = 1 even if the MODBUS device is // not responding StringGetEx(str1[0], "MODBUS RTU", 4x, 0, 20) test = 1 // macro will not continue executing test = 2 until MODBUS device responds StringGet(str1[0], "MODBUS RTU", 4x, 0, 20) test = 2 end macro_command</pre>

Name	StringSet									
Syntax	StringSet(<i>send_data[start]</i> , <i>device_name</i> , <i>device_type</i> , <i>address_offset</i> , <i>data_count</i>)									
Description	<p>Send data to the PLC. Data is defined in <i>send_data[start]</i>~<i>send_data[start + data_count - 1]</i>. <i>send_data</i> must be a one-dimensional char array. <i>data_count</i> is the number of sent characters, it can be either a constant or a variable.</p> <p><i>device_name</i> is the PLC name enclosed in the double quotation marks (“”) and this name has been defined in the device list of system parameters.</p> <p><i>device_type</i> is the device type and encoding method (binary or BCD) of the PLC data. For example, if <i>device_type</i> is LW_BIN, it means the register is LW and the encoding method is binary. If use BIN encoding method, “_BIN” can be ignored. If <i>device_type</i> is LW_BCD, it means the register is LW and the encoding method is BCD.</p> <p><i>address_offset</i> is the address offset in the PLC.</p> <p>For example, StringSet(read_data_1[0], “FATEK KB Series”, RT, 5, 1) represents that the address offset is 5.</p> <p>If <i>address_offset</i> uses the format – “N#AAAAA”, N indicates that PLC’s station number is N. AAAAA represents the address offset. This format is used while multiple PLCs or controllers are connected to a single serial port. For example, StringSet(read_data_1[0], “FATEK KB Series”, RT, 2#5, 1) represents that the PLC’s station number is 2. If SetData () uses the default station number defined in the device list, it is not necessary to define station number in <i>address_offset</i>.</p> <p>The number of registers actually sends to depends on the value of the number of <i>data_count</i>, since that <i>send_data</i> is restricted to char array.</p> <table border="1" data-bbox="365 1272 1318 1453"> <thead> <tr> <th>type of read_data</th> <th>data_count</th> <th>actual number of 16-bit register send</th> </tr> </thead> <tbody> <tr> <td>char (8-bit)</td> <td>1</td> <td>1</td> </tr> <tr> <td>char (8-bit)</td> <td>2</td> <td>1</td> </tr> </tbody> </table> <p>1 WORD register(16-bit) equals to the size of 2 ASCII characters. According to the above table, sending 2 ASCII characters is actually writing to one 16-bit register. The ASCII characters are stored into the WORD register from low byte to high byte. While using the ASCII Display object to display the string data stored in the registers, <i>data_count</i> must be a multiple of 2 in order to display full string content. For example:</p> <pre data-bbox="365 1783 1410 1942">macro_command main() char src1[10]="abcde" StringSet(src1[0], "Local HMI", LW, 0, 5) end macro_command</pre>	type of read_data	data_count	actual number of 16-bit register send	char (8-bit)	1	1	char (8-bit)	2	1
type of read_data	data_count	actual number of 16-bit register send								
char (8-bit)	1	1								
char (8-bit)	2	1								

	<p>The ASCII Display object shows:</p> <div style="border: 1px solid black; padding: 2px; width: fit-content; margin: 5px 0;">abcd</div> <p>If <i>data_count</i> is an even number that is greater than or equal to the length of the string, the content of string can be completely shown:</p> <pre style="background-color: #f0f0f0; padding: 5px;">macro_command main() char src1[10]="abcde" StringSet(src1[0], "Local HMI", LW, 0, 6) end macro_command</pre> <div style="border: 1px solid black; padding: 2px; width: fit-content; margin: 5px 0;">abcde</div>
Example	<pre>macro_command main() char str1[10]="abcde" // Send 3 words to LW-0~LW-2 // Data are being sent until the end of string is reached. // Even though the value of data_count is larger than the length of string // , the function will automatically stop. StringSet(str1[0], "Local HMI", LW, 0, 10) end macro_command</pre>

Name	StringSetEx
Syntax	StringSetEx (<i>send_data</i> [start], <i>device_name</i> , <i>device_type</i> , <i>address_offset</i> , <i>data_count</i>)
Description	Send data to the PLC and continue executing next command even if no response from this device. Descriptions of <i>send_data</i> , <i>device_name</i> , <i>device_type</i> , <i>address_offset</i> and <i>data_count</i> are the same as StringSet.
Example	<pre>macro_command main() char str1[20]="abcde" short test=0 // macro will continue executing test = 1 even if the MODBUS device is // not responding StringSetEx(str1[0], "MODBUS RTU", 4x, 0, 20) test = 1 // macro will not continue executing test = 2 until MODBUS device responds StringSet(str1[0], "MODBUS RTU", 4x, 0, 20) test = 2</pre>

	end macro_command
--	-------------------

Name	StringCopy
Syntax	success = StringCopy ("source", destination[start]) or success = StringCopy (source[start], destination[start])
Description	<p>Copy one string to another. This function copies a static string (which is enclosed in quotes) or a string that is stored in an array to the destination buffer.</p> <p>The source string parameter accepts both static string (in the form: "source") and char array (in the form: source[start]).</p> <p>destination[start] must be an one-dimensional char array.</p> <p>This function returns a Boolean indicating whether the process is successfully done or not. If successful, it returns true, otherwise it returns false. If the length of source string exceeds the max. size of destination buffer, it returns false and the content of destination remains the same.</p> <p>The success field is optional.</p>
Example	<pre>macro_command main() char src1[5]="abcde" char dest1[5] bool success1 success1 = StringCopy(src1[0], dest1[0]) // success1=true, dest1="abcde" char dest2[5] bool success2 success2 = StringCopy("12345", dest2[0]) // success2=true, dest2="12345" char src3[10]="abcdefghij" char dest3[5] bool success3 success3 = StringCopy(src3[0], dest3[0]) // success3=false, dest3 remains the same. char src4[10]="abcdefghij" char dest4[5] bool success4 success4 = StringCopy(src4[5], dest4[0]) // success4=true, dest4="fghij" end macro_command</pre>

Name	StringDecAsc2Bin
Syntax	<pre>success = StringDecAsc2Bin(source[start], destination) or success = StringDecAsc2Bin("source", destination)</pre>
Description	<p>This function converts a decimal string to an integer. It converts the decimal string in source parameter into an integer, and stores it in the destination variable.</p> <p>The source string parameter accepts both static string (in the form: "source") and char array (in the form: source[start]).</p> <p>Destination must be a variable, to store the result of conversion.</p> <p>This function returns a Boolean indicating whether the process is successfully done or not. If successful, it returns true, otherwise it returns false. If the source string contains characters other than '0' to '9', it returns false.</p> <p>The success field is optional.</p>
Example	<pre>macro_command main() char src1[5]="12345" int result1 bool success1 success1 = StringDecAsc2Bin(src1[0], result1) // success1=true, result1 is 12345 char result2 bool success2 success2 = StringDecAsc2Bin("32768", result2) // success2=true, but the result exceeds the data range of result2 char src3[2]="4b" char result3 bool success3 success3 = StringDecAsc2Bin (src3[0], result3) // success3=false, because src3 contains characters other than '0' to '9' end macro_command</pre>

Name	StringBin2DecAsc
Syntax	success = StringBin2DecAsc (source, destination[start])
Description	<p>This function converts an integer to a decimal string. It converts the integer in source parameter into a decimal string, and stores it in the destination buffer. Source can be either a constant or a variable.</p> <p>Destination must be an one-dimensional char array, to store the result of conversion.</p> <p>This function returns a Boolean indicating whether the process is successfully done or not. If successful, it returns true, otherwise it returns false. If the length of decimal string after conversion exceeds the size of destination buffer, it returns false.</p> <p>The success field is optional.</p>
Example	<pre>macro_command main() int src1 = 2147483647 char dest1[20] bool success1 success1 = StringBin2DecAsc(src1, dest1[0]) // success1=true, dest1="2147483647" short src2 = 0x3c char dest2[20] bool success2 success2 = StringBin2DecAsc(src2, dest2[0]) // success2=true, dest2="60" int src3 = 2147483647 char dest3[5] bool success3 success3 = StringBin2DecAsc(src3, dest3[0]) // success3=false, dest3 remains the same. end macro_command</pre>

Name	StringDecAsc2Float
Syntax	<pre>success = StringDecAsc2Float (source[start], destination) or success = StringDecAsc2Float ("source", destination)</pre>
Description	<p>This function converts a decimal string to floats. It converts the decimal string in source parameter into float, and stores it in the destination variable. The source string parameter accepts both static string (in the form: "source") and char array (in the form: source[start]).</p> <p>Destination must be a variable, to store the result of conversion.</p> <p>This function returns a Boolean indicating whether the process is successfully done or not. If successful, it returns true, otherwise it returns false. If the source string contains characters other than '0' to '9' or '.', it returns false. The success field is optional.</p>
Example	<pre>macro_command main() char src1[10]="12.345" float result1 bool success1 success1 = StringDecAsc2Float(src1[0], result1) // success1=true, result1 is 12.345 float result2 bool success2 success2 = StringDecAsc2Float("1.234567890", result2) // success2=true, but the result exceeds the data range of result2, which // might result in loss of precision char src3[2]="4b" float result3 bool success3 success3 = StringDecAsc2Float(src3[0], result3) // success3=false, because src3 contains characters other than '0' to '9' or // '.' end macro_command</pre>

Name	StringFloat2DecAsc
Syntax	success = StringFloat2DecAsc(source, destination[start])
Description	<p>This function converts a float to a decimal string. It converts the float in source parameter into a decimal string, and stores it in the destination buffer. Source can be either a constant or a variable.</p> <p>Destination must be an one-dimensional char array, to store the result of conversion.</p> <p>This function returns a Boolean indicating whether the process is successfully done or not. If successful, it returns true, otherwise it returns false. If the length of decimal string after conversion exceeds the size of destination buffer, it returns false.</p> <p>The success field is optional.</p>
Example	<pre>macro_command main() float src1 = 1.2345 char dest1[20] bool success1 success1 = StringFloat2DecAsc(src1, dest1[0]) // success1=true, dest1="1.2345" float src2 = 1.23456789 char dest2 [20] bool success2 success2 = StringFloat2DecAsc(src2, dest2 [0]) // success2=true, but it might lose precision float src3 = 1.2345 char dest3[5] bool success3 success3 = StringFloat2DecAsc(src3, dest3 [0]) // success3=false, dest3 remains the same. end macro_command</pre>

Name	StringHexAsc2Bin
Syntax	<pre>success = StringHexAsc2Bin (source[start], destination) or success = StringHexAsc2Bin ("source", destination)</pre>
Description	<p>This function converts a hexadecimal string to binary data. It converts the hexadecimal string in source parameter into binary data, and stores it in the destination variable.</p> <p>The source string parameter accepts both static string (in the form: "source") and char array (in the form: source[start]).</p> <p>Destination must be a variable, to store the result of conversion.</p> <p>This function returns a Boolean indicating whether the process is successfully done or not. If successful, it returns true, otherwise it returns false. If the source string contains characters other than '0' to '9', 'a' to 'f' or 'A' to 'F', it returns false.</p> <p>The success field is optional.</p>
Example	<pre>macro_command main() char src1[5]="0x3c" int result1 bool success1 success1 = StringHexAsc2Bin(src1[0], result1) // success1=true, result1 is 3c short result2 bool success2 success2 = StringDecAsc2Bin("1a2b3c4d", result2) // success2=true, result2=3c4d.The result exceeds the data range of // result2 char src3[2]="4g" char result3 bool success3 success3 = StringDecAsc2Bin (src3[0], result3) // success3=false, because src3 contains characters other than '0' to '9' // , 'a' to 'f' or 'A' to 'F' end macro_command</pre>

Name	StringBin2HexAsc
Syntax	success = StringBin2HexAsc (source, destination[start])
Description	<p>This function converts binary data to a hexadecimal string. It converts the binary data in source parameter into a hexadecimal string, and stores it in the destination buffer.</p> <p>Source can be either a constant or a variable.</p> <p>Destination must be an one-dimensional char array, to store the result of conversion.</p> <p>This function returns a Boolean indicating whether the process is successfully done or not. If successful, it returns true, otherwise it returns false. If the length of hexadecimal string after conversion exceeds the size of destination buffer, it returns false.</p> <p>The success field is optional.</p>
Example	<pre>macro_command main() int src1 = 20 char dest1[20] bool success1 success1 = StringBin2HexAsc(src1, dest1[0]) // success1=true, dest1="14" short src2 = 0x3c char dest2[20] bool success2 success2 = StringBin2HexAsc(src2, dest2[0]) // success2=true, dest2="3c" int src3 = 0x1a2b3c4d char dest3[6] bool success3 success3 = StringBin2HexAsc(src3, dest3[0]) // success3=false, dest3 remains the same. end macro_command</pre>

Name	StringMid
Syntax	<pre>success = StringMid (source[start], count, destination[start]) or success = StringMid ("string", start, count, destination[start])</pre>
Description	<p>Retrieve a character sequence from the specified offset of the source string and store it in the destination buffer.</p> <p>The source string parameter accepts both static string (in the form: "source") and char array (in the form: source[start]). For source[start], the start offset of the substring is specified by the index value. For static source string("source"), the second parameter(start) specifies the start offset of the substring.</p> <p>The count parameter specifies the length of substring being retrieved. Destination must be an one-dimensional char array, to store the retrieved substring.</p> <p>This function returns a Boolean indicating whether the process is successfully done or not. If successful, it returns true, otherwise it returns false. If the length of retrieved substring exceeds the size of destination buffer, it returns false.</p> <p>The success field is optional.</p>
Example	<pre>macro_command main() char src1[20]="abcdefghijklmnopqrst" char dest1[20] bool success1 success1 = StringMid(src1[5], 6, dest1[0]) // success1=true, dest1="fghijk" char src2[20]="abcdefghijklmnopqrst" char dest2[5] bool success2 success2 = StringMid(src2[5], 6, dest2[0]) // success2=false, dest2 remains the same. char dest3[20]="12345678901234567890" bool success3 success3 = StringMid("abcdefghijklmnopqrst", 5, 5, dest3[15]) // success3= true, dest3="123456789012345fghij" end macro_command</pre>

Name	StringLength
Syntax	length = StringLength (source[start]) or length = StringLength ("source")
Description	Obtain the length of a string. It returns the length of source string and stores it in the length field on the left-hand side of '=' operator. The source string parameter accepts both static string (in the form: "source") and char array (in the form: source[start]). The return value of this function indicates the length of the source string.
Example	<pre>macro_command main() char src1[20]="abcde" int length1 length1= StringLength(src1[0]) // length1=5 char src2[20]={'a', 'b', 'c', 'd', 'e'} int length2 length2= StringLength(src2[0]) // length2=20 char src3[20]="abcdefghij" int length3 length3= StringLength(src3 [2]) // length3=8 end macro_command</pre>

Name	StringCat
Syntax	<pre>success = StringCat (source[start], destination[start]) or success = StringCat ("source", destination[start])</pre>
Description	<p>This function appends source string to destination string. It adds the contents of source string to the last of the contents of destination string.</p> <p>The source string parameter accepts both static string (in the form: "source") and char array (in the form: source[start]).</p> <p>Destination must be an one-dimensional char array.</p> <p>This function returns a Boolean indicating whether the process is successfully done or not. If successful, it returns true, otherwise it returns false. If the length of result string after concatenation exceeds the max. size of destination buffer, it returns false.</p> <p>The success field is optional.</p>
Example	<pre>macro_command main() char src1[20]="abcdefghij" char dest1[20]="1234567890" bool success1 success1= StringCat(src1[0], dest1[0]) // success1=true, dest1="123456790abcdefghij" char dest2 [10]="1234567890" bool success2 success2= StringCat("abcde", dest2 [0]) // success2=false, dest2 remains the same. char src3[20]="abcdefghij" char dest3[20] bool success3 success3= StringCat(src3[0], dest3[15]) // success3=false, dest3 remains the same. end macro_command</pre>

Name	StringCompare
Syntax	<pre>ret = StringCompare (str1[start], str2[start]) ret = StringCompare ("string1", str2[start]) ret = StringCompare (str1[start], "string2") ret = StringCompare ("string1", "string2")</pre>
Description	<p>Do a case-sensitive comparison of two strings.</p> <p>The two string parameters accept both static string (in the form: "string1") and char array (in the form: str1[start]).</p> <p>This function returns a Boolean indicating the result of comparison. If two strings are identical, it returns true. Otherwise it returns false.</p> <p>The ret field is optional.</p>
Example	<pre>macro_command main() char a1[20]="abcde" char b1[20]="ABCDE" bool ret1 ret1= StringCompare(a1[0], b1[0]) // ret1=false char a2[20]="abcde" char b2[20]="abcde" bool ret2 ret2= StringCompare(a2[0], b2[0]) // ret2=true char a3 [20]="abcde" char b3[20]="abcdefg" bool ret3 ret3= StringCompare(a3[0], b3[0]) // ret3=false end macro_command</pre>

Name	StringCompareNoCase
Syntax	<pre>ret = StringCompareNoCase(str1[start], str2[start]) ret = StringCompareNoCase("string1", str2[start]) ret = StringCompareNoCase(str1[start], "string2") ret = StringCompareNoCase("string1", "string2")</pre>
Description	<p>Do a case-insensitive comparison of two strings.</p> <p>The two string parameters accept both static string (in the form: "string1") and char array (in the form: str1[start]).</p> <p>This function returns a Boolean indicating the result of comparison. If two strings are identical, it returns true. Otherwise it returns false.</p> <p>The ret field is optional.</p>
Example	<pre>macro_command main() char a1[20]="abcde" char b1[20]="ABCDE" bool ret1 ret1= StringCompareNoCase(a1[0], b1[0]) // ret1=true char a2[20]="abcde" char b2[20]="abcde" bool ret2 ret2= StringCompareNoCase(a2[0], b2[0]) // ret2=true char a3 [20]="abcde" char b3[20]="abcdefg" bool ret3 ret3= StringCompareNoCase(a3[0], b3[0]) // ret3=false end macro_command</pre>

Name	StringFind
Syntax	<pre>position = StringFind (source[start], target[start]) position = StringFind ("source", target[start]) position = StringFind (source[start], "target") position = StringFind ("source", "target")</pre>
Description	<p>Return the position of the first occurrence of target string in the source string. The two string parameters accept both static string (in the form: "source") and char array (in the form: source[start]).</p> <p>This function returns the zero-based index of the first character of substring in the source string that matches the target string. Notice that the entire sequence of characters to find must be matched. If there is no matched substring, it returns -1.</p>
Example	<pre>macro_command main() char src1[20]="abcde" char target1[20]="cd" bool pos1 pos1= StringFind(src1[0], target1[0]) // pos1=2 char target2[20]="ce" bool pos2 pos2= StringFind("abcde", target2[0]) // pos2=-1 char src3[20]="abcde" bool pos3 pos3= StringFind(src3[3], "cd") // pos3=-1 end macro_command</pre>

Name	StringReverseFind
Syntax	<pre>position = StringReverseFind (source[start], target[start]) position = StringReverseFind ("source", target[start]) position = StringReverseFind (source[start], "target") position = StringReverseFind ("source", "target")</pre>
Description	<p>Return the position of the last occurrence of target string in the source string. The two string parameters accept both static string (in the form: "source") and char array (in the form: source[start]).</p> <p>This function returns the zero-based index of the first character of substring in the source string that matches the target string. Notice that the entire sequence of characters to find must be matched. If there exists multiple substrings that matches the target string, function will return the position of the last matched substring. If there is no matched substring, it returns -1.</p>
Example	<pre>macro_command main() char src1[20]="abcdeabcde" char target1[20]="cd" bool pos1 pos1= StringReverseFind(src1[0], target1[0]) // pos1=7 char target2[20]="ce" bool pos2 pos2= StringReverseFind("abcdeabcde", target2[0]) // pos2=-1 char src3[20]="abcdeabcde" bool pos3 pos3= StringReverseFind(src3[6], "ab") // pos3=-1 end macro_command</pre>

Name	StringFindOneOf
Syntax	<pre>position = StringFindOneOf (source[start], target[start]) position = StringFindOneOf ("source", target[start]) position = StringFindOneOf (source[start], "target") position = StringFindOneOf ("source", "target")</pre>
Description	<p>Return the position of the first character in the source string that matches any character contained in the target string.</p> <p>The two string parameters accept both static string (in the form: "source") and char array (in the form: source[start]).</p> <p>This function returns the zero-based index of the first character in the source string that is also in the target string. If there is no match, it returns -1.</p>
Example	<pre>macro_command main() char src1[20]="abcdeabcde" char target1[20]="sdf" bool pos1 pos1= StringFindOneOf(src1[0], target1[0]) // pos1=3 char src2[20]="abcdeabcde" bool pos2 pos2= StringFindOneOf(src2[1], "agi") // pos2=4 char target3 [20]="bus" bool pos3 pos3= StringFindOneOf("abcdeabcde", target3[1]) // pos3=-1 end macro_command</pre>

Name	StringIncluding
Syntax	<pre> success = StringIncluding (source[start], set[start], destination[start]) success = StringIncluding ("source", set[start], destination[start]) success = StringIncluding (source[start], "set", destination[start]) success = StringIncluding ("source", "set", destination[start]) </pre>
Description	<p>Retrieve a substring of the source string that contains characters in the set string, beginning with the first character in the source string and ending when a character is found in the source string that is not in the target string.</p> <p>The source string and set string parameters accept both static string (in the form: "source") and char array (in the form: source[start]).</p> <p>This function returns a Boolean indicating whether the process is successfully done or not. If successful, it returns true, otherwise it returns false. If the length of retrieved substring exceeds the size of destination buffer, it returns false.</p>
Example	<pre> macro_command main() char src1[20]="cabbageabc" char set1[20]="abc" char dest1[20] bool success1 success1 = StringIncluding(src1[0], set1[0], dest1[0]) // success1=true, dest1="cabba" char src2[20]="gecabba" char dest2[20] bool success2 success2 = StringIncluding(src2[0], "abc", dest2[0]) // success2=true, dest2="" char set3[20]="abc" char dest3[4] bool success3 success3 = StringIncluding("cabbage", set3[0], dest3[0]) // success3=false, dest3 remains the same. end macro_command </pre>

Name	StringExcluding
Syntax	<pre> success = StringExcluding (source[start], set[start], destination[start]) success = StringExcluding ("source", set[start], destination[start]) success = StringExcluding (source[start], "set", destination[start]) success = StringExcluding ("source", "set", destination[start]) </pre>
Description	<p>Retrieve a substring of the source string that contains characters that are not in the set string, beginning with the first character in the source string and ending when a character is found in the source string that is also in the target string. The source string and set string parameters accept both static string (in the form: "source") and char array (in the form: source[start]).</p> <p>This function returns a Boolean indicating whether the process is successfully done or not. If successful, it returns true, otherwise it returns false. If the length of retrieved substring exceeds the size of destination buffer, it returns false.</p>
Example	<pre> macro_command main() char src1[20]="cabbageabc" char set1[20]="ge" char dest1[20] bool success1 success1 = StringExcluding(src1[0], set1[0], dest1[0]) // success1=true, dest1="cabba" char src2[20]="cabbage" char dest2[20] bool success2 success2 = StringExcluding(src2[0], "abc", dest2[0]) // success2=true, dest2="" char set3[20]="ge" char dest3[4] bool success3 success3 = StringExcluding("cabbage", set3[0], dest3[0]) // success3=false, dest3 remains the same. end macro_command </pre>

Name	StringToUpper
Syntax	<pre>success = StringToUpper (source[start], destination[start]) success = StringToUpper ("source", destination[start])</pre>
Description	<p>Convert all the characters in the source string to uppercase characters and store the result in the destination buffer.</p> <p>The source string parameter accepts both static string (in the form: "source") and char array (in the form: source[start]).</p> <p>This function returns a Boolean indicating whether the process is successfully done or not. If successful, it returns true, otherwise it returns false. If the length of result string after conversion exceeds the size of destination buffer, it returns false.</p>
Example	<pre>macro_command main() char src1[20]="aBcDe" char dest1[20] bool success1 success1 = StringToUpper(src1[0], dest1[0]) // success1=true, dest1="ABCDE" char dest2[4] bool success2 success2 = StringToUpper("aBcDe", dest2[0]) // success2=false, dest2 remains the same. end macro_command</pre>

Name	StringToLower
Syntax	<pre>success = StringToLower (source[start], destination[start]) success = StringToLower ("source", destination[start])</pre>
Description	<p>Convert all the characters in the source string to lowercase characters and store the result in the destination buffer.</p> <p>The source string parameter accepts both static string (in the form: "source") and char array (in the form: source[start]).</p> <p>This function returns a Boolean indicating whether the process is successfully done or not. If successful, it returns true, otherwise it returns false. If the length of result string after conversion exceeds the size of destination buffer, it returns false.</p>

Example	<pre>macro_command main() char src1[20]="aBcDe" char dest1[20] bool success1 success1 = StringToUpper(src1[0], dest1[0]) // success1=true, dest1="abcde" char dest2[4] bool success2 success2 = StringToUpper("aBcDe", dest2[0]) // success2=false, dest2 remains the same. end macro_command</pre>
----------------	---

Name	StringToReverse
Syntax	<pre>success = StringToReverse (source[start], destination[start]) success = StringToReverse ("source", destination[start])</pre>
Description	<p>Reverse the characters in the source string and store it in the destination buffer. The source string parameter accepts both static string (in the form: "source") and char array (in the form: source[start]).</p> <p>This function returns a Boolean indicating whether the process is successfully done or not. If successful, it returns true, otherwise it returns false. If the length of reversed string exceeds the size of destination buffer, it returns false.</p>
Example	<pre>macro_command main() char src1[20]="abcde" char dest1[20] bool success1 success1 = StringToUpper(src1[0], dest1[0]) // success1=true, dest1="edcba" char dest2[4] bool success2 success2 = StringToUpper("abcde", dest2[0]) // success2=false, dest2 remains the same. end macro_command</pre>

Name	StringTrimLeft
Syntax	<pre> success = StringTrimLeft (source[start], set[start], destination[start]) success = StringTrimLeft ("source", set[start], destination[start]) success = StringTrimLeft (source[start], "set", destination[start]) success = StringTrimLeft ("source", "set", destination[start]) </pre>
Description	<p>Trim the leading specified characters in the set buffer from the source string. The source string and set string parameters accept both static string (in the form: "source") and char array (in the form: source[start]).</p> <p>This function returns a Boolean indicating whether the process is successfully done or not. If successful, it returns true, otherwise it returns false. If the length of trimmed string exceeds the size of destination buffer, it returns false.</p>
Example	<pre> macro_command main() char src1[20]= "# *a*#bc" char set1[20]="# *" char dest1[20] bool success1 success1 = StringTrimLeft (src1[0], set1[0], dest1[0]) // success1=true, dest1="a*#bc" char set2[20]={'#', ' ', '*'} char dest2[4] success2 = StringTrimLeft ("# *a*#bc", set2[0], dest2[0]) // success2=false, dest2 remains the same. char src3[20]="abc *#" char dest3[20] bool success3 success3 = StringTrimLeft (src3[0], "# *", dest3[0]) // success3=true, dest3="abc *#" end macro_command </pre>

Name	StringTrimRight
Syntax	<pre> success = StringTrimRight (source[start], set[start], destination[start]) success = StringTrimRight ("source", set[start], destination[start]) success = StringTrimRight (source[start], "set", destination[start]) success = StringTrimRight ("source", "set", destination[start]) </pre>
Description	<p>Trim the trailing specified characters in the set buffer from the source string. The source string and set string parameters accept both static string (in the form: "source") and char array (in the form: source[start]).</p> <p>This function returns a Boolean indicating whether the process is successfully done or not. If successful, it returns true, otherwise it returns false. If the length of trimmed string exceeds the size of destination buffer, it returns false.</p>
Example	<pre> macro_command main() char src1[20]= "# *a*#bc# * " char set1[20]="# *" char dest1[20] bool success1 success1 = StringTrimRight(src1[0], set1[0], dest1[0]) // success1=true, dest1="# *a*#bc" char set2[20]={'#', ' ', '*'} char dest2[20] success2 = StringTrimRight("# *a*#bc", set2[0], dest2[0]) // success2=true, dest2="# *a*#bc" char src3[20]="ab**c *#" char dest3[4] bool success3 success3 = StringTrimRight(src3[0], "# *", dest3[0]) // success3=false, dest3 remains the same. end macro_command </pre>

Name	StringInsert
Syntax	<pre> success = StringInsert (pos, insert[start], destination[start]) success = StringInsert (pos, "insert", destination[start]) success = StringInsert (pos, insert[start], length, destination[start]) success = StringInsert (pos, "insert", length, destination[start]) </pre>
Description	<p>Insert a string in a specific location within the destination string content. The insert location is specified by the pos parameter.</p> <p>The insert string parameter accepts both static string (in the form: "source") and char array (in the form: source[start]).</p> <p>The number of characters to insert can be specified by the length parameter. This function returns a Boolean indicating whether the process is successfully done or not. If successful, it returns true, otherwise it returns false. If the length of string after insertion exceeds the size of destination buffer, it returns false.</p>
Example	<pre> macro_command main() char str1[20]="but the question is" char str2[10]=", that is" char dest[40]="to be or not to be" bool success success = StringInsert(18, str1[3], 13, dest[0]) // success=true, dest="to be or not to be the question" success = StringInsert(18, str2[0], dest[0]) // success=true, dest="to be or not to be, that is the question" success = StringInsert(0, "Hamlet:", dest[0]) // success=false, dest remains the same. end macro_command </pre>

Name	String2Unicode
Syntax	<pre> result = String2Unicode("source", destination[start]) </pre>
Description	<p>Convert all the characters in the source string to Unicode and store the result in the destination buffer. The length of result string after conversion will be stored to result.</p> <p>Source must be a constant but not a variable.</p>
Example	<pre> macro_command main() char dest[20] int result result = String2Unicode("abcde", dest[0]) // "result" will be set to 10. result = String2Unicode("abcdefghijklmno", dest[0]) // "result" will be set to 20. // "result" will be the length of converted Unicode string </pre>

	end macro_command
--	-------------------

18.7.7. Recipe Query Function

Name	RecipeGetData
Syntax	RecipeGetData(<i>destination, recipe_address, record_ID</i>)
Description	Get Recipe Data. The gained data will be stored in <i>destination</i> , and must be a variable. <i>recipe_address</i> consists of recipe name and item name: "recipe_name.item_name". <i>record_ID</i> specifies the ID number of the record in recipe being gained.
Example	<pre>macro_command main() int data=0 char str[20] int recordID bool result recordID = 0 result = RecipeGetData(data, "TypeA.item_weight", recordID) // From recipe "TypeA" get the data of the item "item_weight" in record 0. recordID = 1 result = RecipeGetData(str[0], "TypeB.item_name", recordID) // From recipe "TypeB" get the data of the item "item_name" in record 1. end macro_command</pre>

Name	RecipeQuery
Syntax	RecipeQuery (<i>SQL_command, destination</i>)
Description	Use SQL statement to query recipe data. The number of records of query result will be stored in the <i>destination</i> . This must be a variable. SQL command can be static string or char array. Example: RecipeQuery("SELECT * FROM TypeA", destination) or RecipeQuery(sql[0], destination) SQL statement must start with "SELECT * FROM" followed by recipe name and query condition.
Example	<pre>macro_command main() int total_row=0 char sql[100]="SELECT * FROM TypeB" short var bool result result = RecipeQuery("SELECT * FROM TypeA", total_row) // Query Recipe "TypeA". Store the number of records of query result in total_row.</pre>

	<pre> result = RecipeQuery(sql[0], total_row) // Query Recipe "TypeB". Store the number of records of query result in total_row. result = RecipeQuery("SELECT * FROM Recipe WHERE Item >%(var)", total_row) // Query "Recipe", where "Item" is larger than var. Store the number of records of query result in total_row. end macro_command </pre>
--	---

Name	RecipeQueryGetData
Syntax	RecipeQueryGetData (<i>destination, recipe_address, result_row_no</i>)
Description	Get the data in the query result obtained by RecipeQuery. This function must be called after calling RecipeQuery, and specify the same recipe name in <i>recipe_address</i> as RecipeQuery. <i>result_row_no</i> specifies the sequence row number in query result
Example	<pre> macro_command main() int data=0 int total_row=0 int row_number=0 bool result_query bool result_data result_query = RecipeQuery("SELECT * FROM TypeA", total_row) // Query Recipe "TypeA". Store the number of records of query result in total_row. if (result_query) then for row_number=0 to total_row-1 result_data = RecipeQueryGetData(data, "TypeA.item_weight", row_number) next row_number end if end macro_command </pre>

Name	RecipeQueryGetRecordID
Syntax	RecipeQueryGetRecordID (<i>destination, result_row_no</i>)
Description	Get the record ID numbers of those records gained by RecipeQuery. This function must be called after calling RecipeQuery. <i>result_row_no</i> specifies the sequence row number in query result, and write the obtained record ID to destination.
Example	<pre> macro_command main() int recordID=0 int total_row=0 int row_number=0 </pre>

	<pre> bool result_query bool result_id result_query = RecipeQuery("SELECT * FROM TypeA", total_row) // Query Recipe "TypeA". Store the number of records of query result in total_row. if (result_query) then for row_number=0 to total_row-1 result_id = RecipeQueryGetRecordID(recordID, row_number) next row_number end if end macro_command </pre>
--	--

Name	RecipeSetData
Syntax	RecipeSetData(<i>source</i> , <i>recipe address</i> , <i>record_ID</i>)
Description	Write data to recipe. If success, returns true, else, returns false. <i>recipe_address</i> consists of recipe name and item name: "recipe_name.item_name". <i>record_ID</i> specifies the ID number of the record in recipe being modified.
Example	<pre> macro_command main() int data=99 char str[20]="abc" int recordID bool result recordID = 0 result = RecipeSetData(data, "TypeA.item_weight", recordID) // set data to recipe "TypeA", where item name is "item_weight" and the record ID is 0. recordID = 1 result = RecipeSetData(str[0], "TypeB.item_name", recordID) // set data to recipe "TypeB", where item name is "item_name" and the record ID is 1. end macro_command </pre>

18.7.8. Miscellaneous

Name	Beep
Syntax	Beep ()
Description	Plays beep sound. This command plays a beep sound with frequency of 800 hertz and duration of 30 milliseconds.
Example	macro_command main()

	<pre>Beep() end macro_command</pre>
--	--------------------------------------

Name	Buzzer
Syntax	Buzzer ()
Description	Turn ON / OFF the buzzer.
Example	<pre>char on = 1, off = 0 Buzzer(on) // turn on the buzzer DELAY(1000) // delay 1 second Buzzer(off) // turn off the buzzer DELAY(500) // delay 500ms Buzzer(1) // turn on the buzzer DELAY(1000) // delay 1 second Buzzer(0) // turn off the buzzer</pre>

Name	SYNC_TRIG_MACRO
Syntax	SYNC_TRIG_MACRO(<i>macro_id or name</i>)
Description	<p>Trigger the execution of a macro synchronously (use <i>macro_id</i> or macro name to designate this macro) in a running macro.</p> <p>The current macro will pause until the end of execution of this called macro. <i>macro_id</i> can be a constant or a variable.</p>
Example	<pre>macro_command main() char ON = 1, OFF = 0 SetData(ON, "Local HMI", LB, 0, 1) SYNC_TRIG_MACRO(5)// call a macro (its ID is 5) SYNC_TRIG_MACRO("macro_1") // call a macro (its name is macro_1) SetData(OFF, "Local HMI", LB, 0, 1) end macro_command</pre>

Name	ASYNC_TRIG_MACRO
Syntax	ASYNC_TRIG_MACRO (<i>macro_id or name</i>)
Description	<p>Trigger the execution of a macro asynchronously (use <i>macro_id</i> or <i>macro name</i> to designate this macro) in a running macro.</p> <p>The current macro will continue executing the following instructions after triggering the designated macro; in other words, the two macros will be active simultaneously.</p> <p><i>macro_id</i> can be a constant or a variable.</p>
Example	<pre>macro_command main() char ON = 1, OFF = 0 SetData(ON, "Local HMI", LB, 0, 1) ASYNC_TRIG_MACRO(5)// call a macro (its ID is 5) ASYNC_TRIG_MACRO("macro_1") // call a macro (its name is macro_1) SetData(OFF, "Local HMI", LB, 0, 1) end macro_command</pre>

Name	TRACE
Syntax	TRACE(<i>format, argument</i>)
Description	<p>Use this function to send specified string to the EasyDiagnoser. Users can print out the current value of variables during run-time of macro for debugging.</p> <p>When TRACE encounters the first format specification (if any), it converts the value of the first argument after format and outputs it accordingly.</p> <p>format refers to the format control of output string. A format specification, which consists of optional (in []) and required fields (in bold), has the following form:</p> <p>%[flags] [width] [.precision] type</p> <p>Each field of the format specification is described as below:</p> <p><i>flags</i> (optional):</p> <ul style="list-style-type: none"> - + <p><i>width</i> (optional):</p> <p>A nonnegative decimal integer controlling the minimum number of characters printed.</p> <p><i>precision</i> (optional):</p> <p>A nonnegative decimal integer which specifies the precision and the number of characters to be printed.</p> <p><i>type</i>:</p> <ul style="list-style-type: none"> C or c : specifies a single-byte character. d : signed decimal integer. i : signed decimal integer. o : unsigned octal integer. u : unsigned decimal integer.

	<p>X or x : unsigned hexadecimal integer. E or e : Signed value having the form. [-]d.dddd e [sign]ddd where d is a single decimal digit, dddd is one or more decimal digits, ddd is exactly three decimal digits, and sign is + or -. f : Signed value having the form [-]dddd.dddd,</p> <p>The length of output string is limited to 256 characters. The extra characters will be ignored. The <i>argument</i> part is optional. One format specification converts exactly one argument.</p>
Example	<pre>macro_command main() char c1 = 'a' short s1 = 32767 float f1 = 1.234567 TRACE("The results are") // output: The results are TRACE("c1 = %c, s1 = %d, f1 = %f", c1, s1, f1) // output: c1 = a, s1 = 32767, f1 = 1.234567 end macro_command</pre>

Name	FindDataSamplingDate
Syntax	return_value = FindDataSamplingDate (<i>data_log_number, index, year, month, day</i>) or FindDataSamplingDate (<i>data_log_number, index, year, month, day</i>)
Description	<p>A query function for finding the date of specified data sampling file according to the data sampling no. and the file index. The date is stored into year, month and day respectively in the format of YYYY, MM and DD.</p> <div data-bbox="395 1317 1337 1518" data-label="Image"> </div> <p>The directory of saved data: [Storage location]\[filename]\yyyymmdd.dtl. The data sampling files under the same directory are sorted according to the file name and are indexed starting from 0. The most recently saved file has the smallest file index number. For example, if there are four data sampling files as follows: 20101210.dtl 20101230.dtl 20110110.dtl 20110111.dtl The file index are: 20101210.dtl -> index is 3 20101230.dtl -> index is 2 20110110.dtl -> index is 1</p>

	<p>20110111.dtl -> index is 0 <i>return_value</i> equals to 1 if referred data sampling file is successfully found, otherwise it equals to 0. <i>data_log_number</i> and <i>index</i> can be constant or variable. <i>year</i>, <i>month</i>, <i>day</i> and <i>return_value</i> must be variable. <i>return_value</i> is optional.</p>
Example	<pre>macro_command main() short data_log_number = 1, index = 2, year, month, day short success // if there exists a data sampling file named 20101230.dtl, with data sampling // // number 1 and file index 2. // the result after execution: success == 1, year == 2010, month == 12 and //day // == 30 success = FindDataSamplingDate(data_log_number, index, year, month, day) end macro_command</pre>

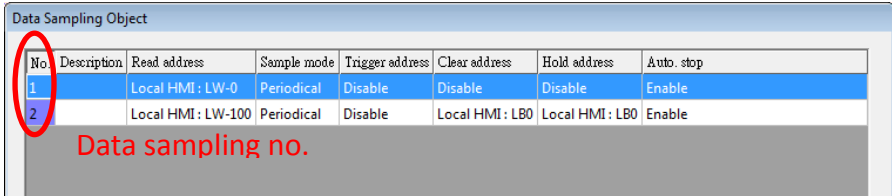
Name	FindDataSamplingIndex
Syntax	<p><i>return_value</i> = FindDataSamplingIndex (<i>data_log_number</i>, <i>year</i>, <i>month</i>, <i>day</i>, <i>index</i>) or FindDataSamplingIndex (<i>data_log_number</i>, <i>year</i>, <i>month</i>, <i>day</i>, <i>index</i>)</p>
Description	<p>A query function for finding the file index of specified data sampling file according to the data sampling no. and the date. The file index is stored into <i>index</i>. <i>year</i>, <i>month</i> and <i>day</i> are in the format of YYYY, MM and DD respectively.</p>  <p>The directory of saved data: [Storage location]\[filename]\yyyymmdd.dtl. The data sampling files under the same directory are sorted according to the file name and are indexed starting from 0. The most recently saved file has the smallest file index number. For example, if there are four data sampling files as follows: 20101210.dtl 20101230.dtl 20110110.dtl 20110111.dtl The file index are: 20101210.dtl -> index is 3 20101230.dtl -> index is 2 20110110.dtl -> index is 1 20110111.dtl -> index is 0 <i>return_value</i> equals to 1 if referred data sampling file is successfully found, otherwise it equals to 0. <i>data_log_number</i>, <i>year</i>, <i>month</i> and <i>day</i> can be constant or variable. <i>index</i> and</p>

	<i>return_value</i> must be variable. <i>return_value</i> is optional.
Example	<pre>macro_command main() short data_log_number = 1, year = 2010, month = 12, day = 10, index short success // if there exists a data sampling file named 20101210.dtl, with data sampling // // number 1 and file index 2. // the result after execution: success == 1 and index == 2 success = FindDataSamplingIndex (data_log_number, year, month, day, index) end macro_command</pre>

Name	FindEventLogDate
Syntax	<pre>return_value = FindEventLogDate (<i>index, year, month, day</i>) or FindEventLogDate (<i>index, year, month, day</i>)</pre>
Description	<p>A query function for finding the date of specified event log file according to file index. The date is stored into year, month and day respectively in the format of YYYY, MM and DD.</p> <p>The event log files stored in the designated position (such as HMI memory storage or external memory device) are sorted according to the file name and are indexed starting from 0. The most recently saved file has the smallest file index number. For example, if there are four event log files as follows:</p> <pre>EL_20101210.evt EL_20101230.evt EL_20110110.evt EL_20110111.evt</pre> <p>The file index are:</p> <pre>EL_20101210.evt -> index is 3 EL_20101230.evt -> index is 2 EL_20110110.evt -> index is 1 EL_20110111.evt -> index is 0</pre> <p><i>return_value</i> equals to 1 if referred data sampling file is successfully found, otherwise it equals to 0.</p> <p><i>index</i> can be constant or variable. <i>year, month, day</i> and <i>return_value</i> must be variable. <i>return_value</i> is optional.</p>
Example	<pre>macro_command main() short index = 1, year, month, day short success // if there exists an event log file named EL_20101230.evt , with index 1 // the result after execution: success == 1, year == 2010, month == 12, day //== 30 success = FindEventLogDate (index, year, month, day) end macro_command</pre>

Name	FindEventLogIndex
Syntax	return_value = FindEventLogIndex (<i>year, month, day, index</i>) or FindEventLogIndex (<i>year, month, day, index</i>)
Description	<p>A query function for finding the file index of specified event log file according to date. The file index is stored into index. year, month and day are in the format of YYYY, MM and DD respectively.</p> <p>The event log files stored in the designated position (such as HMI memory storage or external memory device) are sorted according to the file name and are indexed starting from 0. The most recently saved file has the smallest file index number. For example, if there are four event log files as follows:</p> <p>EL_20101210.evt EL_20101230.evt EL_20110110.evt EL_20110111.evt</p> <p>The file index are:</p> <p>EL_20101210.evt -> index is 3 EL_20101230.evt -> index is 2 EL_20110110.evt -> index is 1 EL_20110111.evt -> index is 0</p> <p><i>return_value</i> equals to 1 if referred data sampling file is successfully found, otherwise it equals to 0.</p> <p><i>index</i> can be constant or variable. <i>year, month, day</i> and <i>return_value</i> must be variable. <i>return_value</i> is optional.</p>
Example	<pre>macro_command main() short year = 2010, month = 12, day = 10, index short success // if there exists an event log file named EL_20101210.evt, with index 2 // the result after execution: success == 1, index == 2 success = FindEventLogIndex (year, month, day, index) end macro_command</pre>

18.8. How to Create and Execute a Macro

18.8.1. How to Create a Macro

Please follow the steps below to create a macro.

1. Click on  [Macro Manager] icon on the tool bar in EasyBuilder Pro to open Macro Manager dialog box as follows.

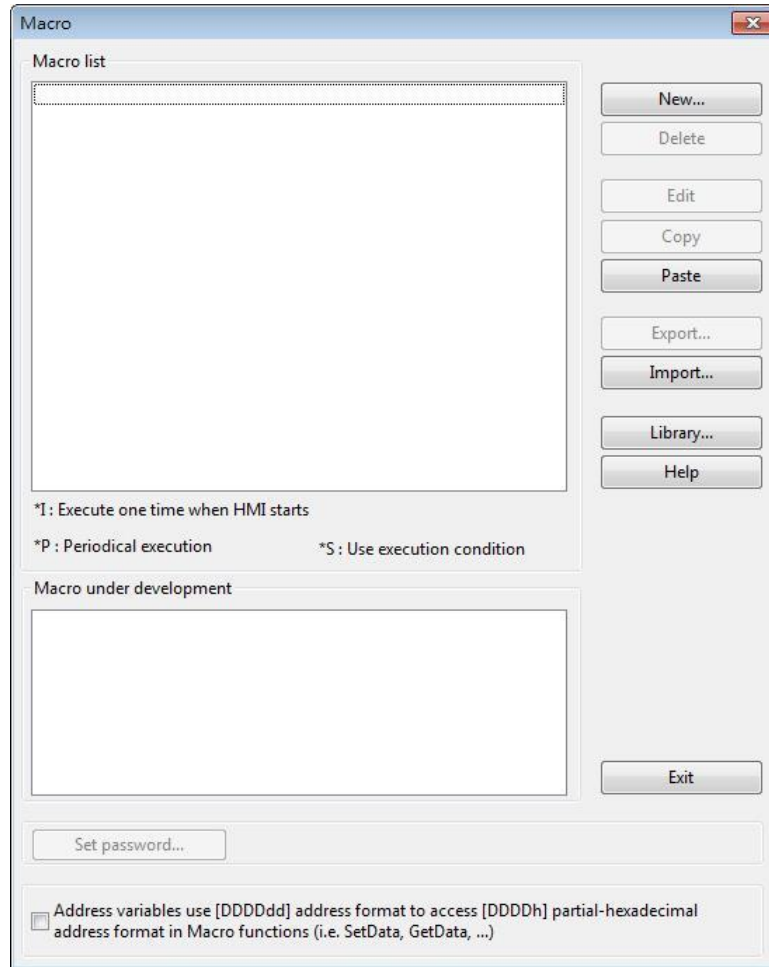

In Macro Manager, all macros compiled successfully are displayed in “Macro list”, and all macros under development or cannot be compiled are displayed in “Macro under development”. The following is a description of the various buttons.

Setting	Description
New	Opens a blank “WorkSpace” editor for creating a new macro.
Delete	Deletes the selected macro.
Edit	Opens the “WorkSpace” editor, and loads the selected macro.
Copy	Copies the selected macro into the clipboard.
Paste	Pastes the macro in the clipboard into the list, and creates a new name for the macro.
Export	Save the selected macro as *.edm file.
Import	Import an *.edm file to the project.
Library	Open Macro Function Library managing dialog.

- Press the [New] button to create an empty macro and open the macro editor. Every macro has a unique number defined at [Macro ID], and must have a macro name, otherwise an error will appear while compiling.

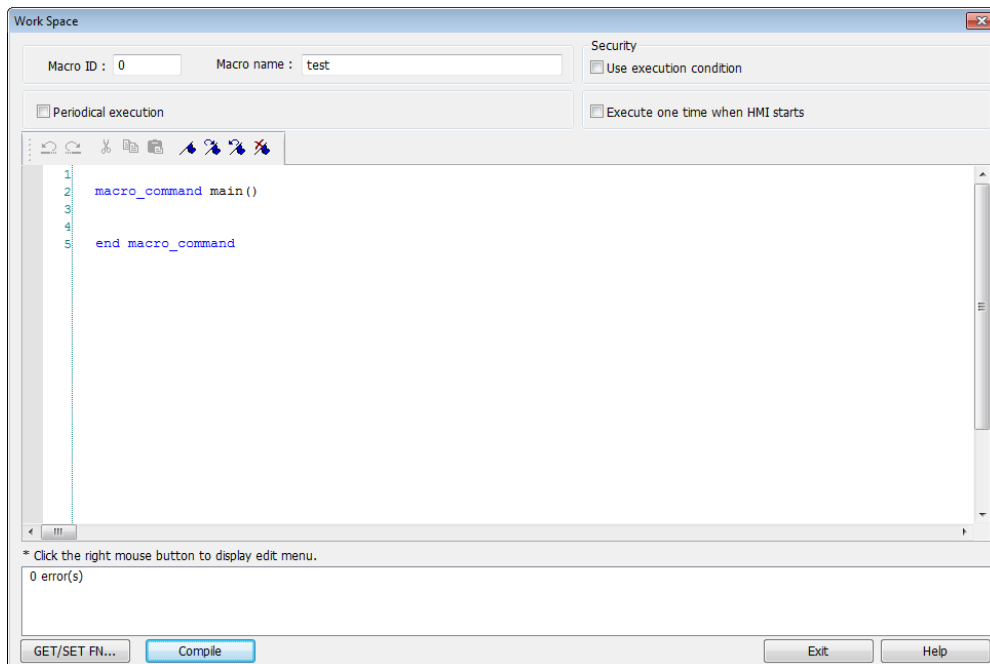

- Design your macro. To use built-in functions (like SetData() or Getdata()), press [Get/Set FN...] button to open API dialog box and select the function and set essential parameters.

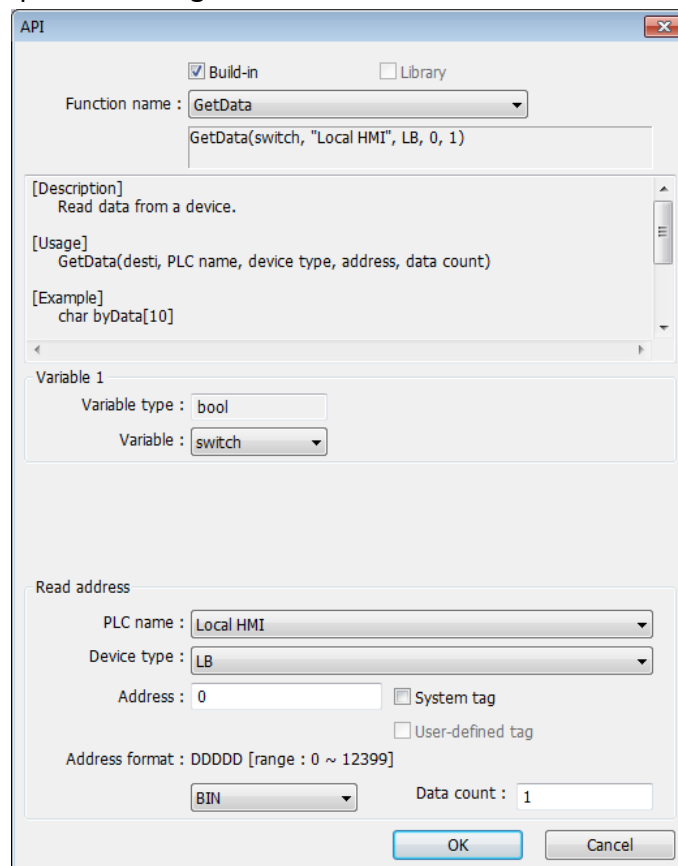

4. After the completion of a new macro, press [Compile] button to compile the macro.

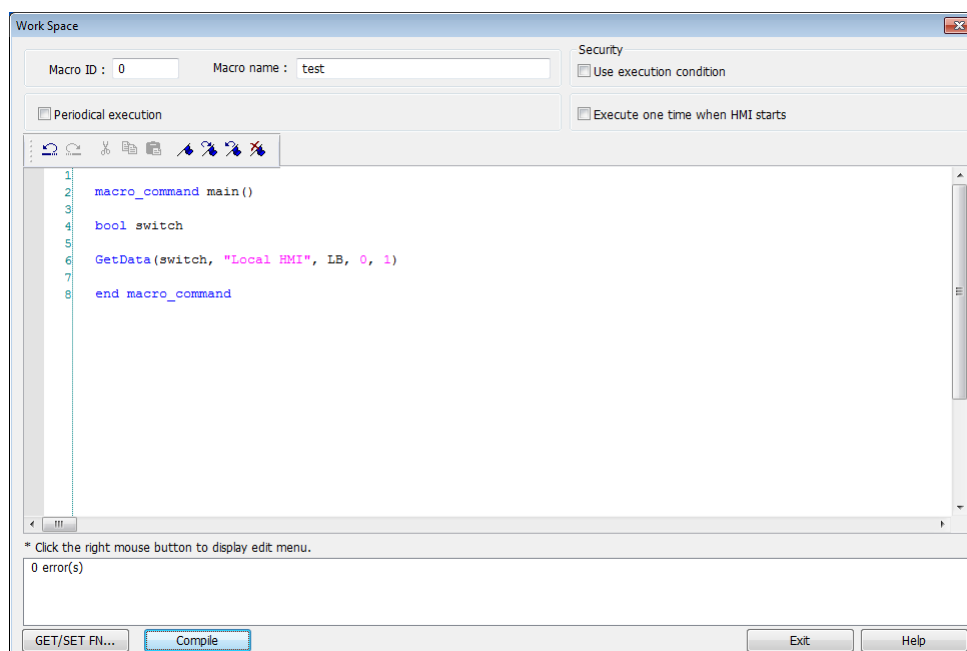

5. If there is no error, press [Exit] button and a new macro "macro_test" will be in "Macro list".

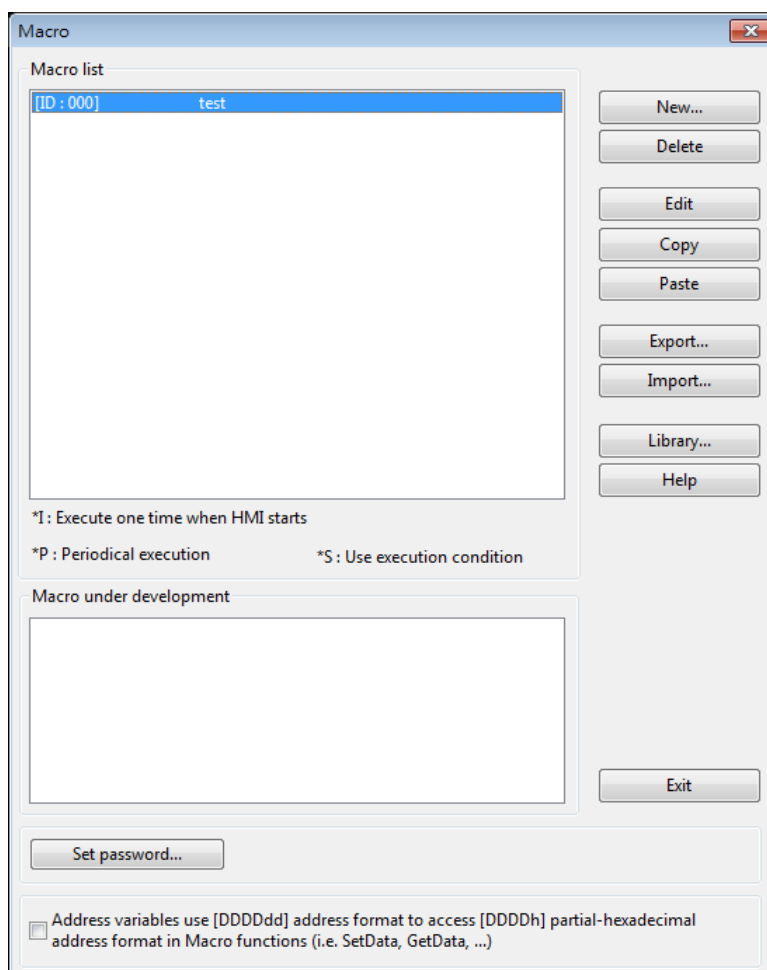

18.8.2. Execute a Macro

There are several ways to execute a macro.

- Use a PLC Control object
 1. Open [PLC Control] and add one PLC Control object with the [Type of control] as [Execute macro program].
 2. Select the macro in [Macro name]. Choose a bit and select a trigger condition to trigger the macro. In order to guarantee that the macro will run only once, consider latching the trigger bit, and then resetting the trigger condition within the macro.
 3. Use a [Set Bit] or Toggle Switch object to change the bit to activate the macro.

- Use a [Set Bit] or Toggle Switch object
 1. On the [General] tab of the [Set Bit] or [Toggle Switch] dialog box, select the [Execute Macro] option.
 2. Select the macro to execute. The macro will be executed one time when the button is activated.

- Use a Function Key object
 1. On the [General] tab of the [Function Key] dialog, select the [Execute Macro] option.
 2. Select the macro to execute. The macro will execute one time when the button is activated.

- In macro editor, use
 1. [Periodical Execution]: Macro will be triggered periodically.
 2. [Execute one time when HMI starts]: Macro will be executed once HMI starts.

- In Window Settings, Macro group box
 1. [Open]: When the window opens, run the selected macro once.
 2. [Cycle]: When the window opens, run the selected macro every 0.5 second.
 3. [Close]: When the window closes, run the selected macro once.

18.9. User Defined Macro Function

When editing Macro, to save time of defining functions, user may search for the needed from built-in Macro Function Library. However, certain functions, though frequently used, may not be found there. In this case, user may define the needed function and save it for future use. Next time when the same function is required, the saved functions can be called from [Macro Function Library] for easier editing. Additionally, [Macro Function Library] greatly enhances the portability of user-defined functions. Before building a function please check the built-in

functions or online function library to see if it exists.

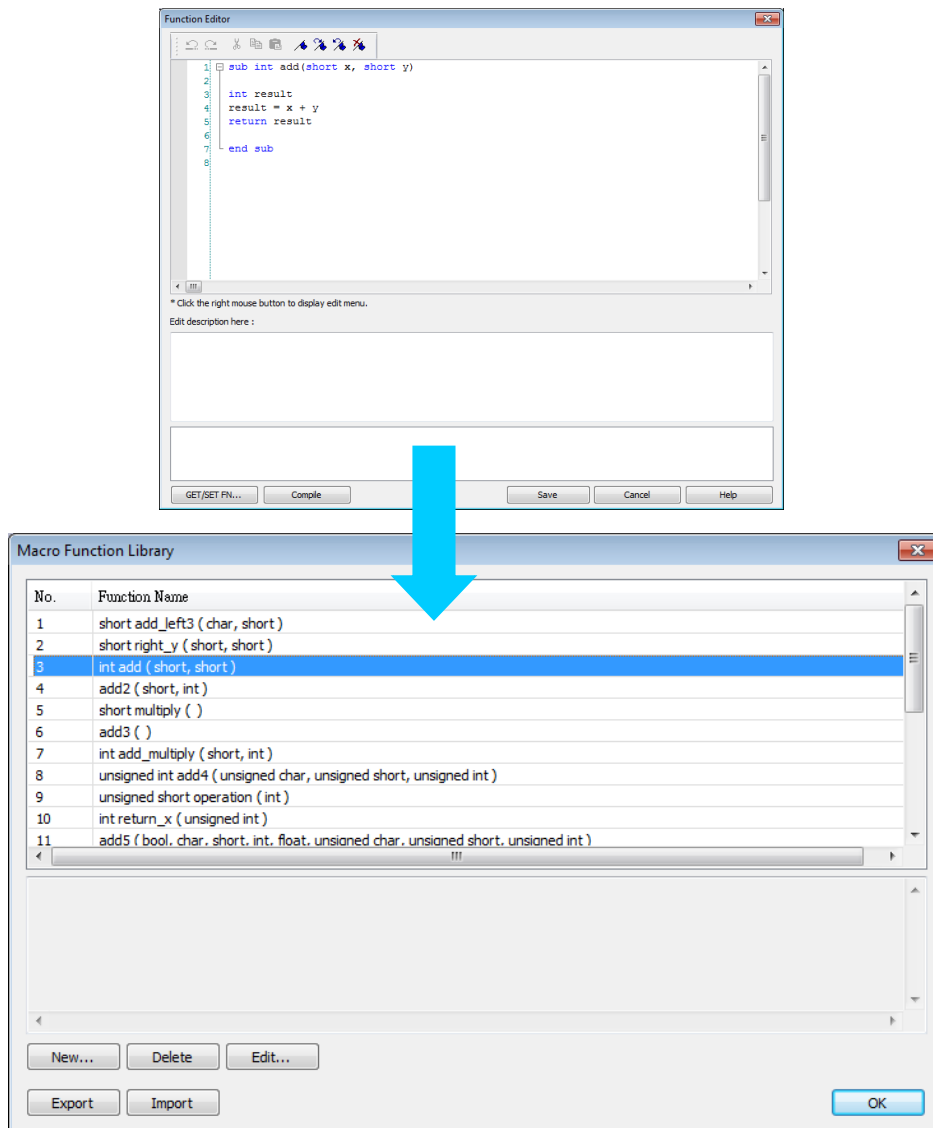

18.9.1. Import Function Library File

Open a project in HMI programming software, the default Function Library File will be read automatically and the function information will be loaded in. At this moment if a user-defined function is called, the relevant .mlb file must be imported first.

1. Default Function Library File Name: MacroLibrary (without filename extension)
2. Function Library Directory: HMI programming software installation directory\library (folder)
3. \library (folder) contains two types of function library files:

Without filename extension: MacroLibrary, the Default Function Library for HMI programming software to read at the beginning.

With filename extension (.mlb): Such as "math.mlb". The files to be read / written when users import / export. These files are portable and can be called from the folder when

needed.

4. When opening HMI programming software, only the functions in Default Function Library will be loaded in, to use functions in .mlb files, please import them first.

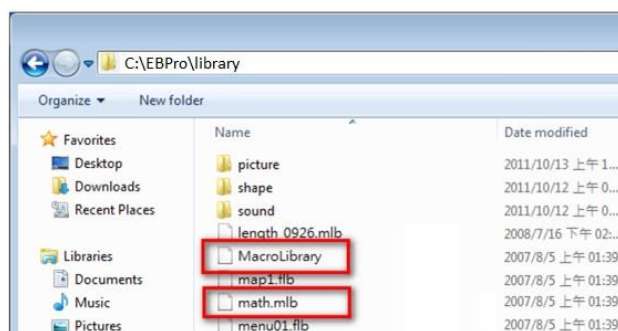

18.9.2. How to Use Macro Function Library

1. Select the function directly from Macro Function Library.

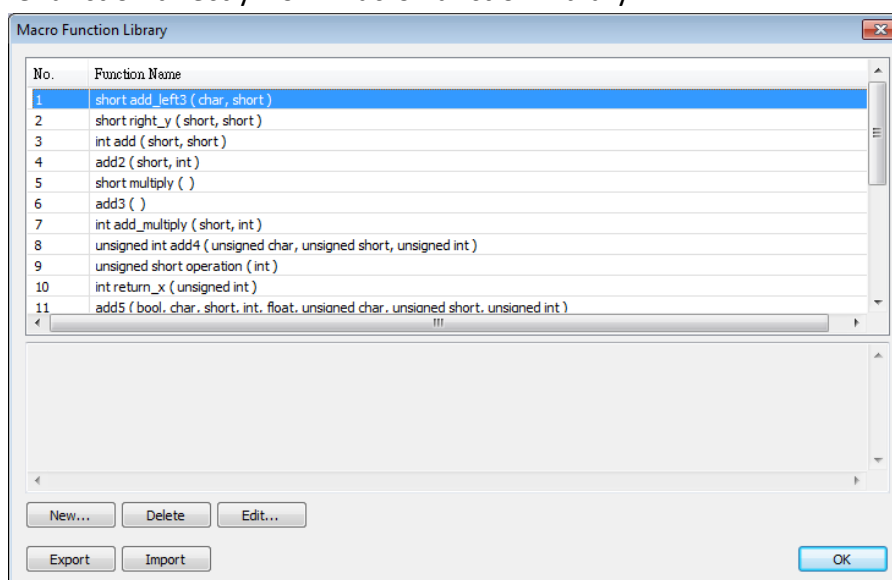

2. In WorkSpace click [GET/SET FN...] to open API dialog box.

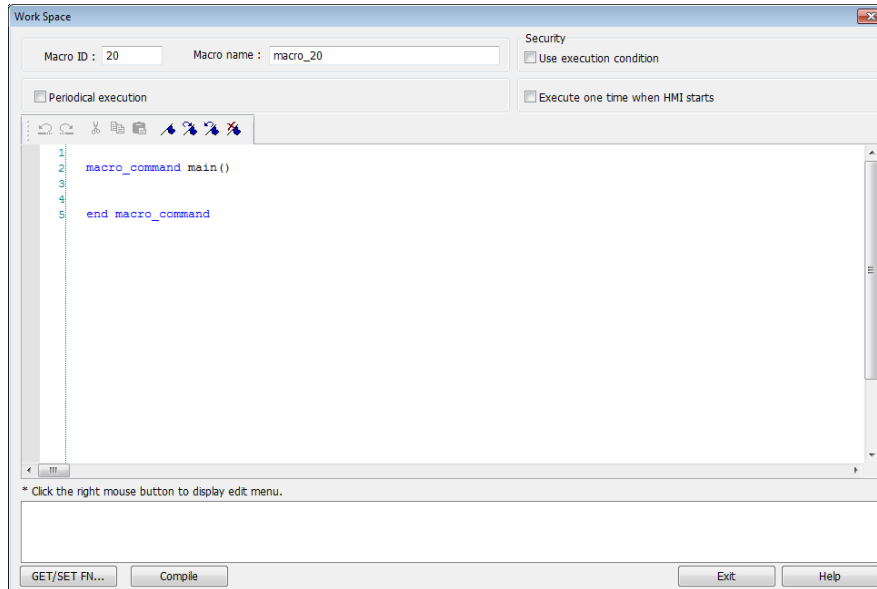

3. At least check one from [Library] or [Build-in] and select the function to be used.

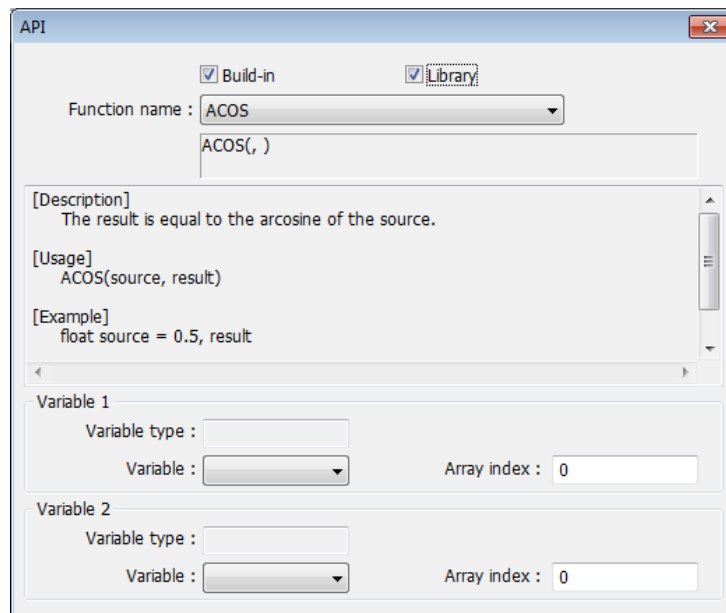

4. The description displayed in API dialog box is the same as written in Function Editor.

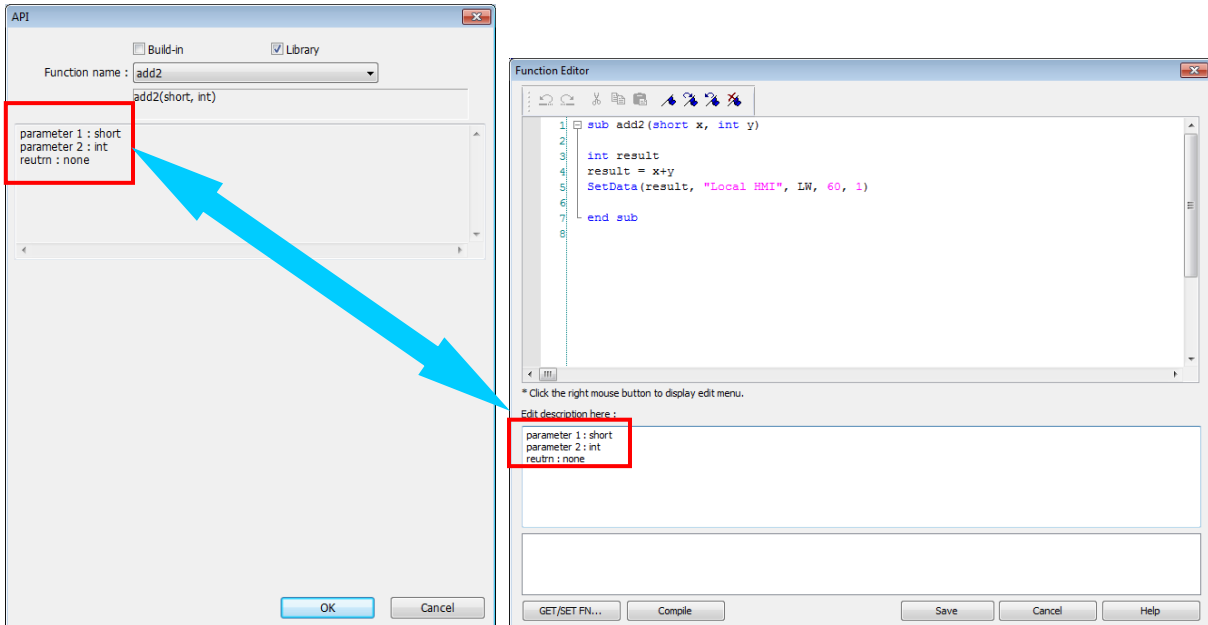

5. Select the function to be used, fill in the corresponding variables according to the data type.

<pre> 1 macro_command main() 2 3 4 short a 5 int b,result 6 7 add2(short, int) 8 9 end macro_command </pre>		<pre> 1 macro_command main() 2 3 4 short a 5 int b,result 6 7 result = add2(a, b) 8 9 end macro_command </pre>
--	--	---

6. Upon completion of the steps above, user-defined functions can be used freely without defining the same functions repeatedly.

18.9.3. Function Library Management Interface

1. Open macro management dialog, click [Library] to open [Macro Function Library] dialog box.

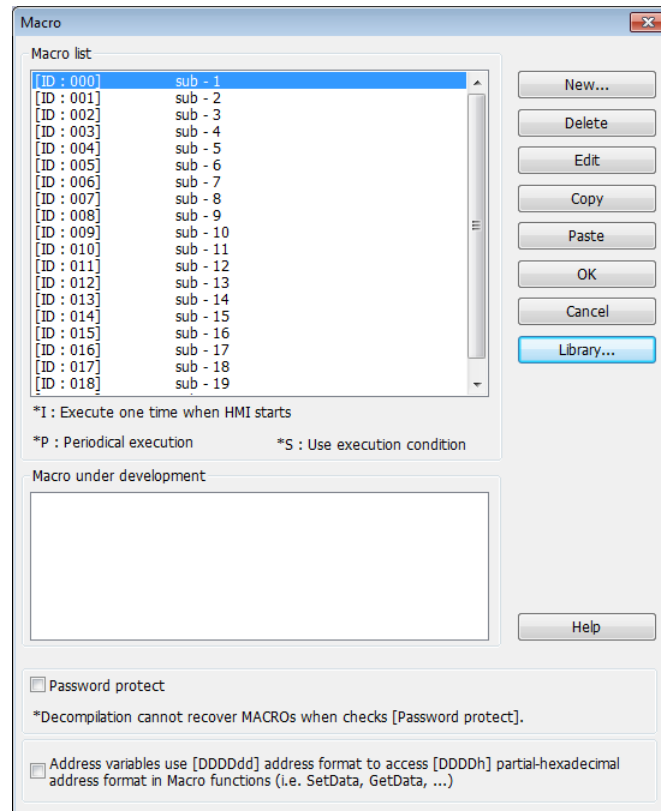

2. A list of functions is shown. When the project is opened, the software will load all the functions in the Macro Function Library.

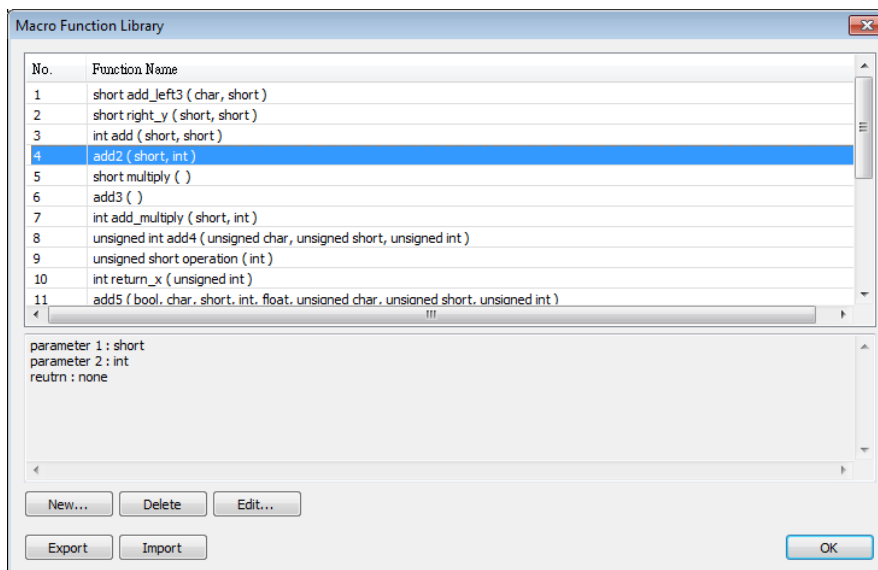

3. Each listed function has the following format:

return_type function_name (*parameter_type1*, ..., *parameter_typeN*)

return_type indicates the type of the return value. If this value does not exist, this column will be omitted. *function_name* indicates the name of the function. "N" in *parameter_typeN* stands for the number of parameter types. If this function does not

need any parameter, this column will be omitted.

```

1 sub int ADD(int a, int b)
2   int ret
3   ret = a+b
4   return ret
5 end sub
6

```

- Macro function can be embedded in the project file. Select the function and then click [Copy To Project], then you can find this function in [Project] tab. When opening the project on another computer, this function can still be used. When compiling the project, the .exob file will included the functions that are used. Please note that decompiling the project will only produce the macro commands that are used.

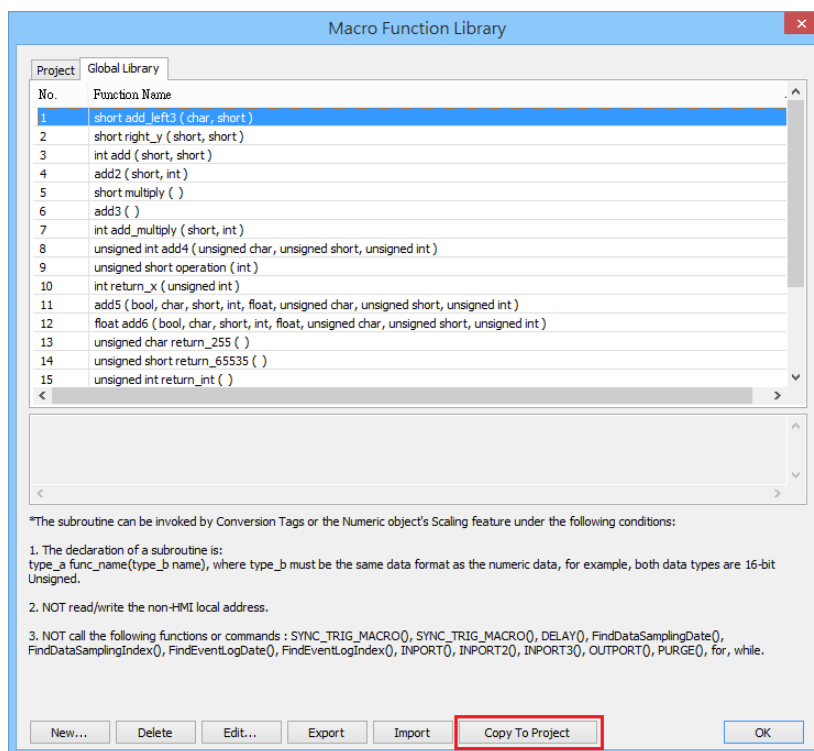

18.9.3.1. Create a Function

- Click [New] to enter Function Editor.

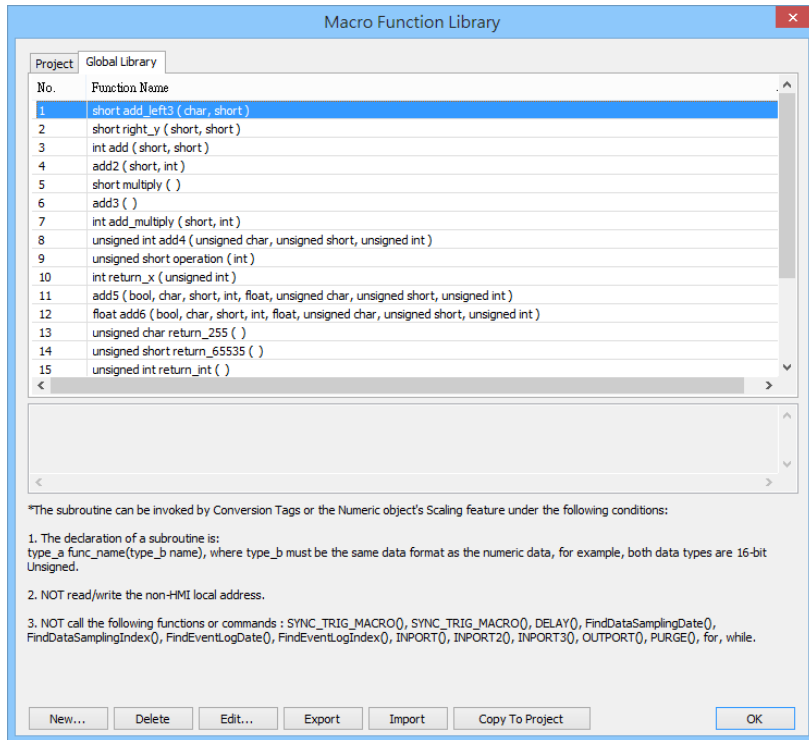

2. Edit function in Function Editor.

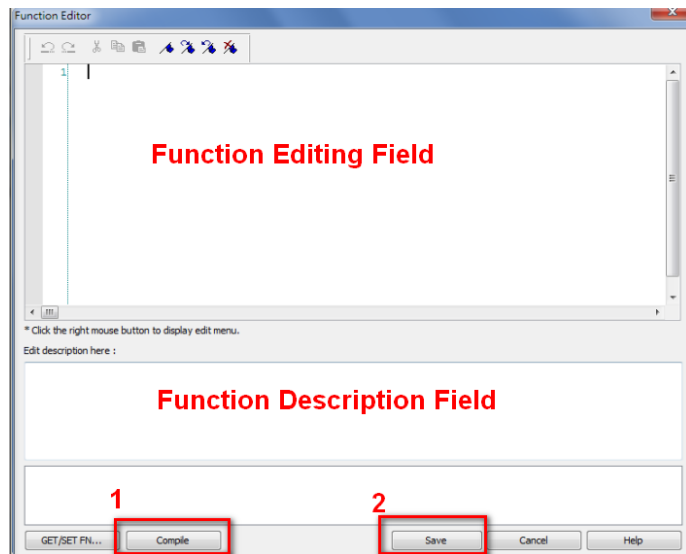

3. Edit the function description to describe what the specification is, how to use ... etc.
4. After editing, click [Compile] and [Save] to save this function to the Library. Otherwise, a warning is shown.

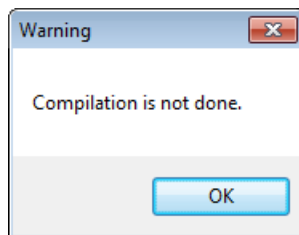

5. Successfully add a function into Macro Function Library.

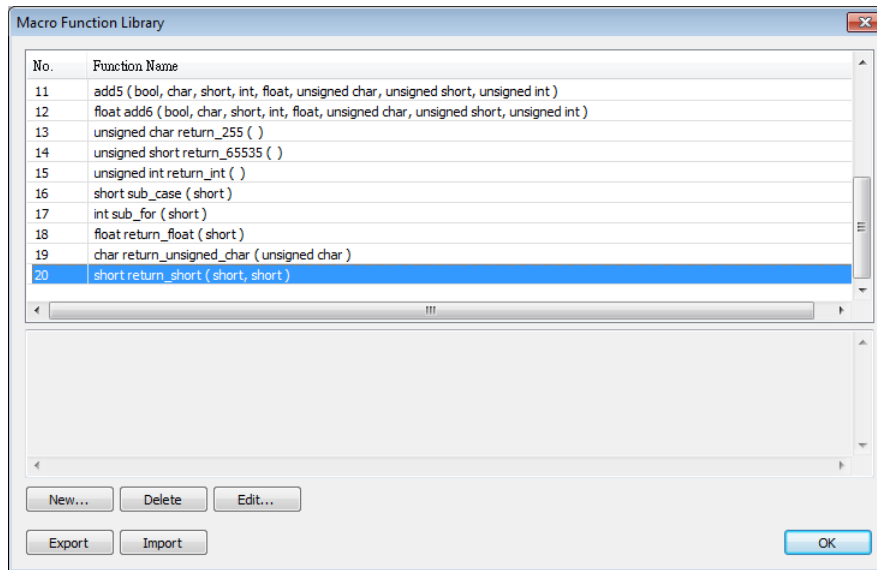

Note

- The total size of data type can be declared in a function is 4096 bytes.
- Function name must only contain alphanumeric characters, and cannot start with a number.

18.9.3.2. Delete a Function

1. In function list select the function to be deleted and click [Delete].

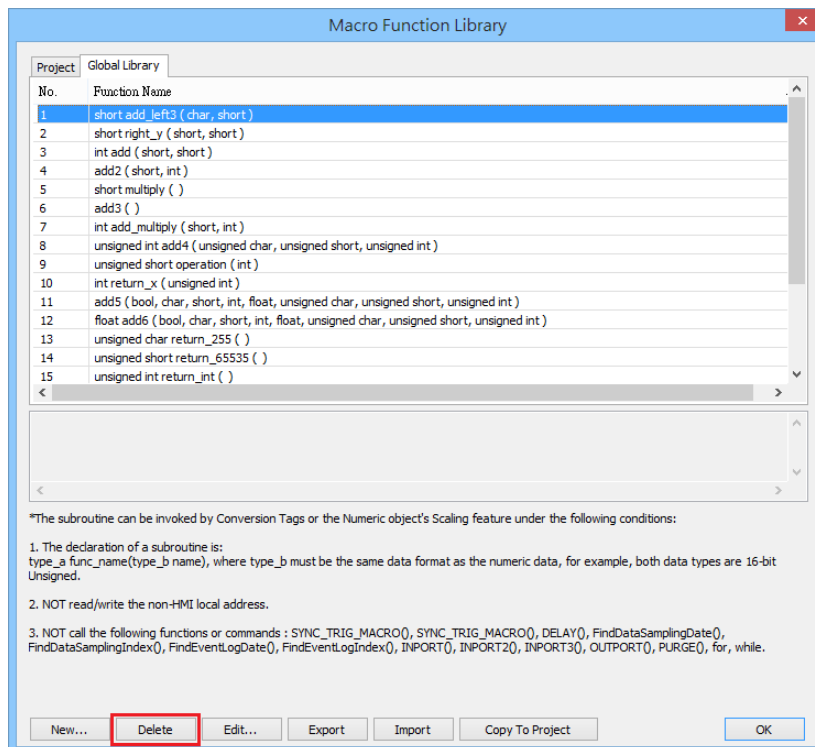

2. Click [Yes] to confirm, [No] to cancel the deletion. Click [Yes] to delete MAX_SHORT function.

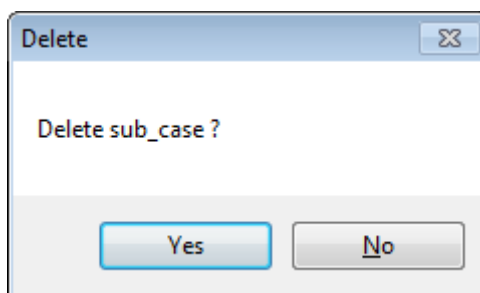

18.9.3.3. Modify a Function

1. Users can modify the functions exist in the Library.
2. Select a function to modify by clicking [Edit] to enter Function Editor.

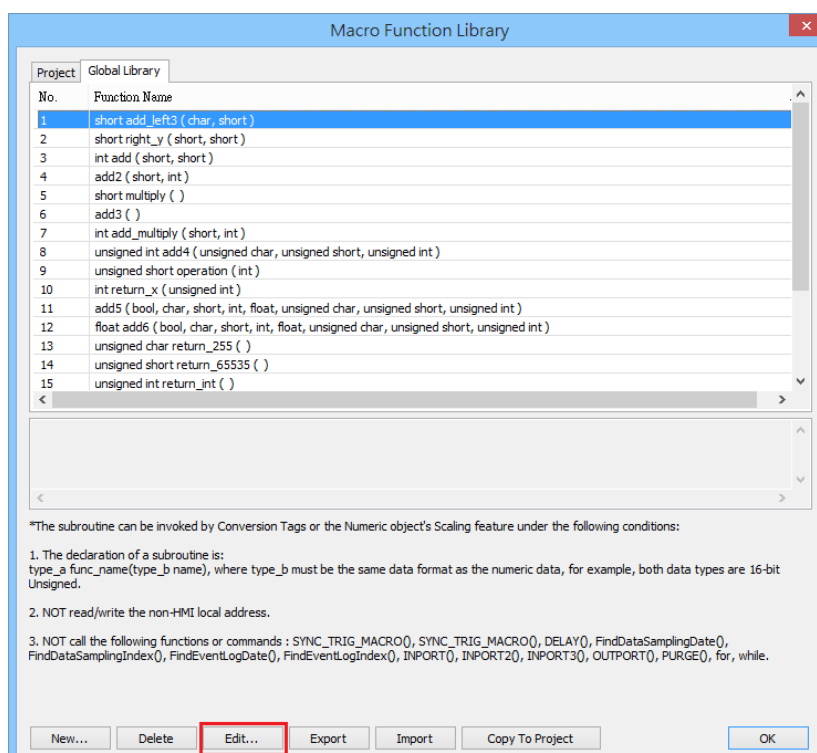

3. Double click the function to be modified can also enter Function Editor.

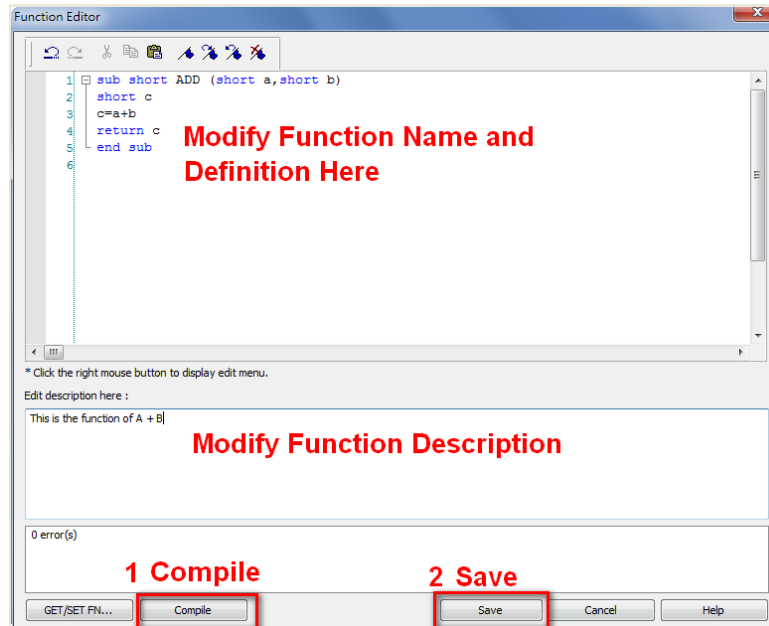

4. After modifying, [Compile] then [Save] before leaving.

18.9.3.4. Import a Function

1. Functions can be imported using an external .mlb file.

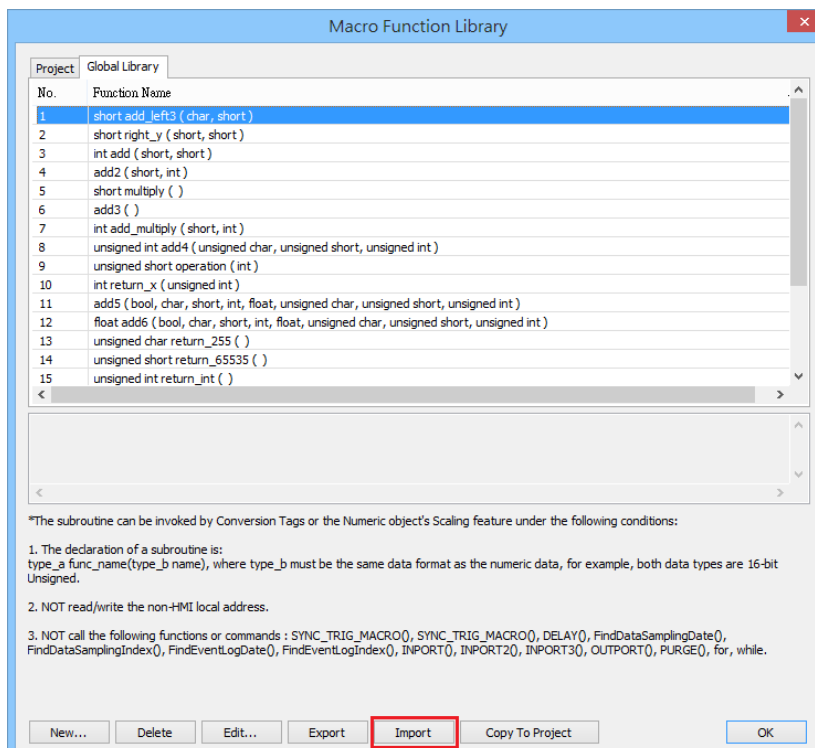

2. For example, import a function library “math.mlb” which contains a function “test1”. Click [Open].

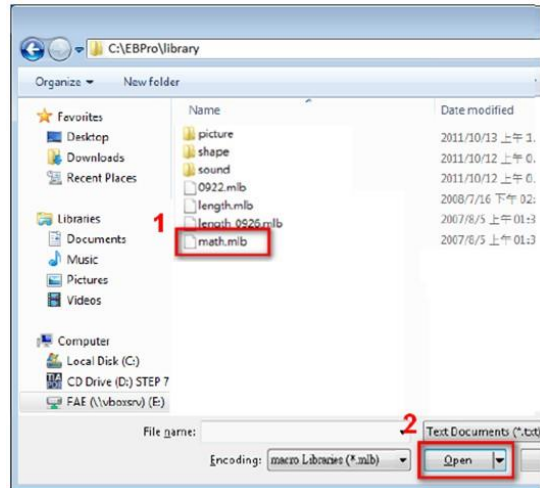

3. When importing a function which already exists in the Library, a confirmation pop-up will be shown. The buttons are:

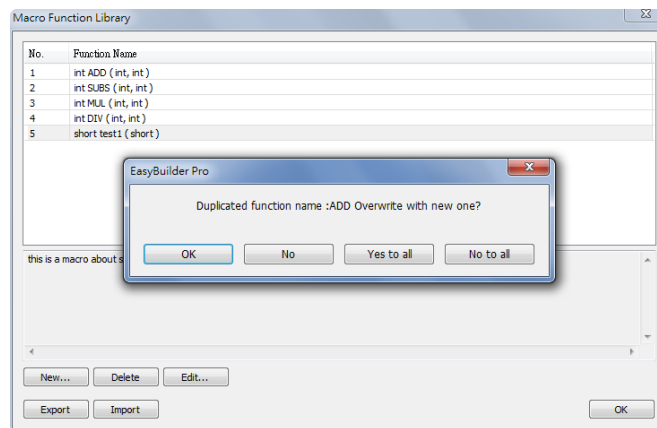

[OK]: Overwrite the existing function with the imported one.

[NO]: Cancel the importing of the function with the same name.

[Yes to all]: Overwrite using all the imported functions with the same name.

[No to all]: Cancel the importing of all the functions with the same name.

4. The imported functions will be saved in Default Function Library, so if “math.mlb” file is deleted, “test1” will still exist in the Library, even restarting EasyBuilder Pro.

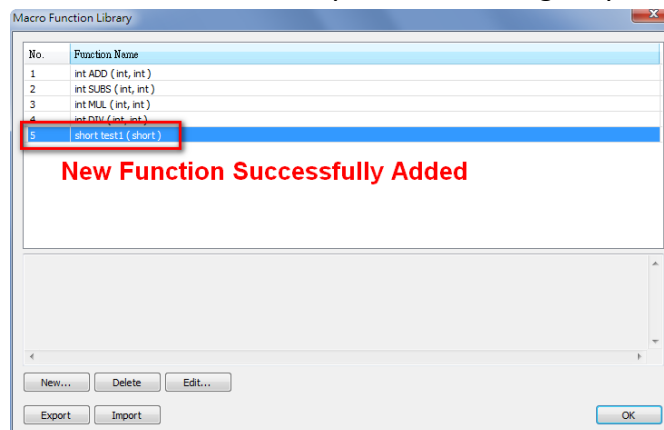

18.9.3.5. Export a Function

1. Export the function from Function Library and save as .mlb file. Click [Export].

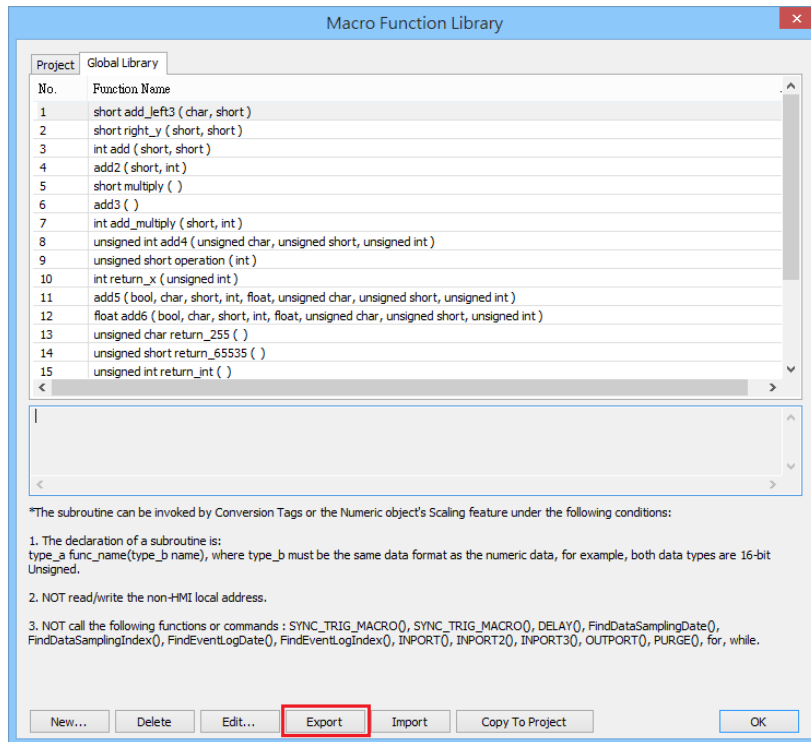

2. Select the function to be exported, and click [Export].

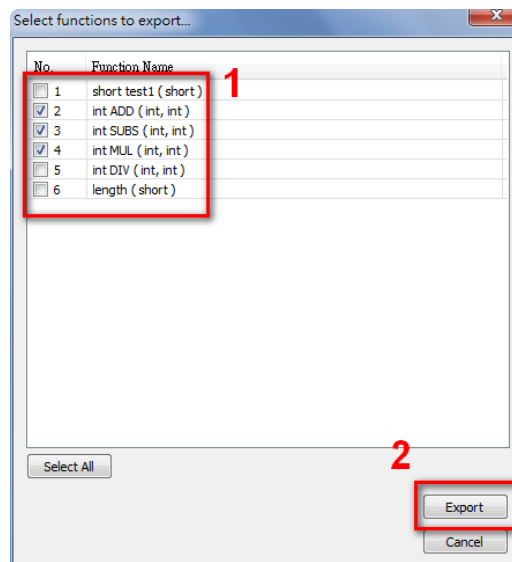

3. A "math.mlb" file can be found under export directory. This file contains 4 functions: ADD, SUBS, MUL, and DIV.
4. The exported .mlb file can be imported on another PC. Open HMI programming software, import, then the functions in this file can be used.

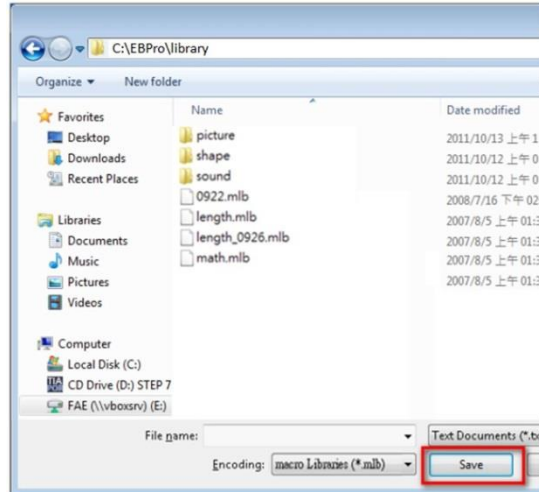

18.10. Some Notes about Using the Macro

1. The maximum storage space of local variables in a macro is 4K bytes. So the maximum array size of different variable types are as follows:

char	a[4096]
bool	b[4096]
short	c[2048]
int	d[1024]
float	e[1024]
2. A maximum of 255 macros are allowed in an EasyBuilder Pro project.
3. A macro may cause the HMI unresponsive. Possible reasons are:
 - A macro contains an infinite loop with no PLC communication.
 - The size of an array exceeds the storage space in a macro.
4. The PLC communication speed affects the running time for the macro to execute. Also, too many macros may slow down the communication between HMI and PLC.

18.11. Use the Free Protocol to Control a Device

If EasyBuilder Pro does not provide a driver for a specific device, users can use OUTPORT and INPORT built-in functions to control the device. The data sent by OUTPORT and INPORT must follow the communication protocol of the device. The following example explains how to use these two functions to control a MODBUS RTU device.

1. First, create a new device in the device table. The device type of the new device is set to “Free Protocol” and named with “MODBUS RTU device” as follows:

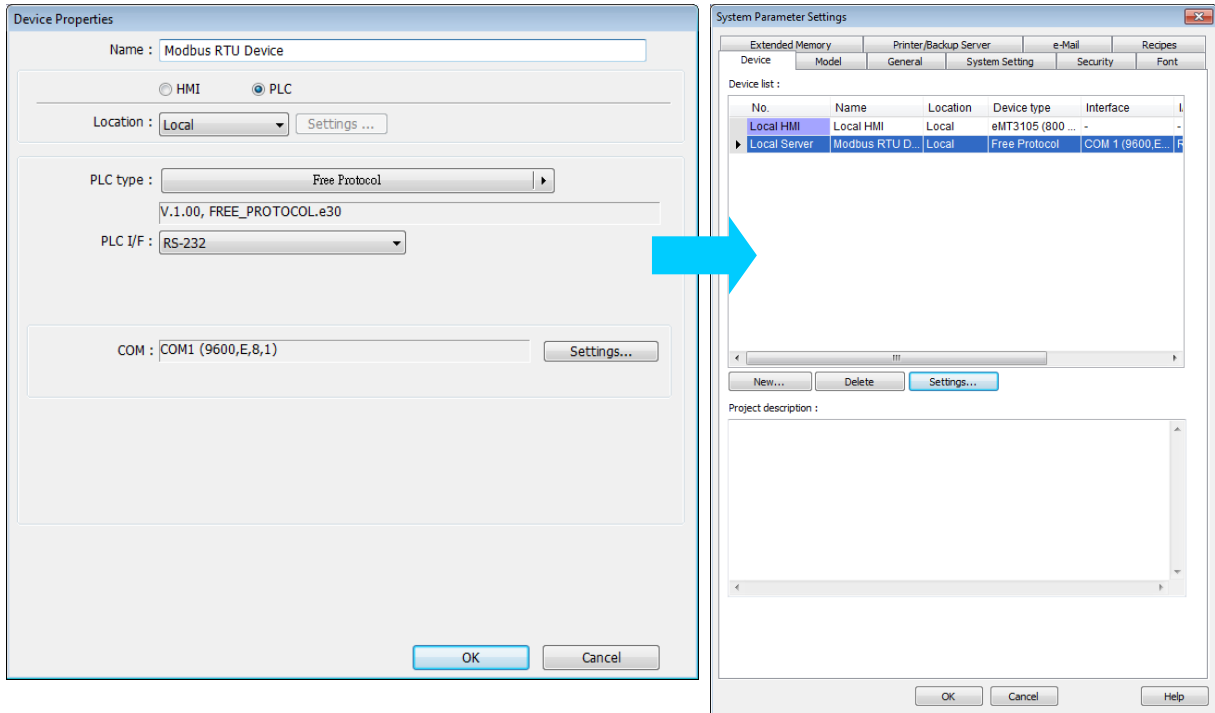

- The interface of the device (PLC I/F) uses [RS-232]. If a MODBUS TCP/IP device is connected, the interface should be [Ethernet] with correct IP and port number as follows:

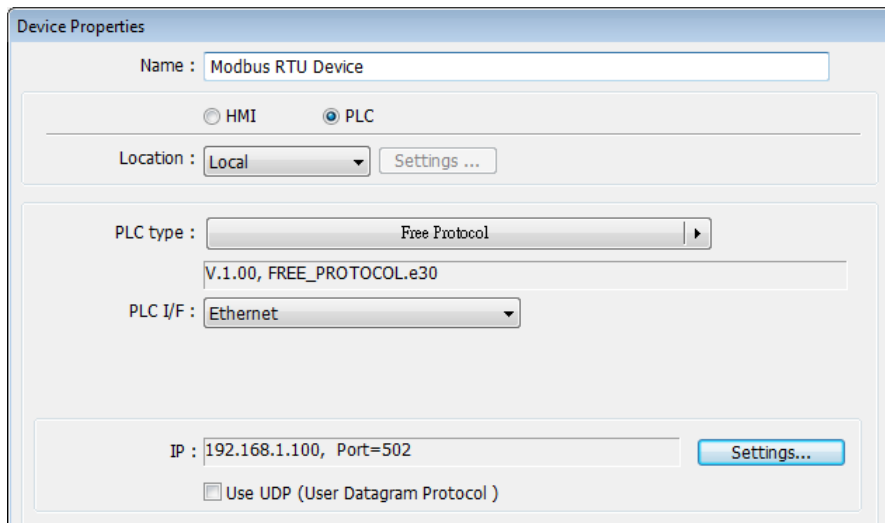

Suppose that the HMI will read the data of 4x_1 and 4x_2 on the device. First, utilize OUTPORT to send out a read request to the device. The format of OUTPORT is:

OUTPORT(command[start], device_name, cmd_count)

Since “MODBUS RTU device” is a MODBUS RTU device, the read request must follow MODBUS RTU protocol. The request uses “Reading Holding Registers (0x03)” command to read data. The following picture displays the content of the command. (The items of the station number (byte 0) and the last two bytes (CRC) are ignored).

Request

Function code	1 Byte	0x03
Starting Address	2 Bytes	0x0000 to 0xFFFF
Quantity of Registers	2 Bytes	1 to 125 (0x7D)

Response

Function code	1 Byte	0x03
Byte count	1 Byte	2 x N*
Register value	N* x 2 Bytes	

*N = Quantity of Registers

Error

Error code	1 Byte	0x83
Exception code	1 Byte	01 or 02 or 03 or 04

Depending on the protocol, the content of a read command as follows (The total is 8 bytes):

command[0]: station number (BYTE 0)
 command[1]: function code (BYTE 1)
 command[2]: high byte of starting address (BYTE 2)
 command[3]: low byte of starting address (BYTE 3)
 command[4]: high byte of quantity of registers (BYTE 4)
 command[5]: low byte of quantity of registers (BYTE 5)
 command[6]: low byte of 16-bit CRC (BYTE 6)
 command[7]: high byte of 16-bit CRC (BYTE 7)

So a read request is designed as follows:

```

char command[32]
short address, checksum

FILL(command[0], 0, 32) // initialize command[0]~command[31] to 0

command[0] = 0x1 // station number
command[1] = 0x3 // read holding registers (function code is 0x3)

address = // starting address (4x_1) is 0
HIBYTE(address, command[2])
LOBYTE(address, command[3])

read_no = 2 // the total words of rading is 2 words
HIBYTE(read_no, command[4])
LOBYTE(read_no, command[5])

CRC(command[0], checksum, 6) // calculate 16-bit CRC

LOBYTE(checksum, command[6])
HIBYTE(checksum, command[7])
  
```

Lastly, use OUPORT to send out this read request to PLC.

```

OUTPORT(command[0], "MODBUS RTU Device", 8) // send read request
  
```

After sending out the request, use INPORT to get the response from PLC. Depending on the protocol, the content of the response is as follows (the total byte is 9):

command[0]: station number	(BYTE 0)
command[1]: function code	(BYTE 1)
command[2]: byte count	(BYTE 2)
command[3]: high byte of 4x_1	(BYTE 3)
command[4]: low byte of 4x_1	(BYTE 4)
command[5]: high byte of 4x_2	(BYTE 5)
command[6]: high byte of 4x_2	(BYTE 6)
command[7]: low byte of 16-bit CRC	(BYTE 7)
command[8]: high byte of 16-bit CRC	(BYTE 8)

The format of INPORT is:

```
INPORT(response[0], "MODBUS RTU Device", 9, return_value) // read reponse
```

Where the real read count is restored to the variable return_value (unit is byte). If return_value is 0, it means reading fails in executing INPORT.

According to the MODBUS RTU protocol specification, the correct response[1] must be equal to 0x03. After getting correct response, calculate the data of 4x_1 and 4x_2 and put in the data into LW-100 and LW-101 of HMI.

```
If (return_value) >0 and response[1] == 0x3) then
  read_data[0] = response[4] + (response[3] << 8) // 4x_1
  read_data[1] = response[6] + (response[5] << 8) // 4x_2

  SetData(read_data[0], "Local HMI", LW, 100, 2)
endif
```

The complete macro is as follows:

```

// Read Holding Registers
macro_command main()

char command[32], response[32]
short address, checksum
short read_no, return_value, read_data[2], i

FILL(command[0], 0, 32)// initialize command[0]~command[31] to 0
FILL(response[0], 0, 32)

command[0] = 0x1// station number
command[1] = 0x3// read holding registers (function code is 0x3)

address = 0
address = 0// starting address (4x_1) is 0
HIBYTE(address, command[2])
LOBYTE(address, command[3])

read_no = 2/ the total words of reading is 2 words
HIBYTE(read_no, command[4])
LOBYTE(read_no, command[5])

CRC(command[0], checksum, 6)// calculate 16-bit CRC

LOBYTE(checksum, command[6])
HIBYTE(checksum, command[7])

OUTPORT(command[0], "MODBUS RTU Device", 8)// send request
INPORT(response[0], "MODBUS RTU Device", 9, return_value)// read response

if (return_value > 0 and response[1] == 0x3) then
    read_data[0] = response[4] + (response[3] << 8)// 4x_1
    read_data[1] = response[6] + (response[5] << 8)// 4x_2

    SetData(read_data[0], "Local HMI", LW, 100, 2)
end if

end macro_command

```

The following example explains how to design a request to set the status of 0x_1. The request uses "Write Single Coil(0x5)" command.

Request

Function code	1 Byte	0x05
Output Address	2 Bytes	0x0000 to 0xFFFF
Output Value	2 Bytes	0x0000 or 0xFF00

Response

Function code	1 Byte	0x05
Output Address	2 Bytes	0x0000 to 0xFFFF
Output Value	2 Bytes	0x0000 or 0xFF00

Error

Error code	1 Byte	0x85
Exception code	1 Byte	01 or 02 or 03 or 04

The complete macro is as follows:

```
// Write Single Coil (ON)
macro_command main()

char command[32], response[32]
short address, checksum
short i, return_value

FILL(command[0], 0, 32)// initialize command[0]~ command[31] to 0
FILL(response[0], 0, 32)

command[0] = 0x1// station number
command[1] = 0x5// function code : write single coil

address = 0
HIBYTE(address, command[2])
LOBYTE(address, command[3])

command[4] = 0xff// force 0x_1 on
command[5] = 0

CRC(command[0], checksum, 6)

LOBYTE(checksum, command[6])
HIBYTE(checksum, command[7])

OUTPORT(command[0], "MODBUS RTU Device", 8)// send request
INPORT(response[0], "MODBUS RTU Device", 8, return_value)// read response

end macro_command
```

18.12. Compiler Error Message

- Error Message Format

error C# : error description

(# is the error message number)

Example: error C37 : undeclared identifier : i

When there are compile errors, the description of the error can be found by the compiler error message number.

- Error Description

(C1) syntax error : 'identifier'

There are many possibilities to cause compiler error.

For example:

```
macro_command main()  
char i, 123xyz // this is an unsupported variable name  
end macro_command
```

(C2) 'identifier' used without having been initialized

Macro must define the size of an array during declaration.

For example:

```
macro_command main()  
char i  
int g[i] // i must be a numeric constant  
end macro_command
```

(C3) redefinition error : 'identifier'

The name of variable and function within its scope must be unique.

For example:

```
macro_command main()  
int g[10], g // error  
end macro_command
```

(C4) function name error : 'identifier'

Reserved keywords and constant cannot be the name of a function

For example :

```
sub int if() // error
```

(C5) parentheses have not come in pairs

Statement missing "(" or ")"

For example :

```
macro_command main ) // missing "("
```

(C6) illegal expression without matching 'if'

Missing expression in "if" statement

(C7) illegal expression (no 'then') without matching 'if'

Missing "then" in "if" statement

(C8) illegal expression (no 'end if')

Missing "end if"

(C9) illegal 'end if' without matching 'if'

Unfinished "If" statement before "End If"

(C10) illegal 'else'

The format of "if" statement is :

```
if [logic expression] then
```

```
[ else [if [logic expression] then ] ]
```

```
end if
```

Any format other than this format will cause a compile error.

(C17) illegal expression (no 'for') without matching 'next'

"for" statement error : missing "for" before "next"

(C18) illegal variable type (not integer or char)

Should be integer or char variable

(C19) variable type error

Missing assign statement

(C20) must be keyword 'to' or 'down'

Missing keyword "to" or "down"

(C21) illegal expression (no 'next')

The format of "for" statement is:

```
for [variable] = [initial value] to [end value] [step]
```

```
next [variable]
```

Any format other than this format will cause a compile error.

(C22) 'wend' statement contains no 'while'

"While" statement error : missing "while" before "Wend"

(C23) illegal expression without matching 'wend'

The format of "While" statement is :

```
while [logic expression]
```

```
wend
```

Any format other than this format will cause a compile error.

(C24) syntax error : 'break'

"break" statement can only be used in "for", "while" statement.

(C25) syntax error : 'continue'

"continue" statement can only be used in "for" statement, or "while" statement.

(C26) syntax error

Error in expression.

(C27) syntax error

The mismatch of an operation object in expression can cause a compile error.

For example :

```
macro_command main( )
```

```
int a, b
```

```
for a = 0 to 2
```

```
b = 4 + xyz // illegal : xyz is undefined
```

```
next a
```

```
end macro_command
```

(C28) must be 'macro_command'
There must be 'macro_command'

(C29) must be key word 'sub'
The format of function declaration is:

```
sub [data type] function_name(...)  
.....  
end sub
```

For example::

```
sub int pow(int exp)  
.....  
end sub
```

format other than this format will cause a compile error.

(C30) number of parameters is incorrect
Mismatch of the number of parameters

(C31) parameter type is incorrect
Mismatch of data type of parameter. When a function is called, the data type and the number of parameters should match the declaration of function, otherwise it will cause a compile error.

(C32) variable is incorrect
The parameters of a function must be equivalent to the arguments passing to a function to avoid compile error.

(C33) function name : undeclared function

(C34) expected constant expression
Illegal array index format.

(C35) invalid array declaration

(C36) array index error

(C37) undeclared identifier : i 'identifier'

Any variable or function should be declared before use.

(C38) un-supported PLC data address

The parameter of GetData(...), SetData(...) should be legal PLC address. If the address is illegal, this error message will be shown.

(C39) 'identifier' must be integer, char or constant

The format of array is:

Declaration: array_name[constant] (constant is the size of the array)

Usage: array_name[integer, character or constant]

Any format other than this format will cause a compile error.

(C40) execution syntax should not exist before variable declaration or constant definition

For example :

```
macro_command main( )
int a, b
for a = 0 To 2
    b = 4 + a
int h, k // illegal – definitions must occur before any statements or expressions
        // for example, b = 4 + a
next a
end macro_command
```

(C41) float variables cannot be contained in shift calculation

(C42) function must return a value

(C43) function should not return a value

(C44) float variables cannot be contained in calculation

(C45) PLC address error

(C46) array size overflow (max. 4k)

(C47) macro command entry function is not only one

(C48) macro command entry function must be only one

The only one main entrance of macro is :

```
macro_command function_name( )
end macro_command
```

(C49) an extended addressee's station number must be between 0 and 255

For example :

```
SetData(bits[0] , "PLC 1", LB , 300#123, 100)
// illegal : 300#123 means the station number is 300, but the maximum is 255
```

(C50) an invalid PLC name

PLC name is not defined in the device list of system parameters.

(C51) macro command do not control a remote device

A macro can only control a local machine.

For example :

```
SetData(bits[0] , "PLC 1", LB , 300#123, 100)
"PLC 1" is connected with the remote HMI ,so it cannot work.
```

18.13. Sample Macro Code

- "for" statement and other expressions (arithmetic, bitwise shift, logic and comparison)

```
macro_command main()
int a[10], b[10], i
```

```
b[0] = (400 + 400 << 2) / 401
```

```
b[1] = 22 * 2 - 30 % 7
```

```
b[2] = 111 >> 2
```

```
b[3] = 403 > 9 + 3 >= 9 + 3 < 4 + 3 <= 8 + 8 == 8
```

```
b[4] = not 8 + 1 and 2 + 1 or 0 + 1 xor 2
```

```
b[5] = 405 and 3 and not 0
```

```
b[6] = 8 & 4 + 4 & 4 + 8 | 4 + 8 ^ 4
```

```
b[7] = 6 - (~4)
```

```
b[8] = 0x11
```

```
b[9] = 409
```

```
for i = 0 to 4 step 1
  if (a[0] == 400) then
    GetData(a[0], "Device 1", 4x, 0,9)
    GetData(b[0], "Device 1", 4x, 11,10)
  end If
next i
end macro_command
```

- “while”, “if” and “break” statements

```
macro_command main()
int b[10], i
i = 5
while i == 5 - 20 % 3
  GetData(b[1], "Device 1", 4x, 11, 1)

  if b[1] == 100 then
    break
  end if
wend
end macro_command
```

- Global variables and function call

```
char g
sub int fun(int j, int k)
  int y

  SetData(j, "Local HMI", LB, 14, 1)
  GetData(y, "Local HMI", LB, 15, 1)
  g = y

  return y
end Sub

macro_command main()
  int a, b, i

  a = 2
  b = 3
```

```
i = fun(a, b)
  SetData(i, "Local HMI", LB, 16, 1)
end macro_command
```

- “if” statement

```
macro_command main()
  int k[10], j

  for j = 0 to 10
    k[j] = j
  next j

  if k[0] == 0 then
    SetData(k[1], "Device 1", 4x, 0, 1)
  end if
```

```
if k[0] == 0 then
  SetData(k[1], "Device 1", 4x, 0, 1)
else
  SetData(k[2], "Device 1", 4x, 0, 1)
end if
```

```
if k[0] == 0 then
  SetData(k[1], "Device 1", 4x, 1, 1)
else if k[2] == 1 then
  SetData(k[3], "Device 1", 4x, 2, 1)
end If
```

```
if k[0] == 0 then
  SetData(k[1], "Device 1", 4x, 3, 1)
else if k[2] == 2 then
  SetData(k[3], "Device 1", 4x, 4, 1)
else
  SetData(k[4], "Device 1", 4x, 5, 1)
end If
end macro_command
```

- “while” and “wend” statements

```
macro_command main()
char i = 0
int a[13], b[14], c = 4848

b[0] = 13

while b[0]
    a[i] = 20 + i * 10

    if a[i] == 120 then
        c = 200
        break
    end if

    i = i + 1
wend

SetData(c, "Device 1", 4x, 2, 1)
end macro_command
```

- “break” and “continue” statements

```
macro_command main()
char i = 0
int a[13], b[14], c = 4848

b[0] = 13

while b[0]
    a[i] = 20 + i * 10

    if a[i] == 120 then
        c = 200
        i = i + 1
        continue
    end if

    i = i + 1
```

```
    if c == 200 then
        SetData(c, "Device 1", 4x, 2, 1)
    break
    end if
wend
end macro_command
```

- Array

```
macro_command main()
int a[25], b[25], i
```

```
b[0] = 13
```

```
for i = 0 to b[0] step 1
    a[i] = 20 + i * 10
next i
```

```
SetData(a[0], "Device 1", 4x, 0, 13)
end macro_command
```

18.14. Macro TRACE Function

TRACE function can be used with EasyDiagnoser to show the current content of the variables. The following example illustrates how TRACE function could be used in macro.

1. First of all, add a new macro "macro_0" in the project, and in "macro_0" add TRACE ("LW = %d", a). "%d" indicates display current value of LW in decimal format. The content of "macro_0" is as follows:

```

1
2 macro_command main()
3
4 short a
5 GetData(a, "Local HMI", LW, 0, 1)
6 a=a+1
7 SetData(a, "Local HMI", LW, 0, 1)
8 TRACE ("LW0 = %d" , a)
9
10 end macro_command

```

2. Secondly, add a Numeric Display object and a Function Key object in window no. 10 of the project. The Function Key object is used to execute macro_0.

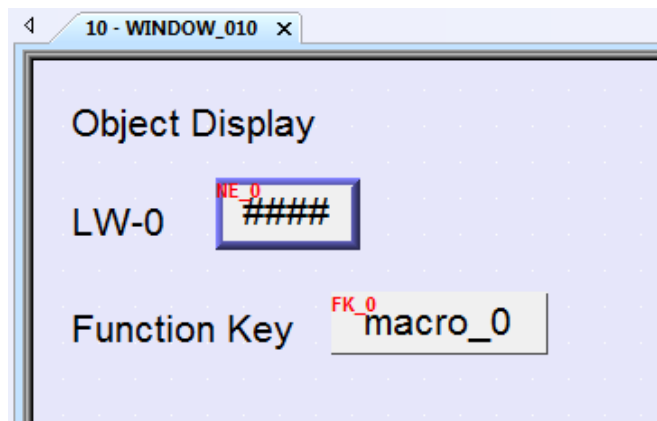

3. Lastly, compile the project and execute [Off-line simulation] or [On-line simulation].
4. When processing simulation on PC, right click and select "Run EasyDiagnoser" in the pop-up menu.

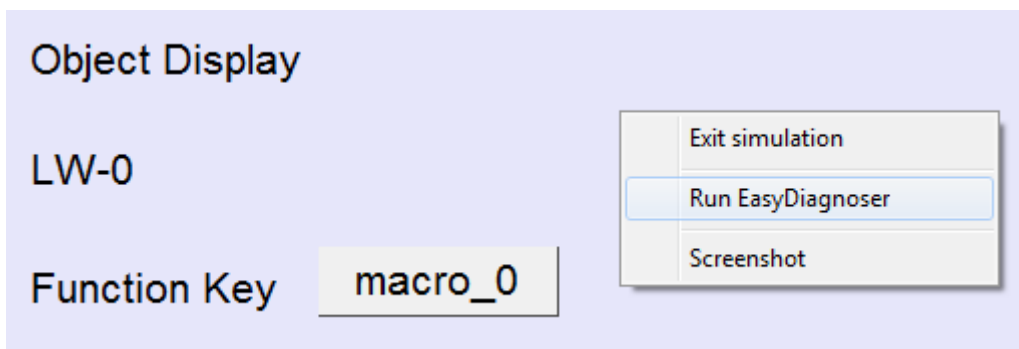

5. Afterwards, EasyDiagnoser will be started. [Logger] window displays whether EasyDiagnoser is able to connect with the HMI to be watched or not. [Output] window displays the output of the TRACE function. The illustration below shows that EasyDiagnoser succeeds in connecting with HMI.

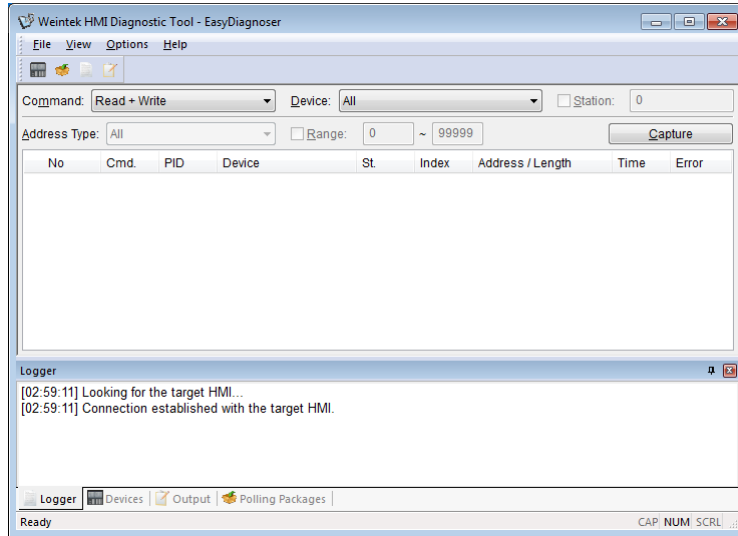

When EasyDiagnoser is not able to connect with HMI, [Logger] window displays content as shown in the following figure:

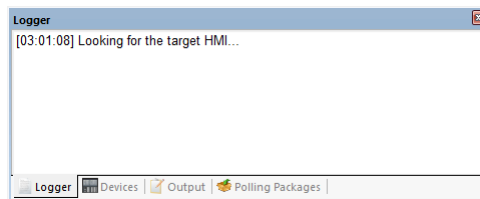

6. The possible reason of not being able to get connection with HMI can be failure in executing simulation on PC. Another reason is that the Port No. used in project for simulation on PC is incorrect (or occupied by system). Please change Port No. as shown, compile project then do simulation again.

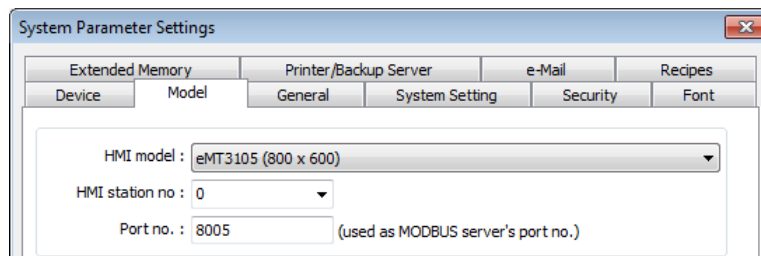

7. In EasyDiagnoser, the Port No. should be set the same as the Port No. in the project.

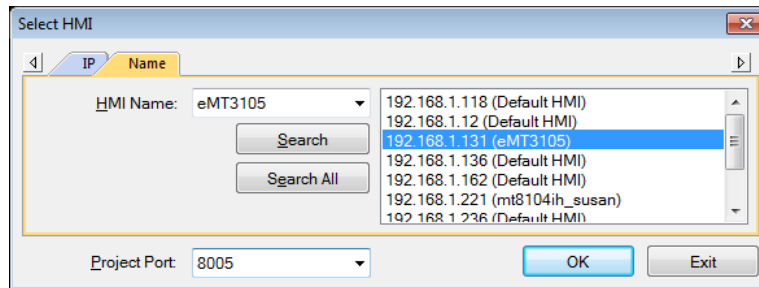

The three consecutive ports of the project port no. are preserved for HMI communication. In the setting above as an example, Port No. is set as 8005. Port 8005, 8006 and 8007 should be reserved. In this case when executing simulation on PC, please make sure that these ports are not occupied by other programs.

TRACE Syntax List

Name	TRACE
Syntax	TRACE(format, argument)
Description	<p>Use this function to send specified string to the EasyDiagnoser. Users can print out the current value of variables during run-time of macro for debugging. When TRACE encounters the first format specification (if any), it converts the value of the first argument after format and outputs it accordingly. format refers to the format control of output string. A format specification, which consists of optional (in []) and required fields (in bold), has the following form:</p> <p>%[flags] [width] [.precision] type</p> <p>Each field of the format specification is described as below:</p> <p>flags (optional):</p> <ul style="list-style-type: none"> - + <p>width (optional):</p> <p>A nonnegative decimal integer controlling the minimum number of characters printed.</p> <p>precision (optional):</p> <p>A nonnegative decimal integer which specifies the precision and the number of characters to be printed.</p> <p>type:</p> <ul style="list-style-type: none"> C or c : specifies a single-byte character. d : signed decimal integer. i : signed decimal integer. o : unsigned octal integer. u : unsigned decimal integer. X or x : unsigned hexadecimal integer. E or e : Signed value having the form. [-]d.dddd e [sign]ddd where d is a single decimal digit, dddd is one or more decimal digits, ddd i exactly three decimal digits, and sign is + or - . f : Signed value having the form [-]dddd.dddd, where dddd is one or more decimal digits. <p>The length of output string is limited to 256 characters.</p>

	The argument part is optional.
Example	<pre>macro_command main() char c1 = ' a' short s1 = 32767 float f1 = 1.234567 TRACE("The results are") // output: The results are TRACE("c1 = %c, s1 = %d, f1 = %f" , c1, s1, f1) // output: c1 = a, s1 = 32767, f1 = 1.234567 end macro_command</pre>

8. Use LB-9059 to disable MACRO TRACE function (when ON). When set ON, the output message of TRACE won't be sent to EasyDiagnoser.
9. Users can directly execute EasyDiagnoser.exe from Utility Manager. In Utility Manager, current HMI on line will be listed; users can simply select the HMI to be watched. Please note that Project Port should be the same as Port No. used in project file.

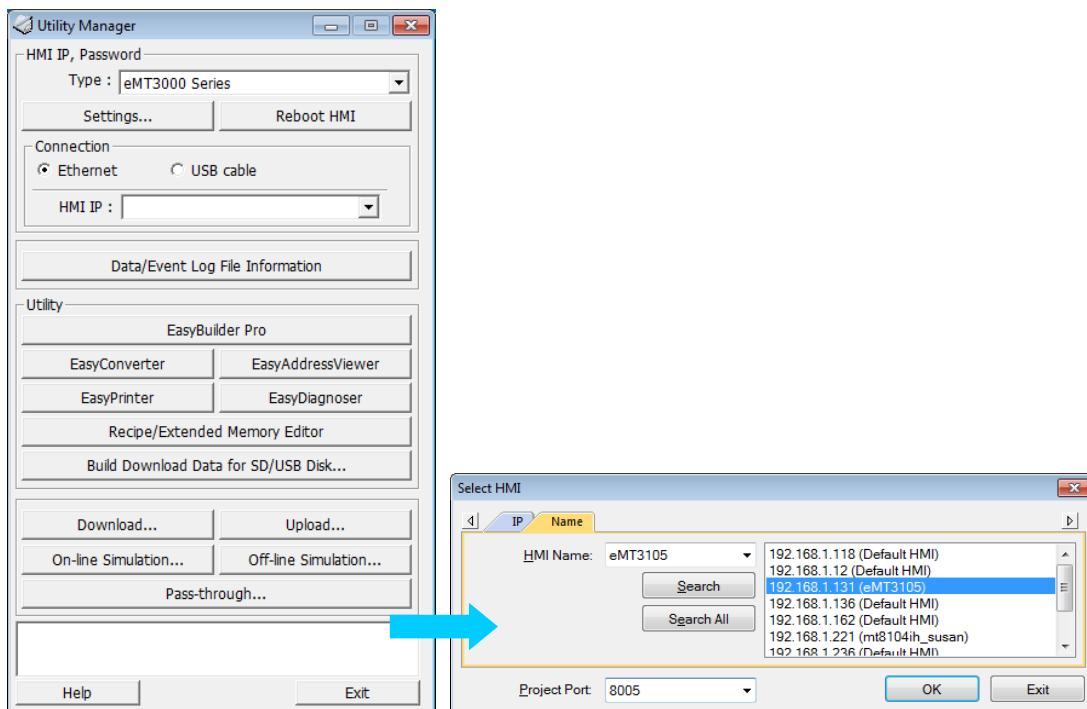

10. Download the project to HMI and start the project. If EasyDiagnoser is unable to get connection with the HMI to be watched, it is possible that HMI power is not ON, or Port No. is incorrect. This may cause EasyDiagnoser to connect then disconnect with HMI continuously. Please check the Port No. in EasyDiagnoser settings.
11. When EasyDiagnoser succeeds in connecting with HMI, simply execute macro_0, [Output] window will then display the output of the TRACE function.

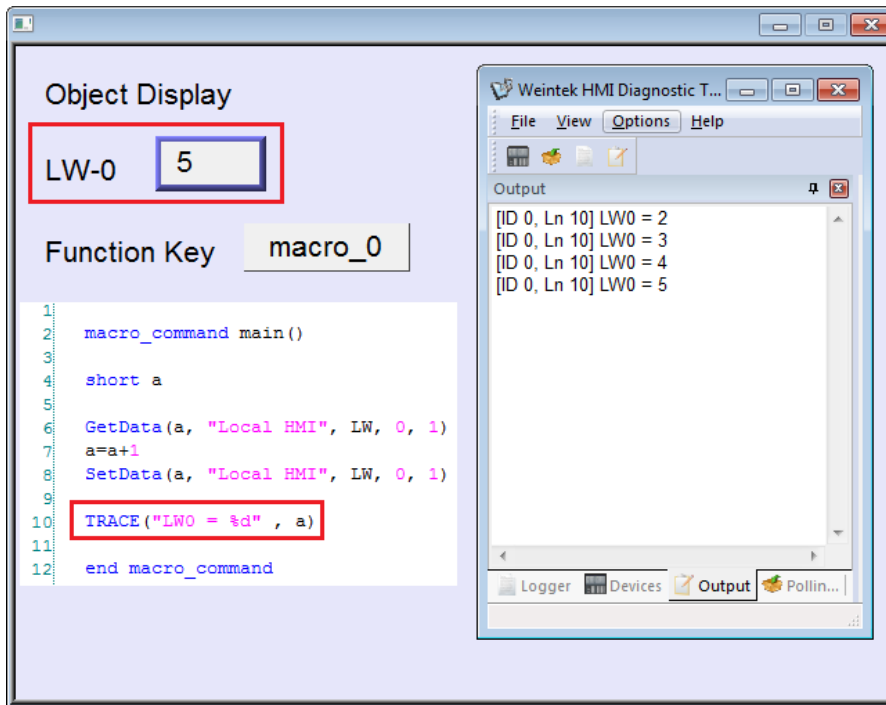

18.15. Example of String Operation Functions

String operation functions are added to macro to provide a convenient way to operate strings. The term “string” means a sequence of ASCII characters, and each of them occupies 1 byte. The sequence of characters can be stored into 16-bit registers with least significant byte first. For example, create an ASCII Input object and setup as follows:

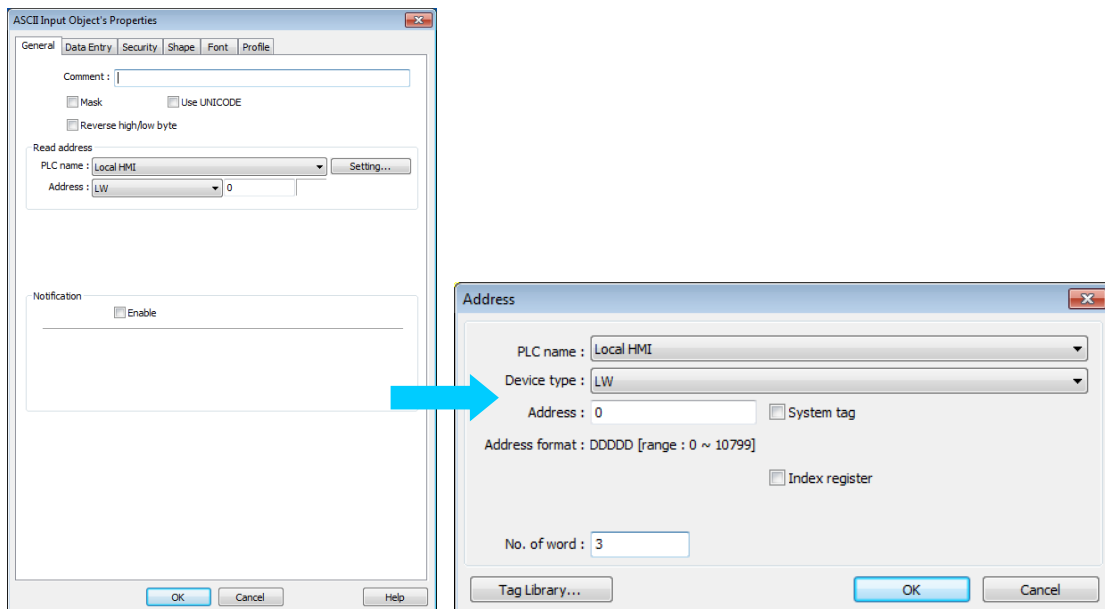

Run simulation and input “abcdef”:



The string “abcdef” is stored in LW-0~LW-2 as follows (LB represents low byte and HB represents high byte):

	HB	LB
LW0	'B'	'A'
LW1	'D'	'C'
LW2	'F'	'E'
LW3		
LW4		
LW5		

The ASCII Input object reads 1 word (2 bytes) at a time as described in the previous chapter. Suppose an ASCII Input object is set to read 3 words as shown in the above example, it can actually read at most 6 ASCII characters since that one ASCII character occupies 1 byte. The functionality of each string operation function is described in the following table:

Function name	Description
StringGet	Read string data from a device.
StringGetEx	Read string data from a device and continue executing next command even if no response from that device.
StringSet	Write string data to a device.
StringSetEx	Write string data to a device and continue executing next command even if no response from that device.
StringCopy	Copy one string to another.
StringMid	Retrieve a substring.
StringDecAsc2Bin	Convert a decimal string to an integer.
StringBin2DecAsc	Convert an integer to a decimal string.
StringDecAsc2Float	Convert a decimal string to floats.
StringFloat2DecAsc	Convert a float to a decimal string.
StringHexAsc2Bin	Convert a hexadecimal string to binary data.
StringBin2HexAsc	Convert binary data into a hexadecimal string.
StringLength	Obtain the length of a string.
StringCat	Append source string to destination string.
StringCompare	Do a case-sensitive comparison of two strings.
StringCompareNoCase	Do a case-insensitive comparison of two strings.
StringFind	Find a substring inside a larger string.
StringReverseFind	Find a substring inside a larger string; starts from the end.
StringFindOneOf	Find the first matching character from a set.
StringIncluding	Extracts a substring that contains only the characters in a set.

StringExcluding	Extracts a substring that contains only the characters not in a set.
StringToUpper	Convert the characters of a string to uppercase.
StringToLower	Convert the characters of a string to lowercase.
StringToReverse	Reverse the characters of a string.
StringTrimLeft	Trim the leading specified characters in a set from the source string.
StringTrimRight	Trim the trailing specified characters in a set from the source string.
StringInsert	Insert a string in a specific location within another string.

For more detailed information of the above string operation functions, please check out the “Built-In Function Block” section. In order to demonstrate the powerful usage of string operation functions, the following examples will show you step by step how to create executable project files using the new functions; starts from creating a macro, ends in executing simulation.

1. To read (or write) a string from a device:

Create a new macro:

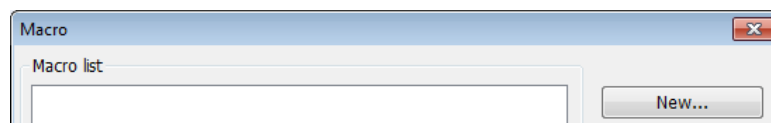

Edit the content:

```

1
2  macro_command main()
3
4  char str[20]
5
6  StringGet(str[0], "Local HMI", LW, 0, 20)
7  StringSet(str[0], "Local HMI", LW, 50, 20)
8
9  end macro_command

```

The first function “StringGet” is used to read a string from LW-0~LW-19, and store it into the str array. The second function “StringSet” is used to output the content of str array.

Add one  ASCII Input object and one  Function Key object in window 10 of the project.

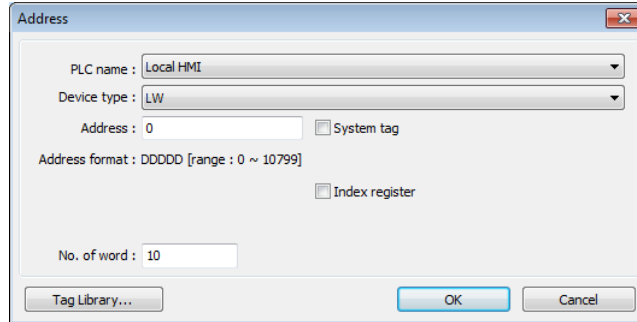

The settings of these objects are shown as below. Function Key object is used to execute macro_0.

 ASCII Input object:

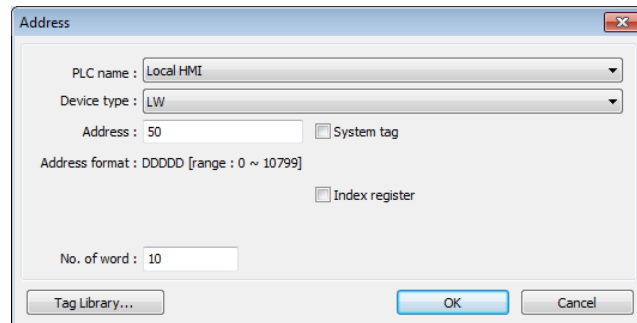
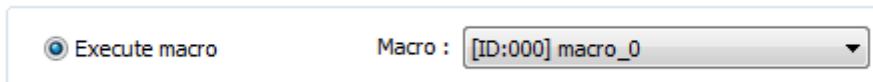

 Function Key object:



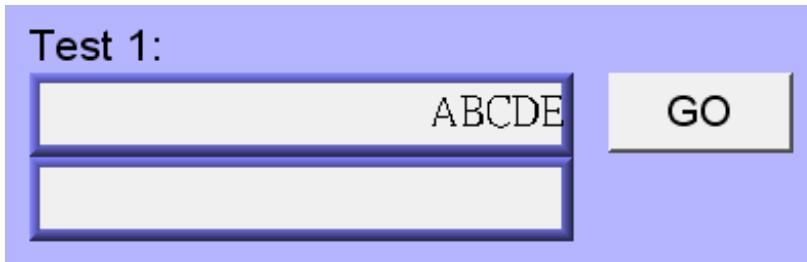

Lastly, use  [Compile] to compile the project and execute  [Off-line simulation] or  [On-line simulation]. Follow the steps below to operate the executing project:

- Step 1. Input string.
- Step 2. Press "GO" button.

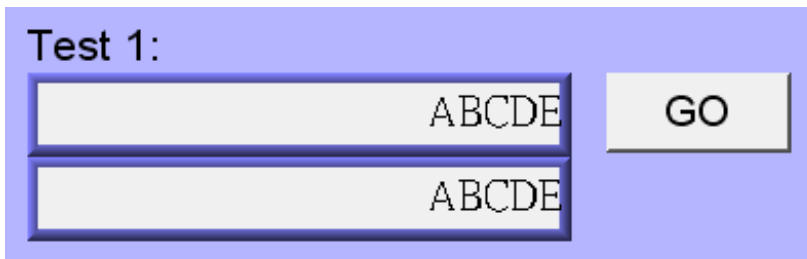

- Step 3. Output string.



2. Initialization of a string.
Create a new macro and edit the content:

```
1
2 macro_command main()
3
4 char str1[20]="abcde"
5 char str2[20]={'a','b','c','d','e'}
6
7 StringSet(str1[0], "Local HMI", LW, 0, 20)
8 StringSet(str2[0], "Local HMI", LW, 50, 20)
9
10 end macro_command
```

The data enclosed in double quotation mark ("") is viewed as a string. str1 is initialized as a string while str2 is initialized as a char array. The following snapshot of simulation shows the difference between str1 and str2 using two ASCII Input objects.

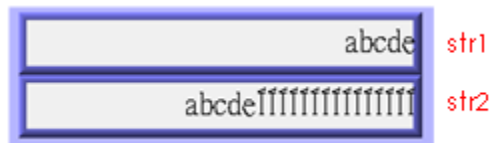

Macro compiler will add a terminating null character ('\0') at the end of a string. The function "StringSet" will send each character of str1 to registers until a null character is reached. The extra characters following the null character will be ignored even if the data count is set to a larger value than the length of string.

On the contrary, macro compiler will not add a terminating null character ('\0') at the end of a char array. The actual number of characters of str2 being sent to registers depends on the value of data count that is passed to the "StringSet" function.



3. A simple login page.

Create a new macro and edit the content, for example, Macro [ID:001] macro_1.



```

1
2 macro_command main()
3
4 char name[20]="admin"
5 char password[20]="123456"
6 char name_input[20], password_input[20]
7 char message_success[40]="Success! Access Accepted."
8 char message_fail[40]="Fail! Access Denied."
9 char message_clear[40]
10 bool name_match=false, password_match=false
11
12 StringGet(name_input[0], "Local HMI", LW, 0, 20)
13 StringGet(password_input[0], "Local HMI", LW, 50, 20)
14
15 name_match = StringCompare(name_input[0], name[0])
16 password_match = StringCompare(password_input[0], password[0])
17
18 FILL(message_clear[0], 0x20, 40) //FILL with white space
19 StringSet(message_clear[0], "Local HMI", LW, 100, 40)
20
21 if (name_match==true and password_match==true) then
22     StringSet(message_success[0], "Local HMI", LW, 100, 40)
23 else
24     StringSet(message_fail[0], "Local HMI", LW, 100, 40)
25 end if
26
27 end macro_command

```

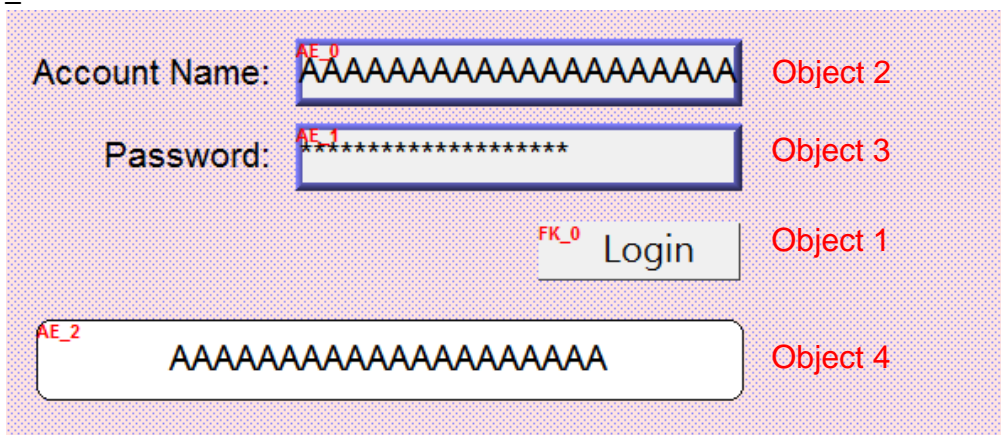
The first two “StringGet” functions will read the strings input by users and store them into arrays named name_input and password_input separately. Use the function “StringCompare” to check if the input account name and password are matched. If the account name is matched, name_match is set true; if the password is matched, password_match is set true. If both name_match and password_match are true, output the string “Success! Access Accepted.”. Otherwise, output the string “Fail! Access Denied.”. Add ASCII Input  and Function Key  objects in window 10 of the project. The settings of these objects are shown as below. Function Key object is used to execute macro_1.



Object 1: Function Key 

Select [Execute macro] and Macro: [ID:000] macro_1.

Object 2: ASCII Input 

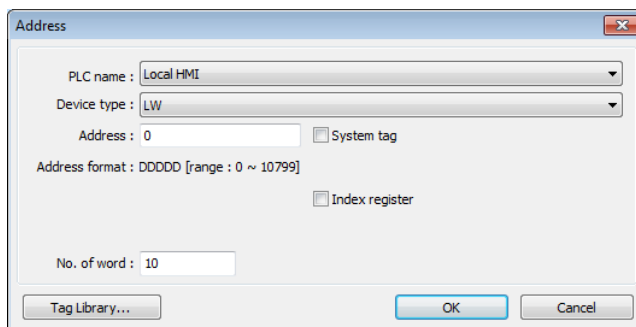

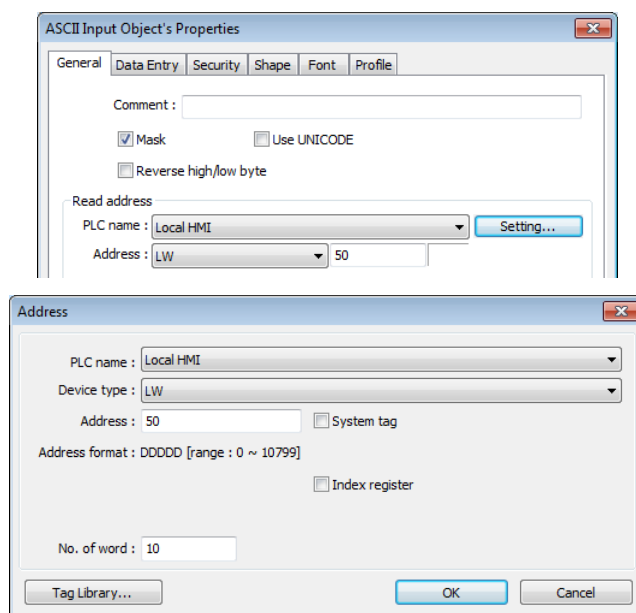

Object 3: ASCII Input 

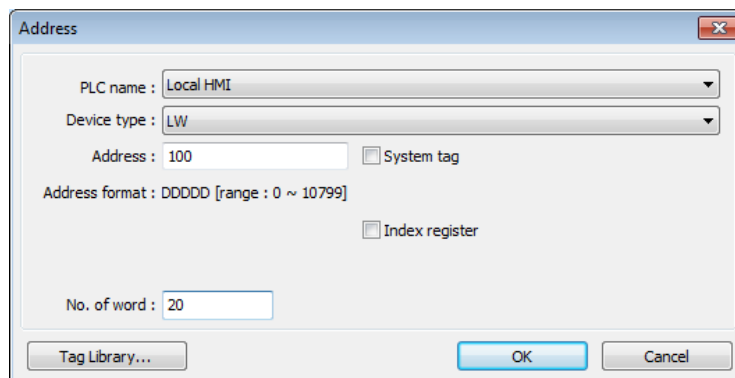

Object 4: ASCII Display 



Lastly, use  [Compile] to compile the project and execute  [Off-line simulation] or  [On-line simulation]. Follow the steps below to operate the executing project:

Step 1. Enter account name.

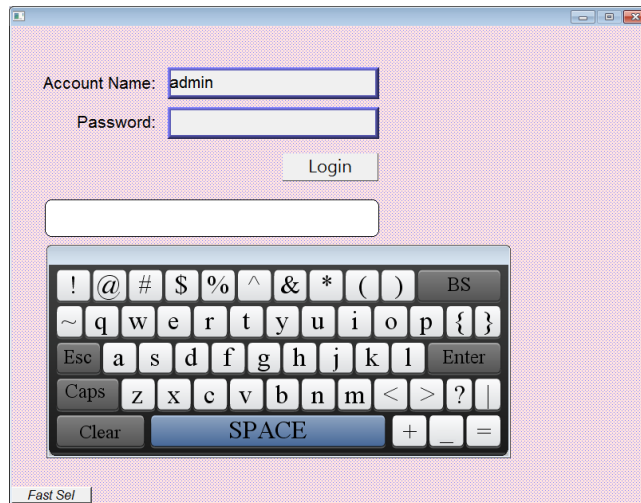

Step 2. Enter password and press [Login] button.

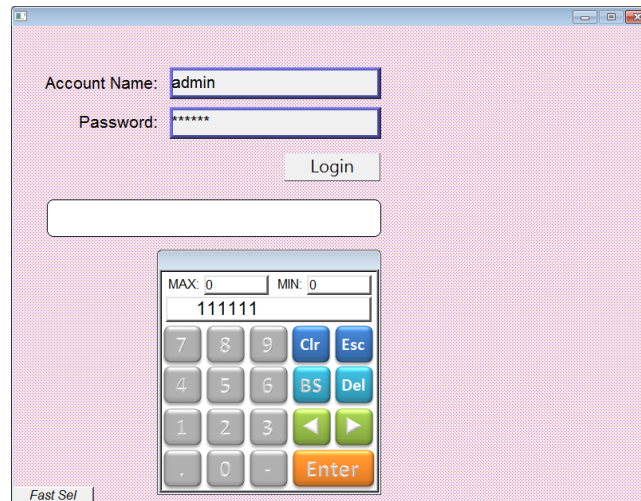

Step 3. Login succeeded or failed.

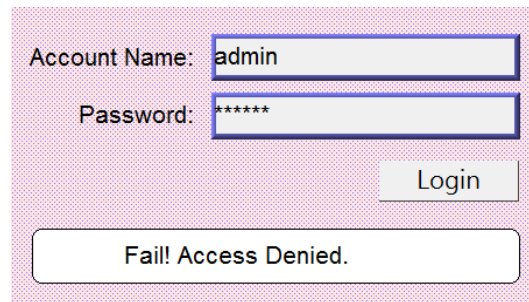
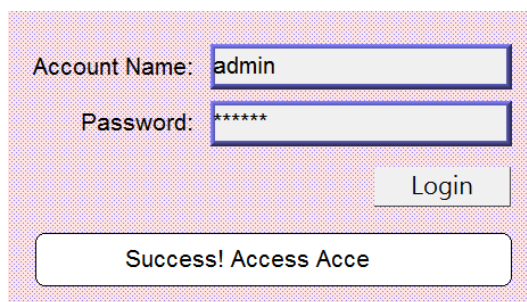

18.16. Macro Password Protection

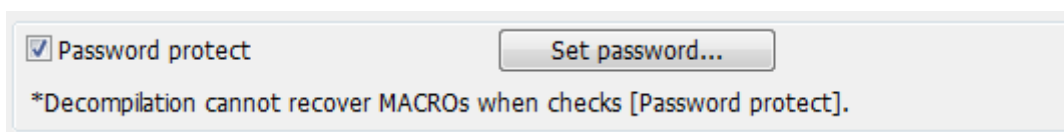

On MACRO editing window there's the [Password protect] selection, tick it and click [Set password...] to set a password less than or equals to 10 characters (support ASCII character only, ex. "a\$#*hFds").

After setting MACRO password, users will have to input correct password when opening MACRO editing window. EasyBuilder Pro should be rebooted for typing the password again after 3 incorrect attempts.

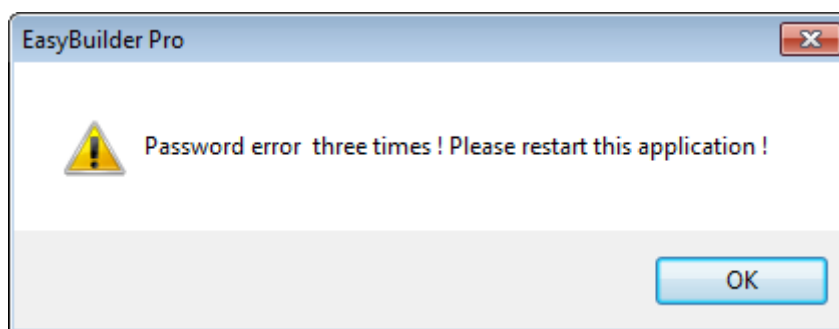

Note

- When MACRO is password protected, de-compilation of EXOB file will not be able to restore MACRO contents.

19. Configure HMI as a MODBUS Server

This chapter explains how to configure HMI as a MODBUS Server.

19.1. Overview.....	19-2
19.2. Steps to Create a MODBUS Server	19-2
19.3. Steps to Access a MODBUS Server	19-4
19.4. Changing MODBUS Server Station Number Online.....	19-6
19.5. MODBUS Address Type.....	19-6

19.1. Overview

Once the HMI is configured as a MODBUS device, the data of HMI can be read or written via MODBUS protocol.

As shown in the following figure, the HMI is configured as a MODBUS device (also called MODBUS Server). The HMI, PC or other devices can use MODBUS protocol to read or write HMI data via Ethernet or RS-232 / RS-485 interface.

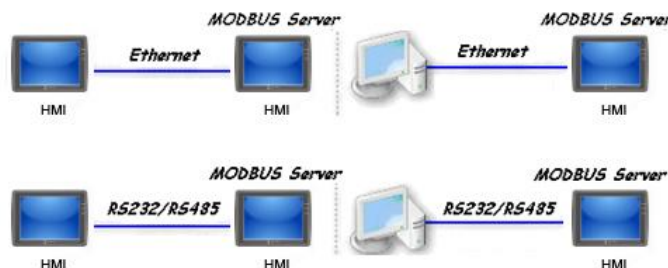

19.2. Steps to Create a MODBUS Server

1. To configure the HMI as a MODBUS device, add a new device in the device list first. Click [PLC type] drop-down box and select “MODBUS Server” driver. There are six selections for [PLC I/F]: RS-232 / RS-485 2W / RS-485 4W / Ethernet / USB / CAN. Choose the PLC interface appropriate for your PLC model.

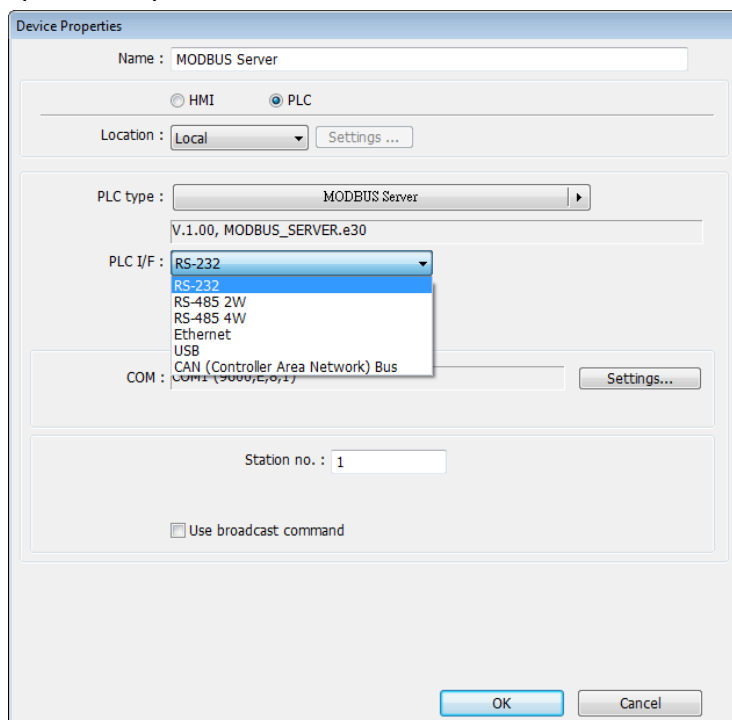

2. If [PLC I/F] is set to [RS-232] or [RS-485], please select [COM] (COM 1 ~ COM 3) and set correct communication parameters as shown in the following figure. MODBUS Server

[Station no.] is set to 1. Click [Settings], the maximum LW address range read / written by Modbus Client can be set. When the object in the project uses a LW register, the Modbus Client will not be able to read or write an address that is not within the specified range.

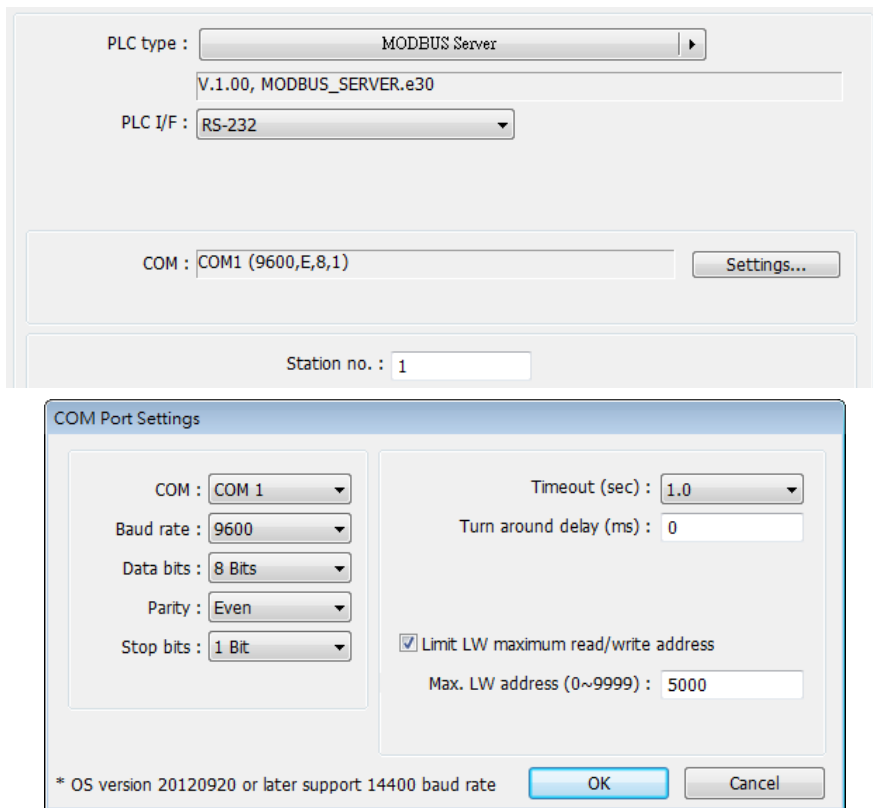

If [PLC I/F] is set to [Ethernet], please set [Port no.].

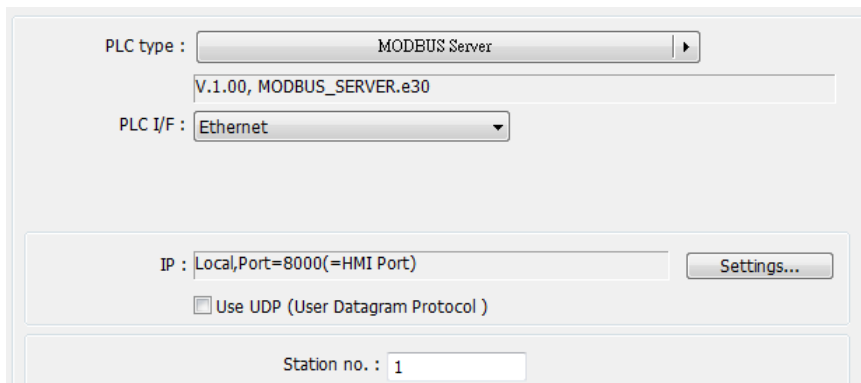

The [Port no.] of MODBUS Server and HMI must be the same. To change the port number, please set in the [Model] tab.

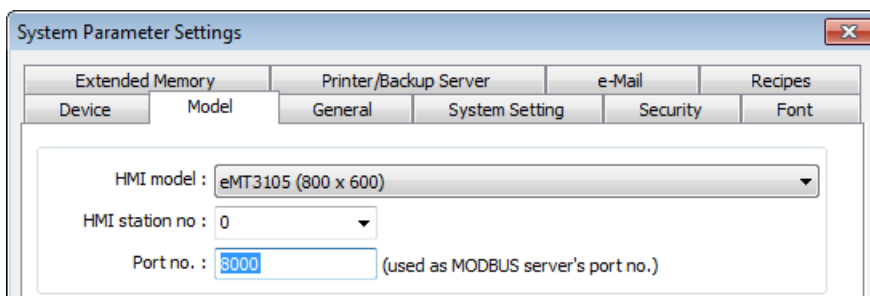

- When finished, MODBUS Server is listed in [Device] tab. The configuration of MODBUS device is completed. Compile the .empt file and download the compiled .exob file to the HMI, then HMI data can be read or written by using MODBUS protocol.

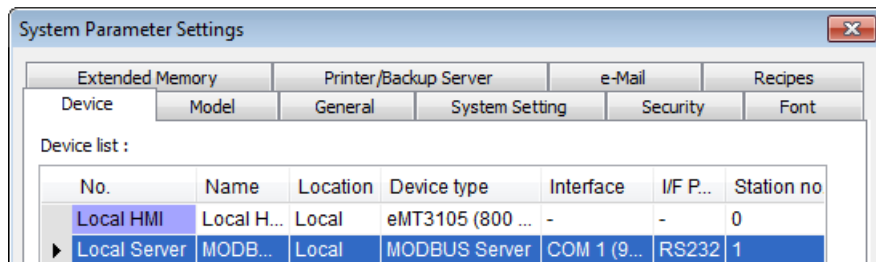

Note

- For cMT-SVR, if [Ethernet] PLC interface is chosen, then enter the port number.

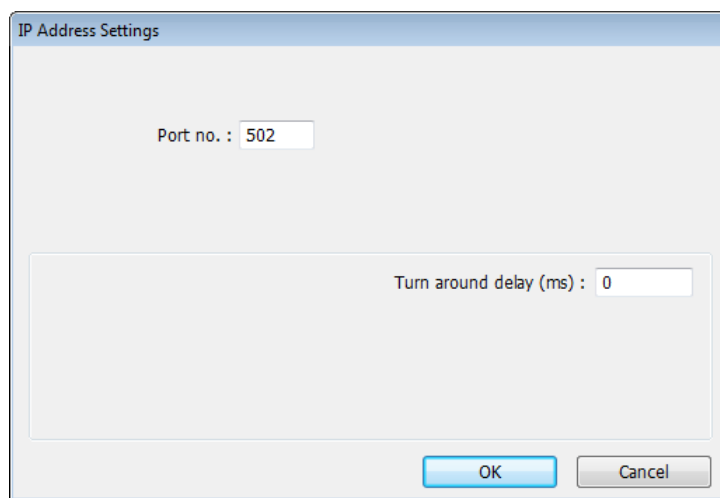

19.3. Steps to Access a MODBUS Server

Two HMIs can be configured as one MODBUS client and one MODBUS server to communicate and exchange data.

- Add a new device in client's device list. If the client chooses [Ethernet] PLC interface, set [PLC type] to "MODBUS TCP/IP" and fill in the correct [IP address] (the IP of MODBUS Server), [Port no.], and [Station no.].

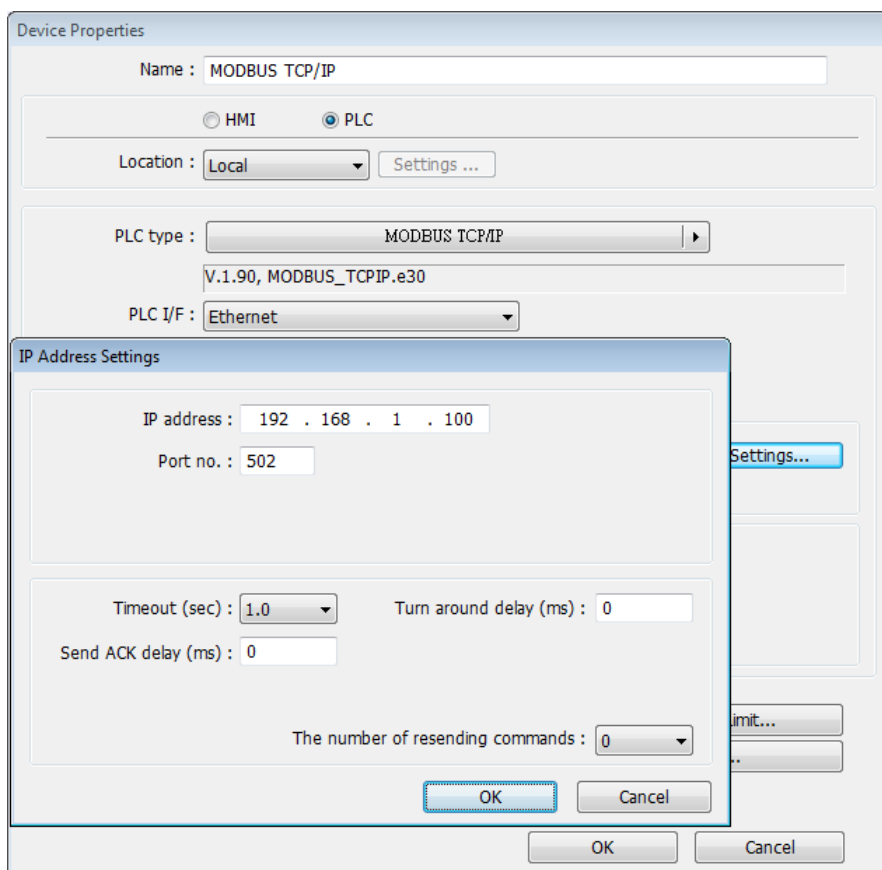

If the client chooses [RS-232] or [RS-485] PLC interface, the [PLC type] must be set to “MODBUS RTU”, and its communication parameters also must be configured correctly.

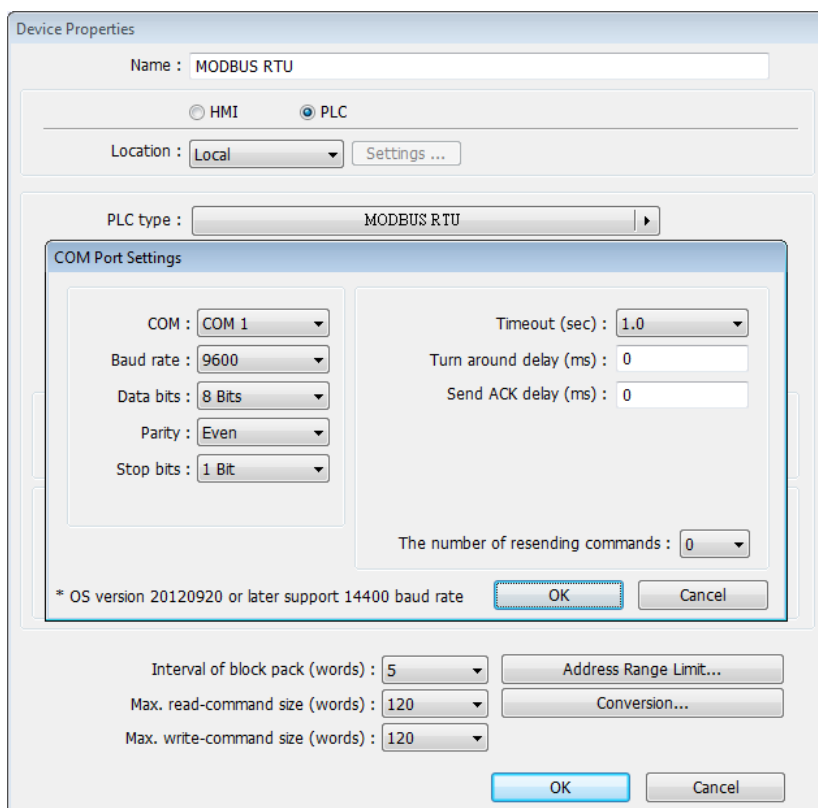

- When finished, click [OK], then a new device “MODBUS RTU” is listed in the [Device] tab.

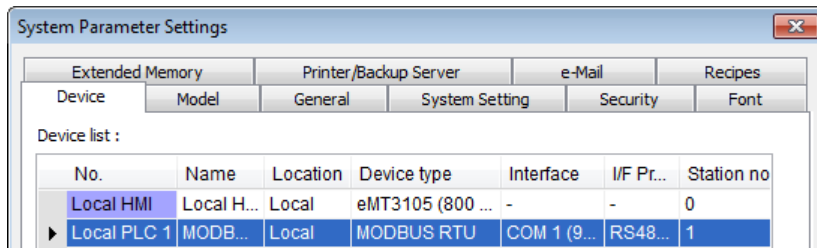

- In the setting page of each object, select “MODBUS RTU” in [PLC name], and set the address of MODBUS RTU.

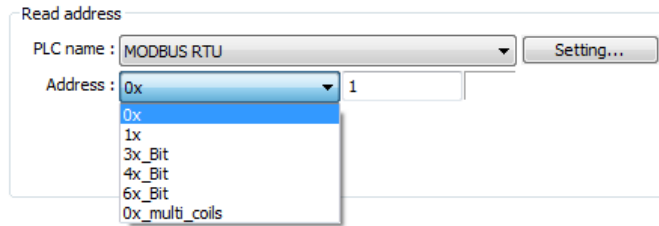

Since the server is an HMI, the corresponding read and write addresses are listed below :

0x/1x (1 ~ 12096)	LB (0 ~ 12095)
3x/4x/5x (1 ~ 9999)	LW (0 ~ 9998)
3x/4x/5x (10000 ~ 65535)	RW (0 ~ 55535)

19.4. Changing MODBUS Server Station Number Online

EasyBuilder Pro provides the following system registers to change MODBUS Server station number online.

LW-9541	MODBUS/ASCII server station no. (COM 1)
LW-9542	MODBUS/ASCII server station no. (COM 2)
LW-9543	MODBUS/ASCII server station no. (COM 3)
LW-9544	MODBUS/ASCII server station no. (Ethernet)

19.5. MODBUS Address Type

In the EasyBuilder Pro, the address types of MODBUS protocol are 0x, 1x, 3x, 4x, 5x, 6x, 3x_bit and 4x_bit. MODBUS RTU function codes are listed below:

0x: Coils	A read and write device type. When reading a bit with this device type, the function code is 01H. When writing a bit, the function code is 05H. When writing multiple bits, the function code is 0FH.
--------------	---

1x: Discrete Inputs	A read only device type. When reading a bit the function code is 02H.
3x: Input Registers	A read only device type. When reading data, the function code is 04H.
4x: Holding Register	A read and write device type. When reading data, the function code is 03H. When writing data, the function code is 10H.
5x	The function code is the same as 4x. The difference is that 5x makes double word swap when the format is 32-bit unsigned. If the data read by 4x is 0x1234, the data read by 5x is 0x3412.
6x	A read and write device type. When reading data, the function code is 03H. The difference from 4x is that when writing data, the function code is 06H, meaning to write a single register.
3x_bit	The function code is the same as 3x. The difference is that 3x_bit reads a single bit in the data.
4x_bit	The function code is the same as 4x. The difference is that 4x_bit reads a single bit in the data.



For more information, see “37 MODBUS TCP/IP Gateway”.

20. How to Connect a Barcode Reader

This chapter explains how to connect a Barcode reader and the relevant settings.

20.1. Overview.....	20-2
20.2. Steps to Connect a Barcode Reader	20-2

20.1. Overview

HMI can connect with barcode reader via the following interfaces:

- USB
- COM port

To connect a barcode reader, please add a new device by the following steps.

20.2. Steps to Connect a Barcode Reader

1. In EasyBuilder Pro » [Edit] » [System Parameter Settings] » [Device list], add a new device.

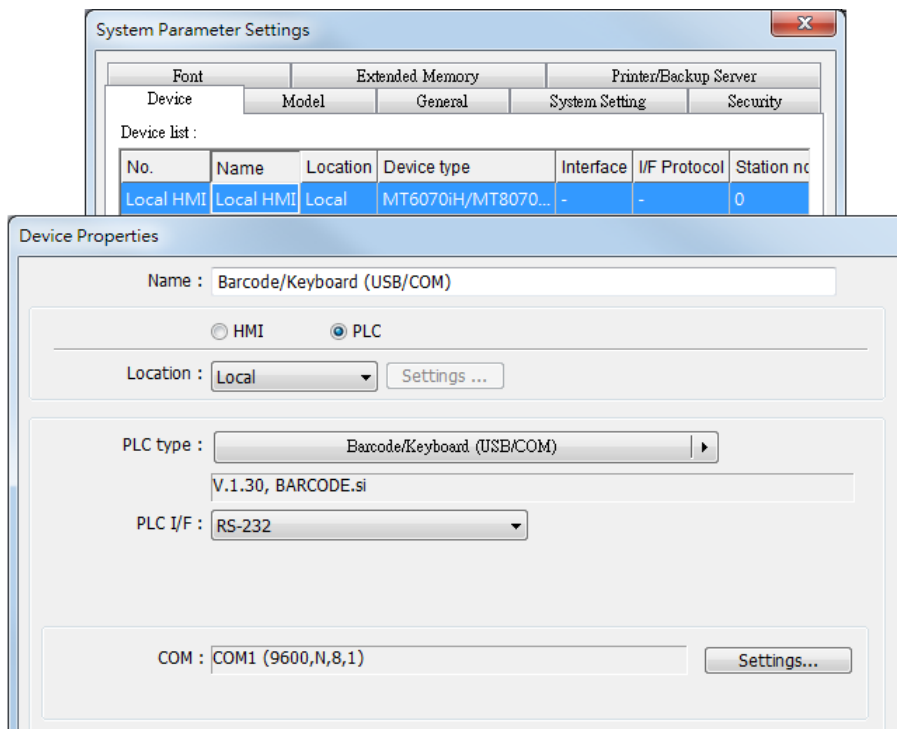

2. Click [Settings] and finish [Barcode Device / Keyboard Settings].

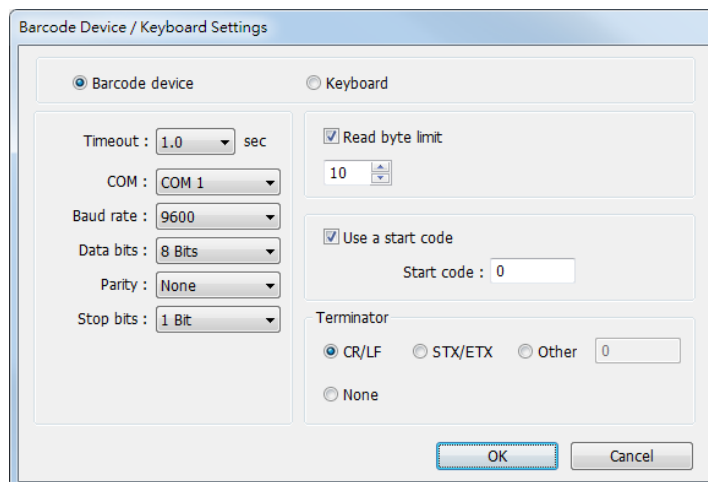

Setting	Description
Timeout	<p>When select [Barcode device], if the device reads slowly, a longer timeout is suggested to read data completely.</p> <p>When select [Keyboard], a time range can be set for keyboard entries. The system starts counting time from the first entry.</p>
COM Baud rate Data bits Parity Stop bits	<p>When using COM port, please set the communication parameters correctly.</p> <p>When using USB, there is no need to set the parameters.</p>
Read byte limit	<p>If this check box is selected, the number of bytes a barcode reader reads is restricted in order to prevent overloading. The range is 10 to 512.</p> <p>Please note that the data cannot be read if it exceeds the limit.</p>
Use a start code	<p>If this check box is selected, the data is only valid when the first data is identical to the start code, otherwise the data will be ignored. The start code will not be stored in the address of barcode reader.</p> <p>For example: if the start code is 255 (0xff), and the data read is:</p> <p>0xff 0x34 0x39 0x31 0x32 0x30 0x30 0x34 0x37</p> <p>The data saved in the designated barcode reader address will be:</p> <p>0x34 0x39 0x31 0x32 0x30 0x30 0x34 0x37</p>
Terminator	Terminator means the end of data. When a terminator is detected, it stands for the end of data stream.
CR/LF	0x0a or 0x0d stands for the end of data stream.
STX/ETX	0x02 or 0x03 stands for the end of data stream.
Other	Users can set the terminator.
None	If this check box is selected, HMI will save all the data to the designated address of barcode reader.

When finish setting, a new device is added to the [Device list].

Now the barcode reader can be selected in [PLC type] when creating an object. The address types are listed in the following table.

Address Type	Address Name	Description
Bit	FLAG	FLAG 0 indicates the status of data reading. When reading data, the status of FLAG 0 is set OFF and will return ON after reading successfully.
	RESET	RESET 0 clears the data of BARCODE and RESULT when set ON.
	CONNECT_STAT US	CONNECT_STATUS 0 indicates whether the barcode reader (USB interface) is connected. When the status is ON, the barcode reader is connected.
Word	BARCODE	BARCODE 0: Number of bytes currently read. BARCODE 1 ~ n: Stores the data read.
	RESULT	RESULT 0 indicates the result of data reading. The following codes indicate: 0x00 Waiting to read BARCODE. 0x01 BARCODE successfully read. 0x02 Invalid BARCODE format. 0x03 The number of bytes specified in [Read byte limit] exceeded. 0x04 The Start Code of the data read does not match the setting. 0x05 The Terminator of the data read does not match the setting.

Example 1

The following is a setting example, the barcode is 9421007480830. BARCODE 0 is the address of Numeric Display Object (BYTES) and BARCODE 1 ~ n is the address of ASCII Display object (BARCODE).

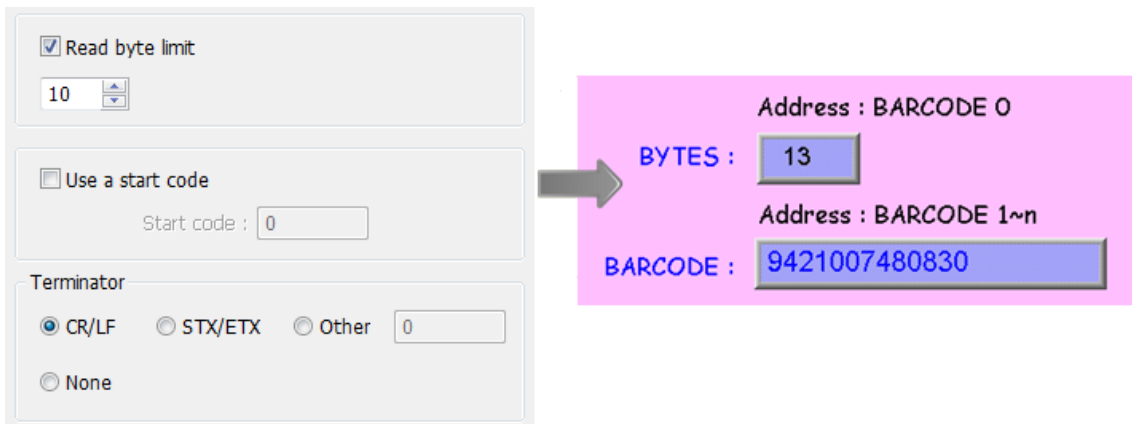

In the example the data stored in the barcode reader address is listed in the following table:

Barcode Reader Address	Data
BARCODE 0	13 bytes (decimal) However, the data saved is 14 bytes = 7 words. It is because when the number of bytes is an odd number, the system adds a byte (0x00) to make it an even number.
BARCODE 1	3439 (HEX)
BARCODE 2	3132 (HEX)
BARCODE 3	3030 (HEX)
BARCODE 4	3437 (HEX)
BARCODE 5	3038 (HEX)
BARCODE 6	3338 (HEX)
BARCODE 7	0030 (HEX)

Note

- HMI can only connect with one USB barcode reader. When the device list in the project includes this kind of device, the system register LB-9064: [enable USB barcode device (disable keyboard) (when ON)] is set ON. To enable USB keyboard again and stop using USB barcode reader, please set LB-9064 OFF.



Click the icon to download the demo project. Please confirm your internet connection.

21. Ethernet Communication and Multi-HMI Connection

This chapter explains how to connect multiple devices via Ethernet.

21.1. Overview.....	21-2
21.2. HMI to HMI Communication	21-2
21.3. PC to HMI Communication	21-3
21.4. Operate the PLC Connected with Other HMI	21-4

21.1. Overview

There are two ways of Ethernet communication:

- Use RJ45 straight through cable and hub.

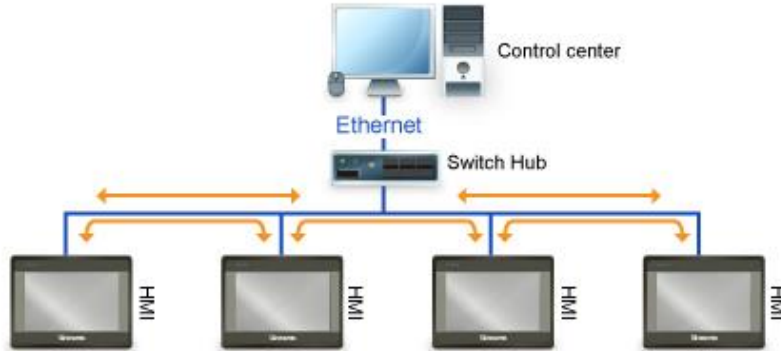

- Use RJ45 crossover cable and without hub, but this is limited to point-to-point connection (HMI to HMI or PC to HMI).

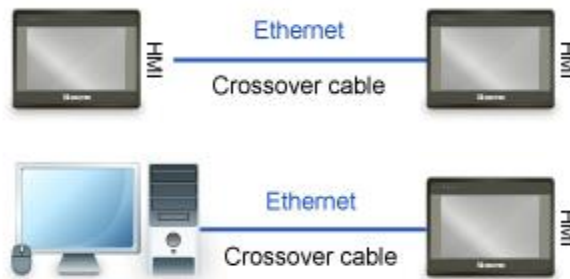

Through Ethernet network, the system provides the following methods for data transmission:

- HMI to HMI communication.
- PC to HMI communication.
- Operating the PLC connected to another HMI.

21.2. HMI to HMI Communication

To exchange data between one HMI and another HMI, add a new remote HMI device in [System Parameter Settings]. If there are 2 HMIs (HMI A and HMI B), in order to use a Set Bit object on HMI A to control [LB-0] on HMI B, the setting of the project of HMI A is explained in the following part.



1. Set the IP address of the two HMIs, for example, HMI A: 192.168.1.1, HMI B: 192.168.1.2.

- In [System Parameter Settings] » [Device list], add a remote HMI B (IP: 192.168.1.2).

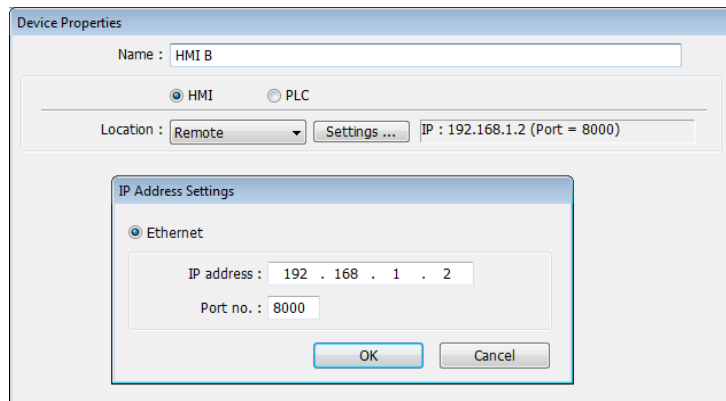

- Create a Set Bit Object, select "HMI B" in [PLC name] to control the address of the remote HMI.

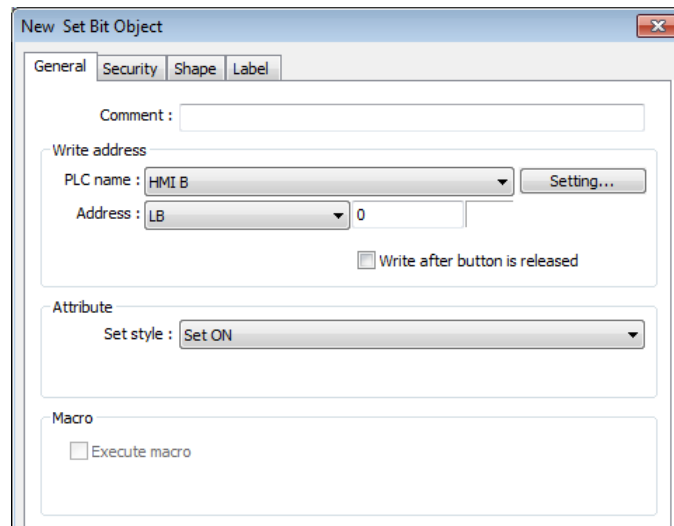

Note

- One HMI can handle requests from a maximum of 64 HMIs simultaneously.
- One cMT-SVR can handle requests from a maximum of 32 HMIs simultaneously.

21.3. PC to HMI Communication

With On-line Simulation, PC can collect data from HMI through Ethernet network and save the data files to PC. To connect PC with two HMIs (HMI A and HMI B), the setting of the project on PC is explained in the following part.



- Set the IP address of the two HMIs, for example, HMI A: 192.168.1.1, HMI B: 192.168.1.2.
- In [System Parameter Settings] » [Device list], add a remote HMI A (IP: 192.168.1.1) & HMI

B (IP: 192.168.1.2).

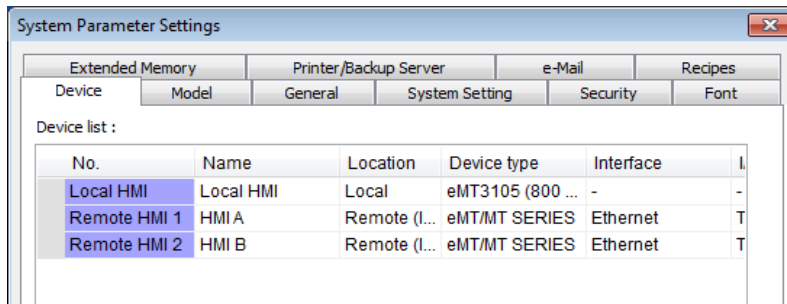

3. Create a Set Bit Object, select "HMI A" in [PLC name] to control the address of the remote HMI A. Same for the HMI B.

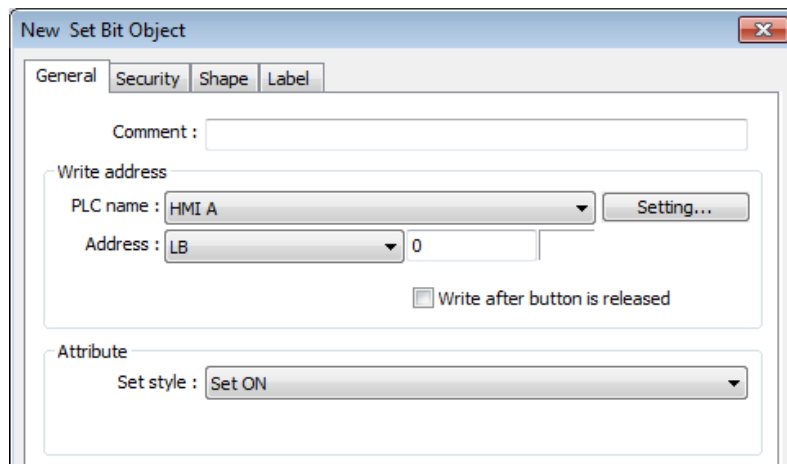

Note

- A PC can control at most 64 HMIs simultaneously.
- As shown above, HMI can also control PC. PC can be seen as another HMI, that is, adding a remote HMI in the project of HMI A / HMI B, and the IP of the remote HMI is set to the IP of PC.

21.4. Operating the PLC Connected with Other HMI

Through Ethernet network, PC or HMI can operate the PLC that is connected to another HMI. If PLC is connected to COM 1 of HMI B, when using PC or HMI A to read PLC data, the setting of the project of PC or HMI A is explained in the following part.

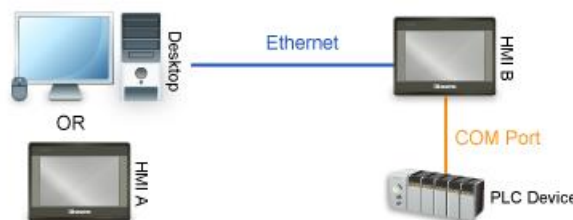

21.4.1. Settings of eMT / mTV Series

1. Set the IP address of HMI B, for example, 192.168.1.2.
2. In [System Parameter Settings] » [Device list], add a remote PLC, and set [Name] to “PLC on HMI B”. Set correct parameters. Since this PLC is connected to remote HMI B, set the IP address to HMI B (IP: 192.168.1.2).

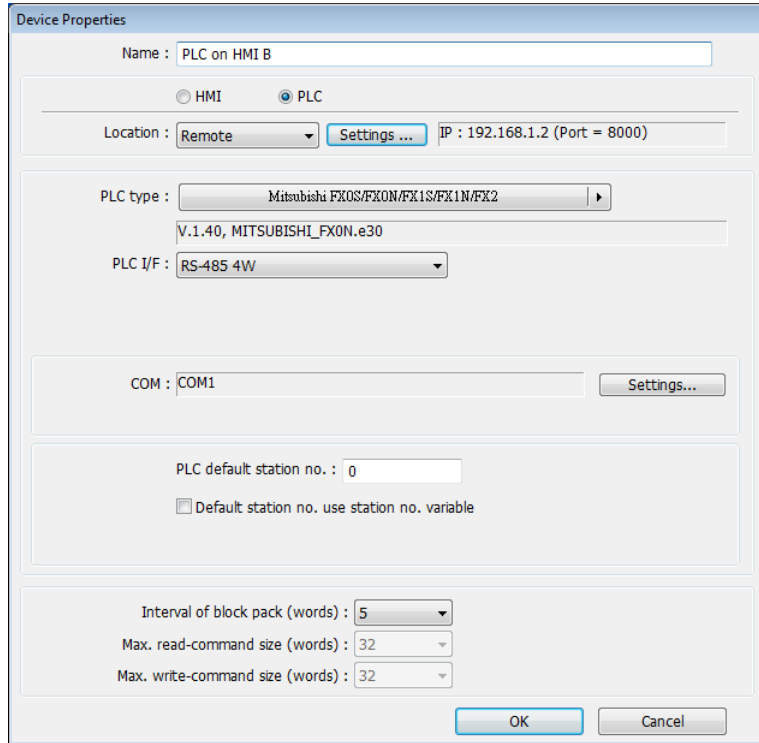

3. Create a Set Bit Object, select “PLC on HMI B” in [PLC name] to control the PLC connected with the remote HMI B.

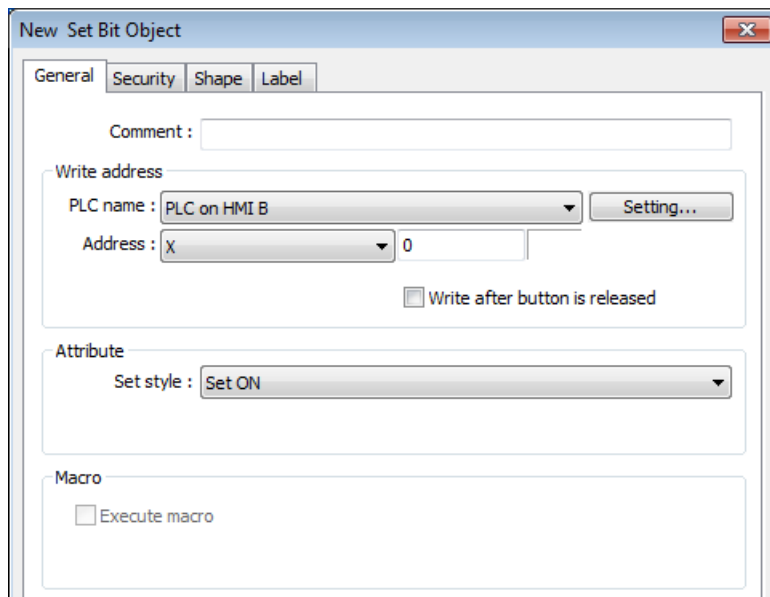

21.4.2. Settings of cMT-SVR Series

1. Set the IP address of HMI B, for example, 192.168.1.2.
2. In [System Parameter Settings] » [Device list], click [New HMI]. Set the IP address to HMI B (IP: 192.168.1.2).

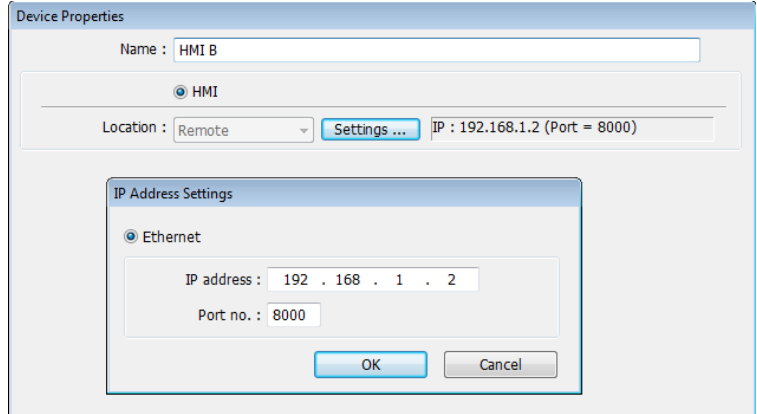

3. In the project of HMI B, go to [System Parameter Settings] » [Device list], click [New PLC], set [Name] to “PLC on HMI B”. Set correct parameters.

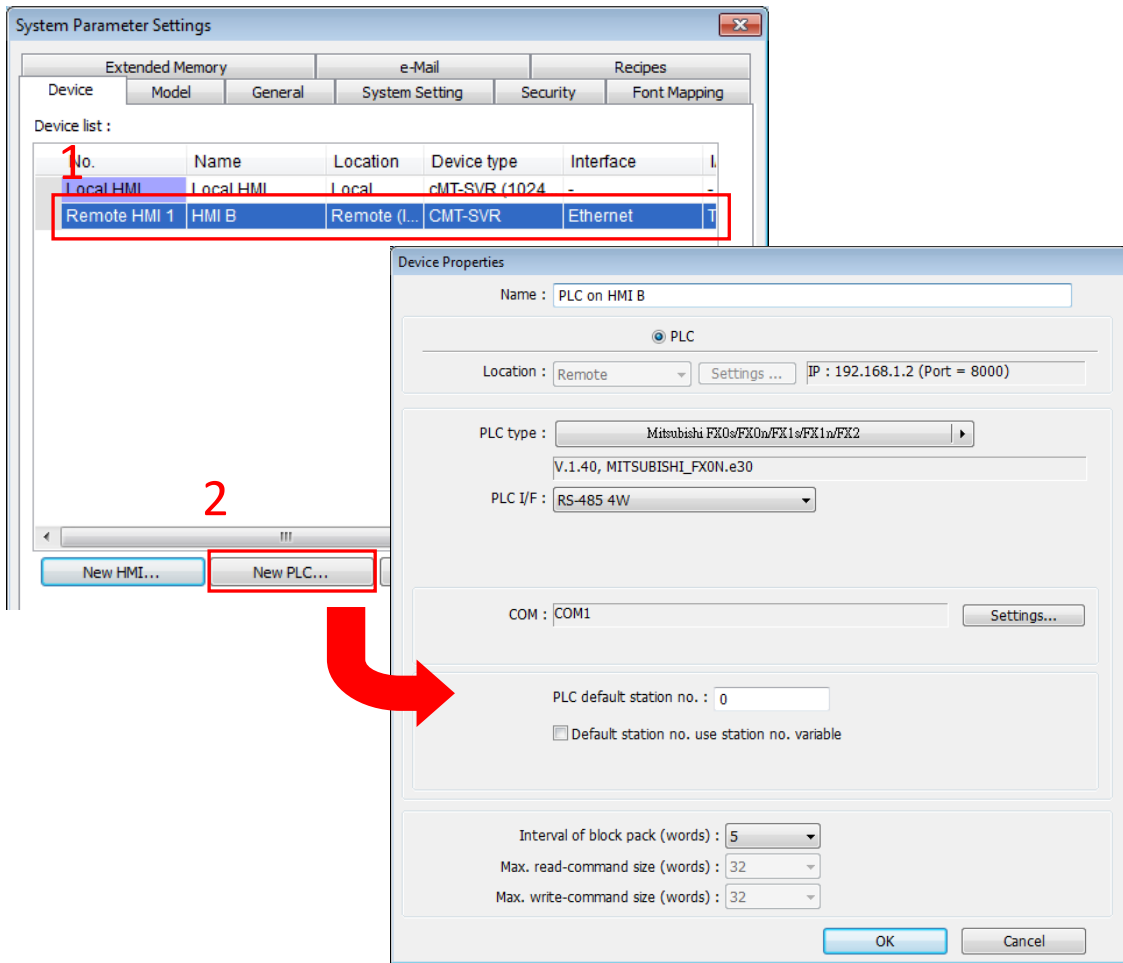

4. When finished, a remote PLC can be found under Remote HMI 1. Local HMI 1 stands for HMI A, Remote HMI 1 stands for HMI B, and Remote PLC 1 is connected with HMI B.

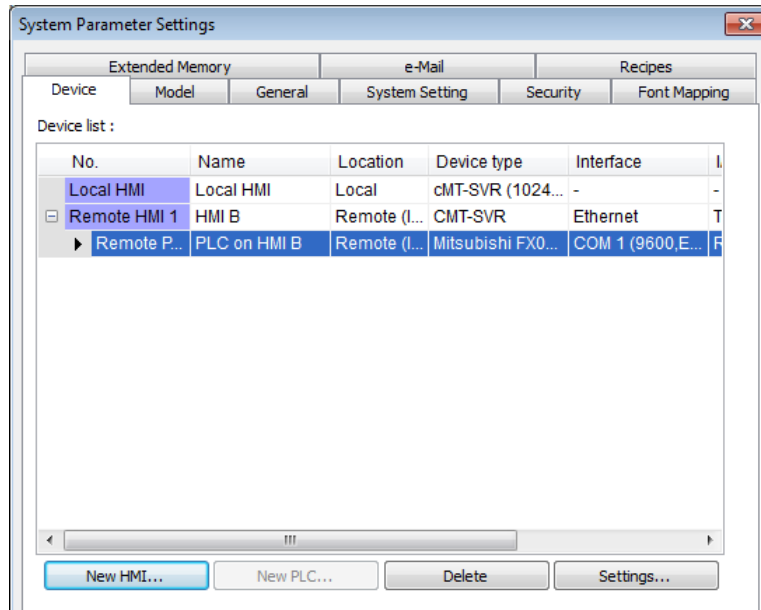

5. Create a Set Bit Object, select "PLC on HMI B" in [PLC name] to control the PLC connected with the remote HMI B.

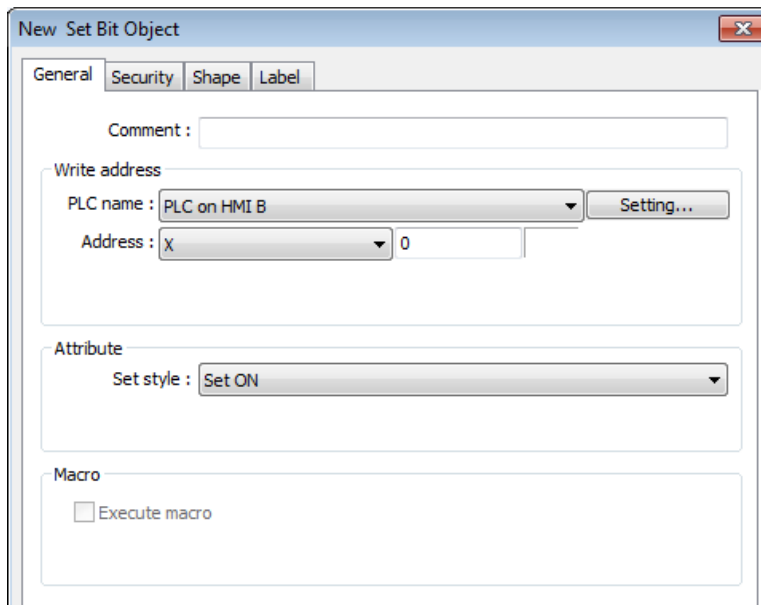

Note

- Remote HMI in a cMT-SVR project must be a cMT-SVR machine. Thus, a cMT-SVR cannot communicate with PLCs connected with other series, such as eMT, mTV-series.

22. System Registers

This chapter introduces different types of registers.

22.1. Overview	22-3
22.2. The Address Ranges of Local HMI	22-4
22.2.1. Bits	22-4
22.2.2. Words.....	22-4
22.3. System Registers	22-5
22.3.1. HMI Time	22-5
22.3.2. HMI Operation	22-6
22.3.3. Touch Position.....	22-7
22.3.4. Local HMI Network Information	22-7
22.3.5. Project File Information	22-9
22.3.6. Storage Space Management.....	22-10
22.3.7. Recipe and Extended Memory	22-10
22.3.8. Data Sampling.....	22-11
22.3.9. Event Log.....	22-12
22.3.10. Station Number Variables.....	22-13
22.3.11. Index Registers.....	22-14
22.3.12. MODBUS Server Communication	22-15
22.3.13. Communication Parameter Settings.....	22-16
22.3.14. Communication Status and Control with PLC (COM)	22-19
22.3.15. Communication Status and Control with PLC (Ethernet)	22-20
22.3.16. Communication Status and Control with PLC (USB).....	22-22
22.3.17. Communication Status and Control with PLC (CAN Bus).....	22-23
22.3.18. Communication Status and Control with Remote HMI	22-23
22.3.19. Communication Status and Control with Remote PLC	22-27
22.3.20. Local/Remote Operation Restrictions	22-29
22.3.21. Communication Error Codes.....	22-29
22.3.22. Driver ID.....	22-31
22.3.23. DLT645 Controller	22-31
22.3.24. [PLC No Response] Window Control	22-31
22.3.25. [Fast Selection] Window Control	22-32
22.3.26. EasyAccess	22-32
22.3.27. EasyAccess 2.0	22-32

22.3.28. Remote Print/Backup Server	22-33
22.3.29. Pass-Through Settings.....	22-33
22.3.30. VNC Control	22-34
22.3.31. Project Key and HMI Key	22-35
22.3.32. USB Security Key	22-35
22.3.33. User Name and Password.....	22-36
22.3.34. Macro.....	22-37
22.3.35. Input Object Function.....	22-38
22.3.36. Time Sync./Daylight Saving Time.....	22-38
22.3.37. Cellular Data Network	22-40
22.3.38. Wi-Fi Setting	22-40
22.3.39. OPC UA Server	22-42
22.3.40. e-Mail.....	22-42
22.3.41. Miscellaneous.....	22-44

22.1. Overview

Some Word and Bit addresses are reserved in EasyBuilder Pro. These registers are reserved for different functions. This chapter introduces different types of registers.

The “C” letter in the register tables stands for “Control”, which means that this register not only allows write operation, but also can be controlled by Macro or a remote HMI.

When using a cMT Series model, the PLW and PLB registers can be selected. LW/LB are local registers whereas PLW/PLB are client registers. The client device can be: cMT-iV5, iPad, Android device...etc. When connecting a cMT Series model with one or multiple client devices, the PLW/PLB registers can be set on the client devices.

No.	Address tag name	PLC name	Address	Read/W...	Comment
1	LB-9000 : initialized as ON	Local HMI	Bit LB-9000	Read/...	
2	LB-9001 : initialized as ON	Local HMI	Bit LB-9001	Read/...	
3	LB-9002 : initialized as ON	Local HMI	Bit LB-9002	Read/...	
4	LB-9003 : initialized as ON	Local HMI	Bit LB-9003	Read/...	
5	LB-9004 : initialized as ON	Local HMI	Bit LB-9004	Read/...	
6	LB-9005 : initialized as ON	Local HMI	Bit LB-9005	Read/...	
7	LB-9006 : initialized as ON	Local HMI	Bit LB-9006	Read/...	
8	LB-9007 : initialized as ON	Local HMI	Bit LB-9007	Read/...	
9	LB-9008 : initialized as ON	Local HMI	Bit LB-9008	Read/...	
10	LB-9009 : initialized as ON	Local HMI	Bit LB-9009	Read/...	
11	LB-9010 : data download indicator	Local HMI	Bit LB-9010	Read ...	
12	LB-9011 : data upload indicator	Local HMI	Bit LB-9011	Read ...	
13	LB-9012 : data download/uploa...	Local HMI	Bit LB-9012	Read ...	
14	LB-9013 : FS window control[hi...	Local HMI	Bit LB-9013	Read/...	
15	LB-9014 : FS button control[hid...	Local HMI	Bit LB-9014	Read/...	
16	LB-9015 : FS window/button c...	Local HMI	Bit LB-9015	Read/...	
17	LB-9016 : status is on when a cl...	Local HMI	Bit LB-9016	Read/...	
18	LB-9017 : disable write-back in ...	Local HMI	Bit LB-9017	Read/...	
19	LB-9018 : disable mouse cursor ...	Local HMI	Bit LB-9018	Read/...	
20	LB-9019 : disable/enable button	Local HMI	Bit LB-9019	Read/...	

22.2. The Address Ranges of Local HMI

22.2.1. Bits

Register	Device Type	Range	Format
Local Bits	LB	0 ~ 12399	DDDDD
Client Bits	PLB	0 ~ 12399	DDDDD
Local Word Bits	LW_Bit	0 ~ 1130015	DDDDDdd DDDDD: address dd: bit no. (00 ~ 15)
Client Word Bits	PLW_Bit	0 ~ 1079915	DDDDDdd DDDDD: address dd: bit no. (00 ~ 15)
Retentive Bit Index	RBI	0 ~ 65535f	DDDDDh DDDDD: address h: bit no. (0 ~ f) Use LW-9000 as Index Register, and correspond to RW_Bit
Retentive Word Bits	RW_Bit	0 ~ 524287f	DDDDDh DDDDD: address h: bit no. (0 ~ f)
Retentive A Word Bits	RW_A_Bit	0 ~ 65535f	DDDDDh DDDDD: address h: bit no. (0 ~ f)

22.2.2. Words

Register	Device Type	Range	Format
Local Words	LW	0 ~ 11300	DDDDD
Client Words	PLW	0 ~ 10799	DDDDD
Retentive Words	RW	0 ~ 524287	DDDDDD
Retentive A Words	RW_A	0 ~ 65535	DDDDD
Retentive Word Index	RWI	0 ~ 65535	DDDDD Use LW-9000 as Index Register, and correspond to RW
Extended Memory Words	EM0 ~ EM9	0 ~ 1073741823	DDDDDDDDDD

22.3. System Registers

22.3.1. HMI Time

Address	Description	Read(R)/Write(W)/Control(C)		
		Local HMI	Macro	Remote HMI
LB-11958	time setting error (when ON) *Note 3	R	R	R
LW-9010	(16bit-BCD) : local second	R/W	R/C	R/C
LW-9011	(16bit-BCD) : local minute	R/W	R/C	R/C
LW-9012	(16bit-BCD) : local hour	R/W	R/C	R/C
LW-9013	(16bit-BCD) : local day	R/W	R/C	R/C
LW-9014	(16bit-BCD) : local month	R/W	R/C	R/C
LW-9015	(16bit-BCD) : local year	R/W	R/C	R/C
LW-9016	(16bit-BCD) : local week	R	R	R
LW-9017	(16bit) : local second	R/W	R/C	R/C
LW-9018	(16bit) : local minute	R/W	R/C	R/C
LW-9019	(16bit) : local hour	R/W	R/C	R/C
LW-9020	(16bit) : local day	R/W	R/C	R/C
LW-9021	(16bit) : local month	R/W	R/C	R/C
LW-9022	(16bit) : local year *Note 1	R/W	R/C	R/C
LW-9023	(16bit) : local week *Note 2	R	R	R
LW-9030	(32bit) : system time (unit : 0.1 second)	R	R	R
LW-9048	(16bit) : time (0 : AM, 1 : PM)	R/W	R/C	R/C
LW-9049	(16bit) : local hour (12-hour format)	R/W	R/C	R/C

Note

1. Value range: 2000 ~ 2037.
2. Value range: 0 ~ 6, stand for Sunday ~ Saturday.
3. When use LW-9010 to LW-9023 to update RTC time, the system will check if RTC time is successfully updated. If the system still fails to update RTC time, the system register [LB-11958: time setting error] will be set ON, and restore to the time before update. Updating time on PC during simulation by using LW-9010 to LW-9023 is ineffective.

22.3.2. HMI Operation

Address	Description	Read(R)/Write(W)/Control(C)		
		Local HMI	Macro	Remote HMI
LB-9018	disable(set ON)/enable (set OFF) mouse cursor	R/W	R/C	R/C
LB-9019	disable(set ON)/enable (set OFF) buzzer	R/W	R/C	R/C
LB-9020	show (set ON)/ hide (set OFF) system setting bar	R/W	R/C	R/C
LB-9033	disable(when on)/enable (when off) HMI upload function <i>*Note 1</i>	R/W	R/C	R
LB-9040	backlight up (set ON) <i>*Note 2</i>	W	C	C
LB-9041	backlight down (set ON) <i>*Note 2</i>	W	C	C
LB-9047	reboot HMI (set ON when LB-9048 is on)	W	C	C
LB-9048	reboot-HMI protection	R/W	R/C	R/C
LB-9062	open hardware setting dialog (set ON)	W	C	C
LB-9063	disable(set ON)/enable(set OFF) popping information dialog while finding an USB disk	R/W	R/C	R/C
LB-9064	enable USB barcode device (disable keyboard) (when ON) <i>*Note 5</i>	R/W	R/C	R
LB-11959	LED indicator control <i>*Note 4</i>	R/W	R/C	R/C
LB-12042	open/close [System information] dialog (set ON/set OFF)	R/W	R/C	R/C
LB-12051	buzzer status (active when ON)	R/W	R/C	R/C
LB-12360	CPU loading alarm (> 95%) <i>*Note 6</i>	R	R	R
LW-9007	(16bit) : hardware index	R	R	R
LW-9008	(32bit-float) : battery voltage <i>*Note 3</i>	R	R	R
LW-9025	(16bit) : CPU loading (x 100%)	R	R	R
LW-9026	(16bit) : OS version (year)	R	R	R
LW-9027	(16bit) : OS version (month)	R	R	R
LW-9028	(16bit) : OS version (day)	R	R	R
LW-9040	(16bit) : backlight index <i>*Note 2</i>	R	R	R
LW-9051	(16bit) : audio volume (0 ~100)	R/W	R/C	R/C
LW-9054	(32bit) : HMI model ID	R	R	R
LW-9080	(16bit) : backlight saver time (unit : minute)	R/W	R/C	R/C
LW-9081	(16bit) : screen saver time (unit : minute)	R/W	R/C	R/C
LW-9141	(16bit) : HMI station no.	R/W	R/C	R/C
LW-9199	(16bit) : external keyboard layout : 0 (QWERTY), 1 (AZERTY)	R/W	R/C	R/C
LW-9350	(16bit) : pending command no. in local HMI	R	R	R
LW-10884	(16 words) : HMI name	R/W	R/C	R/C
LW-11155	(32bit) : the total size of HMI memory (unit : KB)	R	R	R
LW-11157	(32bit) : the free size of HMI memory (unit : KB)	R	R	R

LW-11159	(16bit) : memory loading (x 100%)	R	R	R
LW-11382	(16bit) : DIP switch status (bit 0 : DIP 1, bit 1 : DIP 2, bit 2 : DIP 3)	R	R	R

Note

1. After changing the settings, please reboot HMI for the updates to take effect.
2. Use LW-9040 together with LB-9040 ~ LB-9041 to adjust the backlight brightness, range: 0 ~ 31.
3. Only supported by eMT Series. When the battery voltage level, indicated by LW-9008, drops below 2.8V, battery replacement is recommended.
4. When multiple mTV or cMT-SVR devices are used, this register can be triggered to make the LED indicator blink for identifying the device.
5. LB-9064: Enable USB barcode device (disable keyboard).



Click the icon to download the demo project. Please confirm your internet connection.

6. This register will be set to ON if CPU loading remains over 95% for 30 seconds.

22.3.3. Touch Position

Address	Description	Read(R)/Write(W)/Control(C)		
		Local HMI	Macro	Remote HMI
LW-9041	(16bit) : touch status word(bit 0 on = user is touching the screen)	R	R	R
LW-9042	(16bit) : touch x position	R	R	R
LW-9043	(16bit) : touch y position	R	R	R
LW-9044	(16bit) : leave x position	R	R	R
LW-9045	(16bit) : leave y position	R	R	R



Click the icon to download the demo project that explains how to how to trigger relevant registers to change page with finger slide. Please confirm your internet connection.

22.3.4. Local HMI Network Information

Address	Description	Read(R)/Write(W)/Control(C)		
		Local HMI	Macro	Remote HMI
LB-12041	refresh HMI ethernet information (DHCP, gateway, netmask, IP) (set ON)	R/W	R/C	R/C
LB-12094	update ethernet 1 setting (IP, netmask, gateway) (set ON)	R/W	R/C	R/C
LB-12095	update ethernet 2 setting (IP, netmask) (set ON)	R/W	R/C	R/C
LW-9125	(16bit) : HMI ethernet 1 gateway 0 (machine used only)	R/W	R/C	R/C

LW-9126	(16bit) : HMI ethernet 1 gateway 1 (machine used only)	R/W	R/C	R/C
LW-9127	(16bit) : HMI ethernet 1 gateway 2 (machine used only)	R/W	R/C	R/C
LW-9128	(16bit) : HMI ethernet 1 gateway 3 (machine used only)	R/W	R/C	R/C
LW-9129	(16bit) : HMI ethernet 1 IP 0 (machine used only)	R/W	R/C	R/C
LW-9130	(16bit) : HMI ethernet 1 IP 1 (machine used only)	R/W	R/C	R/C
LW-9131	(16bit) : HMI ethernet 1 IP 2 (machine used only)	R/W	R/C	R/C
LW-9132	(16bit) : HMI ethernet 1 IP 3 (machine used only)	R/W	R/C	R/C
LW-9133	(16bit) : ethernet port no.	R	R	R
LW-9135	(16bit) : HMI media access control (MAC) address 0	R	R	R
LW-9136	(16bit) : HMI media access control (MAC) address 1	R	R	R
LW-9137	(16bit) : HMI media access control (MAC) address 2	R	R	R
LW-9138	(16bit) : HMI media access control (MAC) address 3	R	R	R
LW-9139	(16bit) : HMI media access control (MAC) address 4	R	R	R
LW-9140	(16bit) : HMI media access control (MAC) address 5	R	R	R
LW-10750	(16bit) : HMI ethernet 1 Mask 0 (machine used only)	R/W	R/C	R/C
LW-10751	(16bit) : HMI ethernet 1 Mask 1 (machine used only)	R/W	R/C	R/C
LW-10752	(16bit) : HMI ethernet 1 Mask 2 (machine used only)	R/W	R/C	R/C
LW-10753	(16bit) : HMI ethernet 1 Mask 3 (machine used only)	R/W	R/C	R/C
LW-10786	(16bit) : HMI ethernet 2 IP 0 (machine used only)	R/W	R/C	R/C
LW-10787	(16bit) : HMI ethernet 2 IP 1 (machine used only)	R/W	R/C	R/C
LW-10788	(16bit) : HMI ethernet 2 IP 2 (machine used only)	R/W	R/C	R/C
LW-10789	(16bit) : HMI ethernet 2 IP 3 (machine used only)	R/W	R/C	R/C
LW-10790	(16bit) : HMI ethernet 2 netmask 0 (machine used only)	R/W	R/C	R/C
LW-10791	(16bit) : HMI ethernet 2 netmask 1 (machine used only)	R/W	R/C	R/C
LW-10792	(16bit) : HMI ethernet 2 netmask 2 (machine used only)	R/W	R/C	R/C
LW-10793	(16bit) : HMI ethernet 2 netmask 3 (machine used only)	R/W	R/C	R/C
LW-10794	(16bit) : HMI ethernet 2 gateway 0 (machine used only)	R/W	R/C	R/C
LW-10795	(16bit) : HMI ethernet 2 gateway 1 (machine used only)	R/W	R/C	R/C
LW-10796	(16bit) : HMI ethernet 2 gateway 2 (machine used only)	R/W	R/C	R/C
LW-10797	(16bit) : HMI ethernet 2 gateway 3 (machine used only)	R/W	R/C	R/C
LW-10798	(16bit) : ethernet 2 media access control (MAC) address 0	R	R	R
LW-10799	(16bit) : ethernet 2 media access control (MAC) address 1	R	R	R
LW-10800	(16bit) : ethernet 2 media access control (MAC) address 2	R	R	R
LW-10801	(16bit) : ethernet 2 media access control (MAC) address 3	R	R	R
LW-10802	(16bit) : ethernet 2 media access control (MAC) address 4	R	R	R
LW-10803	(16bit) : ethernet 2 media access control (MAC) address 5	R	R	R
LW-10804	(16bit) : HMI ethernet 1 domain name system (DNS) server	R	R	R

	IPO			
LW-10805	(16bit) : HMI Ethernet 1 domain name system (DNS) server IP1	R	R	R
LW-10806	(16bit) : HMI Ethernet 1 domain name system (DNS) server IP2	R	R	R
LW-10807	(16bit) : HMI Ethernet 1 domain name system (DNS) server IP3	R	R	R
LW-10808	(16bit) : HMI ethernet 2 domain name system (DNS) server IPO	R	R	R
LW-10809	(16bit) : HMI ethernet 2 domain name system (DNS) server IP1	R	R	R
LW-10810	(16bit) : HMI ethernet 2 domain name system (DNS) server IP2	R	R	R
LW-10811	(16bit) : HMI ethernet 2 domain name system (DNS) server IP3	R	R	R
LW-10812	(16bit) : obtain an IP address automatically (DHCP => 0 : off, 1 : on)	R/W	R/C	R/C
LW-10813	(16bit) : obtain an ethernet 2 IP address automatically (DHCP => 0 : off, 1 : on)	R/W	R/C	R/C
LW-10815	(16bit) : link speed of ethernet 1 (0:failure, 10 (10M), 100 (100M), 1000 (1G))	R	R	R
LW-10816	(16bit) : link speed of ethernet 2 (0:failure, 10 (10M), 100 (100M), 1000 (1G))	R	R	R

 **Note**

- Registers relevant to Ethernet 2 are only available for cMT-SVR model.

22.3.5. Project File Information

Address	Description	Read(R)/Write(W)/Control(C)		
		Local HMI	Macro	Remote HMI
LW-9100	(16bit) : project name (16 words)	R	R	R
LW-9116	(32bit) : project size in bytes	R	R	R
LW-9118	(32bit) : project size in K bytes	R	R	R
LW-9120	(32bit) : compiler version	R	R	R
LW-9122	(16bit) : project compiled date [year]	R	R	R
LW-9123	(16bit) : project compiled date [month]	R	R	R
LW-9124	(16bit) : project compiled date [day]	R	R	R

LW-11440	(16bit) : project compiled time [hour] (24-hour format)	R	R	R
LW-11441	(16bit) : project compiled time [minute]	R	R	R
LW-11442	(16bit) : project compiled time [second]	R	R	R

22.3.6. Storage Space Management

Address	Description	Read(R)/Write(W)/Control(C)		
		Local HMI	Macro	Remote HMI
LB-9035	HMI free space insufficiency alarm (when ON)	R	R	R
LB-9036	SD card free space insufficiency alarm (when ON)	R	R	R
LB-9037	USB disk free space insufficiency alarm (when ON)	R	R	R
LB-12048	USB disk status (exists when ON)	R	R	R
LB-12050	SD card status (exists when ON)	R	R	R
LW-9070	(16bit) : free space insufficiency warning (Mega bytes)	R	R	R
LW-9071	(16bit) : reserved free space size (Mega bytes)	R	R	R
LW-9072	(32bit) : HMI current free space (K bytes)	R	R	R
LW-9074	(32bit) : SD current free space (K bytes)	R	R	R
LW-9076	(32bit) : USB disk current free space (K bytes)	R	R	R
LW-11458	(32bit) : HMI total space for history data (K bytes)	R	R	R
LW-11460	(32bit) : HMI current free space for history data (K bytes)	R	R	R



Click the icon to download the demo project that explains how to use LW-9072 ~ LW-9076 with Backup Object. Please confirm your internet connection.

22.3.7. Recipe and Extended Memory

Address	Description	Read(R)/Write(W)/Control(C)		
		Local HMI	Macro	Remote HMI
LB-9028	reset all recipe data (set ON)	W	C	C
LB-9029	save all recipe data to machine (set ON)	W	C	C
LB-9460	EM0's storage device (SD card) does not exist (when ON)	R	R	R
LB-9461	EM1's storage device (SD card) does not exist (when ON)	R	R	R
LB-9462	EM2's storage device (SD card) does not exist (when ON)	R	R	R
LB-9463	EM3's storage device (SD card) does not exist (when ON)	R	R	R
LB-9464	EM4's storage device (SD card) does not exist (when ON)	R	R	R
LB-9465	EM5's storage device (SD card) does not exist (when ON)	R	R	R
LB-9466	EM6's storage device (SD card) does not exist (when ON)	R	R	R

LB-9467	EM7's storage device (SD card) does not exist (when ON)	R	R	R
LB-9468	EM8's storage device (SD card) does not exist (when ON)	R	R	R
LB-9469	EM9's storage device (SD card) does not exist (when ON)	R	R	R
LB-9470	EM0's storage device (USB disk) does not exist (when ON)	R	R	R
LB-9471	EM1's storage device (USB disk) does not exist (when ON)	R	R	R
LB-9472	EM2's storage device (USB disk) does not exist (when ON)	R	R	R
LB-9473	EM3's storage device (USB disk) does not exist (when ON)	R	R	R
LB-9474	EM4's storage device (USB disk) does not exist (when ON)	R	R	R
LB-9475	EM5's storage device (USB disk) does not exist (when ON)	R	R	R
LB-9476	EM6's storage device (USB disk) does not exist (when ON)	R	R	R
LB-9477	EM7's storage device (USB disk) does not exist (when ON)	R	R	R
LB-9478	EM8's storage device (USB disk) does not exist (when ON)	R	R	R
LB-9479	EM9's storage device (USB disk) does not exist (when ON)	R	R	R

22.3.8. Data Sampling

Address	Description	Read(R)/Write(W)/Control(C)		
		Local HMI	Macro	Remote HMI
LB-9025	delete the earliest data sampling file on HMI memory (set ON)	W	C	C
LB-9026	delete all data sampling files on HMI memory (set ON)	W	C	C
LB-9027	refresh data sampling information on HMI memory (set ON)	W	C	C
LB-9034	save event/data sampling to HMI, USB disk, SD card (set ON) *Note 1	W	C	C
LB-11949	delete the earliest data sampling file on SD card (set ON)	W	C	C
LB-11950	delete all data sampling files on SD card (set ON)	W	C	C
LB-11951	refresh data sampling information on SD card (set ON)	W	C	C
LB-11952	delete the earliest data sampling file on USB disk (set ON)	W	C	C
LB-11953	delete all data sampling files on USB disk (set ON)	W	C	C
LB-11954	refresh data sampling information on USB disk (set ON)	W	C	C
LW-9063	(16bit) : no. of data sampling files on HMI memory	R	R	R
LW-9064	(32bit) : size of data sampling files on HMI memory	R	R	R
LW-10489	(16bit) : no. of data sampling files on SD card	R	R	R
LW-10490	(32bit) : size of data sampling files on SD card	R	R	R
LW-10492	(16bit) : no. of data sampling files on USB disk	R	R	R
LW-10493	(32bit) : size of data sampling files on USB disk	R	R	R



1. The shortest interval between two successful executions is 2 seconds.
2. The registers for deleting or updating data samplings do not work during simulation on PC.

22.3.9. Event Log

Address	Description	Read(R)/Write(W)/Control(C)		
		Local HMI	Macro	Remote HMI
LB-9021	reset current event log (OFF->ON)	W	C	C
LB-9022	delete the earliest event log file on HMI memory (set ON)	W	C	C
LB-9023	delete all event log files on HMI memory (set ON)	W	C	C
LB-9024	refresh event log information on HMI memory (set ON)	W	C	C
LB-9034	save event/data sampling to HMI, USB disk, SD card (set ON) <i>*Note 2</i>	W	C	C
LB-9042	acknowledge all alarm events (set ON)	W	C	C
LB-9043	unacknowledged events exist (when ON)	R	R	R
LB-11940	delete the earliest event log file on SD card (set ON)	W	C	C
LB-11941	delete all event log files on SD card (set ON)	W	C	C
LB-11942	refresh event log information on SD card (set ON)	W	C	C
LB-11943	delete the earliest event log file on USB disk (set ON)	W	C	C
LB-11944	delete all event log files on USB disk (set ON)	W	C	C
LB-11945	refresh event log information on USB disk (set ON)	W	C	C
LW-9060	(16bit) : no. of event log files on HMI memory	R	R	R
LW-9061	(32bit) : size of event log files on HMI memory	R	R	R
LW-9450	(16bit) : time tag of event log – second <i>*Note 1</i>	R/W	R/C	R/C
LW-9451	(16bit) : time tag of event log – minute <i>*Note 1</i>	R/W	R/C	R/C
LW-9452	(16bit) : time tag of event log – hour <i>*Note 1</i>	R/W	R/C	R/C
LW-9453	(16bit) : time tag of event log – day <i>*Note 1</i>	R/W	R/C	R/C
LW-9454	(16bit) : time tag of event log – month <i>*Note 1</i>	R/W	R/C	R/C
LW-9455	(16bit) : time tag of event log – year <i>*Note 1</i>	R/W	R/C	R/C
LW-10480	(16bit) : no. of event log files on SD card	R	R	R
LW-10481	(32bit) : size of event log files on SD card	R	R	R
LW-10483	(16bit) : no. of event log files on USB disk	R	R	R
LW-10484	(32bit) : size of event log files on USB disk	R	R	R
LW-11443	(16bit) : push notification alarm status (0 : none; 1 : green; 2 : yellow; 3 : red)	R	R	R

**Note**

1. If LW-9450 ~ LW-9455 are used to get Event Log time, please enable in [system parameters] » [General].
2. The shortest interval between two successful executions is 2 seconds.
3. The registers for deleting or updating event logs do not work during simulation on PC.



Click the icon to download the demo project that explains how to use the system registers LW-9450 to LW-9455 to be the time tag of event log. Please confirm your internet connection.

22.3.10. Station Number Variables

Address	Description	Read(R)/Write(W)/Control(C)		
		Local HMI	Macro	Remote HMI
LW-10000	(16bit) : var0 - station no variable (usage : var0#address)	R/W	R/C	R/C
LW-10001	(16bit) : var1 - station no variable (usage : var1#address)	R/W	R/C	R/C
LW-10002	(16bit) : var2 - station no variable (usage : var2#address)	R/W	R/C	R/C
LW-10003	(16bit) : var3 - station no variable (usage : var3#address)	R/W	R/C	R/C
LW-10004	(16bit) : var4 - station no variable (usage : var4#address)	R/W	R/C	R/C
LW-10005	(16bit) : var5 - station no variable (usage : var5#address)	R/W	R/C	R/C
LW-10006	(16bit) : var6 - station no variable (usage : var6#address)	R/W	R/C	R/C
LW-10007	(16bit) : var7 - station no variable (usage : var7#address)	R/W	R/C	R/C
LW-10008	(16bit) : var8 - station no variable (usage : var8#address)	R/W	R/C	R/C
LW-10009	(16bit) : var9 - station no variable (usage : var9#address)	R/W	R/C	R/C
LW-10010	(16bit) : var10 - station no variable (usage : var10#address)	R/W	R/C	R/C
LW-10011	(16bit) : var11 - station no variable (usage : var11#address)	R/W	R/C	R/C
LW-10012	(16bit) : var12 - station no variable (usage : var12#address)	R/W	R/C	R/C
LW-10013	(16bit) : var13 - station no variable (usage : var13#address)	R/W	R/C	R/C
LW-10014	(16bit) : var14 - station no variable (usage : var14#address)	R/W	R/C	R/C
LW-10015	(16bit) : var15 - station no variable (usage : var15#address)	R/W	R/C	R/C



Click the icon to download the demo project. Please confirm your internet connection.

22.3.11. Index Registers

Address	Description	Read(R)/Write(W)/Control(C)		
		Local HMI	Macro	Remote HMI
LW-9200	(16bit) : address index 0	R/W	R/C	R/C
LW-9201	(16bit) : address index 1	R/W	R/C	R/C
LW-9202	(16bit) : address index 2	R/W	R/C	R/C
LW-9203	(16bit) : address index 3	R/W	R/C	R/C
LW-9204	(16bit) : address index 4	R/W	R/C	R/C
LW-9205	(16bit) : address index 5	R/W	R/C	R/C
LW-9206	(16bit) : address index 6	R/W	R/C	R/C
LW-9207	(16bit) : address index 7	R/W	R/C	R/C
LW-9208	(16bit) : address index 8	R/W	R/C	R/C
LW-9209	(16bit) : address index 9	R/W	R/C	R/C
LW-9210	(16bit) : address index 10	R/W	R/C	R/C
LW-9211	(16bit) : address index 11	R/W	R/C	R/C
LW-9212	(16bit) : address index 12	R/W	R/C	R/C
LW-9213	(16bit) : address index 13	R/W	R/C	R/C
LW-9214	(16bit) : address index 14	R/W	R/C	R/C
LW-9215	(16bit) : address index 15	R/W	R/C	R/C
LW-9230	(32bit) : address index 16	R/W	R/C	R/C
LW-9232	(32bit) : address index 17	R/W	R/C	R/C
LW-9234	(32bit) : address index 18	R/W	R/C	R/C
LW-9236	(32bit) : address index 19	R/W	R/C	R/C
LW-9238	(32bit) : address index 20	R/W	R/C	R/C
LW-9240	(32bit) : address index 21	R/W	R/C	R/C
LW-9242	(32bit) : address index 22	R/W	R/C	R/C
LW-9244	(32bit) : address index 23	R/W	R/C	R/C
LW-9246	(32bit) : address index 24	R/W	R/C	R/C
LW-9248	(32bit) : address index 25	R/W	R/C	R/C
LW-9250	(32bit) : address index 26	R/W	R/C	R/C
LW-9252	(32bit) : address index 27	R/W	R/C	R/C
LW-9254	(32bit) : address index 28	R/W	R/C	R/C
LW-9256	(32bit) : address index 29	R/W	R/C	R/C
LW-9258	(32bit) : address index 30	R/W	R/C	R/C
LW-9260	(32bit) : address index 31	R/W	R/C	R/C



Click the icon to download the demo project. Please confirm your internet connection.

22.3.12. MODBUS Server Communication

Address	Description	Read(R)/Write(W)/Control(C)		
		Local HMI	Macro	Remote HMI
LB-9055	MODBUS server (COM 1) receives a request (when ON)	R	R	R
LB-9056	MODBUS server (COM 2) receives a request (when ON)	R	R	R
LB-9057	MODBUS server (COM 3) receives a request (when ON)	R	R	R
LB-9058	MODBUS server (ethernet) receives a request (when ON)	R	R	R
LB-12052	MODBUS server status (disabled when ON)	R/W	R/C	R/C
LW-9270	(16bit) : request's function code - MODBUS server (COM 1)	R	R	R
LW-9271	(16bit) : request's starting address - MODBUS server (COM 1)	R	R	R
LW-9272	(16bit) : request's quantity of registers - MODBUS server (COM 1)	R	R	R
LW-9275	(16bit) : request's function code - MODBUS server (COM 2)	R	R	R
LW-9276	(16bit) : request's starting address - MODBUS server (COM 2)	R	R	R
LW-9277	(16bit) : request's quantity of registers - MODBUS server (COM 2)	R	R	R
LW-9280	(16bit) : request's function code - MODBUS server (COM 3)	R	R	R
LW-9281	(16bit) : request's starting address - MODBUS server (COM 3)	R	R	R
LW-9282	(16bit) : request's quantity of registers - MODBUS server (COM 3)	R	R	R
LW-9285	(16bit) : request's function code - MODBUS server (ethernet)	R	R	R
LW-9286	(16bit) : request's starting address - MODBUS server (ethernet)	R	R	R
LW-9287	(16bit) : request's quantity of registers - MODBUS server (ethernet)	R	R	R
LW-9288	(16bit) : last error code - MODBUS server (ethernet)	R	R	R
LW-9541	(16bit) : MODBUS/ASCII server station no. (COM 1)	R/W	R/C	R/C
LW-9542	(16bit) : MODBUS/ASCII server station no. (COM 2)	R/W	R/C	R/C
LW-9543	(16bit) : MODBUS/ASCII server station no. (COM 3)	R/W	R/C	R/C
LW-9544	(16bit) : MODBUS/ASCII server station no. (ethernet)	R/W	R/C	R/C
LW-9570	(32bit) : received data count (bytes) (COM 1 MODBUS server)	R	R	R

LW-9572	(32bit) : received data count (bytes) (COM 2 MODBUS server)	R	R	R
LW-9574	(32bit) : received data count (bytes) (COM 3 MODBUS server)	R	R	R
LW-9576	(32bit) : received data count (bytes) (Ethernet MODBUS server)	R	R	R

22.3.13. Communication Parameter Settings

Address	Description	Read(R)/Write(W)/Control(C)		
		Local HMI	Macro	Remote HMI
LB-9030	update COM 1 communication parameters (set ON)	R/W	R/C	R/C
LB-9031	update COM 2 communication parameters (set ON)	R/W	R/C	R/C
LB-9032	update COM 3 communication parameters (set ON)	R/W	R/C	R/C
LB-9065	disable/enable COM 1 broadcast station no.	R/W	R/C	R/C
LB-9066	disable/enable COM 2 broadcast station no.	R/W	R/C	R/C
LB-9067	disable/enable COM 3 broadcast station no.	R/W	R/C	R/C
LW-9550	(16bit) : COM 1 mode(0:RS232,1:RS485 2W,2:RS485 4W)	R/W	R/C	R/C
LW-9551	(16bit) : COM 1 baud rate (7:1200,8:2400,0:4800,1:9600,10:14400, 2:19200,11:28800,3:38400,4:57600,..)	R/W	R/C	R/C
LW-9552	(16bit) : COM 1 databits (7 : 7 bits, 8 : 8 bits)	R/W	R/C	R/C
LW-9553	(16bit) : COM 1 parity (0:none, 1:even, 2:odd, 3:mark, 4:space)	R/W	R/C	R/C
LW-9554	(16bit) : COM 1 stop bits (1 : 1 bit, 2 : 2 bits)	R/W	R/C	R/C
LW-9555	(16bit) : COM 2 mode(0:RS232,1:RS485 2W,2:RS485 4W)	R/W	R/C	R/C
LW-9556	(16bit) : COM 2 baud rate (7:1200,8:2400,0:4800,1:9600,10:14400, 2:19200,11:28800,3:38400,4:57600,..)	R/W	R/C	R/C
LW-9557	(16bit) : COM 2 databits (7 : 7 bits, 8 : 8 bits)	R/W	R/C	R/C
LW-9558	(16bit) : COM 2 parity (0:none, 1:even, 2:odd, 3:mark, 4:space)	R/W	R/C	R/C
LW-9559	(16bit) : COM 2 stop bits (1 : 1 bit, 2 : 2 bits)	R/W	R/C	R/C
LW-9560	(16bit) : COM 3 mode(0:RS232,1:RS485 2W)	R/W	R/C	R/C
LW-9561	(16bit) : COM 3 baud rate (7:1200,8:2400,0:4800,1:9600,10:14400, 2:19200,11:28800,3:38400,4:57600,..)	R/W	R/C	R/C

LW-9562	(16bit) : COM 3 databits (7 : 7 bits, 8 : 8 bits)	R/W	R/C	R/C
LW-9563	(16bit) : COM 3 parity (0:none, 1:even, 2:odd, 3:mark, 4:space)	R/W	R/C	R/C
LW-9564	(16bit) : COM 3 stop bits (1 : 1 bit, 2 : 2 bits)	R/W	R/C	R/C
LW-9565	(16bit) : COM 1 broadcast station no.	R/W	R/C	R/C
LW-9566	(16bit) : COM 2 broadcast station no.	R/W	R/C	R/C
LW-9567	(16bit) : COM 3 broadcast station no.	R/W	R/C	R/C
LW-10500	(16bit) : PLC 1 timeout (unit : 100ms)	R/W	R/C	R/C
LW-10501	(16bit) : PLC 1 turn around delay (unit : ms)	R/W	R/C	R/C
LW-10502	(16bit) : PLC 1 send ACK delay (unit : ms)	R/W	R/C	R/C
LW-10503	(16bit) : PLC 1 parameter 1	R/W	R/C	R/C
LW-10504	(16bit) : PLC 1 parameter 2	R/W	R/C	R/C
LW-10505	(16bit) : PLC 2 timeout (unit : 100ms)	R/W	R/C	R/C
LW-10506	(16bit) : PLC 2 turn around delay (unit : ms)	R/W	R/C	R/C
LW-10507	(16bit) : PLC 2 send ACK delay (unit : ms)	R/W	R/C	R/C
LW-10508	(16bit) : PLC 2 parameter 1	R/W	R/C	R/C
LW-10509	(16bit) : PLC 2 parameter 2	R/W	R/C	R/C
LW-10510	(16bit) : PLC 3 timeout (unit : 100ms)	R/W	R/C	R/C
LW-10511	(16bit) : PLC 3 turn around delay (unit : ms)	R/W	R/C	R/C
LW-10512	(16bit) : PLC 3 send ACK delay (unit : ms)	R/W	R/C	R/C
LW-10513	(16bit) : PLC 3 parameter 1	R/W	R/C	R/C
LW-10514	(16bit) : PLC 3 parameter 2	R/W	R/C	R/C
LW-10515	(16bit) : PLC 4 timeout (unit : 100ms)	R/W	R/C	R/C
LW-10516	(16bit) : PLC 4 turn around delay (unit : ms)	R/W	R/C	R/C
LW-10517	(16bit) : PLC 4 send ACK delay (unit : ms) (SIEMENS S7/400 Link type)	R/W	R/C	R/C
LW-10518	(16bit) : PLC 4 parameter 1 (SIEMENS S7/400 rack)	R/W	R/C	R/C
LW-10519	(16bit) : PLC 4 parameter 2 (SIEMENS S7/400 CPU slot)	R/W	R/C	R/C
LW-10520	(16bit) : PLC 5 timeout (unit : 100ms)	R/W	R/C	R/C
LW-10521	(16bit) : PLC 5 turn around delay (unit : ms)	R/W	R/C	R/C
LW-10522	(16bit) : PLC 5 send ACK delay (unit : ms) (SIEMENS S7/400 Link type)	R/W	R/C	R/C
LW-10523	(16bit) : PLC 5 parameter 1 (SIEMENS S7/400 rack)	R/W	R/C	R/C
LW-10524	(16bit) : PLC 5 parameter 2 (SIEMENS S7/400 CPU slot)	R/W	R/C	R/C
LW-10525	(16bit) : PLC 6 timeout (unit : 100ms)	R/W	R/C	R/C
LW-10526	(16bit) : PLC 6 turn around delay (unit : ms)	R/W	R/C	R/C
LW-10527	(16bit) : PLC 6 send ACK delay (unit : ms) (SIEMENS S7/400	R/W	R/C	R/C

	Link type)			
LW-10528	(16bit) : PLC 6 parameter 1 (SIEMENS S7/400 rack)	R/W	R/C	R/C
LW-10529	(16bit) : PLC 6 parameter 2 (SIEMENS S7/400 CPU slot)	R/W	R/C	R/C
LW-10530	(16bit) : PLC 7 timeout (unit : 100ms)	R/W	R/C	R/C
LW-10531	(16bit) : PLC 7 turn around delay (unit : ms)	R/W	R/C	R/C
LW-10532	(16bit) : PLC 7 send ACK delay (unit : ms) (SIEMENS S7/400 Link type)	R/W	R/C	R/C
LW-10533	(16bit) : PLC 7 parameter 1 (SIEMENS S7/400 rack)	R/W	R/C	R/C
LW-10534	(16bit) : PLC 7 parameter 2 (SIEMENS S7/400 CPU slot)	R/W	R/C	R/C
LW-10535	(16bit) : PLC 8 timeout (unit : 100ms)	R/W	R/C	R/C
LW-10536	(16bit) : PLC 8 turn around delay (unit : ms)	R/W	R/C	R/C
LW-10537	(16bit) : PLC 8 send ACK delay (unit : ms) (SIEMENS S7/400 Link type)	R/W	R/C	R/C
LW-10538	(16bit) : PLC 8 parameter 1 (SIEMENS S7/400 rack)	R/W	R/C	R/C
LW-10539	(16bit) : PLC 8 parameter 2 (SIEMENS S7/400 CPU slot)	R/W	R/C	R/C
LW-10655	(16bit) : PLC 32 timeout (unit : 100ms)	R/W	R/C	R/C
LW-10656	(16bit) : PLC 32 turn around delay (unit : ms)	R/W	R/C	R/C
LW-10657	(16bit) : PLC 32 send ACK delay (unit : ms)	R/W	R/C	R/C
LW-10658	(16bit) : PLC 32 parameter 1	R/W	R/C	R/C
LW-10659	(16bit) : PLC 32 parameter 2	R/W	R/C	R/C

22.3.14. Communication Status and Control with PLC (COM)

Address	Description	Read(R)/Write(W)/Control(C)		
		Local HMI	Macro	Remote HMI
LB-9150	auto. connection for PLC 1 (COM 1) (when ON)	R/W	R/C	R/C
LB-9151	auto. connection for PLC 2 (COM 2) (when ON)	R/W	R/C	R/C
LB-9152	auto. connection for PLC 3 (COM 3) (when ON)	R/W	R/C	R/C
LB-9200	PLC 1 status (SN0, COM 1), set on to retry connection.	R/W	R/C	R/C
LB-9201	PLC 1 status (SN1, COM 1), set on to retry connection	R/W	R/C	R/C
LB-9202	PLC 1 status (SN2, COM 1), set on to retry connection	R/W	R/C	R/C
LB-9203	PLC 1 status (SN3, COM 1), set on to retry connection	R/W	R/C	R/C
LB-9204	PLC 1 status (SN4, COM 1), set on to retry connection	R/W	R/C	R/C
LB-9205	PLC 1 status (SN5, COM 1), set on to retry connection	R/W	R/C	R/C
LB-9206	PLC 1 status (SN6, COM 1), set on to retry connection	R/W	R/C	R/C
LB-9207	PLC 1 status (SN7, COM 1), set on to retry connection	R/W	R/C	R/C
LB-9455	PLC 1 status (SN255, COM 1), set on to retry connection	R/W	R/C	R/C
LB-9500	PLC 2 status (SN0, COM 2), set on to retry connection.	R/W	R/C	R/C
LB-9501	PLC 2 status (SN1, COM 2), set on to retry connection	R/W	R/C	R/C
LB-9502	PLC 2 status (SN2, COM 2), set on to retry connection	R/W	R/C	R/C
LB-9503	PLC 2 status (SN3, COM 2), set on to retry connection	R/W	R/C	R/C
LB-9504	PLC 2 status (SN4, COM 2), set on to retry connection	R/W	R/C	R/C
LB-9505	PLC 2 status (SN5, COM 2), set on to retry connection	R/W	R/C	R/C
LB-9506	PLC 2 status (SN6, COM 2), set on to retry connection	R/W	R/C	R/C
LB-9507	PLC 2 status (SN7, COM 2), set on to retry connection	R/W	R/C	R/C
LB-9755	PLC 2 status (SN255, COM 2), set on to retry connection	R/W	R/C	R/C
LB-9800	PLC 3 status (SN0, COM 3), set on to retry connection	R/W	R/C	R/C
LB-9801	PLC 3 status (SN1, COM 3), set on to retry connection	R/W	R/C	R/C
LB-9802	PLC 3 status (SN2, COM 3), set on to retry connection	R/W	R/C	R/C
LB-9803	PLC 3 status (SN3, COM 3), set on to retry connection	R/W	R/C	R/C
LB-9804	PLC 3 status (SN4, COM 3), set on to retry connection	R/W	R/C	R/C
LB-9805	PLC 3 status (SN5, COM 3), set on to retry connection	R/W	R/C	R/C
LB-9806	PLC 3 status (SN6, COM 3), set on to retry connection	R/W	R/C	R/C
LB-9807	PLC 3 status (SN7, COM 3), set on to retry connection	R/W	R/C	R/C
LB-10055	PLC 3 status (SN255, COM 3), set on to retry connection	R/W	R/C	R/C
LB-12030	COM 1 status (OFF : normal, ON : open failed) *Note 1	R	R	R
LB-12031	COM 2 status (OFF : normal, ON : open failed)	R	R	R
LB-12032	COM 3 status (OFF : normal, ON : open failed)	R	R	R

LB-12033	COM 4 status (OFF : normal, ON : open failed)	R	R	R
LB-12034	COM 5 status (OFF : normal, ON : open failed)	R	R	R
LB-12035	COM 6 status (OFF : normal, ON : open failed)	R	R	R
LB-12036	COM 7 status (OFF : normal, ON : open failed)	R	R	R
LB-12037	COM 8 status (OFF : normal, ON : open failed)	R	R	R
LB-12038	COM 9 status (OFF : normal, ON : open failed)	R	R	R
LW-9351	(16bit) : pending command no. in PLC 1 (COM 1)	R	R	R
LW-9352	(16bit) : pending command no. in PLC 2 (COM 2)	R	R	R
LW-9353	(16bit) : pending command no. in PLC 3 (COM 3)	R	R	R

 **Note**

1. The ON state of COM is for checking if COM is occupied by other program during simulation on PC.

22.3.15. Communication Status and Control with PLC (Ethernet)

Address	Description	Read(R)/Write(W)/Control(C)		
		Local HMI	Macro	Remote HMI
LB-9153	auto. connection for PLC 4 (ethernet) (when ON)	R/W	R/C	R/C
LB-9154	auto. connection for PLC 5 (ethernet) (when ON)	R/W	R/C	R/C
LB-9155	auto. connection for PLC 6 (ethernet) (when ON)	R/W	R/C	R/C
LB-9156	auto. connection for PLC 7 (ethernet) (when ON)	R/W	R/C	R/C
LB-9157	auto. connection for PLC 8 (ethernet) (when ON)	R/W	R/C	R/C
LB-9158	auto. connection for PLC 9 (ethernet) (when ON)	R/W	R/C	R/C
LB-9189	auto. connection for PLC 40 (ethernet) (when ON)	R/W	R/C	R/C
LB-10070	forced to reconnect PLC 4 (ethernet) when IP or system parameters changed on-line (set ON)	R/W	R/C	R/C
LB-10071	forced to reconnect PLC 5 (ethernet) when IP or system parameters changed on-line (set ON)	R/W	R/C	R/C
LB-10072	forced to reconnect PLC 6 (ethernet) when IP or system parameters changed on-line (set ON)	R/W	R/C	R/C
LB-10073	forced to reconnect PLC 7 (ethernet) when IP or system parameters changed on-line (set ON)	R/W	R/C	R/C
LB-10074	forced to reconnect PLC 8 (ethernet) when IP or system parameters changed on-line (set ON)	R/W	R/C	R/C
LB-10075	forced to reconnect PLC 9 (ethernet) when IP or system parameters changed on-line (set ON)	R/W	R/C	R/C
LB-10099	forced to reconnect PLC 33 (ethernet) when IP or system	R/W	R/C	R/C

	parameters changed on-line (set ON)			
LB-10100	PLC 4 status (ethernet), set on to retry connection	R/W	R/C	R/C
LB-10400	PLC 5 status (ethernet), set on to retry connection	R/W	R/C	R/C
LB-10700	PLC 6 status (ethernet), set on to retry connection	R/W	R/C	R/C
LB-11000	PLC 7 status (ethernet), set on to retry connection	R/W	R/C	R/C
LB-11300	PLC 8 status (ethernet), set on to retry connection	R/W	R/C	R/C
LB-11600	PLC 9 status (ethernet), set on to retry connection	R/W	R/C	R/C
LB-11900	PLC 10 status (ethernet), set on to retry connection	R/W	R/C	R/C
LB-11901	PLC 11 status (ethernet), set on to retry connection	R/W	R/C	R/C
LB-11902	PLC 12 status (ethernet), set on to retry connection	R/W	R/C	R/C
LB-11903	PLC 13 status (ethernet), set on to retry connection	R/W	R/C	R/C
LB-11904	PLC 14 status (ethernet), set on to retry connection	R/W	R/C	R/C
LB-11905	PLC 15 status (ethernet), set on to retry connection	R/W	R/C	R/C
LB-11906	PLC 16 status (ethernet), set on to retry connection	R/W	R/C	R/C
LB-11939	PLC 49 status (ethernet), set on to retry connection	R/W	R/C	R/C
LW-9354	(16bit) : pending command no. in PLC 4 (ethernet)	R	R	R
LW-9355	(16bit) : pending command no. in PLC 5 (ethernet)	R	R	R
LW-9356	(16bit) : pending command no. in PLC 6 (ethernet)	R	R	R
LW-9357	(16bit) : pending command no. in PLC 7 (ethernet)	R	R	R
LW-9389	(16bit) : pending command no. in PLC 39 (ethernet)	R	R	R
LW-9600	(16bit) : PLC 4's IP0 (IP address = IP0:IP1:IP2:IP3)	R/W	R/C	R/C
LW-9601	(16bit) : PLC 4's IP1 (IP address = IP0:IP1:IP2:IP3)	R/W	R/C	R/C
LW-9602	(16bit) : PLC 4's IP2 (IP address = IP0:IP1:IP2:IP3)	R/W	R/C	R/C
LW-9603	(16bit) : PLC 4's IP3 (IP address = IP0:IP1:IP2:IP3)	R/W	R/C	R/C
LW-9604	(16bit) : PLC 4's port no.	R/W	R/C	R/C
LW-9605	(16bit) : PLC 5's IP0 (IP address = IP0:IP1:IP2:IP3)	R/W	R/C	R/C
LW-9606	(16bit) : PLC 5's IP1 (IP address = IP0:IP1:IP2:IP3)	R/W	R/C	R/C
LW-9607	(16bit) : PLC 5's IP2 (IP address = IP0:IP1:IP2:IP3)	R/W	R/C	R/C
LW-9608	(16bit) : PLC 5's IP3 (IP address = IP0:IP1:IP2:IP3)	R/W	R/C	R/C
LW-9609	(16bit) : PLC 5's port no.	R/W	R/C	R/C
LW-9610	(16bit) : PLC 6's IP0 (IP address = IP0:IP1:IP2:IP3)	R/W	R/C	R/C
LW-9611	(16bit) : PLC 6's IP1 (IP address = IP0:IP1:IP2:IP3)	R/W	R/C	R/C
LW-9612	(16bit) : PLC 6's IP2 (IP address = IP0:IP1:IP2:IP3)	R/W	R/C	R/C
LW-9613	(16bit) : PLC 6's IP3 (IP address = IP0:IP1:IP2:IP3)	R/W	R/C	R/C
LW-9614	(16bit) : PLC 6's port no.	R/W	R/C	R/C

LW-9615	(16bit) : PLC 7's IP0 (IP address = IP0:IP1:IP2:IP3)	R/W	R/C	R/C
LW-9616	(16bit) : PLC 7's IP1 (IP address = IP0:IP1:IP2:IP3)	R/W	R/C	R/C
LW-9617	(16bit) : PLC 7's IP2 (IP address = IP0:IP1:IP2:IP3)	R/W	R/C	R/C
LW-9618	(16bit) : PLC 7's IP3 (IP address = IP0:IP1:IP2:IP3)	R/W	R/C	R/C
LW-9619	(16bit) : PLC 7's port no.	R/W	R/C	R/C
LW-9620	(16bit) : PLC 8's IP0 (IP address = IP0:IP1:IP2:IP3)	R/W	R/C	R/C
LW-9621	(16bit) : PLC 8's IP1 (IP address = IP0:IP1:IP2:IP3)	R/W	R/C	R/C
LW-9622	(16bit) : PLC 8's IP2 (IP address = IP0:IP1:IP2:IP3)	R/W	R/C	R/C
LW-9623	(16bit) : PLC 8's IP3 (IP address = IP0:IP1:IP2:IP3)	R/W	R/C	R/C
LW-9624	(16bit) : PLC 8's port no.	R/W	R/C	R/C
LW-9625	(16bit) : PLC 9's IP0 (IP address = IP0:IP1:IP2:IP3)	R/W	R/C	R/C
LW-9626	(16bit) : PLC 9's IP1 (IP address = IP0:IP1:IP2:IP3)	R/W	R/C	R/C
LW-9627	(16bit) : PLC 9's IP2 (IP address = IP0:IP1:IP2:IP3)	R/W	R/C	R/C
LW-9628	(16bit) : PLC 9's IP3 (IP address = IP0:IP1:IP2:IP3)	R/W	R/C	R/C
LW-9629	(16bit) : PLC 9's port no.	R/W	R/C	R/C
LW-9765	(16bit) : PLC 37's IP0 (IP address = IP0:IP1:IP2:IP3)	R/W	R/C	R/C
LW-9766	(16bit) : PLC 37's IP1 (IP address = IP0:IP1:IP2:IP3)	R/W	R/C	R/C
LW-9767	(16bit) : PLC 37's IP2 (IP address = IP0:IP1:IP2:IP3)	R/W	R/C	R/C
LW-9768	(16bit) : PLC 37's IP3 (IP address = IP0:IP1:IP2:IP3)	R/W	R/C	R/C
LW-9769	(16bit) : PLC 37's port no.	R/W	R/C	R/C

22.3.16. Communication Status and Control with PLC (USB)

Address	Description	Read(R)/Write(W)/Control(C)		
		Local HMI	Macro	Remote HMI
LB-9190	auto. connection for PLC (USB) (when ON)	R/W	R/C	R/C
LB-9191	PLC status (USB), set on to retry connection	R/W	R/C	R/C
LW-9390	(16bit) : pending command no. in PLC (USB)	R	R	R

22.3.17. Communication Status and Control with PLC (CAN Bus)

Address	Description	Read(R)/Write(W)/Control(C)		
		Local HMI	Macro	Remote HMI
LB-12080	auto. connection for PLC (CAN Bus) (when ON)	R/W	R/C	R/C
LB-12081	PLC status (CAN Bus) set on to retry connection	R/W	R/C	R/C
LB-12100	pause CAN Bus device 1 communication (when ON)	R/W	R/C	R/C
LB-12101	pause CAN Bus device 2 communication (when ON)	R/W	R/C	R/C
LB-12102	pause CAN Bus device 3 communication (when ON)	R/W	R/C	R/C
LB-12103	pause CAN Bus device 4 communication (when ON)	R/W	R/C	R/C
LB-12104	pause CAN Bus device 5 communication (when ON)	R/W	R/C	R/C
LB-12105	pause CAN Bus device 6 communication (when ON)	R/W	R/C	R/C
LB-12106	pause CAN Bus device 7 communication (when ON)	R/W	R/C	R/C
LB-12107	pause CAN Bus device 8 communication (when ON)	R/W	R/C	R/C
LB-12108	pause CAN Bus device 9 communication (when ON)	R/W	R/C	R/C
LB-12109	pause CAN Bus device 10 communication (when ON)	R/W	R/C	R/C
LB-12354	pause CAN Bus device 255 communication (when ON)	R/W	R/C	R/C
LW-9392	(16bit) : pending command no. in PLC (CAN Bus)	R	R	R

22.3.18. Communication Status and Control with Remote HMI

Address	Description	Read(R)/Write(W)/Control(C)		
		Local HMI	Macro	Remote HMI
LB-9068	auto. connection for remote HMI 1 (when ON)	R/W	R/C	R/C
LB-9069	auto. connection for remote HMI 2 (when ON)	R/W	R/C	R/C
LB-9070	auto. connection for remote HMI 3 (when ON)	R/W	R/C	R/C
LB-9071	auto. connection for remote HMI 4 (when ON)	R/W	R/C	R/C
LB-9072	auto. connection for remote HMI 5 (when ON)	R/W	R/C	R/C
LB-9073	auto. connection for remote HMI 6 (when ON)	R/W	R/C	R/C
LB-9074	auto. connection for remote HMI 7 (when ON)	R/W	R/C	R/C
LB-9075	auto. connection for remote HMI 8 (when ON)	R/W	R/C	R/C
LB-9099	auto. connection for remote HMI 32 (when ON)	R/W	R/C	R/C
LB-9100	remote HMI 1 status (set on to retry connection)	R/W	R/C	R/C
LB-9101	remote HMI 2 status (set on to retry connection)	R/W	R/C	R/C
LB-9102	remote HMI 3 status (set on to retry connection)	R/W	R/C	R/C
LB-9103	remote HMI 4 status (set on to retry connection)	R/W	R/C	R/C
LB-9104	remote HMI 5 status (set on to retry connection)	R/W	R/C	R/C

LB-9105	remote HMI 6 status (set on to retry connection)	R/W	R/C	R/C
LB-9106	remote HMI 7 status (set on to retry connection)	R/W	R/C	R/C
LB-9107	remote HMI 8 status (set on to retry connection)	R/W	R/C	R/C
LB-9148	remote HMI 49 status (set on to retry connection)	R/W	R/C	R/C
LB-9149	forced to reconnect remote HMI when IP changed on-line (set ON)	R/W	R/C	R/C
LW-9800	(16bit) : remote HMI 1's IP0 (IP address = IP0:IP1:IP2:IP3)	R/W	R/C	R/C
LW-9801	(16bit) : remote HMI 1's IP1 (IP address = IP0:IP1:IP2:IP3)	R/W	R/C	R/C
LW-9802	(16bit) : remote HMI 1's IP2 (IP address = IP0:IP1:IP2:IP3)	R/W	R/C	R/C
LW-9803	(16bit) : remote HMI 1's IP3 (IP address = IP0:IP1:IP2:IP3)	R/W	R/C	R/C
LW-9804	(16bit) : remote HMI 1's port no.	R/W	R/C	R/C
LW-9805	(16bit) : remote HMI 2's IP0 (IP address = IP0:IP1:IP2:IP3)	R/W	R/C	R/C
LW-9806	(16bit) : remote HMI 2's IP1 (IP address = IP0:IP1:IP2:IP3)	R/W	R/C	R/C
LW-9807	(16bit) : remote HMI 2's IP2 (IP address = IP0:IP1:IP2:IP3)	R/W	R/C	R/C
LW-9808	(16bit) : remote HMI 2's IP3 (IP address = IP0:IP1:IP2:IP3)	R/W	R/C	R/C
LW-9809	(16bit) : remote HMI 2's port no.	R/W	R/C	R/C
LW-9810	(16bit) : remote HMI 3's IP0 (IP address = IP0:IP1:IP2:IP3)	R/W	R/C	R/C
LW-9811	(16bit) : remote HMI 3's IP1 (IP address = IP0:IP1:IP2:IP3)	R/W	R/C	R/C
LW-9812	(16bit) : remote HMI 3's IP2 (IP address = IP0:IP1:IP2:IP3)	R/W	R/C	R/C
LW-9813	(16bit) : remote HMI 3's IP3 (IP address = IP0:IP1:IP2:IP3)	R/W	R/C	R/C
LW-9814	(16bit) : remote HMI 3's port no.	R/W	R/C	R/C
LW-9815	(16bit) : remote HMI 4's IP0 (IP address = IP0:IP1:IP2:IP3)	R/W	R/C	R/C
LW-9816	(16bit) : remote HMI 4's IP1 (IP address = IP0:IP1:IP2:IP3)	R/W	R/C	R/C
LW-9817	(16bit) : remote HMI 4's IP2 (IP address = IP0:IP1:IP2:IP3)	R/W	R/C	R/C
LW-9818	(16bit) : remote HMI 4's IP3 (IP address = IP0:IP1:IP2:IP3)	R/W	R/C	R/C
LW-9819	(16bit) : remote HMI 4's port no.	R/W	R/C	R/C
LW-9820	(16bit) : remote HMI 5's IP0 (IP address = IP0:IP1:IP2:IP3)	R/W	R/C	R/C
LW-9821	(16bit) : remote HMI 5's IP1 (IP address = IP0:IP1:IP2:IP3)	R/W	R/C	R/C
LW-9822	(16bit) : remote HMI 5's IP2 (IP address = IP0:IP1:IP2:IP3)	R/W	R/C	R/C
LW-9823	(16bit) : remote HMI 5's IP3 (IP address = IP0:IP1:IP2:IP3)	R/W	R/C	R/C
LW-9824	(16bit) : remote HMI 5's port no.	R/W	R/C	R/C
LW-9825	(16bit) : remote HMI 6's IP0 (IP address = IP0:IP1:IP2:IP3)	R/W	R/C	R/C
LW-9826	(16bit) : remote HMI 6's IP1 (IP address = IP0:IP1:IP2:IP3)	R/W	R/C	R/C
LW-9827	(16bit) : remote HMI 6's IP2 (IP address = IP0:IP1:IP2:IP3)	R/W	R/C	R/C
LW-9828	(16bit) : remote HMI 6's IP3 (IP address = IP0:IP1:IP2:IP3)	R/W	R/C	R/C
LW-9829	(16bit) : remote HMI 6's port no.	R/W	R/C	R/C
LW-9830	(16bit) : remote HMI 7's IP0 (IP address = IP0:IP1:IP2:IP3)	R/W	R/C	R/C

LW-9831	(16bit) : remote HMI 7's IP1 (IP address = IP0:IP1:IP2:IP3)	R/W	R/C	R/C
LW-9832	(16bit) : remote HMI 7's IP2 (IP address = IP0:IP1:IP2:IP3)	R/W	R/C	R/C
LW-9833	(16bit) : remote HMI 7's IP3 (IP address = IP0:IP1:IP2:IP3)	R/W	R/C	R/C
LW-9834	(16bit) : remote HMI 7's port no.	R/W	R/C	R/C
LW-9835	(16bit) : remote HMI 8's IP0 (IP address = IP0:IP1:IP2:IP3)	R/W	R/C	R/C
LW-9836	(16bit) : remote HMI 8's IP1 (IP address = IP0:IP1:IP2:IP3)	R/W	R/C	R/C
LW-9837	(16bit) : remote HMI 8's IP2 (IP address = IP0:IP1:IP2:IP3)	R/W	R/C	R/C
LW-9838	(16bit) : remote HMI 8's IP3 (IP address = IP0:IP1:IP2:IP3)	R/W	R/C	R/C
LW-9839	(16bit) : remote HMI 8's port no.	R/W	R/C	R/C
LW-9895	(16bit) : remote HMI 20's IP0 (IP address = IP0:IP1:IP2:IP3)	R/W	R/C	R/C
LW-9896	(16bit) : remote HMI 20's IP1 (IP address = IP0:IP1:IP2:IP3)	R/W	R/C	R/C
LW-9897	(16bit) : remote HMI 20's IP2 (IP address = IP0:IP1:IP2:IP3)	R/W	R/C	R/C
LW-9898	(16bit) : remote HMI 20's IP3 (IP address = IP0:IP1:IP2:IP3)	R/W	R/C	R/C
LW-9899	(16bit) : remote HMI 20's port no.	R/W	R/C	R/C
LW-9905	(16bit) : remote HMI 21's IP0 (IP address = IP0:IP1:IP2:IP3)	R/W	R/C	R/C
LW-9906	(16bit) : remote HMI 21's IP1 (IP address = IP0:IP1:IP2:IP3)	R/W	R/C	R/C
LW-9907	(16bit) : remote HMI 21's IP2 (IP address = IP0:IP1:IP2:IP3)	R/W	R/C	R/C
LW-9908	(16bit) : remote HMI 21's IP3 (IP address = IP0:IP1:IP2:IP3)	R/W	R/C	R/C
LW-9909	(16bit) : remote HMI 21's port no.	R/W	R/C	R/C
LW-9910	(16bit) : remote HMI 22's IP0 (IP address = IP0:IP1:IP2:IP3)	R/W	R/C	R/C
LW-9911	(16bit) : remote HMI 22's IP1 (IP address = IP0:IP1:IP2:IP3)	R/W	R/C	R/C
LW-9912	(16bit) : remote HMI 22's IP2 (IP address = IP0:IP1:IP2:IP3)	R/W	R/C	R/C
LW-9913	(16bit) : remote HMI 22's IP3 (IP address = IP0:IP1:IP2:IP3)	R/W	R/C	R/C
LW-9914	(16bit) : remote HMI 22's port no.	R/W	R/C	R/C
LW-9915	(16bit) : remote HMI 23's IP0 (IP address = IP0:IP1:IP2:IP3)	R/W	R/C	R/C
LW-9916	(16bit) : remote HMI 23's IP1 (IP address = IP0:IP1:IP2:IP3)	R/W	R/C	R/C
LW-9917	(16bit) : remote HMI 23's IP2 (IP address = IP0:IP1:IP2:IP3)	R/W	R/C	R/C
LW-9918	(16bit) : remote HMI 23's IP3 (IP address = IP0:IP1:IP2:IP3)	R/W	R/C	R/C
LW-9919	(16bit) : remote HMI 23's port no.	R/W	R/C	R/C
LW-9920	(16bit) : remote HMI 24's IP0 (IP address = IP0:IP1:IP2:IP3)	R/W	R/C	R/C
LW-9921	(16bit) : remote HMI 24's IP1 (IP address = IP0:IP1:IP2:IP3)	R/W	R/C	R/C
LW-9922	(16bit) : remote HMI 24's IP2 (IP address = IP0:IP1:IP2:IP3)	R/W	R/C	R/C
LW-9923	(16bit) : remote HMI 24's IP3 (IP address = IP0:IP1:IP2:IP3)	R/W	R/C	R/C
LW-9924	(16bit) : remote HMI 24's port no.	R/W	R/C	R/C
LW-9925	(16bit) : remote HMI 25's IP0 (IP address = IP0:IP1:IP2:IP3)	R/W	R/C	R/C
LW-9926	(16bit) : remote HMI 25's IP1 (IP address = IP0:IP1:IP2:IP3)	R/W	R/C	R/C
LW-9927	(16bit) : remote HMI 25's IP2 (IP address = IP0:IP1:IP2:IP3)	R/W	R/C	R/C

LW-9928	(16bit) : remote HMI 25's IP3 (IP address = IP0:IP1:IP2:IP3)	R/W	R/C	R/C
LW-9929	(16bit) : remote HMI 25's port no.	R/W	R/C	R/C
LW-9930	(16bit) : remote HMI 26's IP0 (IP address = IP0:IP1:IP2:IP3)	R/W	R/C	R/C
LW-9931	(16bit) : remote HMI 26's IP1 (IP address = IP0:IP1:IP2:IP3)	R/W	R/C	R/C
LW-9932	(16bit) : remote HMI 26's IP2 (IP address = IP0:IP1:IP2:IP3)	R/W	R/C	R/C
LW-9933	(16bit) : remote HMI 26's IP3 (IP address = IP0:IP1:IP2:IP3)	R/W	R/C	R/C
LW-9934	(16bit) : remote HMI 26's port no.	R/W	R/C	R/C
LW-9935	(16bit) : remote HMI 27's IP0 (IP address = IP0:IP1:IP2:IP3)	R/W	R/C	R/C
LW-9936	(16bit) : remote HMI 27's IP1 (IP address = IP0:IP1:IP2:IP3)	R/W	R/C	R/C
LW-9937	(16bit) : remote HMI 27's IP2 (IP address = IP0:IP1:IP2:IP3)	R/W	R/C	R/C
LW-9938	(16bit) : remote HMI 27's IP3 (IP address = IP0:IP1:IP2:IP3)	R/W	R/C	R/C
LW-9939	(16bit) : remote HMI 27's port no.	R/W	R/C	R/C
LW-9940	(16bit) : remote HMI 28's IP0 (IP address = IP0:IP1:IP2:IP3)	R/W	R/C	R/C
LW-9941	(16bit) : remote HMI 28's IP1 (IP address = IP0:IP1:IP2:IP3)	R/W	R/C	R/C
LW-9942	(16bit) : remote HMI 28's IP2 (IP address = IP0:IP1:IP2:IP3)	R/W	R/C	R/C
LW-9943	(16bit) : remote HMI 28's IP3 (IP address = IP0:IP1:IP2:IP3)	R/W	R/C	R/C
LW-9944	(16bit) : remote HMI 28's port no.	R/W	R/C	R/C
LW-9945	(16bit) : remote HMI 29's IP0 (IP address = IP0:IP1:IP2:IP3)	R/W	R/C	R/C
LW-9946	(16bit) : remote HMI 29's IP1 (IP address = IP0:IP1:IP2:IP3)	R/W	R/C	R/C
LW-9947	(16bit) : remote HMI 29's IP2 (IP address = IP0:IP1:IP2:IP3)	R/W	R/C	R/C
LW-9948	(16bit) : remote HMI 29's IP3 (IP address = IP0:IP1:IP2:IP3)	R/W	R/C	R/C
LW-9949	(16bit) : remote HMI 29's port no.	R/W	R/C	R/C
LW-9950	(16bit) : remote HMI 30's IP0 (IP address = IP0:IP1:IP2:IP3)	R/W	R/C	R/C
LW-9951	(16bit) : remote HMI 30's IP1 (IP address = IP0:IP1:IP2:IP3)	R/W	R/C	R/C
LW-9952	(16bit) : remote HMI 30's IP2 (IP address = IP0:IP1:IP2:IP3)	R/W	R/C	R/C
LW-9953	(16bit) : remote HMI 30's IP3 (IP address = IP0:IP1:IP2:IP3)	R/W	R/C	R/C
LW-9954	(16bit) : remote HMI 30's port no.	R/W	R/C	R/C
LW-9955	(16bit) : remote HMI 31's IP0 (IP address = IP0:IP1:IP2:IP3)	R/W	R/C	R/C
LW-9956	(16bit) : remote HMI 31's IP1 (IP address = IP0:IP1:IP2:IP3)	R/W	R/C	R/C
LW-9957	(16bit) : remote HMI 31's IP2 (IP address = IP0:IP1:IP2:IP3)	R/W	R/C	R/C
LW-9958	(16bit) : remote HMI 31's IP3 (IP address = IP0:IP1:IP2:IP3)	R/W	R/C	R/C
LW-9959	(16bit) : remote HMI 31's port no.	R/W	R/C	R/C
LW-9960	(16bit) : remote HMI 32's IP0 (IP address = IP0:IP1:IP2:IP3)	R/W	R/C	R/C
LW-9961	(16bit) : remote HMI 32's IP1 (IP address = IP0:IP1:IP2:IP3)	R/W	R/C	R/C
LW-9962	(16bit) : remote HMI 32's IP2 (IP address = IP0:IP1:IP2:IP3)	R/W	R/C	R/C
LW-9963	(16bit) : remote HMI 32's IP3 (IP address = IP0:IP1:IP2:IP3)	R/W	R/C	R/C
LW-9964	(16bit) : remote HMI 32's port no.	R/W	R/C	R/C

LW-9995	(16bit) : remote HMI 39's IP0 (IP address = IP0:IP1:IP2:IP3)	R/W	R/C	R/C
LW-9996	(16bit) : remote HMI 39's IP1 (IP address = IP0:IP1:IP2:IP3)	R/W	R/C	R/C
LW-9997	(16bit) : remote HMI 39's IP2 (IP address = IP0:IP1:IP2:IP3)	R/W	R/C	R/C
LW-9998	(16bit) : remote HMI 39's IP3 (IP address = IP0:IP1:IP2:IP3)	R/W	R/C	R/C
LW-9999	(16bit) : remote HMI 39's port no.	R/W	R/C	R/C

22.3.19. Communication Status and Control with Remote PLC

Address	Description	Read(R)/Write(W)/Control(C)		
		Local HMI	Macro	Remote HMI
LW-10050	(16bit) : IP0 of the HMI connecting to remote PLC 1 (IP address = IP0:IP1:IP2:IP3)	R/W	R/C	R/C
LW-10051	(16bit) : IP1 of the HMI connecting to remote PLC 1 (IP address = IP0:IP1:IP2:IP3)	R/W	R/C	R/C
LW-10052	(16bit) : IP2 of the HMI connecting to remote PLC 1 (IP address = IP0:IP1:IP2:IP3)	R/W	R/C	R/C
LW-10053	(16bit) : IP3 of the HMI connecting to remote PLC 1 (IP address = IP0:IP1:IP2:IP3)	R/W	R/C	R/C
LW-10054	(16bit) : port no. of the HMI connecting to remote PLC 1	R/W	R/C	R/C
LW-10055	(16bit) : IP0 of the HMI connecting to remote PLC 2 (IP address = IP0:IP1:IP2:IP3)	R/W	R/C	R/C
LW-10056	(16bit) : IP1 of the HMI connecting to remote PLC 2 (IP address = IP0:IP1:IP2:IP3)	R/W	R/C	R/C
LW-10057	(16bit) : IP2 of the HMI connecting to remote PLC 2 (IP address = IP0:IP1:IP2:IP3)	R/W	R/C	R/C
LW-10058	(16bit) : IP3 of the HMI connecting to remote PLC 2 (IP address = IP0:IP1:IP2:IP3)	R/W	R/C	R/C
LW-10059	(16bit) : port no. of the HMI connecting to remote PLC 2	R/W	R/C	R/C
LW-10060	(16bit) : IP0 of the HMI connecting to remote PLC 3 (IP address = IP0:IP1:IP2:IP3)	R/W	R/C	R/C
LW-10061	(16bit) : IP1 of the HMI connecting to remote PLC 3 (IP address = IP0:IP1:IP2:IP3)	R/W	R/C	R/C
LW-10062	(16bit) : IP2 of the HMI connecting to remote PLC 3 (IP address = IP0:IP1:IP2:IP3)	R/W	R/C	R/C
LW-10063	(16bit) : IP3 of the HMI connecting to remote PLC 3 (IP address = IP0:IP1:IP2:IP3)	R/W	R/C	R/C
LW-10064	(16bit) : port no. of the HMI connecting to remote PLC 3	R/W	R/C	R/C

LW-10065	(16bit) : IP0 of the HMI connecting to remote PLC 4 (IP address = IP0:IP1:IP2:IP3)	R/W	R/C	R/C
LW-10066	(16bit) : IP1 of the HMI connecting to remote PLC 4 (IP address = IP0:IP1:IP2:IP3)	R/W	R/C	R/C
LW-10067	(16bit) : IP2 of the HMI connecting to remote PLC 4 (IP address = IP0:IP1:IP2:IP3)	R/W	R/C	R/C
LW-10068	(16bit) : IP3 of the HMI connecting to remote PLC 4 (IP address = IP0:IP1:IP2:IP3)	R/W	R/C	R/C
LW-10069	(16bit) : port no. of the HMI connecting to remote PLC 4	R/W	R/C	R/C
LW-10205	(16bit) : IP0 of the HMI connecting to remote PLC 32 (IP address = IP0:IP1:IP2:IP3)	R/W	R/C	R/C
LW-10206	(16bit) : IP1 of the HMI connecting to remote PLC 32 (IP address = IP0:IP1:IP2:IP3)	R/W	R/C	R/C
LW-10207	(16bit) : IP2 of the HMI connecting to remote PLC 32 (IP address = IP0:IP1:IP2:IP3)	R/W	R/C	R/C
LW-10208	(16bit) : IP3 of the HMI connecting to remote PLC 32 (IP address = IP0:IP1:IP2:IP3)	R/W	R/C	R/C
LW-10209	(16bit) : port no. of the HMI connecting to remote PLC 32	R/W	R/C	R/C
LW-10300	(16bit) : remote PLC 1's IP0 (IP address = IP0:IP1:IP2:IP3)	R/W	R/C	R/C
LW-10301	(16bit) : remote PLC 1's IP1 (IP address = IP0:IP1:IP2:IP3)	R/W	R/C	R/C
LW-10302	(16bit) : remote PLC 1's IP2 (IP address = IP0:IP1:IP2:IP3)	R/W	R/C	R/C
LW-10303	(16bit) : remote PLC 1's IP3 (IP address = IP0:IP1:IP2:IP3)	R/W	R/C	R/C
LW-10304	(16bit) : remote PLC 1's port no.	R/W	R/C	R/C
LW-10305	(16bit) : remote PLC 2's IP0 (IP address = IP0:IP1:IP2:IP3)	R/W	R/C	R/C
LW-10306	(16bit) : remote PLC 2's IP1 (IP address = IP0:IP1:IP2:IP3)	R/W	R/C	R/C
LW-10307	(16bit) : remote PLC 2's IP2 (IP address = IP0:IP1:IP2:IP3)	R/W	R/C	R/C
LW-10308	(16bit) : remote PLC 2's IP3 (IP address = IP0:IP1:IP2:IP3)	R/W	R/C	R/C
LW-10309	(16bit) : remote PLC 2's port no.	R/W	R/C	R/C
LW-10310	(16bit) : remote PLC 3's IP0 (IP address = IP0:IP1:IP2:IP3)	R/W	R/C	R/C
LW-10311	(16bit) : remote PLC 3's IP1 (IP address = IP0:IP1:IP2:IP3)	R/W	R/C	R/C
LW-10312	(16bit) : remote PLC 3's IP2 (IP address = IP0:IP1:IP2:IP3)	R/W	R/C	R/C
LW-10313	(16bit) : remote PLC 3's IP3 (IP address = IP0:IP1:IP2:IP3)	R/W	R/C	R/C
LW-10314	(16bit) : remote PLC 3's port no.	R/W	R/C	R/C
LW-10315	(16bit) : remote PLC 4's IP0 (IP address = IP0:IP1:IP2:IP3)	R/W	R/C	R/C
LW-10316	(16bit) : remote PLC 4's IP1 (IP address = IP0:IP1:IP2:IP3)	R/W	R/C	R/C
LW-10317	(16bit) : remote PLC 4's IP2 (IP address = IP0:IP1:IP2:IP3)	R/W	R/C	R/C
LW-10318	(16bit) : remote PLC 4's IP3 (IP address = IP0:IP1:IP2:IP3)	R/W	R/C	R/C

LW-10319	(16bit) : remote PLC 4's port no.	R/W	R/C	R/C
LW-10455	(16bit) : remote PLC 32's IP0 (IP address = IP0:IP1:IP2:IP3)	R/W	R/C	R/C
LW-10456	(16bit) : remote PLC 32's IP1 (IP address = IP0:IP1:IP2:IP3)	R/W	R/C	R/C
LW-10457	(16bit) : remote PLC 32's IP2 (IP address = IP0:IP1:IP2:IP3)	R/W	R/C	R/C
LW-10458	(16bit) : remote PLC 32's IP3 (IP address = IP0:IP1:IP2:IP3)	R/W	R/C	R/C
LW-10459	(16bit) : remote PLC 32's port no.	R/W	R/C	R/C

22.3.20. Local/Remote Operation Restrictions

Address	Description	Read(R)/Write(W)/Control(C)		
		Local HMI	Macro	Remote HMI
LB-9044	disable remote control (when ON)	R/W	R/C	R/C
LB-9053	prohibit password remote-read operation (when ON)	R/W	R/C	R/C
LB-9054	prohibit password remote-write operation (when ON)	R/W	R/C	R/C
LB-9196	local HMI supports monitor function only (when ON)	R/W	R/C	R/C
LB-9197	support monitor function only for remote HMIs (when ON)	R/W	R/C	R/C
LB-9198	disable local HMI to trigger a MACRO (when ON)	R/W	R/C	R/C
LB-9199	disable remote HMI to trigger a MACRO (when ON)	R/W	R/C	R/C

22.3.21. Communication Error Codes

Address	Description	Read(R)/Write(W)/Control(C)		
		Local HMI	Macro	Remote HMI
LW-9400	(16bit) : error code for PLC 1	R	R	R
LW-9401	(16bit) : error code for PLC 2	R	R	R
LW-9402	(16bit) : error code for PLC 3	R	R	R
LW-9403	(16bit) : error code for PLC 4	R	R	R
LW-9404	(16bit) : error code for PLC 5	R	R	R
LW-9405	(16bit) : error code for PLC 6	R	R	R
LW-9406	(16bit) : error code for PLC 7	R	R	R
LW-9407	(16bit) : error code for PLC 8	R	R	R
LW-9449	(16bit) : error code for PLC 50	R	R	R
LW-9490	(16bit) : error code for USB PLC	R	R	R
LW-9491	(16bit) : error code for CAN-Bus PLC	R	R	R

Note

1. A list of the explanation of PLC communication error codes:

Error Code	Cause of Communication Error
0	Normal
1	The device is busy and not yet ready to process a command.
2	Communication error due to unexpected reason.
3	The device does not exist.
4	The device using the specified station number does not exist.
5	Incorrect address format.
6	Read/Write unsupported address.
7	The driver of the device does not exist.
8	The COM port does not exist.
9	Incorrect IP address or unable to connect the device.
10	Checksum error.
11	Unidentified command.
12	Ignore
20	The USB device is improperly connected.
21	The CAN Bus device is improperly connected.
22	No reply from the device.
23	Insufficient data read from the device before timeout.
24	The Conversion Tag used by the object does not exist or the content is incorrect.
25	HMI is not accepting any commands from a remote HMI.
251	Read/Write exceeding number of words from/to the register of the MODBUS device.
252	MODBUS device replies incorrect data format.
253	MODBUS device checksum error.

22.3.22. Driver ID

Address	Description	Read(R)/Write(W)/Control(C)		
		Local HMI	Macro	Remote HMI
LW-9300	(16bit) : driver ID of local PLC 1	R	R	R
LW-9301	(16bit) : driver ID of local PLC 2	R	R	R
LW-9302	(16bit) : driver ID of local PLC 3	R	R	R
LW-9303	(16bit) : driver ID of local PLC 4	R	R	R
LW-9331	(16bit) : driver ID of local PLC 32	R	R	R

22.3.23. DLT645 Controller

Address	Description	Read(R)/Write(W)/Control(C)		
		Local HMI	Macro	Remote HMI
LW-10700	(4 words) : DLT_645 operator (COM 1)	R/W	R/C	R/C
LW-10704	(4 words) : DLT_645 password (COM 1)	R/W	R/C	R/C
LW-10708	(6 words) : DLT_645 address (COM 1)	R/W	R/C	R/C
LW-10715	(4 words) : DLT_645 operator (COM 2)	R/W	R/C	R/C
LW-10719	(4 words) : DLT_645 password (COM 2)	R/W	R/C	R/C
LW-10723	(6 words) : DLT_645 address (COM 2)	R/W	R/C	R/C
LW-10730	(4 words) : DLT_645 operator (COM 3)	R/W	R/C	R/C
LW-10734	(4 words) : DLT_645 password (COM 3)	R/W	R/C	R/C
LW-10738	(6 words) : DLT_645 address (COM 3)	R/W	R/C	R/C

22.3.24. [PLC No Response] Window Control

Address	Description	Read(R)/Write(W)/Control(C)		
		Local HMI	Macro	Remote HMI
LB-9192	disable USB PLC's "PLC No Response" dialog (when ON)	R/W	R/C	R/C
LB-11960	disable PLC 1's "PLC No Response" dialog (when ON)	R/W	R/C	R/C
LB-11961	disable PLC 2's "PLC No Response" dialog (when ON)	R/W	R/C	R/C
LB-11962	disable PLC 3's "PLC No Response" dialog (when ON)	R/W	R/C	R/C
LB-11963	disable PLC 4's "PLC No Response" dialog (when ON)	R/W	R/C	R/C
LB-11964	disable PLC 5's "PLC No Response" dialog (when ON)	R/W	R/C	R/C
LB-11965	disable PLC 6's "PLC No Response" dialog (when ON)	R/W	R/C	R/C
LB-11966	disable PLC 7's "PLC No Response" dialog (when ON)	R/W	R/C	R/C
LB-11967	disable PLC 8's "PLC No Response" dialog (when ON)	R/W	R/C	R/C
LB-12023	disable PLC 64's "PLC No Response" dialog (when ON)	R/W	R/C	R/C
LB-12082	disable CAN Bus device's "PLC No Response" dialog (when ON)	R/W	R/C	R/C

22.3.25. [Fast Selection] Window Control

Address	Description	Read(R)/Write(W)/Control(C)		
		Local HMI	Macro	Remote HMI
LB-9013	hide (set ON)/show (set OFF) FS window	R/W	R/C	R/C
LB-9014	hide (set ON)/show (set OFF) FS button	R/W	R/C	R/C
LB-9015	hide (set ON)/show (set OFF) FS window/button	R/W	R/C	R/C

22.3.26. EasyAccess

Address	Description	Read(R)/Write(W)/Control(C)		
		Local HMI	Macro	Remote HMI
LB-9051	disconnect (set OFF)/connect (set ON) EasyAccess server	R/W	R/C	R/C
LB-9052	status of connecting to EasyAccess server	R	R	R



For more information about EasyAccess, please visit <http://www.ihmi.net/>.



Click the icon to download the demo project. Please confirm your internet connection.

22.3.27. EasyAccess 2.0

Address	Description	Read(R)/Write(W)/Control(C)		
		Local HMI	Macro	Remote HMI
LW-10820	(16bit) : disable (set 0)/enable (set 1) (EasyAccess 2.0)	R/W	R/C	R/C
LW-10821	(5 words) : session ID (EasyAccess 2.0)	R/W	R/C	R/C
LW-10826	(2 words) : password (EasyAccess 2.0)	R/W	R/C	R/C
LW-10828	(16bit) : execution status (EasyAccess 2.0)	R	R	R
LW-10829	(16bit) : the last error code (EasyAccess 2.0)	R	R	R
LW-11170	(16bit) : Proxy Disable/Enable (0:disable, 1:enable) (EasyAccess 2.0)	R/W	R/C	R/C
LW-11171	(16bit) : Proxy Type (0:HTTP, 1:SOCKSv4, 2:SOCKSv5) (EasyAccess 2.0)	R/W	R/C	R/C
LW-11172	(16bit) : Proxy Server IP0 (EasyAccess 2.0)	R/W	R/C	R/C
LW-11173	(16bit) : Proxy Server IP1 (EasyAccess 2.0)	R/W	R/C	R/C
LW-11174	(16bit) : Proxy Server IP2 (EasyAccess 2.0)	R/W	R/C	R/C
LW-11175	(16bit) : Proxy Server IP3 (EasyAccess 2.0)	R/W	R/C	R/C
LW-11176	(16bit) : Proxy Server Port (EasyAccess 2.0)	R/W	R/C	R/C
LW-11177	(16bit) : Proxy authentication (0:disable, 1:enable) (EasyAccess 2.0)	R/W	R/C	R/C
LW-11178	(16 words) : Proxy username (EasyAccess 2.0)	R/W	R/C	R/C
LW-11194	(16 words) : Proxy password (EasyAccess 2.0)	R/W	R/C	R/C

LW-11210	(20 words) : Hardware key (EasyAccess 2.0)	R	R	R
LW-11296	(16bit) : Location of EasyAccess 2.0 server (0 : Global, 1 : China)	R	R	R

22.3.28. Remote Print/Backup Server

Address	Description	Read(R)/Write(W)/Control(C)		
		Local HMI	Macro	Remote HMI
LB-10069	forced to reconnect remote printer/backup server when IP changed on-line (set ON)	R/W	R/C	R/C
LB-12040	remote printer/backup server disconnection alarm (when ON)	R	R	R
LW-9770	(16bit) : remote printer/backup server IP0 (IP0:IP1:IP2:IP3)	R/W	R/C	R/C
LW-9771	(16bit) : remote printer/backup server IP1 (IP0:IP1:IP2:IP3)	R/W	R/C	R/C
LW-9772	(16bit) : remote printer/backup server IP2 (IP0:IP1:IP2:IP3)	R/W	R/C	R/C
LW-9773	(16bit) : remote printer/backup server IP3 (IP0:IP1:IP2:IP3)	R/W	R/C	R/C
LW-9774	(6 words) : remote printer/backup server user name <i>*Note 1</i>	R/W	R/C	R/C
LW-9780	(6 words) : remote printer/backup server password <i>*Note 1</i>	R/W	R/C	R/C

Note

1. When change settings using LW-9774 and LW-9780, please reboot HMI for the new settings to take effect.



Click the icon to download the demo project. Please confirm your internet connection.

22.3.29. Pass-Through Settings

Address	Description	Read(R)/Write(W)/Control(C)		
		Local HMI	Macro	Remote HMI
LW-9901	(16bit) : pass-through source COM port (1~3 : COM 1~COM 3)	R/W	R/C	R/C
LW-9902	(16bit) : pass-through destination COM port (1~3 : COM 1~COM 3)	R/W	R/C	R/C
LW-9903	(16bit) : pass-through control (0 : normal, 1 : pause, 2 : stop communications between HMI and PLC when executing pass-through)	R/W	R/C	R/C
LW-9904	(16bit) : pass-through server port no. (2000~2100)	R/W	R/C	R/C

LW-10850	(16bit) : disable/enable (0 : disable, 1 : normal, 2 : IP limited) (siemens pass-through)	R/W	R/C	R/C
LW-10851	(16bit) : destination COM port (siemens pass-through)	R/W	R/C	R/C
LW-10852	(16bit) : destination PLC station no. (siemens pass-through)	R/W	R/C	R/C
LW-10853	(16bit) : communication protocol (0 : invalid, 1 : PPI, 2 : MPI) (siemens pass-through)	R/W	R/C	R/C
LW-10854	(16bit) : IP0 of connecting client (IP address = IP0:IP1:IP2:IP3) (siemens pass-through)	R/W	R/C	R/C
LW-10855	(16bit) : IP1 of connecting client (IP address = IP0:IP1:IP2:IP3) (siemens pass-through)	R/W	R/C	R/C
LW-10856	(16bit) : IP2 of connecting client (IP address = IP0:IP1:IP2:IP3) (siemens pass-through)	R/W	R/C	R/C
LW-10857	(16bit) : IP3 of connecting client (IP address = IP0:IP1:IP2:IP3) (siemens pass-through)	R/W	R/C	R/C
LW-10858	(16bit) : IP0 of designated client (IP address = IP0:IP1:IP2:IP3) (siemens pass-through)	R/W	R/C	R/C
LW-10859	(16bit) : IP1 of designated client (IP address = IP0:IP1:IP2:IP3) (siemens pass-through)	R/W	R/C	R/C
LW-10860	(16bit) : IP2 of designated client (IP address = IP0:IP1:IP2:IP3) (siemens pass-through)	R/W	R/C	R/C
LW-10861	(16bit) : IP3 of designated client (IP address = IP0:IP1:IP2:IP3) (siemens pass-through)	R/W	R/C	R/C
LW-10862	(16bit) : connection status (0 : ready, 1 : client connecting) (siemens pass-through)	R	R	R
LW-10863	(16bit) : execution status (0 : normal, 1 : error) (siemens pass-through)	R	R	R
LW-10864	(16bit) : the last error (siemens pass-through)	R	R	R



For more information about Siemens pass-through feature, see “29 Pass-through”.



Click the icon to download the demo project. Please confirm your internet connection.

22.3.30. VNC Control

Address	Description	Read(R)/Write(W)/Control(C)		
		Local HMI	Macro	Remote HMI
LB-12088	enable VNC monitor mode (when ON) <i>*Note 1</i>	R/W	R/C	R/C
LB-12089	VNC pass word free (when ON) <i>*Note 1</i>	R/W	R/C	R/C

LB-12090	a VNC client connecting to HMI (when ON)(OS version 20120621 or later supports only)	R	R	R
LB-12091	disable auto-logout function when a VNC client connecting to HMI (when ON)(OS version 20120621 or later supports only)	R/W	R/C	R/C
LB-12092	enable VNC (set ON), disable VNC (set OFF)	R/W	R/C	R/C
LB-12093	VNC connection mode (OFF: single connection, ON: multi connection) (OS version 2013.05.09 or later support) *Note1	R/W	R/C	R/C
LW-9530	(4 words) : VNC server password	R/W	R/C	R/C

 **Note**

1. To change VNC mode, use LB-12092 to stop and then restart VNC to update the setting.

22.3.31. Project Key and HMI Key

Address	Description	Read(R)/Write(W)/Control(C)		
		Local HMI	Macro	Remote HMI
LB-9046	project key is different from HMI key (when ON)	R	R	R
LW-9046	(32bit) : HMI key *Note 1	R/W	R/C	R

 **Note**

1. When change HMI Key using LW-9046, please reboot HMI for the new settings to take effect.



Click the icon to download the demo project. Please confirm your internet connection.

22.3.32. USB Security Key

Address	Description	Read(R)/Write(W)/Control(C)		
		Local HMI	Macro	Remote HMI
LW-11160	(16bit) : start time of USB security key - year	R	R	R
LW-11161	(16bit) : start time of USB security key - month	R	R	R
LW-11162	(16bit) : start time of USB security key - day	R	R	R
LW-11163	(16bit) : start time of USB security key - hour	R	R	R
LW-11164	(16bit) : start time of USB security key - minute	R	R	R
LW-11165	(16bit) : expiration time of USB security key - year	R	R	R
LW-11166	(16bit) : expiration time of USB security key - month	R	R	R
LW-11167	(16bit) : expiration time of USB security key - day	R	R	R
LW-11168	(16bit) : expiration time of USB security key - hour	R	R	R
LW-11169	(16bit) : expiration time of USB security key - minute	R	R	R

22.3.33. User Name and Password

Address	Description	Read(R)/Write(W)/Control(C)		
		Local HMI	Macro	Remote HMI
LB-9050	user logout	W	C	C
LB-9060	password error	R	R	R
LB-9061	update password (set ON)	W	C	C
LB-12056	the user touches an unauthorized object (when ON)	R	R	R
PLB-12056	the user touches an unauthorized object (when ON) (on tablet)	R	R	R
LW-9082	(16bit) : auto logout time (unit : minute, 0 : disable the function)	R/W	R/C	R/C
LW-9219	(16bit) : user no. (1~12)	R/W	R/C	R/C
LW-9220	(32bit) : password	R/W	R/C	R/C
LW-9222	(16bit) : object classes can be operated for current user (bit 0:A, bit 1:B,bit 2:C, ...)	R	R	R
PLW-9222	(16bit) : object classes can be operated for current user (bit 0:A, bit 1:B,bit 2:C, ...)	R	N/A	N/A
LW-9500	(32bit) : user 1's password	R/W	R/C	R/C
LW-9502	(32bit) : user 2's password	R/W	R/C	R/C
LW-9504	(32bit) : user 3's password	R/W	R/C	R/C
LW-9506	(32bit) : user 4's password	R/W	R/C	R/C
LW-9508	(32bit) : user 5's password	R/W	R/C	R/C
LW-9510	(32bit) : user 6's password	R/W	R/C	R/C
LW-9512	(32bit) : user 7's password	R/W	R/C	R/C
LW-9514	(32bit) : user 8's password	R/W	R/C	R/C
LW-9516	(32bit) : user 9's password	R/W	R/C	R/C
LW-9518	(32bit) : user 10's password	R/W	R/C	R/C
LW-9520	(32bit) : user 11's password	R/W	R/C	R/C
LW-9522	(32bit) : user 12's password	R/W	R/C	R/C
LW-10754	(8 words) : current user name *Note 1	R	R	R
PLW-10754	(8 words) : current user name *Note 1	R	N/A	N/A

 **Note**

1. Only for [Security] » [Enhanced security mode].



Click the icon to download the demo project. Please confirm your internet connection.

22.3.34. Macro

Address	Description	Read(R)/Write(W)/Control(C)		
		Local HMI	Macro	Remote HMI
LB-9059	disable macro TRACE function (when ON) *Note1	R/W	R/C	R/C
LW-10900	(16bit) : macro 0 status (0:ready, 3:executing, 5:waiting response, 9:waiting sync, 17:delay, 32:abnormal end (exceed array size))	R	R	R
LW-10901	(16bit) : macro 1 status (0:ready, 3:executing, 5:waiting response, 9:waiting sync, 17:delay, 32:abnormal end (exceed array size))	R	R	R
LW-10902	(16bit) : macro 2 status (0:ready, 3:executing, 5:waiting response, 9:waiting sync, 17:delay, 32:abnormal end (exceed array size))	R	R	R
LW-10903	(16bit) : macro 3 status (0:ready, 3:executing, 5:waiting response, 9:waiting sync, 17:delay, 32:abnormal end (exceed array size))	R	R	R
LW-10904	(16bit) : macro 4 status (0:ready, 3:executing, 5:waiting response, 9:waiting sync, 17:delay, 32:abnormal end (exceed array size))	R	R	R
LW-10905	(16bit) : macro 5 status (0:ready, 3:executing, 5:waiting response, 9:waiting sync, 17:delay, 32:abnormal end (exceed array size))	R	R	R
LW-10906	(16bit) : macro 6 status (0:ready, 3:executing, 5:waiting response, 9:waiting sync, 17:delay, 32:abnormal end (exceed array size))	R	R	R
LW-10907	(16bit) : macro 7 status (0:ready, 3:executing, 5:waiting response, 9:waiting sync, 17:delay, 32:abnormal end (exceed array size))	R	R	R
LW-10908	(16bit) : macro 8 status (0:ready, 3:executing, 5:waiting response, 9:waiting sync, 17:delay, 32:abnormal end (exceed array size))	R	R	R
LW-10909	(16bit) : macro 9 status (0:ready, 3:executing, 5:waiting response, 9:waiting sync, 17:delay, 32:abnormal end (exceed array size))	R	R	R
LW-11154	(16bit) : macro 254 status (0:ready, 3:executing, 5:waiting response, 9:waiting sync, 17:delay, 32:abnormal end (exceed array size))	R	R	R

 **Note**

1. LB-9059: Disable macro trace function.



Click the icon to download the demo project. Please confirm your internet connection.

22.3.35. Input Object Function

Address	Description	Read(R)/Write(W)/Control(C)		
		Local HMI	Macro	Remote HMI
LW-9002	(32bit-float) : input high limit	R	R	R
LW-9004	(32bit-float) : input low limit	R	R	R
PLW-9052	(32bit-float) : the previous input value of the numeric input object	R	R	R
LW-9150	(32 words) : keyboard's input data (ASCII)	R	R	R
LW-9540	(16bit) : reserved for caps lock	R/W	R/C	R/C

22.3.36. Time Sync./Daylight Saving Time

Address	Description	Read(R)/Write(W)/Control(C)		
		Local HMI	Macro	Remote HMI
LB-12055	failed to execute time synchronization (when ON)	R	R	R
LB-12355	daylight saving time period (when ON)	R	R	R
LW-11260	(16bit) : enable/disable the daylight saving time (DST) (0:disable, 1:enable)	R/W	R/C	R/C
LW-11261	(16bit) : hour of the DST bias	R/W	R/C	R/C
LW-11262	(16bit) : minute of the DST bias	R/W	R/C	R/C
LW-11263	(16bit) : month of the year when DST starts	R/W	R/C	R/C
LW-11264	(16bit) : week of the month when DST starts (1~5)	R/W	R/C	R/C
LW-11265	(16bit) : day of the week when DST starts (0~ 6)	R/W	R/C	R/C
LW-11266	(16bit) : hour of local time when DST starts	R/W	R/C	R/C
LW-11267	(16bit) : minute of local time when DST starts	R/W	R/C	R/C
LW-11268	(16bit) : month of the year when DST ends	R/W	R/C	R/C
LW-11269	(16bit) : week of the month when DST ends (1~5)	R/W	R/C	R/C
LW-11270	(16bit) : day of the week when DST ends (0~6)	R/W	R/C	R/C
LW-11271	(16bit) : hour of local time when DST ends	R/W	R/C	R/C
LW-11272	(16bit) : minute of local time when DST ends	R/W	R/C	R/C
LW-11273	(16bit) : enable/disable time synchronization via NTP (Network Time Protocol) server (0:disable, 1:enable)	R/W	R/C	R/C
LW-11274	(16bit) : execute time synchronization when HMI starts (0:disable, 1:enable)	R/W	R/C	R/C
LW-11275	(16bit) : server response time has been adjusted in accordance with DST (0:disable, 1:enable)	R/W	R/C	R/C

LW-11276	(16bit) : HMI time zone (unit : minute)	R/W	R/C	R/C
LW-11277	(16bit) : server response time (server time zone) (unit : minute)	R/W	R/C	R/C
LW-11278	(16bit) : IP 0 of network time server 1 (IP address = IP0:IP1:IP2:IP3)	R/W	R/C	R/C
LW-11279	(16bit) : IP 1 of network time server 1 (IP address = IP0:IP1:IP2:IP3)	R/W	R/C	R/C
LW-11280	(16bit) : IP 2 of network time server 1 (IP address = IP0:IP1:IP2:IP3)	R/W	R/C	R/C
LW-11281	(16bit) : IP 3 of network time server 1 (IP address = IP0:IP1:IP2:IP3)	R/W	R/C	R/C
LW-11282	(16bit) : IP 0 of network time server 2 (IP address = IP0:IP1:IP2:IP3)	R/W	R/C	R/C
LW-11283	(16bit) : IP 1 of network time server 2 (IP address = IP0:IP1:IP2:IP3)	R/W	R/C	R/C
LW-11284	(16bit) : IP 2 of network time server 2 (IP address = IP0:IP1:IP2:IP3)	R/W	R/C	R/C
LW-11285	(16bit) : IP 3 of network time server 2 (IP address = IP0:IP1:IP2:IP3)	R/W	R/C	R/C
LW-11286	(16bit) : IP 0 of network time server 3 (IP address = IP0:IP1:IP2:IP3)	R/W	R/C	R/C
LW-11287	(16bit) : IP 1 of network time server 3 (IP address = IP0:IP1:IP2:IP3)	R/W	R/C	R/C
LW-11288	(16bit) : IP 2 of network time server 3 (IP address = IP0:IP1:IP2:IP3)	R/W	R/C	R/C
LW-11289	(16bit) : IP 3 of network time server 3 (IP address = IP0:IP1:IP2:IP3)	R/W	R/C	R/C
LW-11290	(16bit) : IP 0 of network time server 4 (IP address = IP0:IP1:IP2:IP3)	R/W	R/C	R/C
LW-11291	(16bit) : IP 1 of network time server 4 (IP address = IP0:IP1:IP2:IP3)	R/W	R/C	R/C
LW-11292	(16bit) : IP 2 of network time server 4 (IP address = IP0:IP1:IP2:IP3)	R/W	R/C	R/C
LW-11293	(16bit) : IP 3 of network time server 4 (IP address = IP0:IP1:IP2:IP3)	R/W	R/C	R/C
LW-11294	(32bit) : update interval (time synchronization interval) (10 ~ 86400, unit : second)	R/W	R/C	R/C

22.3.37. Cellular Data Network

Address	Description	Read(R)/Write(W)/Control(C)		
		Local HMI	Macro	Remote HMI
LW-11297	(16 words) : PIN code of SIM card (cellular network)	R/W	R/C	R/C
LW-11313	(16 words) : Access Point Name (cellular network)	R/W	R/C	R/C
LW-11329	(16 words) : username (cellular network)	R/W	R/C	R/C
LW-11345	(16 words) : password (cellular network)	R/W	R/C	R/C
LW-11361	(16 words) : dial number (cellular network)	R/W	R/C	R/C
LW-11377	(16bit) : stop (set 0)/start (set 1) connection (cellular network)	R/W	R/C	R/C
LW-11378	(16bit) : last error code (0:success, 1:incorrect PIN code, 2:no SIM, 3:no device, 4:puk locked, 5:other) (cellular network)	R	R	R
LW-11379	(16bit) : connection status (0:no device, 1:disconnect, 2:connecting, 3:connected) (cellular network)	R	R	R
LW-11380	(16bit) : stop (set 0)/start (set 1) connection (USB tethering)	R/W	R/C	R/C
LW-11381	(16bit) : connection status (0:no device, 1:disconnect, 2:connected, 3:fail, 4:OS not support, 5:HMI not support) (USB tethering)	R	R	R

22.3.38. Wi-Fi Setting

Address	Description	Read(R)/Write(W)/Control(C)		
		Local HMI	Macro	Remote HMI
LW-11383	(16bit) : Wi-Fi control (1: disconnect, 2: connect, 3: popup setting dialog)	R/W	R/C	R/C
LW-11384	(16bit) : Wi-Fi error code (0: no error, 1: no such device, 2. radio is off)	R	R	R
LW-11385	(16bit) : Wi-Fi status (0: stopped; 1: connecting; 2: connected)	R	R	R
LW-11386	(16 words) : Wi-Fi connected SSID	R	R	R
LW-11402	(16bit) : Wi-Fi signal level (0: none, 1: weak, 2: fair, 3: good, 4: excellent) (Wi-Fi) *Note2	R	R	R
LW-11403	(16bit) : Wi-Fi country code *Note1	R/W	R/C	R/C
LW-11404	(16bit) : Wi-Fi radio (0: Off, 1: On)	R/W	R/C	R/C
LW-11410	(16bit) : HMI Wi-Fi IP 0 (machine used only)	R/W	R/C	R/C

LW-11411	(16bit) : HMI Wi-Fi IP 1 (machine used only)	R/W	R/C	R/C
LW-11412	(16bit) : HMI Wi-Fi IP 2 (machine used only)	R/W	R/C	R/C
LW-11413	(16bit) : HMI Wi-Fi IP 3 (machine used only)	R/W	R/C	R/C
LW-11414	(16bit) : HMI Wi-Fi netmask 0 (machine used only)	R/W	R/C	R/C
LW-11415	(16bit) : HMI Wi-Fi netmask 1 (machine used only)	R/W	R/C	R/C
LW-11416	(16bit) : HMI Wi-Fi netmask 2 (machine used only)	R/W	R/C	R/C
LW-11417	(16bit) : HMI Wi-Fi netmask 3 (machine used only)	R/W	R/C	R/C
LW-11418	(16bit) : HMI Wi-Fi gateway 0 (machine used only)	R/W	R/C	R/C
LW-11419	(16bit) : HMI Wi-Fi gateway 1 (machine used only)	R/W	R/C	R/C
LW-11420	(16bit) : HMI Wi-Fi gateway 2 (machine used only)	R/W	R/C	R/C
LW-11421	(16bit) : HMI Wi-Fi gateway 3 (machine used only)	R/W	R/C	R/C
LW-11422	(16bit) : HMI Wi-Fi media access control (MAC) address 0	R	R	R
LW-11423	(16bit) : HMI Wi-Fi media access control (MAC) address 1	R	R	R
LW-11424	(16bit) : HMI Wi-Fi media access control (MAC) address 2	R	R	R
LW-11425	(16bit) : HMI Wi-Fi media access control (MAC) address 3	R	R	R
LW-11426	(16bit) : HMI Wi-Fi media access control (MAC) address 4	R	R	R
LW-11427	(16bit) : HMI Wi-Fi media access control (MAC) address 5	R	R	R
LW-11428	(16bit) : HMI Wi-Fi domain name system (DNS) server IP 0	R/W	R/C	R/C
LW-11429	(16bit) : HMI Wi-Fi domain name system (DNS) server IP 1	R/W	R/C	R/C
LW-11430	(16bit) : HMI Wi-Fi domain name system (DNS) server IP 2	R/W	R/C	R/C
LW-11431	(16bit) : HMI Wi-Fi domain name system (DNS) server IP 3	R/W	R/C	R/C
LW-11432	(16bit) : obtain an Wi-Fi IP address automatically (DHCP => 0 : off, 1 : on)	R/W	R/C	R/C

 **Note**

1. Please enter Wi-Fi country code in ASCII for uppercase letters, the setting will immediately take effect. Wireless regulations vary from country to country. The country code selection affects the list of channels of the wireless radio.
2. The signal strength is classified into four levels: 1. Weak (<-70 dBm), 2. Fair (-60 ~ -70 dBm), 3. Good (-50 ~ -60 dBm), 4. Excellent (>-50 dBm)

22.3.39. OPC UA Server

Address	Description	Read(R)/Write(W)/Control(C)		
		Local HMI	Macro	Remote HMI
LW-11435	(16bit) : OPC UA Server status (0: Stopped, 1: Started)	R	R	R
LW-11436	(16bit) : OPC UA Server error code (0: Success, 1 or more: Error)	R	R	R
LW-11437	(16bit) : OPC UA Server control command (0: None, 1: Start, 2: Stop)	R/W	R/C	R/C

22.3.40. e-Mail

Address	Description	Read(R)/Write(W)/Control(C)		
		Local HMI	Macro	Remote HMI
LB-12053	failed to send an [Event Log] e-Mail (when ON)	R	R	R
LB-12054	failed to send an [Backup Object] e-Mail (when ON)	R	R	R
LW-9216	(16bit) : the result of importing email data *Note 1	R	R	R
LW-11444	(16bit) : failed step (e-Mail) *Note 2	R	R	R
LW-11445	(16bit) : error code (e-Mail) *Note 3	R	R	R

 **Note**

- 1: import succeeded, 2: import failed (file doesn't exist)
- 2: Error codes of failed steps include:

Code	Cause of Error
0	CSMTP_NO_ERROR
100	WSA_STARTUP = Unable to initialise winsock2
101	WSA_VER = Wrong version of the winsock2
102	WSA_SEND = Function send() failed
103	WSA_RECV = Function recv() failed
104	WSA_CONNECT = Function connect failed
105	WSA_GETHOSTBY_NAME_ADDR = Unable to determine remote server
106	WSA_INVALID_SOCKET = Invalid winsock2 socket
107	WSA_HOSTNAME = Function hostname() failed
108	WSA_IOCTL_SOCKET = Function ioctlsocket() failed
109	WSA_SELECT
110	BAD_IPV4_ADDR = Improper IPv4 address
200	UNDEF_MSG_HEADER = Undefined message header
201	UNDEF_MAIL_FROM = Undefined mail sender

202	UNDEF_SUBJECT = Undefined message subject
203	UNDEF_RECIPIENTS = Undefined at least one recipient
204	UNDEF_RECIPIENT_MAIL = Undefined recipient mail
205	UNDEF_LOGIN = Undefined user login
206	UNDEF_PASSWORD = Undefined user password
207	BAD_LOGIN_PASSWORD = Invalid user login or password
208	BAD_DIGEST_RESPONSE = Server returned a bad digest MD5 response
209	BAD_SERVER_NAME = Unable to determine server name for digest MD5 response
300	COMMAND_MAIL_FROM = Server returned error after sending MAIL FROM
301	COMMAND_EHLO = Server returned error after sending EHLO
302	COMMAND_AUTH_PLAIN = Server returned error after sending AUTH PLAIN
303	COMMAND_AUTH_LOGIN = Server returned error after sending AUTH LOGIN
304	COMMAND_AUTH_CRAMMD5 = Server returned error after sending AUTH CRAM-MD5
305	COMMAND_AUTH_DIGESTMD5 = Server returned error after sending AUTH DIGEST-MD5
306	COMMAND_DIGESTMD5 = Server returned error after sending MD5 DIGEST
307	COMMAND_DATA = Server returned error after sending DATA
308	COMMAND_QUIT = Server returned error after sending QUIT
309	COMMAND_RCPT_TO = Server returned error after sending RCPT TO
310	MSG_BODY_ERROR = Error in message body
400	CONNECTION_CLOSED = Server has closed the connection
401	SERVER_NOT_READY = Server is not ready
402	SERVER_NOT_RESPONDING = Server not responding
403	SELECT_TIMEOUT =
404	FILE_NOT_EXIST = File not exist
405	MSG_TOO_BIG = Message is too big
406	BAD_LOGIN_PASS = Bad login or password
407	UNDEF_XYZ_RESPONSE = Undefined xyz SMTP response
408	LACK_OF_MEMORY = Lack of memory
409	TIME_ERROR = time() error
410	RECVBUF_IS_EMPTY = RecvBuf is empty
411	SENDBUF_IS_EMPTY = SendBuf is empty
412	OUT_OF_MSG_RANGE = Specified line number is out of message size
413	COMMAND_EHLO_STARTTLS = Server returned error after sending STARTTLS
414	SSL_PROBLEM = SSL problem
415	COMMAND_DATABLOCK = Failed to send data block

416	STARTTLS_NOT_SUPPORTED = The STARTTLS command is not supported by the server
417	LOGIN_NOT_SUPPORTED = AUTH LOGIN is not supported by the server

3. Error messages sent from mail server can be shown by designating a word address (length adjustable) in System Parameter Settings » e-Mail tab » [Error message].

22.3.41. Miscellaneous

Address	Description	Read(R)/Write(W)/Control(C)		
		Local HMI	Macro	Remote HMI
LB-9000~ LB-9009	initialized as ON	R/W	R/C	R/C
LB-9010	data-transfer write indicator	R	R	R
LB-9011	data-transfer read indicator	R	R	R
LB-9012	data-transfer execution indicator	R	R	R
LB-9016	status is on when a client connects to this HMI	R	R	R
LB-9017	disable write-back in PLC control's [change window]	R/W	R/C	R/C
LB-9039	status of file backup activity (backup in process if ON)	R	R	R
LB-9045	memory-map communication fails (when ON)	R	R	R
LB-9049	disable/enable watch dog (use LW-11456 set watch dog timeout) *Note 1	R/W	R/C	R/C
LB-12356	enable(set on)/disable(set off) web streaming	R/W	R/C	R/C
LB-12357	web streaming status (on: enabled / off: disabled)	R	R	R
LB-12358	enable (when ON) / disable (when OFF) off-line simulation on HMI *Note 5	R/W	R/C	R/C
LB-12361	status of operation log function (OFF : disabled, ON : enabled)	R/W	R/C	R/C
LW-9006	(16bit) : connected client no.	R	R	R
LW-9024	(16bit) : memory link system register	R/W	R/C	R/C
LW-9032	(8 words) : folder name of backup history files to SD, USB memory *Note 3	R/W	R/C	R/C
LW-9050	(16bit) : current base window ID	R	R	R
PLW-9050	(16bit) : current base window ID	R	R	R
LW-9134	(16bit) : language mode *Note 2	R/W	R/C	R/C
PLW-9134	(16bit) : language mode *Note 2	R/W	R/C	R/C
LW-9900	(16bit) : HMI run mode (0 : normal mode, 1-3 : test mode (COM 1-COM 3))	R/W	R/C	R/C
LW-10762	(8 words) : slot1 user name	R/W	R/C	R/C
LW-10770	(8 words) : slot2 user name	R/W	R/C	R/C
LW-10778	(8 words) : slot3 user name	R/W	R/C	R/C

LW-10814	(16bit) : connecting to a Weintek HMI (0:none, 1:connecting) *Note 4	R	R	R
LW-11456	(16bit) : watch dog timeout (3 ~ 10), unit : second *Note 1	R/W	R/C	R/C

Note

1. When LB-9049 watch dog function is enabled, watch dog automatically reboots the system after the HMI stops functioning for a specified period of time.
2. To display texts on objects in multiple languages, except for using Label Library, the system reserved register [LW-9134: language mode] is needed. The value range in LW-9134 is 0 ~ 23 (PLW-9134 is 0~7). The values in LW-9134 relates to the languages downloaded to HMI. LW-9134 value and language correspondence vary according to the languages selected during project compilation and download.
For example: If 5 languages are defined by user in Label Library as Language 1 (Traditional Chinese), Language 2 (Simplified Chinese), Language 3 (English), Language 4 (French), and Language 5 (Japanese). If only Language 1, 3, 5 are downloaded, the corresponding language of the value in LW-9134 will be 0 → Language 1 (Traditional Chinese), 1 → Language 3 (English), 2 → Language 5 (Japanese). The following demo project explains how to switch languages using Option List Object and LW-9134.



- Click the icon to download the demo project. Please confirm your internet connection.
3. The default name of the backup data folder will be the HMI name.
 4. When the USB Host is connected to a Weintek HMI, the address is set to 1, for testing if the USB Client of another Weintek HMI works normally.
 5. This register allows switching to off-line mode on HMI. In off-line mode, “PLC No Response” message will not show even when HMI is not properly connected. In this case, PLC related objects can still operate, however, the values are not read by / written to PLC.



23. HMI Supported Printers

This chapter describes the printers supported by HMI and the setup steps.

23.1. The Supported Printer Types	23-2
23.2. Steps to Add a New Printer and Start Printing	23-5
23.3. The Supported Printer Types on cMT3151	23-7

23.1. The Supported Printer Types

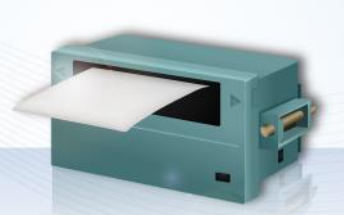
HMI supported printer drivers include the following types:

Printer type	Description
<ul style="list-style-type: none"> ● SP-M, D, E, F 	<p>Serial printers, please configure communication parameters to match the printer. [Pixels of width] must be correctly set and can't exceed printer default setting:</p> <p>100 pixels for 1610 series printers. 220 pixels for 2407, 4004 series printers.</p> <p>The driver uses EPSON ESC Protocol for Serial Micro Printer.</p>
<ul style="list-style-type: none"> ● EPSON ESC/P2 Series 	<p>Serial printers, please configure communication parameters to match the printer.</p> <p>The ESPON ESC/P2 printer protocol is used.</p> <p>Impact Printer: LQ-300, LQ-300+, LQ-300K+ (RS-232), LQ-300+II (RS-232) Inkjet Printer: Stylus Photo 750 Laser Printer: EPL-5800</p>
<ul style="list-style-type: none"> ● HP PCL Series (USB) 	<p>HP compatible USB printers that support HP PCL5 protocol or PostScript3 Printer Control Language.</p> <p>The printers that support PCL5 or later versions will support PCL5 protocol due to the downward compatibility of PCL.</p>

- **Axiohm A630**



Micro printer from France connects via serial port; please configure communication parameters to match the printer.

- **SPRT**



Serial printers, please configure communication parameters to match the printer. [Pixels of width] must be correctly set and can't exceed printer default setting "100".

- **EPSON TM-L90**



Serial printers, please configure communication parameters to match the printer. [Pixels of width] must be correctly set and can't exceed printer default setting "576".

- **EPSON TM-T70**



Serial printers, please configure communication parameters to match the printer. [Pixels of width] must be correctly set and can't exceed printer default setting "576".

The paper cutting mode can be selected: [No cut] / [Partial cut].

- **BRIGHTTEK WH-A19**



Supported models: A92R10-00E72A
72 in model number represents hexadecimal printer, and A represents wide voltage 5~9V. This is the same as the A6 16 impact printer.

- **BRIGHTTEK WH-E19**



Serial printers, please configure the same communication parameters as the printer.

- **BRIGHTTEK WH-E22**



Supported models:

E22R10-00E725: Same as A7 16 impact printer.

A7 represents A72R90-31E72A.

E221R90-00E11740GA: Serial printer, connects through RS-485 port, please use a RS232-to-RS485 converter.

- **BRIGHTTEK WH-C1/C2**



Serial printers, please configure communication parameters to match the printer. The paper cutting mode can be selected: [No cut] / [Half cut] / Full cut].

- **Remote Printer Server**



Use EasyPrinter to start printing by the printers connected with PC via Ethernet. This works under MS Windows so most printers on the market are supported.

23.2. Steps to Add a New Printer and Start Printing

1. Add printer type.
 - In [System Parameter Settings] » [Model] select the printer type and set the relevant parameters.

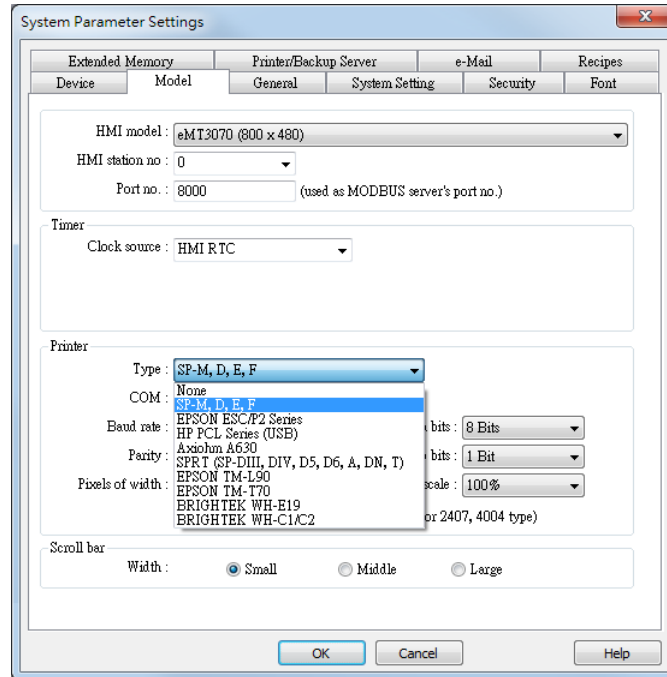

- To connect Remote Printer Server, set the parameters in [System Parameter Settings] » [Printer/Backup Server].

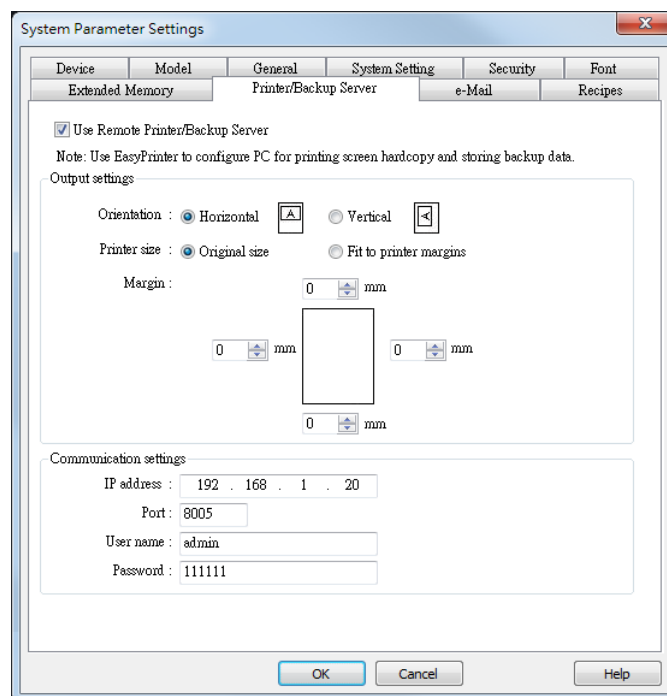

- 2. Start printing.
- Start printing with Function Key.

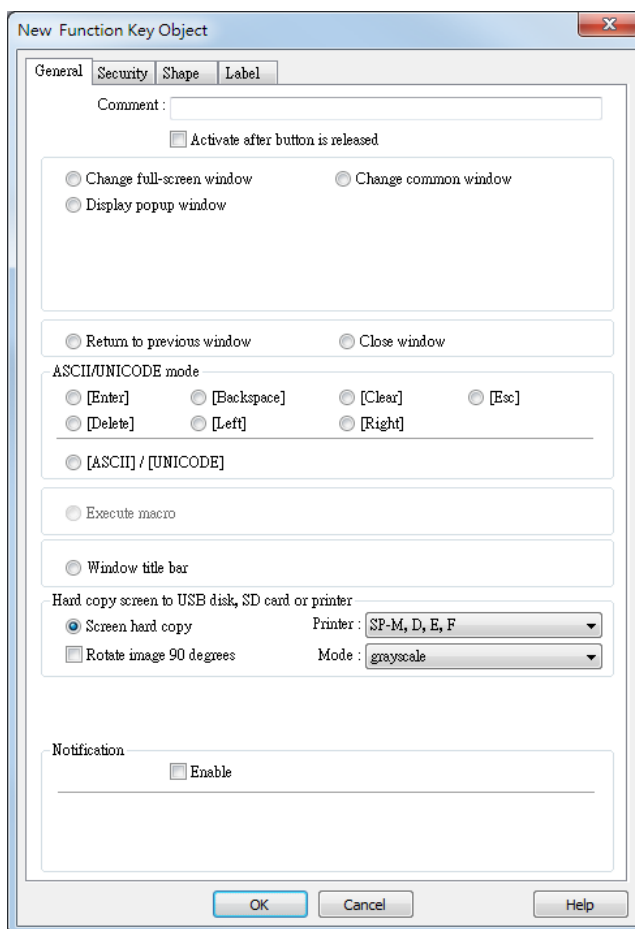

- Or, use PLC Control [Screen hardcopy] to start printing with a designated bit address.

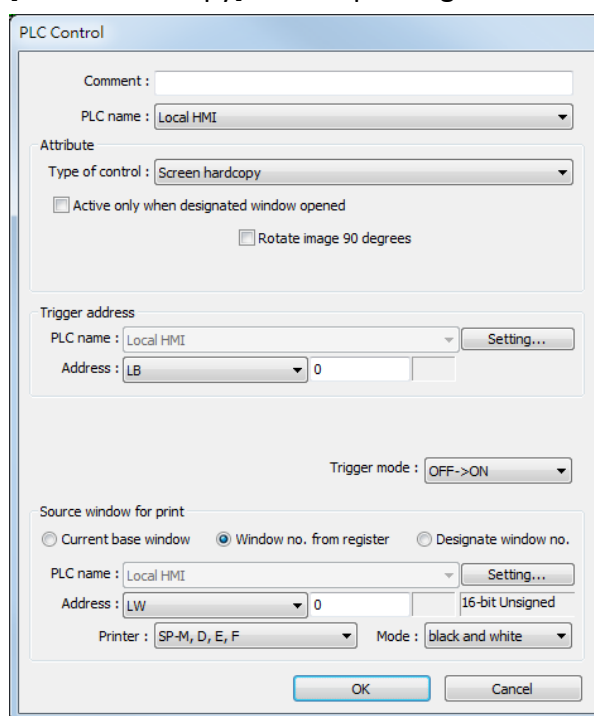

23.3. The Supported Printer Types on cMT3151

To connect cMT3151 with a printer, go to System Parameter Settings » Model tab.

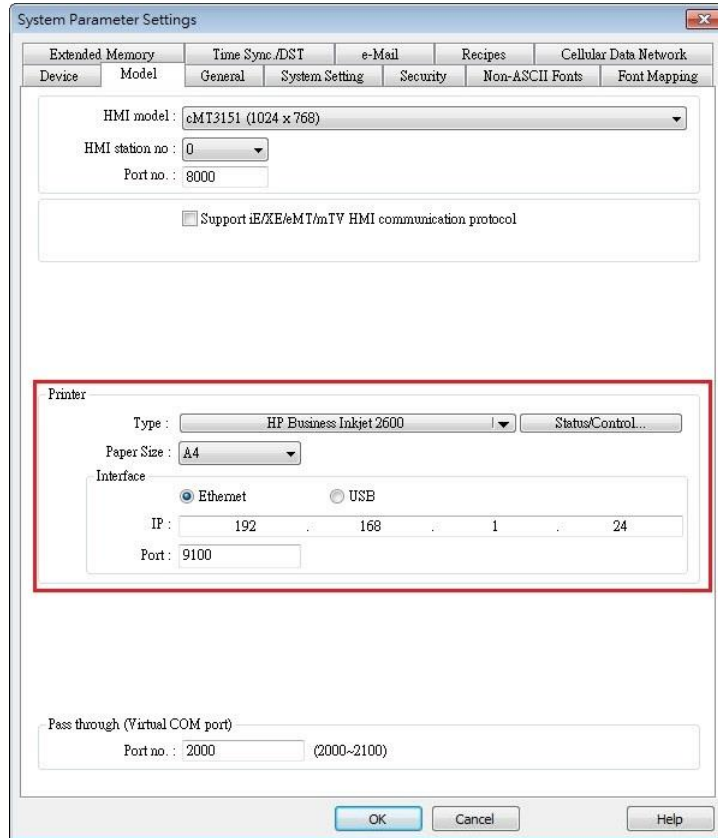

1. Select a printer type. To add a new printer, place the printer's PPD file in the ppd folder under EasyBuilder Pro installation directory, and then click [Refresh].

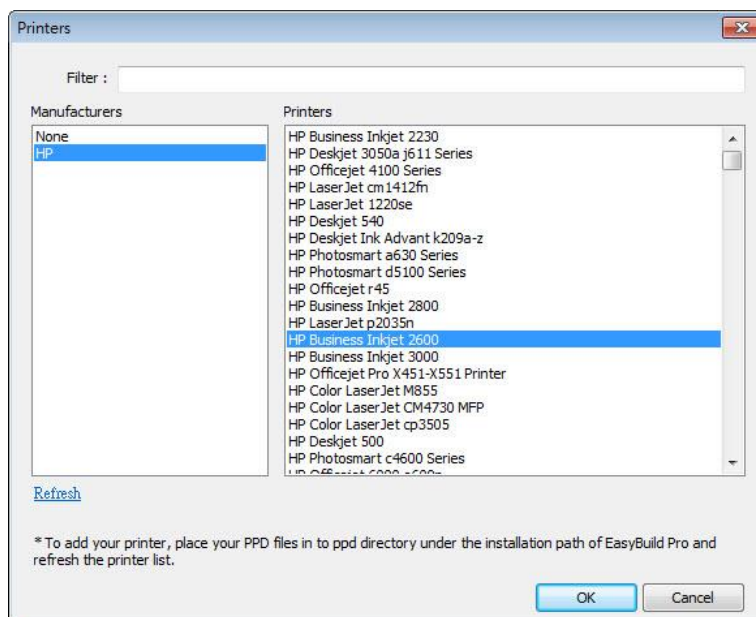

2. Use Status Address to monitor printer status, and use Control Address to dynamically update connection parameters.

Status/Control

Status address

Enable

PLC : Local HMI [Settings...]

Address : LW 0

Status : LW-0
(0 : not ready, 1 : initializing, 2 : ready, 3 : printing)

Error : LW-0 + 1
(0 : none, 1 : no device, 2 : unknown error)

Control address

Enable

PLC : Local HMI [Settings...]

Address : LW 10

Command : LW-0
(0 : none, 1 : update)

Interface : LW-0 + 1
(0 : Ethernet, 1 : USB)

IP : LW-0 + 2 (4 words)

Port : LW-0 + 6

OK Cancel

24. Recipe Editor

This chapter explains how to use Recipe Editor.

24.1. Overview	24-2
24.2. Recipe / Extended Memory Editor Setting	24-2
24.3. Recipe Records Setting	24-4

24.1. Overview

Recipe Editor is used to create, view, and edit recipe data.

EasyBuilder Pro also provides another tool for editing recipe: Recipe Records. To use this tool, first define a recipe in EasyBuilder Pro [System Parameter Settings] » [Recipe] tab, and then use [Recipe View Object] to display the content. The following introduces the usage of these two editing tools.

24.2. Recipe / Extended Memory Editor Setting

1. Open Utility Manager and click [Recipe/Extended Memory Editor].
2. To add new .rcp or .emi files, click [File] » [New].
3. Set address range and select data format.

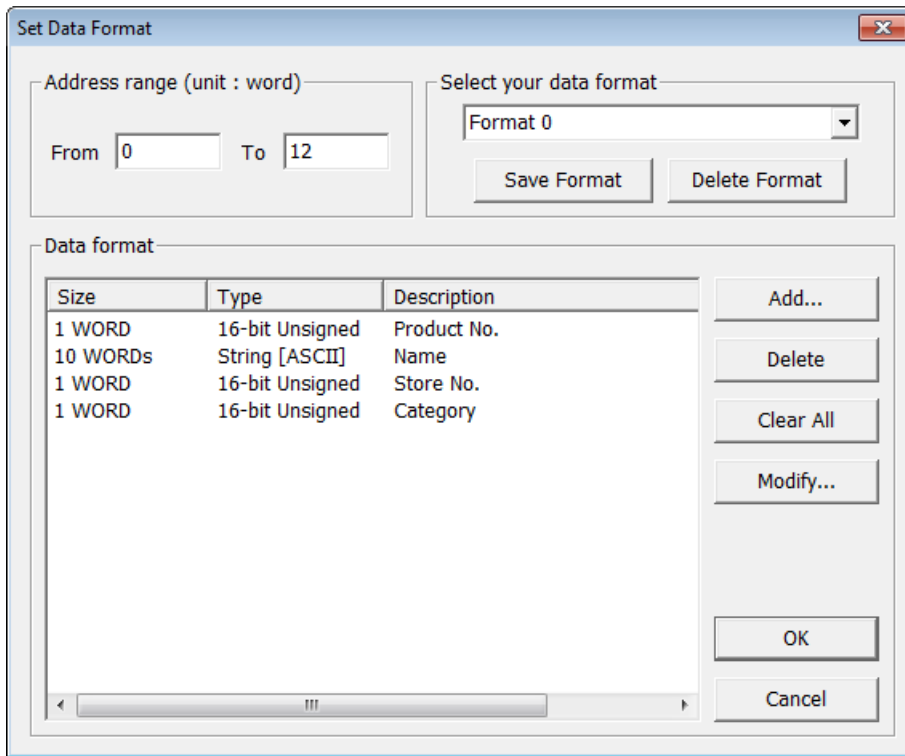

Setting	Description
Address range	Fill in address range, the unit of which is word.
Select your data format	Save the specified data format for loading next time. The saved file name is "dataEX.fmt" under EasyBuilder Pro's installation directory.
Data format	Edit new data format in this field.

- Click [Add] to enter a description of the data type, and select data format. When selecting [String], please enter the length (words) and select [ASCII] or [Unicode].

The 'Data Type' dialog box shows the following configuration:

- Description: Data 4
- Radio buttons for data formats:
 - 16-bit BCD
 - 32-bit BCD
 - 16-bit HEX
 - 32-bit HEX
 - 16-bit Unsigned** (selected)
 - 16-bit Signed
 - 32-bit Unsigned
 - 32-bit Signed
 - Float
 - String** (selected) with length '4' WORD(s)
 - ASCII** (selected)
 - Unicode
- Buttons: OK, Cancel

- After setup, click [OK] to start editing recipe data.

ID	ADDRESS	Product No.	Name	Store No.	Category
0	0	0	shampoo	9	4
1	13	1	knife	1	5
2	26	2	chair	3	2
3	39	3	coffee	3	3
4	52	4	pencil	6	5
5	65	5	muffin	6	3
6	78	6	donut	5	3
7	91	7	DVD	9	6
8	104	8	postcard	4	5
9	117	9	maps	5	5
10	130	10	camera	2	1

In this example, the total length of data format is 13 words. Each 13 words will be one set of recipe data.

The first set: "product no." = address 0, "Name" = address 1 ~ 10, "Store No." = address 11, "Category" = address 12;

The second set: "product no." = address 13, "Name" = address 14 ~ 23, "Store No." = address 24, "Category" = address 25;...and so on.

 Note

- After editing recipe data, it can be saved as .rcp, .emi, or .csv files. The .rcp files can be downloaded to HMI using Utility Manager or external devices (USB drive or SD card). The .emi files can be saved directly to the external device which is inserted to HMI as extended memory (EM).

24.3. Recipe Records Setting

1. Before using Recipe Records, first enable it in EasyBuilder Pro [System Parameter Settings] » [Recipes]. Please see “5 System Parameter Settings” for more detail.

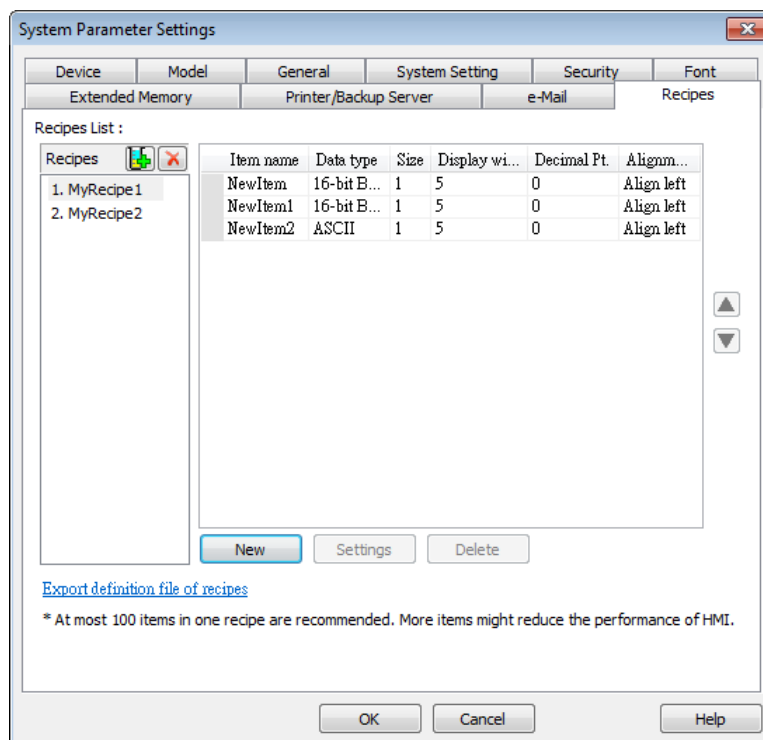

2. When finished, Recipe Records can be opened in main menu » [Library] » [Recipe Records]. In the example shown below, there are Recipe1 and Recipe2. Three items are shown on the right hand side. The names of recipe come from System Parameter Settings.

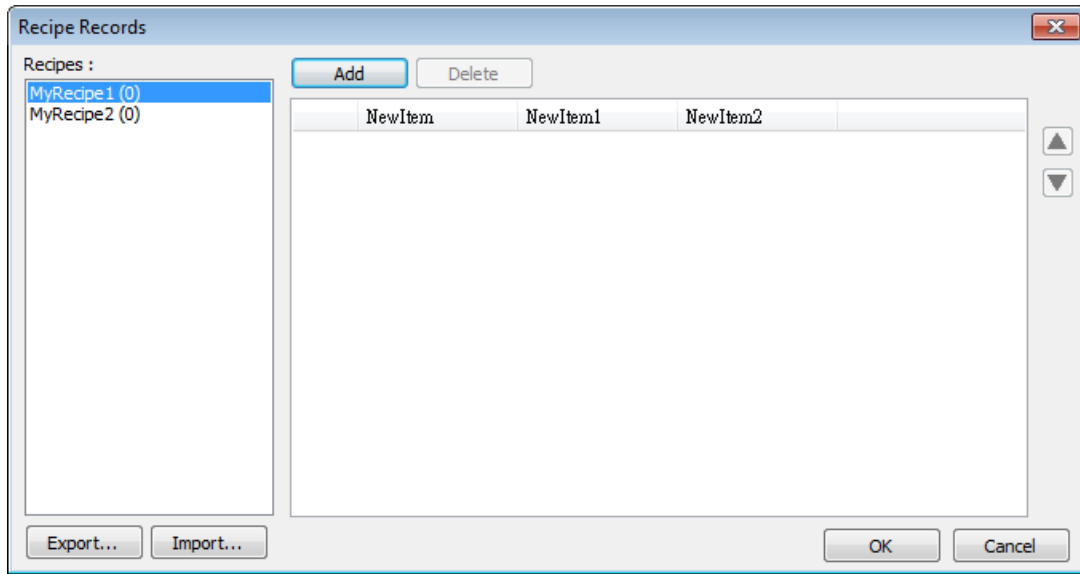

Setting	Description
Recipes:	The recipes created in System Parameter Settings. The number enclosed in brackets shows the total number of records in the corresponding recipe.
Add	Inserts records into the recipe according to the item format.
Delete	Deletes the edited content.
Up / Down Arrows	Moves the selected record upward / downward.

- To define recipes according to the specified format, click [Add] button above the record list to insert a new record and start editing each item. When click on the item, the item format will be shown under the record list. This helps users to fill in each item with legal value. Click [OK] to confirm and save the records.

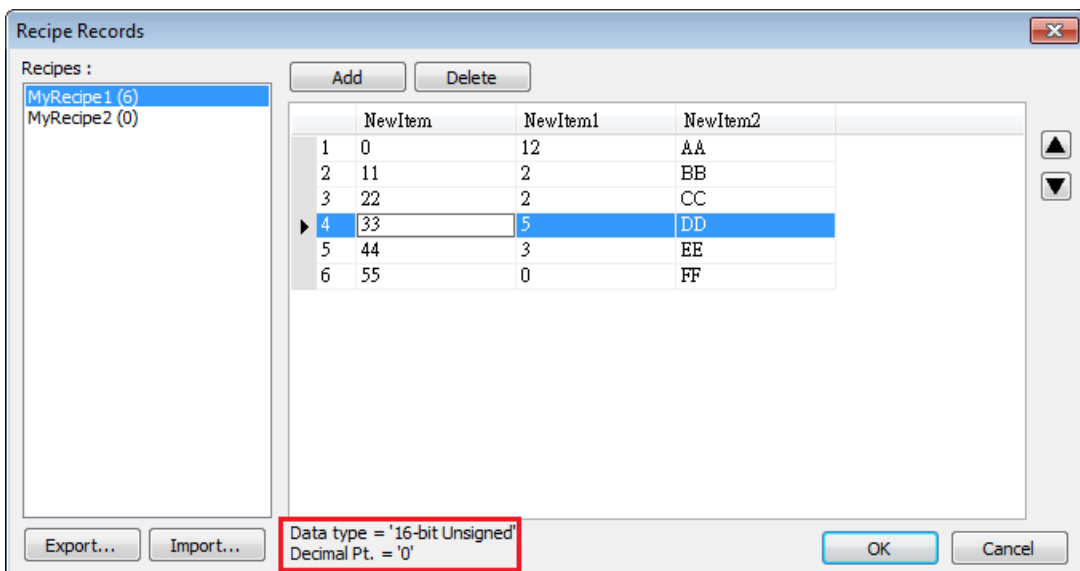

 **Note**

- Each recipe can hold a maximum of 10000 records.
- The recipe records will be stored in the .exob file after compilation and will be downloaded to HMI. These recipes cannot be shared with other project files. If users need to modify the recipe contents and download them to the HMI, make sure that [Reset recipe database] check box is selected during download. If not, the recipe database in the HMI will not be updated.

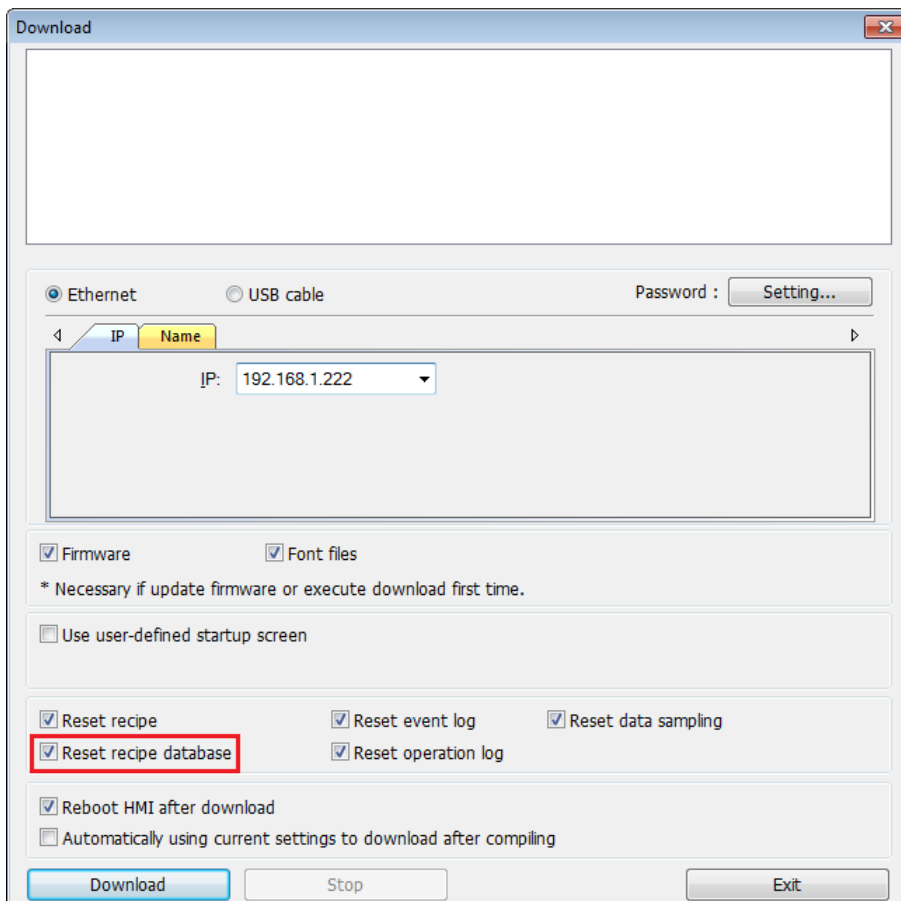

Download

Ethernet USB cable Password :

IP	Name
192.168.1.222	

Firmware Font files
* Necessary if update firmware or execute download first time.

Use user-defined startup screen

Reset recipe Reset event log Reset data sampling
 Reset recipe database Reset operation log

Reboot HMI after download
 Automatically using current settings to download after compiling

25. EasyConverter

This Chapter explains how to use EasyConverter.

25.1. Overview	25-2
25.2. Converting Data Log File to Excel File	25-2
25.3. Converting Event Log File to Excel File	25-4
25.4. Converting Operation Log File to Excel File	25-5
25.5. Converting Multiple Files.....	25-6
25.6. Scaling Function.....	25-8
25.7. Batch File	25-9

25.1. Overview

EasyConverter reads the Data Log file, Event Log file, and Operation Log file in HMI and convert the files to Excel format.

- From Utility ManagerEX click [Data Conversion] » [EasyConverter].
- From EasyBuilder Pro menu select [Tool] » [Data/Event Log Converter].

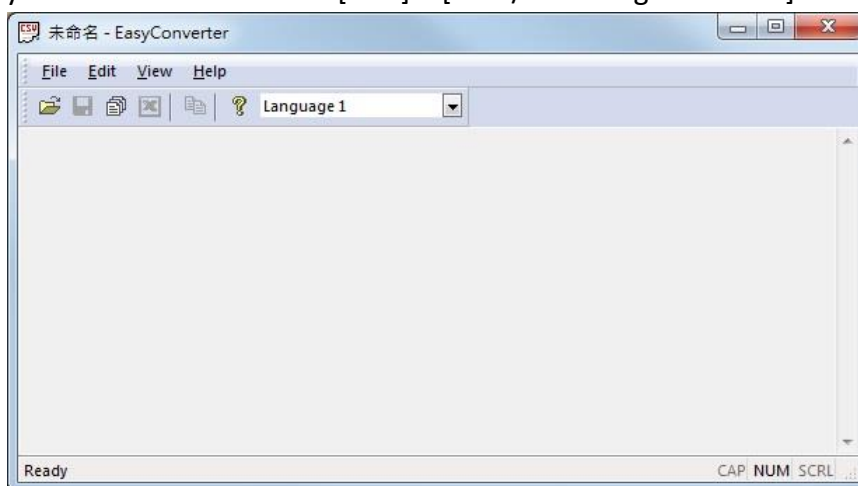

25.2. Converting Data Log File to Excel File

1. If the Data Log file format is .db, and the file includes data of more than one day, the data to be viewed can be specified by selecting a date range. (If the file format is .dtl, please skip this step.)

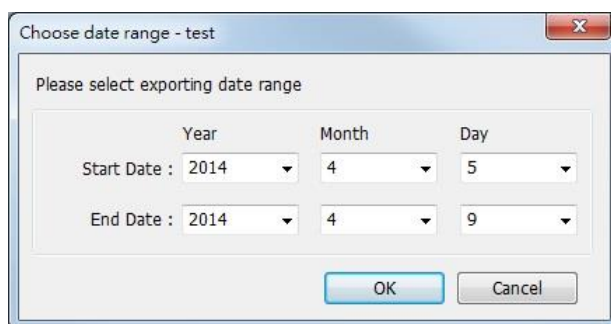

2. The following is the setting dialog box, please set based on actual needs.

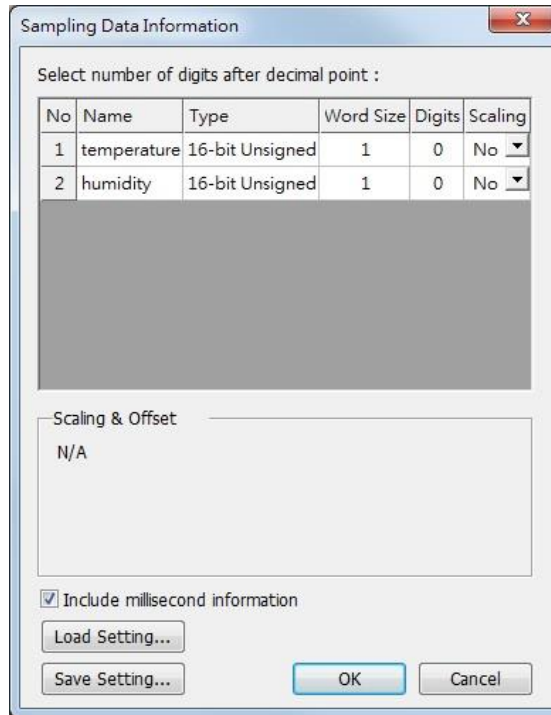

3. Click [OK], the Data Log layout is shown in the following figure. Click [Export to Excel]. The file will be converted to Excel format.

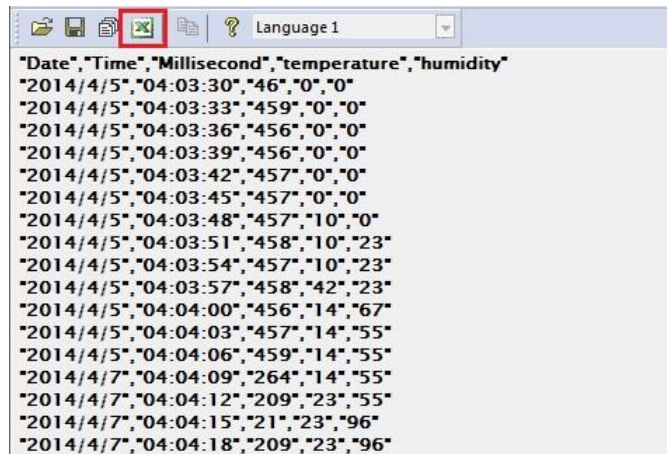

4. The Excel layout is shown in the following figure.

	A	B	C	D	E	F
1	Date	Time	Millisecond	temperature	humidity	
2	2014/4/5	4:03:30	46	0	0	
3	2014/4/5	4:03:33	459	0	0	
4	2014/4/5	4:03:36	456	0	0	
5	2014/4/5	4:03:39	456	0	0	
6	2014/4/5	4:03:42	457	0	0	
7	2014/4/5	4:03:45	457	0	0	
8	2014/4/5	4:03:48	457	10	0	
9	2014/4/5	4:03:51	458	10	23	
10	2014/4/5	4:03:54	457	10	23	
11	2014/4/5	4:03:57	458	42	23	
12	2014/4/5	4:04:00	456	14	67	
13	2014/4/5	4:04:03	457	14	55	
14	2014/4/5	4:04:06	459	14	55	
15	2014/4/7	4:04:09	264	14	55	
16	2014/4/7	4:04:12	209	23	55	
17	2014/4/7	4:04:15	21	23	96	

 **Note**

- If the file requires over six million cells in Excel format, only partial data will be shown in EasyConverter. (The complete data will still be exported to xls / xlsx file.)
- The file will be automatically separated into different sheets in the xls / xlsx file under these conditions:
 1. Exceeds 60 thousand rows in a single sheet.
 2. Exceeds 1.5 million cells in a single sheet.

25.3. Converting Event Log File to Excel File

1. If the Event Log file format is .db, and the file includes data of more than one day, the data to be viewed can be specified by selecting a date range.
(If the file format is .evt, please skip this step.)



2. If the .db file of Event Log contains multiple languages, the language to be viewed can be specified. (If the file format is .evt, please skip this step.)

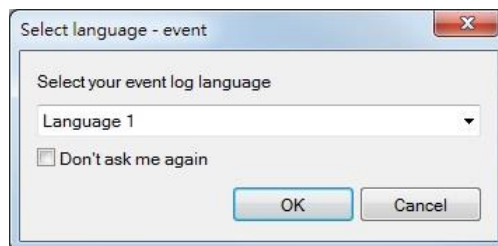

3. Click [OK], the Event Log layout is shown in the following figure. Click [Export to Excel]. The file will be converted to Excel format.

```

"Event","Category","Date","Time","Message"
"0","0","2014/4/5","04:03:28","Bit OFF"
"2","0","2014/4/5","04:03:31","Bit OFF"
"0","0","2014/4/5","04:03:31","Bit ON"
"2","0","2014/4/5","04:03:32","Bit ON"
"0","0","2014/4/5","04:03:32","Bit OFF"
"1","0","2014/4/5","04:03:33","Bit OFF"
"2","0","2014/4/5","04:03:35","Bit OFF"
"0","0","2014/4/5","04:03:35","Bit ON"
"1","0","2014/4/5","04:03:36","Bit ON"
"2","0","2014/4/5","04:03:38","Bit ON"
"0","0","2014/4/5","04:03:38","Bit OFF"
"2","0","2014/4/5","04:03:40","Bit OFF"
"0","0","2014/4/5","04:03:40","Bit ON"
"2","0","2014/4/7","04:04:15","Bit ON"
"0","0","2014/4/7","04:04:15","Bit OFF"
"2","0","2014/4/7","04:04:16","Bit OFF"
"0","0","2014/4/7","04:04:16","Bit ON"
    
```

4. The Excel layout is shown in the following figure.

	A	B	C	D	E	F
1	Event	Category	Date	Time	Message	
2	0	0	2014/4/5	4:03:28	Bit OFF	
3	2	0	2014/4/5	4:03:31	Bit OFF	
4	0	0	2014/4/5	4:03:31	Bit ON	
5	2	0	2014/4/5	4:03:32	Bit ON	
6	0	0	2014/4/5	4:03:32	Bit OFF	
7	1	0	2014/4/5	4:03:33	Bit OFF	
8	2	0	2014/4/5	4:03:35	Bit OFF	
9	0	0	2014/4/5	4:03:35	Bit ON	
10	1	0	2014/4/5	4:03:36	Bit ON	
11	2	0	2014/4/5	4:03:38	Bit ON	
12	0	0	2014/4/5	4:03:38	Bit OFF	
13	2	0	2014/4/5	4:03:40	Bit OFF	
14	0	0	2014/4/5	4:03:40	Bit ON	
15	2	0	2014/4/7	4:04:15	Bit ON	

 **Note**

- The "Event" column can be found. 0-> Event triggered; 1-> Event acknowledged; 2-> Event returns to normal.
- If the file requires over six million cells in Excel format, opening the file in EasyCoverter only partially shows the data. (The complete data will be exported to xls / xlsx file.)
- The file will be automatically separated into different sheets in the xls / xlsx file under these conditions:
 1. Exceeds 60 thousand rows in a single sheet.
 2. Exceeds 1.5 million cells in a single sheet.

25.4. Converting Operation Log File to Excel File

1. If the Operation Log file includes data of more than one day, the data to be viewed can be specified by selecting a date range.

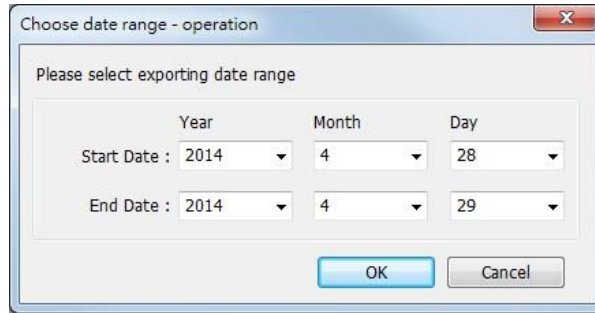

- Click [OK], the Operation Log layout is shown in the following figure. Click [Export to Excel]. The file will be converted to Excel format.

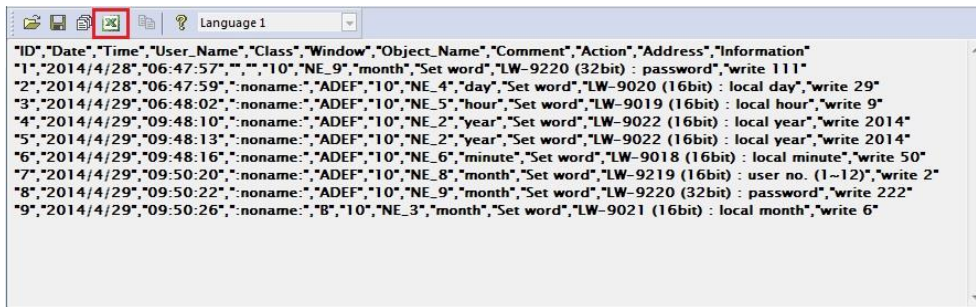

- The Excel layout is shown in the following figure.

ID	Date	Time	User Name	Class	Window	Object Name	Comment	Action	Address	Information
1	2014/4/28	6:47:57			10	NE_9	month	Set word	LW-9220 (32bit) : password	write 111
2	2014/4/28	6:47:59	noname:	ADEF	10	NE_4	day	Set word	LW-9020 (16bit) : local day	write 29
3	2014/4/29	6:48:02	noname:	ADEF	10	NE_5	hour	Set word	LW-9019 (16bit) : local hour	write 9
4	2014/4/29	9:48:10	noname:	ADEF	10	NE_2	year	Set word	LW-9022 (16bit) : local year	write 2014
5	2014/4/29	9:48:13	noname:	ADEF	10	NE_2	year	Set word	LW-9022 (16bit) : local year	write 2014
6	2014/4/29	9:48:16	noname:	ADEF	10	NE_6	minute	Set word	LW-9018 (16bit) : local minute	write 50
7	2014/4/29	9:50:20	noname:	ADEF	10	NE_8	month	Set word	LW-9219 (16bit) : user no. (1~12)	write 2
8	2014/4/29	9:50:22	noname:	ADEF	10	NE_9	month	Set word	LW-9220 (32bit) : password	write 222
9	2014/4/29	9:50:26	noname:	B	10	NE_3	month	Set word	LW-9021 (16bit) : local month	write 6

Note

- If the file requires over six million cells in Excel format, opening the file in EasyCoverter only partially shows the data. (The complete data will be exported to xls / xlsx file.)
- The file will be automatically separated into different sheets in the xls / xlsx file under these conditions:
 - Exceeds 60 thousand rows in a single sheet.
 - Exceeds 1.5 million cells in a single sheet.

25.5. Converting Multiple Files

- Click [Multi-File] to open the following dialog box.

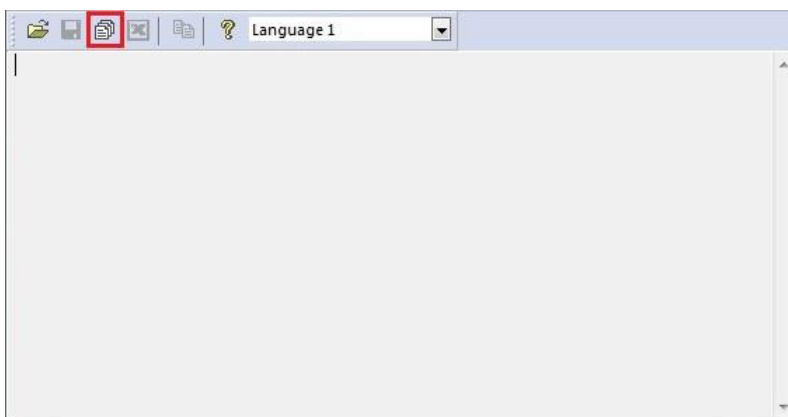

2. Click [Add File...] to add the files to be converted. If click [OK] without selecting [Combine to a file], the files will be exported to separate Excel files.

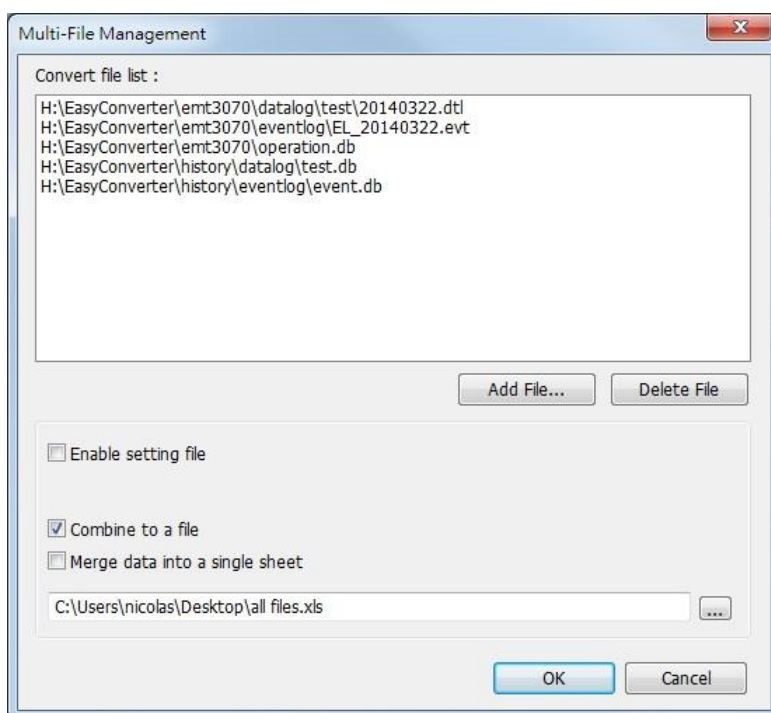

3. If [Combine to a file] is selected, the files will be separated into different sheets of one Excel file as shown in the following figure.

	A	B	C	D	E	F	G
1	Date	Time	Millisecond	temperature	humidity		
2	2014/3/22	6:36:52	260	2	1		
3	2014/3/22	6:36:55	250	6	3		
4	2014/3/22	6:36:58	250	10	6		
5	2014/3/22	6:37:01	300	13	8		
6	2014/3/22	6:37:04	280	17	10		
7	2014/3/22	6:37:07	250	21	13		
8							
9							
10							
11							
12							
13							
14							
15							

 **Note**

- The files cannot be combined when the total size of the files exceeds 32MB.

25.6. Scaling Function

When opening a Data Log file, the scaling function can be set.

The equation of scaling new value = $[(\text{value} + A) \times B] + C$, and users can set the values of A, B, and C.

A -> lower limit of the value ; B -> $[(\text{scaled max}) - (\text{scaled min}) / (\text{upper limit}) - (\text{lower limit})]$; C -> scaled min.

For example, here is a voltage data with a format of 16-bit unsigned (range: 0 ~ 4096).

To convert the data to volt, range form -5V to +5V, the new value = $[(\text{value} + 0) \times 0.0024] + (-5)$.

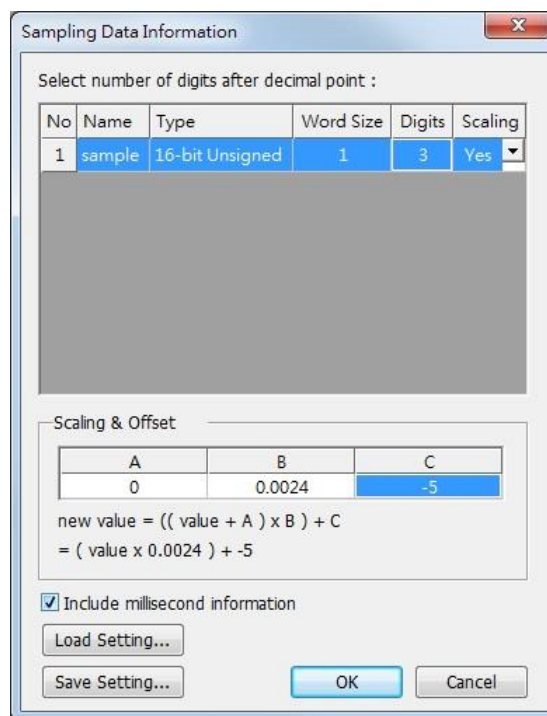

Before scaling:

```

"Date","Time","Millisecond","sample"
"2014/06/30","23:02:50","80","0"
"2014/06/30","23:02:54","30","0"
"2014/06/30","23:02:57","990","55"
"2014/06/30","23:03:02","70","55"
"2014/06/30","23:03:06","20","89"
"2014/06/30","23:03:10","20","159"
"2014/06/30","23:03:14","30","530"
"2014/06/30","23:03:18","20","898"
"2014/06/30","23:03:22","40","1024"
"2014/06/30","23:03:26","0","2055"
"2014/06/30","23:03:30","30","2055"

```

After scaling:

```

"Date","Time","Millisecond","sample"
"2014/06/30","23:02:50","80","-5.000"
"2014/06/30","23:02:54","30","-5.000"
"2014/06/30","23:02:57","990","-4.868"
"2014/06/30","23:03:02","70","-4.868"
"2014/06/30","23:03:06","20","-4.786"
"2014/06/30","23:03:10","20","-4.618"
"2014/06/30","23:03:14","30","-3.728"
"2014/06/30","23:03:18","20","-2.845"
"2014/06/30","23:03:22","40","-2.542"
"2014/06/30","23:03:26","0","-0.068"
"2014/06/30","23:03:30","30","-0.068"

```

The settings described above can be saved as a settings file in *.lgs format, and then loaded next time if needed.

25.7. Batch File

EasyConverter command line can execute batch file (.bat), and convert .dtl or .evt files into .xls or .csv files for export. In the batch file, the user can define the format of the exported file (ex: ASCII, Unicode, or UTF-8), and decide whether or not to include millisecond information or load settings file.

The following explains how to create batch file (.bat) and provides some relevant notes.

Parameters:

```
[/c{a,8,u}] [/t{0,1}] [/s "Format file"] ["Src file"] ["Dest file"]
```

Example:

```
EasyConverter.exe /ca /t1 /s "C:\Format.lgs" "C:\Src.dtl" "C:\Dest.csv"
```

```
EasyConverter.exe /t1 /s "C:\Format.lgs" "C:\Src.dtl" "C:\Dest.xls"
```

Parameter	Description
/c{a,8,u}	Optional, specifies encoding method, only required when exporting a .csv file. /ca : ASCII (Default) /c8 : UTF-8 /cu : Unicode
/t{0,1}	Optional, specifies whether or not to include millisecond information.

	/t0 : Excludes millisecond information.
	/t1 : Includes millisecond information. (Default)
/s	Optional, specifies whether or not to import settings file. To import settings file, specify the path of .lgs file following /s. For example: /s "C:\Format.lgs"
"Src file"	Specifies the source file path, and the file format should be: .dtl, .evt, or .db
"Dest file"	Specifies the destination file path, and the file format can be: .xls or .csv. See Note.

Note

- If the file name and path of "Dest file" is not specified in command line, the system will export the file to the same path as "Src file".

You can also find the commands above by entering the file path of EasyConverter.exe in Windows cmd.exe as shown in the following window.

Example: Enter "D:\EasyBuilder\EB Pro>EasyConverter.exe -h"

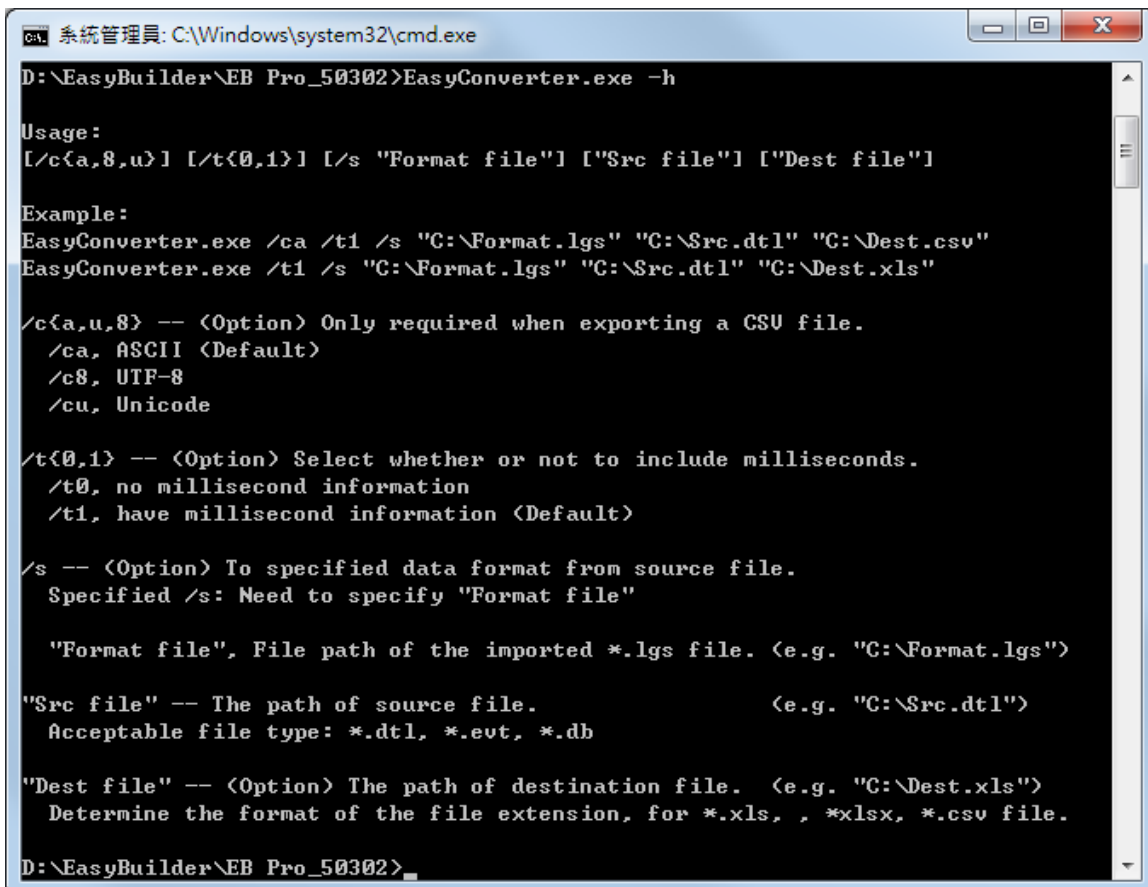

```

ct 系統管理員: C:\Windows\system32\cmd.exe
D:\EasyBuilder\EB Pro_50302>EasyConverter.exe -h

Usage:
[/c{a,8,u}] [/t{0,1}] [/s "Format file"] ["Src file"] ["Dest file"]

Example:
EasyConverter.exe /ca /t1 /s "C:\Format.lgs" "C:\Src.dtl" "C:\Dest.csv"
EasyConverter.exe /t1 /s "C:\Format.lgs" "C:\Src.dtl" "C:\Dest.xls"

/c{a,u,8} -- <Option> Only required when exporting a CSU file.
  /ca, ASCII <Default>
  /c8, UTF-8
  /cu, Unicode

/t{0,1} -- <Option> Select whether or not to include milliseconds.
  /t0, no millisecond information
  /t1, have millisecond information <Default>

/s -- <Option> To specified data format from source file.
  Specified /s: Need to specify "Format file"

  "Format file", File path of the imported *.lgs file. (e.g. "C:\Format.lgs")

"Src file" -- The path of source file. (e.g. "C:\Src.dtl")
  Acceptable file type: *.dtl, *.evt, *.db

"Dest file" -- <Option> The path of destination file. (e.g. "C:\Dest.xls")
  Determine the format of the file extension, for *.xls, , *xlsx, *.csv file.

D:\EasyBuilder\EB Pro_50302>

```

Example

To convert the file 20150919 stored in "D:\EasyBuilder\EB Pro\HMI_memory" from .dtl to .xls, and then save the file to the desktop, you can use the following command lines.

Scene 1: If the .bat file is placed in the same directory as EasyConverter, then the command line is:

```
EasyConverter.exe "D:\EasyBuilder\EB Pro\HMI_memory\20150919.dtl"  
"C:\Users\Desktop\20150919.xls"
```

Scene 2: If the .bat file is placed in a different directory from EasyConverter, the directory to store EasyConverter.exe. must be specified, and the command line will be:

```
"D:\EasyBuilder\EB Pro\EasyConverter.exe" "D:\EasyBuilder\EB  
Pro\HMI_memory\20150919.dtl" "C:\Users\Desktop\20150919.xls"
```

26. EasyPrinter

This chapter explains the setup steps of EasyPrinter.

26.1. Overview.....	26-2
26.2. Using EasyPrinter as a Printer Server	26-3
26.3. Using EasyPrinter as a Backup Sever	26-5
26.4. EasyPrinter Operation Guide	26-10
26.5. Convert Batch File.....	26-15

26.1. Overview

EasyPrinter is a Win32 application and can only run on MS Windows 2000 / XP / Vista / 7 / 8. It enables HMI to output screen hardcopies to a remote PC via Ethernet. The following explains how to use EasyPrinter.

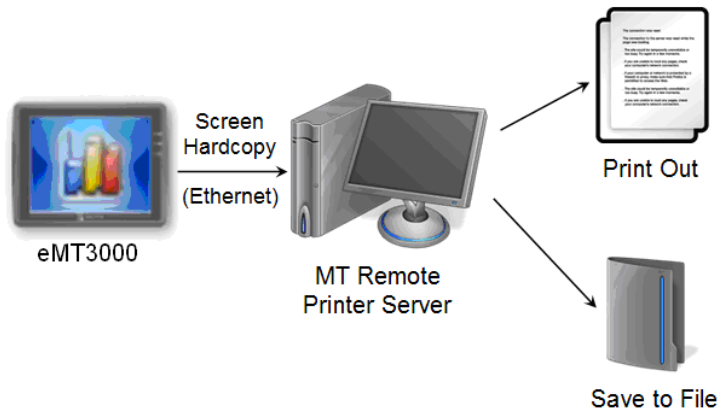

Here are some advantages of using EasyPrinter:

- EasyPrinter provides two modes of hardcopy output: [Print Out] and [Save to File]. Users can use either or both modes.
- Since EasyPrinter runs on MS Windows system, it supports most of the printers available on the market.
- Multiple HMIs can share one printer so users don't have to prepare printers for each HMI.

Additionally, EasyPrinter can also be a backup server. Users can use Backup objects on HMI to copy history files such as Data Sampling records and Event Log to a remote PC via Ethernet. Please see the following illustration:

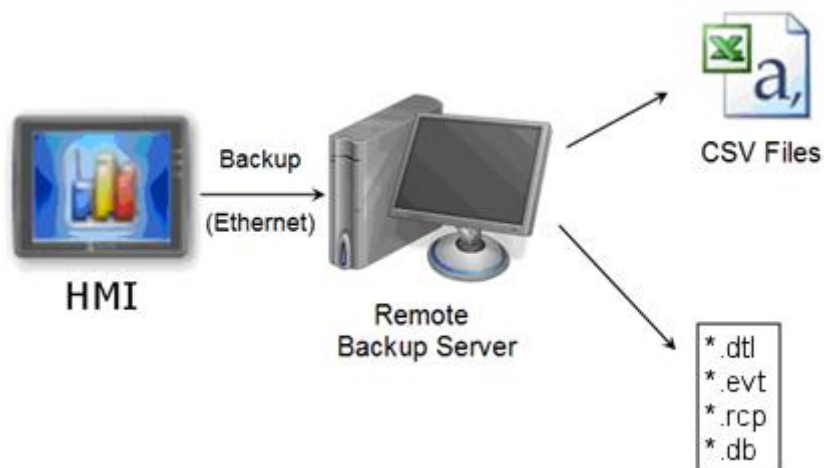

26.2. Using EasyPrinter as a Printer Server

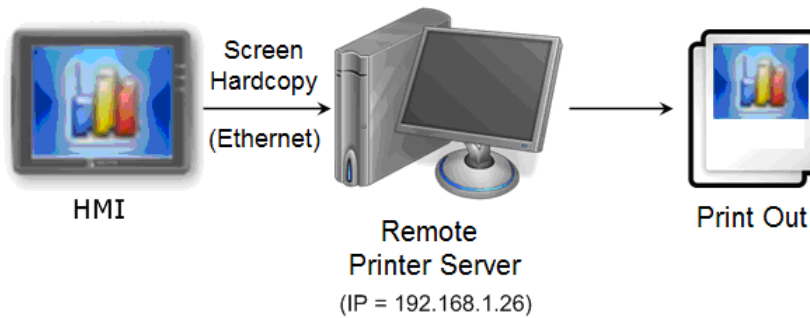

Users can make screen hardcopies with a Function Key object. The hardcopies will be transferred to the Remote Printer Server via Ethernet and then printed out.

26.2.1. Setup Procedure in EasyPrinter

In EasyPrinter's main menu, select [Options] » [Settings] and the following dialog box appears:

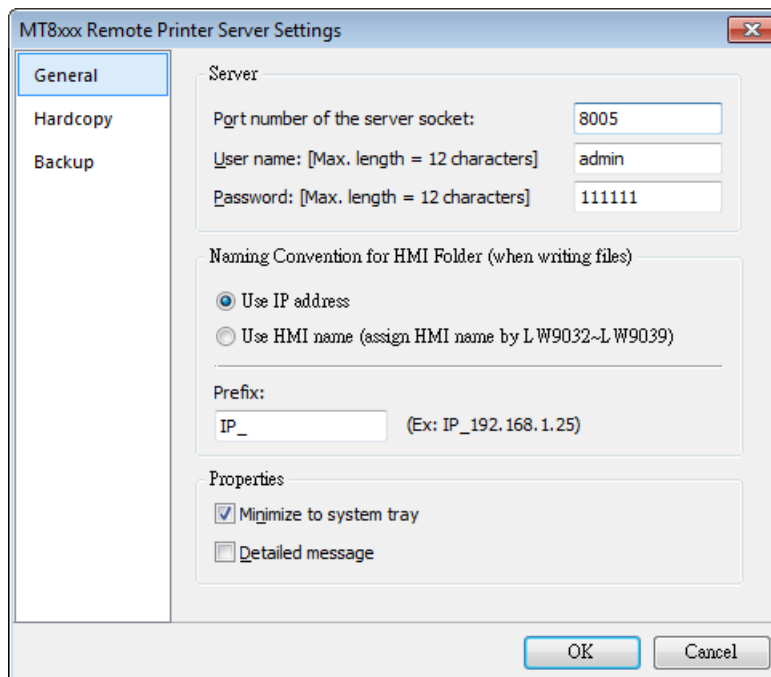

1. Select [General] on the left hand side.
2. In [Server], set [Port number of the server socket] to "8005", [User name] to "admin" and [Password] to "111111". (These are default values.)
3. In [Naming Convention for HMI Folder], select [Use IP address] and enter "IP_" in the [Prefix] field.
4. In [Properties], select [Minimize to system tray] check box.

Set the print out location.

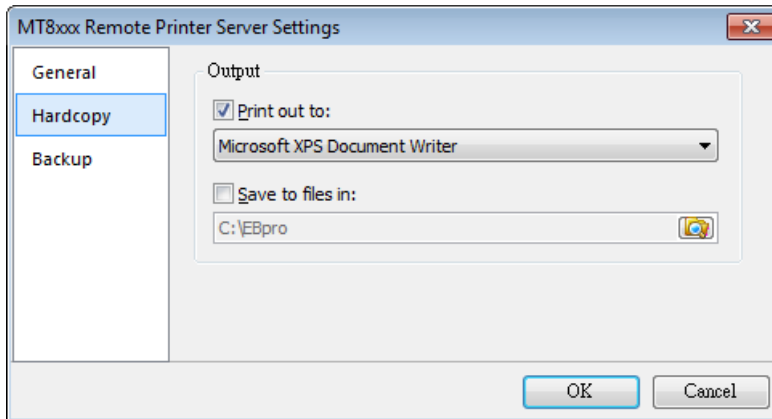

1. Select [Hardcopy] on the left hand side.
2. Under [Output] select [Print out to] and choose a printer as the output device for screen hardcopies. (The printer shown in the image above is an example; please select an actual printer located in your network environment.)
3. Click [OK] to confirm the settings.
4. In EasyPrinter main menu select [File] » [Enable Output] to output any incoming print request.

26.2.2. Setup Procedure in EasyBuilder Pro

The setting procedure of EasyPrinter in EasyBuilder Pro:

1. Open a new project or an existing project in EasyBuilder Pro.
2. In EasyBuilder Pro main menu select [Edit] » [System Parameter Settings] » [Printer/Backup Server] and select [Use Remote Printer/Backup Server] check box.

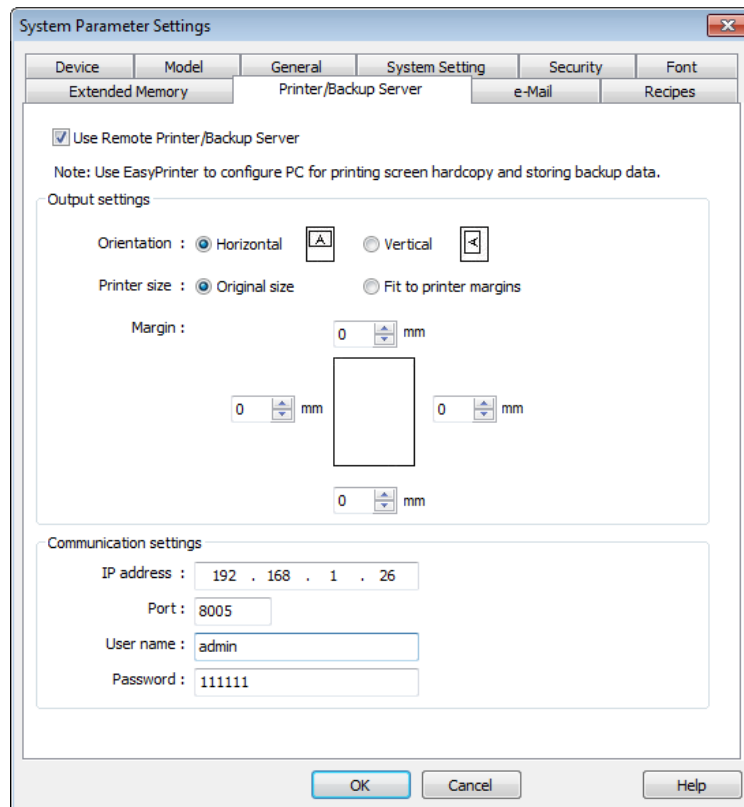

3. Under [Output settings] set appropriate values for left / top / right / bottom margins. (The margins are all set to 15mm in the example.)
4. Under [Communication settings] fill in the [IP address] of the printer server according to the settings in EasyPrinter. Set [Port] to “8005”, [User name] to “admin” and [Password] to “111111”.
5. Click [OK].
6. In EasyBuilder Pro main menu select [Objects] » [Button], select [Function Key], select [Screen hardcopy] and set [Printer] to [MT Remote Printer/Backup Server].

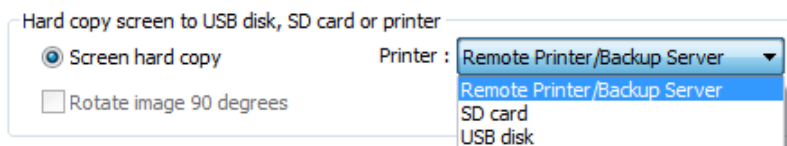

7. Place the Function Key object in the common window (window no. 4) so that screen hardcopies can be captured anytime when needed.
8. Compile and download the project to HMI. Press the Function Key object on the screen to make a screen hardcopy.

Note

- A PLC Control object can also be used to make screen hardcopies.
- Alarm information cannot be printed via EasyPrinter.
- EasyPrinter can only communicate with HMI via Ethernet. Please check that the HMI has appropriate network settings.

26.3. Using EasyPrinter as a Backup Sever

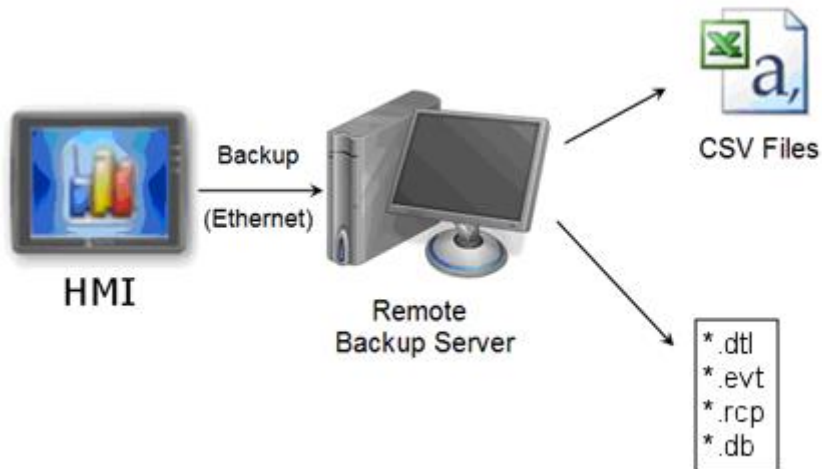

Backup objects can upload historical data and Operation Log to remote backup server.

26.3.1. Setup Procedure in EasyPrinter

In EasyPrinter's main menu, select [Objects] » [Settings] and the following dialog box will appear:

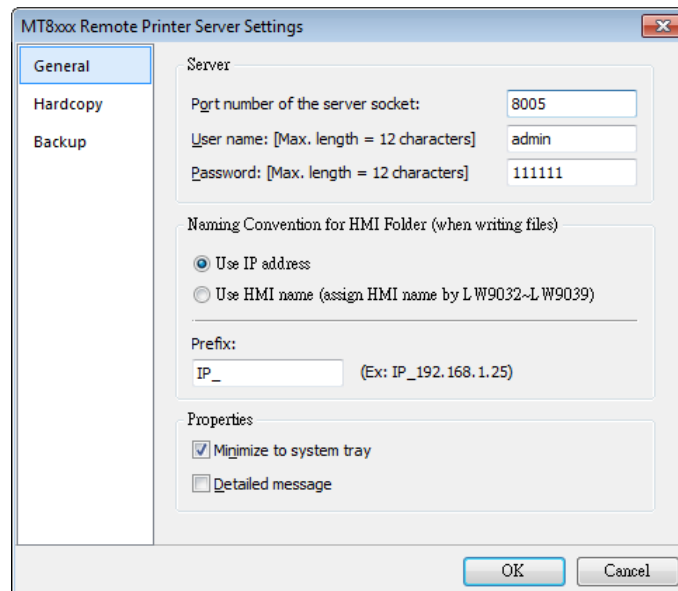

1. Select [General] on the left hand side.
2. Under [Server] set [Port number of the server socket] to “8005”, [User name] to “admin” and [Password] to “111111”. (These are default values.)
3. Under [Naming Convention for HMI Folder] select [Use IP address] and enter “IP_” in the [Prefix] field.

4. Under [Properties] select [Minimize to system tray].

Set the backup location.

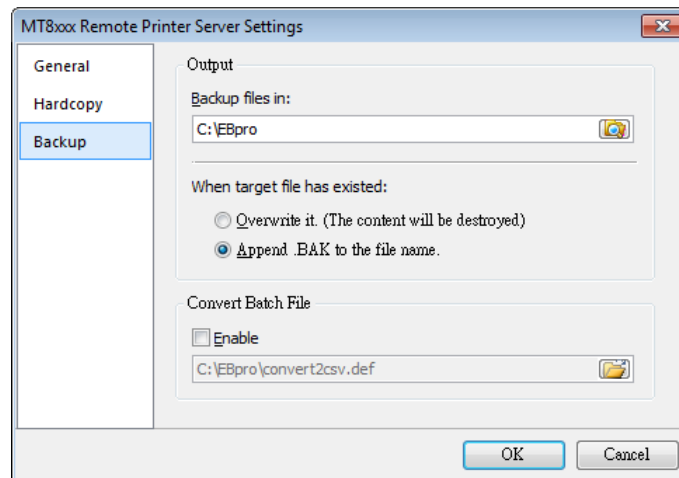

1. Select [Backup] on the left.
2. Under [Output] click the  button to browse and select a storage directory of the incoming history files.
3. Click [OK] to confirm the settings.
4. In the main menu, select [File] » [Enable Output] to backup data in the selected directory.

26.3.2. Setup Procedure in EasyBuilder Pro

The setup procedure of EasyPrinter in EasyBuilder Pro:

1. Open a new project or an existing project in EasyBuilder Pro.
2. In EasyBuilder Pro's main menu, select [Edit] » [System Parameter Settings] » [Printer/Backup Server] and select the [Use Remote Printer/Backup Server] check box.

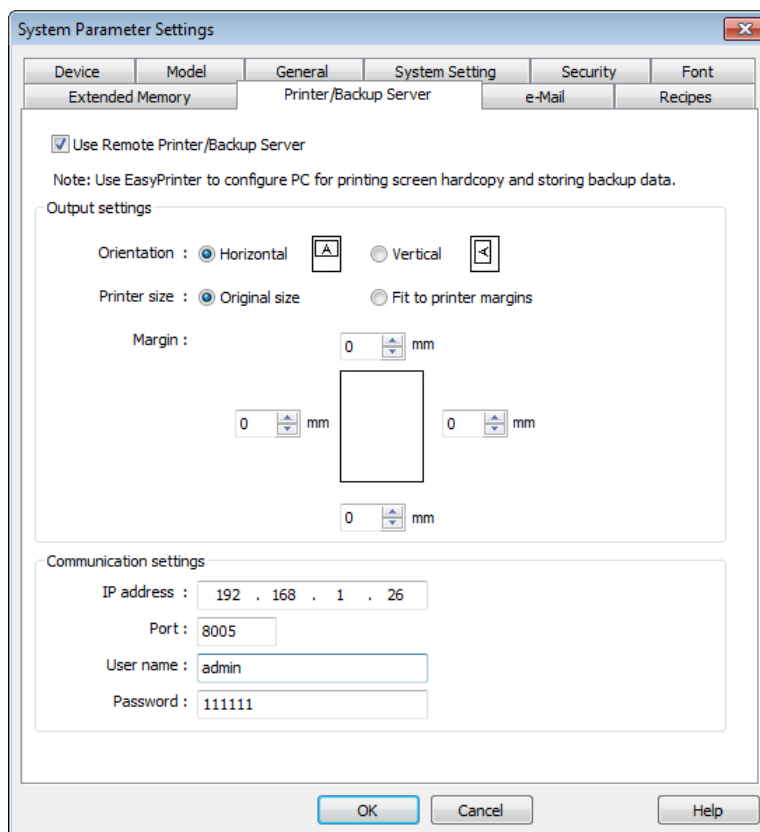

3. Under [Communication settings] fill in the [IP address] of the printer server according to the settings in EasyPrinter. Set the [Port] to “8005”, [User name] to “admin” and [Password] to “111111”. (Note: These are default values.)
4. Click [OK].

Create a Backup object.

1. In EasyBuilder Pro’s main menu, select [Objects] » [Backup] and the following dialog box appears:

2. Under [Source] select [Historical event log] (or [RW], [RW_A] if needed.)
3. Under [Backup position] select [Remote printer/backup server].
4. Under [Range] select [Today] and [All] (or other options if needed.)
5. Under [Trigger] select [Touch trigger].
6. Click [OK].
7. Place the [Backup] object in the common window (window no. 4), and users will be able to make backups anytime when needed.
8. Compile and download the project to HMI. Press the Backup object on the screen to make a backup of the history data.

Note

- The Backup object can also be triggered by a bit address.
- Users can arrange a Scheduler object, which turns a bit ON at the end of a week, to trigger the Backup object to automatically back up all history data.

26.4. EasyPrinter Operation Guide

The following introduces the interface and operation of EasyPrinter.

26.4.1. EasyPrinter Managing Window

EasyPrinter main menu is divided into 5 parts as shown in the following figure:

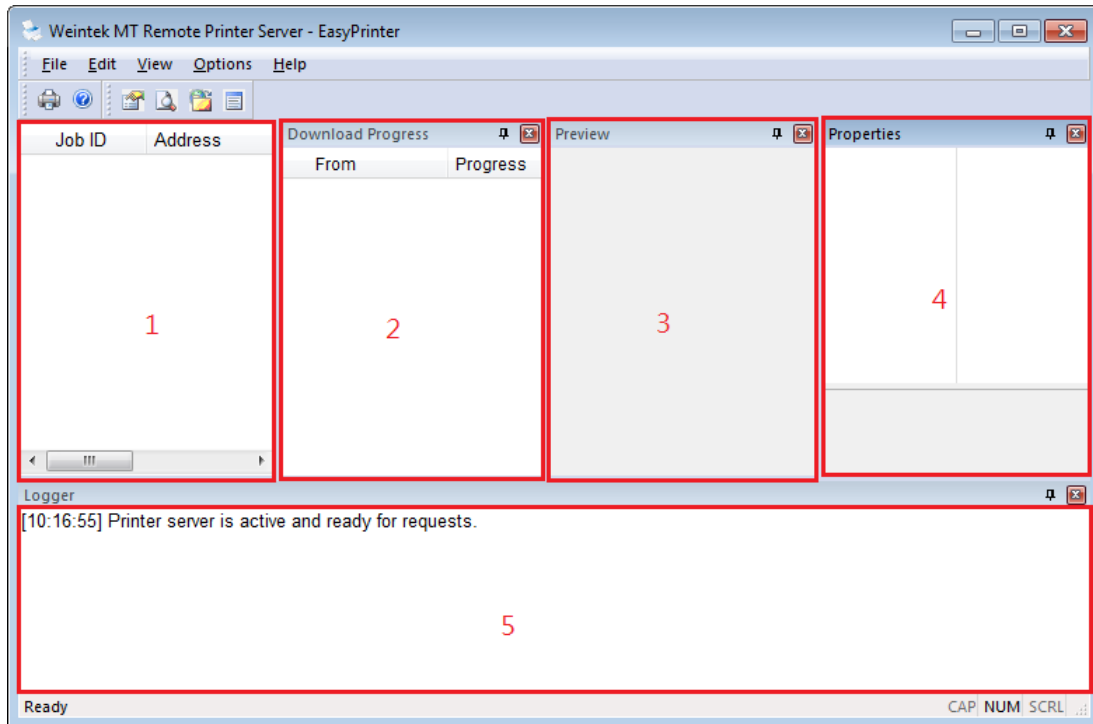

Area	Name	Description
1	Job List	Lists all incoming tasks, such as screen hardcopy and backup requests.
2	Download Progress	Shows the download progress of incoming requests.
3	Preview	Shows the preview image of the screen hardcopy task selected from [Job List].
4	Properties	Shows the information about the task selected from [Job List].
5	Logger	Shows the time and message information of events such as incoming request, incorrect password, etc.

26.4.2. Operation Guide

The following describes the function of EasyPrinter menu items.

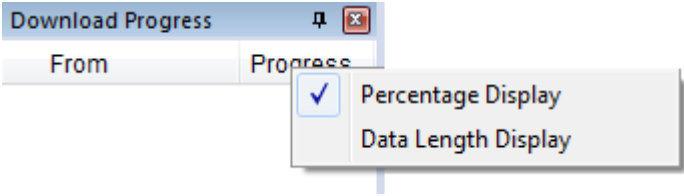
Menu	Description
File	<p>Enable Output</p> <p>If selected, EasyPrinter processes the tasks one by one, otherwise, EasyPrinter stores the tasks in memory.</p>
Edit	<p>Edit</p> <p>Edits screen hardcopy by setting [Orientation], [Scaling] and [Margins].</p> <p>Delete</p> <p>Deletes the selected tasks permanently.</p> <p>Select All</p> <p>Selects all tasks from [Job List].</p>
View	<p>Properties Bar</p> <p>Shows or hide the Property Window.</p> <p>Preview Bar</p> <p>Shows or hide the Preview Window.</p> <p>Download Bar</p> <p>In [Download Progress] Window, the mode to display download progress can be set by clicking the header of the [progress] column as shown in the following figure:</p>  <p>Logger Bar</p> <p>EasyPrinter can reserve up to 10,000 messages in Message Window. If a new message comes in, the oldest message will be deleted.</p>
Options	Please see the following page.

Note

- EasyPrinter can only reserve up to 128 MB of task data in memory. If the memory is full, any request coming in afterwards will be rejected. Users must either operate [Enable Output] or delete some tasks to make room for new tasks.

- The backup task is not editable.
- [Edit] is available only when a task is selected.
- [Delete] is available when at least one task is selected.

The following is the detail for [Options] » [Settings]

- In General Tab:

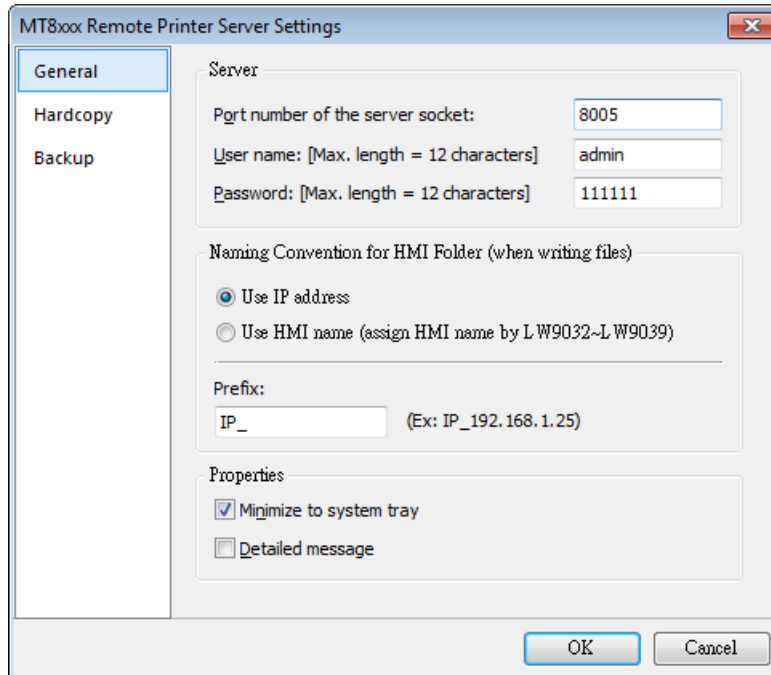

Setting	Description
Server	<p>Port number of the server socket Sets the Ethernet port number to connect the HMI. Range: 1 ~ 65535. Default: 8005.</p> <p>User name / Password Sets the user name and password to let only authorized HMIs send requests to EasyPrinter.</p>
Naming Convention for HMI Folder	<p>EasyPrinter uses different folders to store files (e.g. hardcopy bitmap files, backup files) from different HMI. There are two ways to name the folders:</p> <p>Use IP address EasyPrinter names the folder as [Prefix] + [IP address] after the HMI at this IP address sends request.</p>

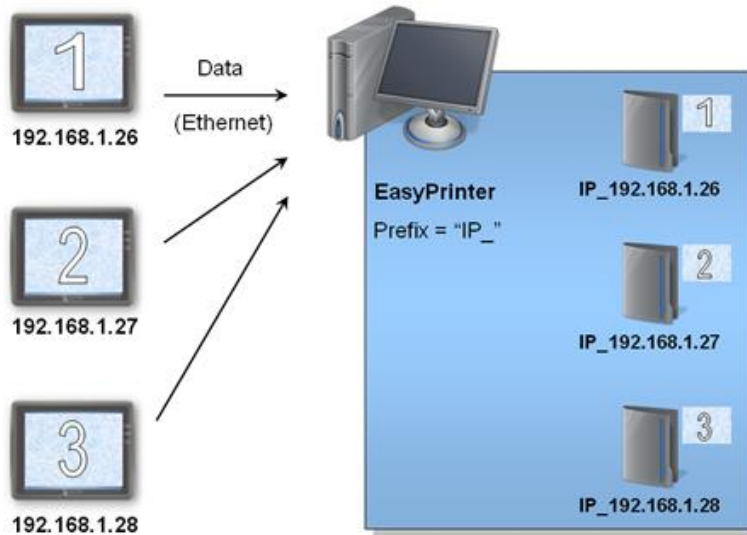

Use HMI name

EasyPrinter names the folder in [Prefix] + [HMI name] after the HMI this name indicates sends request.

Properties

Minimize to system tray

If this check box is selected, the EasyPrinter shortcut icon will be placed in the system tray in PC. Double click the on icon in system tray to open EasyPrinter.

Detailed message

Select this check box to display more detailed messages about events in the message window.

- In Hardcopy Tab:

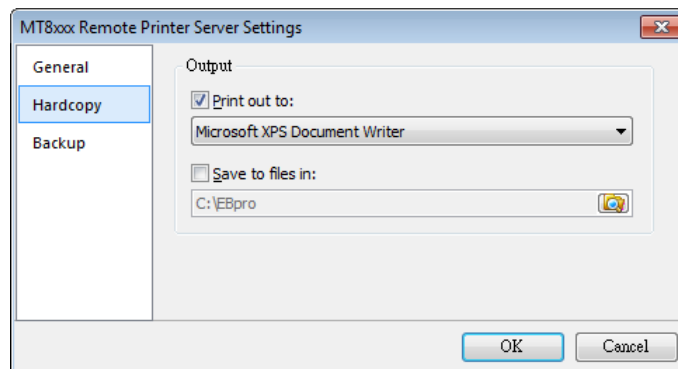

Setting	Description
Output	<p>Print out to EasyPrinter prints out the hardcopy result with the specified printers.</p> <p>Save to files in EasyPrinter converts the hardcopy result into a bitmap file and</p>

saves it in the specified directory. The bitmap files are found at:
 [Specified Path] \ [HMI Folder] \ yymmdd_hhmm.bmp
 For example, when a hardcopy request is given at 17:35:00,
 12/Jan/2009, the bitmap file will be named "090112_1735.bmp".
 And if there is another bitmap file generated within the same
 minute, it will be named "090112_1735_01.bmp" and so on.

- In Backup Tab:

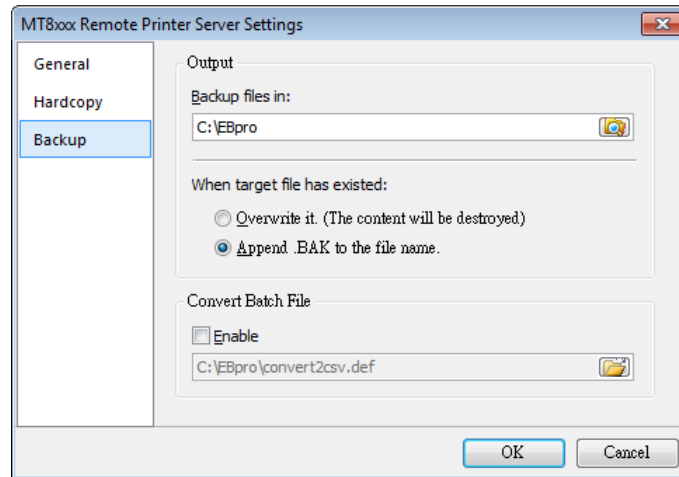

Setting	Description
Output	<p>Backup files in: EasyPrinter stores the backup files to the specified path. The upper directory is the same: [Specified Path] \ [HMI Name] or [IP address] The lower directory:</p> <ul style="list-style-type: none"> ● For Event Log files: \ eventlog\ EL_yyyymmdd.evt ● For Data Sampling files: \ datalog \ [File name of the Data Sampling] \ yyyymmdd.dtl ● For Recipe files: \ recipe \ recipe.rcp or recipe_a.rcp ● For Recipe Database: \ recipe \ recipe.db ● For Operation Log: \ operationlog\ operationlog.db
Convert Batch File	Select [Enable] to convert the selected history file to .csv or .xls (Excel) format of Convert Batch Files.

 **Note**

- System registers LW-9032 to LW-9039 can be used to specify HMI name.
- When closing EasyPrinter, the following dialog will appear.

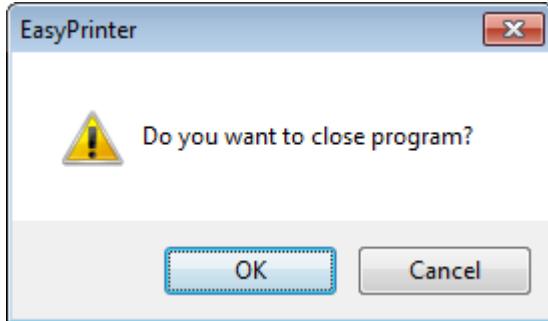

26.5. Convert Batch File

EasyPrinter provides a conversion tool to convert the uploaded Data Sampling and Event Log history files to .csv files automatically. To do so, please select [Enable] under [Convert Batch File] to make EasyPrinter convert the history files.

In the following illustration, the conversion is actually executed by EasyConverter. EasyPrinter simply follows the criteria in Convert Batch File and activates EasyConverter with proper arguments to achieve the conversion.

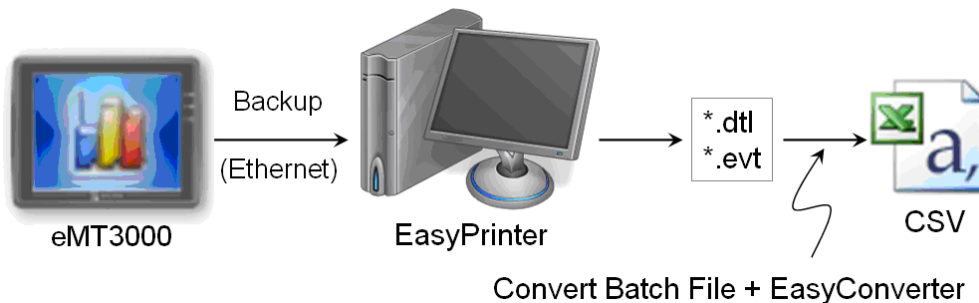

 **Note**

- EasyConverter is another Win32 application that converts history data into .csv or MS Excel .xls files. Users can find it in the EasyBuilder Pro installation directory.
- Users requesting this function must ensure EasyPrinter and EasyConverter are placed in the same directory.

26.5.1. The Default Value of Convert Batch File

The following is the default Convert Batch File: convert2csv.def

Listing 1. Default Convert Batch File

```
1: ".dtl", "EasyConverter /c $( Pathname)"
```

```
2: "evt", "EasyConverter /c $( Pathname)"
```

There are two lines in the file. Each line has two arguments separated by a comma and forms a criterion of how to process a specific type of files. The first argument stands for the extension name of the file type to be processed. The second argument stands for the command to be executed in console mode. Please note that “\$(Pathname)” is a key word to inform EasyPrinter to replace it with the real name of the converted backup file. For example, if a Data Sampling history file named 20090112.dtl is uploaded and stored, EasyPrinter will send out the following command to a console window:

```
1: EasyConverter /c 20090112.dtl
```

A file named 20090112.csv is created.

The criteria of the default Convert Batch File:

1. Convert all Data Sampling history files (.dtl) into .csv files.
2. Convert all Event Log history files (.evt) into .csv files.



Note

- “\$(Pathname)” in the second argument stands for the full path name of the file. In the previous case, EasyPrinter replaces it with:
[Specified Path] \ [HMI Folder] \ [datalog] \ [Folder name of the Data-Sampling object] \ 20090112.dtl
- EasyPrinter interprets the Convert Batch File in line basis, that is, each line forms a criterion.
- Any two arguments should be separated by a comma.
- Every argument should be put in double quotes.
- Do not put any comma inside an argument.
- Supported parameters for batch file: \$(PathName), \$(HmiName), and \$(IP) which stand for file path, HMI name, and HMI IP address.



For more information, see “25 Easy Converter”.

26.5.2. Specialized Criteria

The specialized criterion are needed when:

- Upload file to a specific HMI, see listing 2.
- Identify the HMI by HMI name, see listing 3.
- Process differently to different Data Sampling, see listing 4.

(This can only be used for Data Sampling file with the file name “voltage”.)

The 3rd argument (“*”) indicates this criterion accepts the Data Sampling files that meet the criterion from any HMI. Users can also change the 3rd argument to “192.168.1.26”,

“192.168.1.*”, or HMI name, etc. for narrowing the range of the target HMI.

Listing 2. Specialized Criterion for the HMI IP: 192.168.1.26

```
1: "dtl", "EasyConverter /c $(Pathname)", "192.168.1.26"
```

Listing 3. Specialized Criterion for HMI name: Weintek_01

```
1: "dtl", "EasyConverter /c $(Pathname)", "Weintek_01"
```

Listing 4. Specialized Creterion for Data Sampling file name: Voltage

```
1: "dtl", "EasyConverter /s Voltage.lgs $(Pathname)", "*", "Voltage"
```

26.5.3. The Format of a Convert Batch File

The following explains the arguments in a criterion.

File Type	Command (line)	HMI IP / Name	Condition 1	Condition 2
-----------	----------------	---------------	-------------	-------------

- File Type

This argument specifies the extension name of the uploaded file in this criterion. (e.g. “.dtl” for Data Sampling history files, “.evt” for Event Log history files)

- Command (line)

The command EasyPrinter sends to a console window if the uploaded file meets the criterion.

- HMI IP / Name

This argument specifies the HMI that meets the criterion.

- Condition 1

This argument specifies the folder name of the Data Sampling files that meet the criterion. This is not effective to other format of files.

- Condition 2

Not used (Reserved for future use).

26.5.4. The Order of Examining Criterion

EasyPrinter examines criterion in descending order every time a file is uploaded. Once the file meets a criterion, it stops the examination and starts over for the next file. Therefore, users should place the criterion with a wider range downward in the Convert Batch File and place the more specific criteria upward. For example:

```
"evt", "EasyConverter /c $(Pathname)"
```

```
"dtl", "EasyConverter /c $(Pathname)"
```

```
"dtl", "EasyConverter /c $(Pathname)", "192.168.1.26"
```

```
"dtl", "EasyConverter /c $(Pathname)", "my_HMI_01"
```

```
"dtl", "EasyConverter /c $(Pathname)", "my_HMI_02"
```

```
"dtl", "EasyConverter /s Voltage.lgs $(Pathname)", "*", "Voltage"
```

The correct order of examination would be: (from bottom to top)

```
"dtl", "EasyConverter /s Voltage.lgs $(Pathname)", "*", "Voltage"
```

```
"dtl", "EasyConverter /c $(Pathname)", "my_HMI_02"
```

```
"dtl", "EasyConverter /c $(Pathname)", "my_HMI_01"
```

```
"dtl", "EasyConverter /c $(Pathname)", "192.168.1.26"
```

```
"dtl", "EasyConverter /c $(Pathname)"
```

```
"evt", "EasyConverter /c $(Pathname)"
```

27. EasySimulator

This chapter explains how to use EasySimulator.

27.1. Overview.....	27-2
27.2. Steps to setup EasySimulator	27-2

27.1. Overview

EasySimulator allows a project to be run in the On- or Off-line simulator without having to start the simulator from EasyBuilder Pro. To do this, please prepare the required files and follow the steps to setup EasySimulator.

27.2. Steps to setup EasySimulator

1. Prepare the following required files.
 - [driver] → [win32]
 - com_e30.exe
 - EasySimulator.exe
 - gui_e30.exe
 - sqlite3.dll
 - xob_pos.def
2. Open **xob_pos.def** by using a text editing tool (e.g. Notepad) and edit the contents.

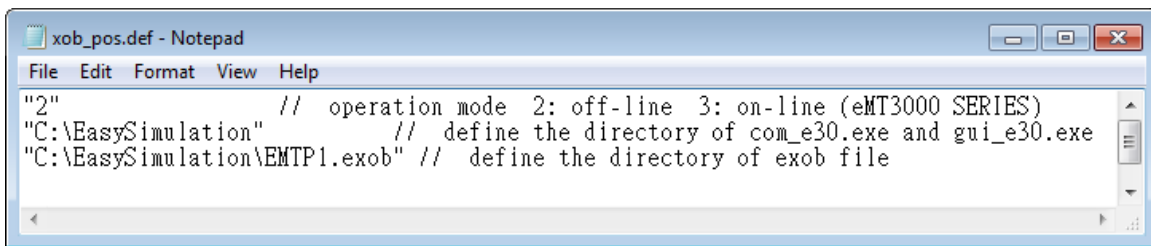

```

"2" // operation mode 2: off-line 3: on-line (eMT3000 SERIES)
"C:\EasySimulation" // define the directory of com_e30.exe and gui_e30.exe
"C:\EasySimulation\EMTP1.exob" // define the directory of exob file
  
```

Line number	Description
1	"2" run an Off-line Simulation; "3" run an On-line Simulation.
2	The directories of the relevant files. (e.g. com_e30.exe, gui_e30.exe, EasySimulator.exe...etc.)
3	The full path of the .exob file.

3. Double click on EasySimulator.exe to start a simulation.
4. On-line / Off-line Simulation is displayed on the screen.

Note

- The required files can be found in the EasyBuilder Pro installation directory. Please install EasyBuilder Pro first then copy the required files to your PC.
- If EasySimulator.exe is not activated, please check if the installation directory is correct.
- If the "Failed to open project file: No such file or directory" dialog box appears, this indicates that there is an error of the .exob file path, please check again.

28. Multi-HMI Communication (Master Slave Mode)

This chapter explains how to connect multiple HMIs.

28.1. Overview.....	28-2
28.2. Steps to Create a Project of Master HMI.....	28-2
28.3. Steps to Create a Project of Slave HMI	28-3
28.4. Steps to Connect with MT500 Slave HMI	28-5

28.1. Overview

Multi-HMI Communication means that a HMI connects with a remote HMI via COM port, and read the data in the PLC connected to the remote HMI as shown in the following figure.



The PLC is connected with HMI 1, and HMI 1 is connected with HMI 2 via COM port, so that HMI 2 can read the data in PLC through HMI 1.

The following parts explain how to create the projects used in HMI 1 and HMI 2 by using EasyBuilder Pro.

28.2. Steps to Create a Project of Master HMI

The following is the settings of HMI 1 in [System Parameter Settings] » [Device List].

Device list :

No.	Name	Location	Device type	Interface
Local HMI	Local HMI	Local	eMT/MT SERIES	-
Local PLC 1	FATEK FB Series	Local	FATEK FB Series	COM 1 (9600,E,...
▶ Local Server	Master-Slave S...	Local	Master-Slave S...	COM 3 (115200,...

1. Since COM 1 of HMI 1 connects to PLC; the device list must include [Local PLC 1], and set the correct parameters. In this example the connected PLC is “FATEK FB Series”.
2. COM 3 of HMI 1 is used to receive commands from HMI 2; a new device must be added—[Master-Slave Server] for setting communication properties of COM 3.

The parameters of COM 3 in the example are set to “115200, E, 8, 1”, and uses RS232.

These parameters are not required to be the same as PLC settings, but the [Data bits] must be set to 8. In general, a higher baud rate is recommended for HMI 2 to efficiently read PLC data.

28.3. Steps to Create a Project of Slave HMI

The following is the settings of HMI 2 in [System Parameter Settings] » [Device List].

Device list :

No.	Name	Location	Device type	Interface
Local HMI	Local HMI	Local	eMT/MT SERIES	-
▶ *Remote PL...	FATEK FB Series	COM 1 (...)	FATEK FB Series	COM 1 (115200,...

Since the PLC that HMI 2 reads is connected with HMI 1, thus for HMI 2, PLC is a remote device. Therefore, it is necessary to add a [Remote PLC] into the device list. In this example the connected PLC is “FATEK FB Series”. The way to create [*Remote PLC 1] is described in the following steps.

1. Add a new device. Set [PLC type] to [FATEK FB Series] and [PLC default station no.] must be set in accordance with the connected PLC.

The screenshot shows the 'Device Properties' dialog box for a FATEK FB Series PLC. The 'Name' field is set to 'FATEK FB Series'. The 'Location' is set to 'Local'. The 'PLC type' is set to 'FATEK FB Series'. The 'PLC I/F' is set to 'RS-232'. The 'COM' port is set to 'COM1 (9600,E,7,1)'. The 'PLC default station no.' is set to '1'. There are checkboxes for 'Default station no. use station no. variable' and 'Use broadcast command'. At the bottom, there are fields for 'Interval of block pack (words)' set to '5', 'Max. read-command size (words)' set to '64', and 'Max. write-command size (words)' set to '64'. The dialog has 'OK' and 'Cancel' buttons.

2. Correctly set the parameters. Since COM 1 of HMI 2 connects with COM 3 of HMI 1 instead of directly connect with PLC, the settings of PLC will be ignored. HMI 2 COM 1 and HMI 1 COM 3 must set to the same communication parameters and interfaces. As shown in the following figure, use RS232, and set parameters to [115200, E, 8, 1].

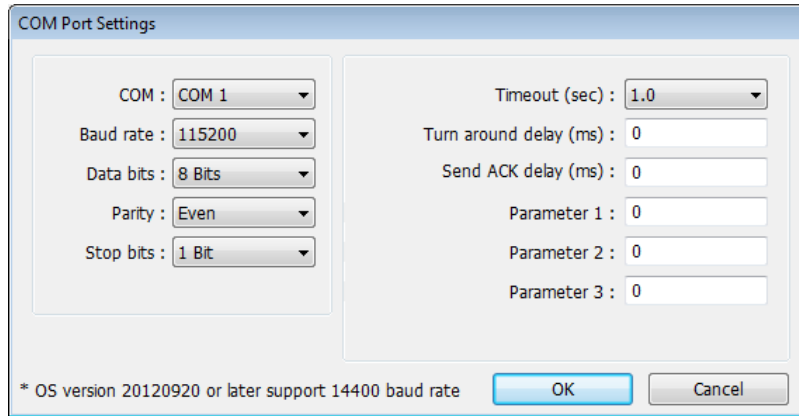

- For HMI 2, PLC is a remote device, change [Location] to [Remote], and select [COM port] to connect remote HMI (HMI 1).

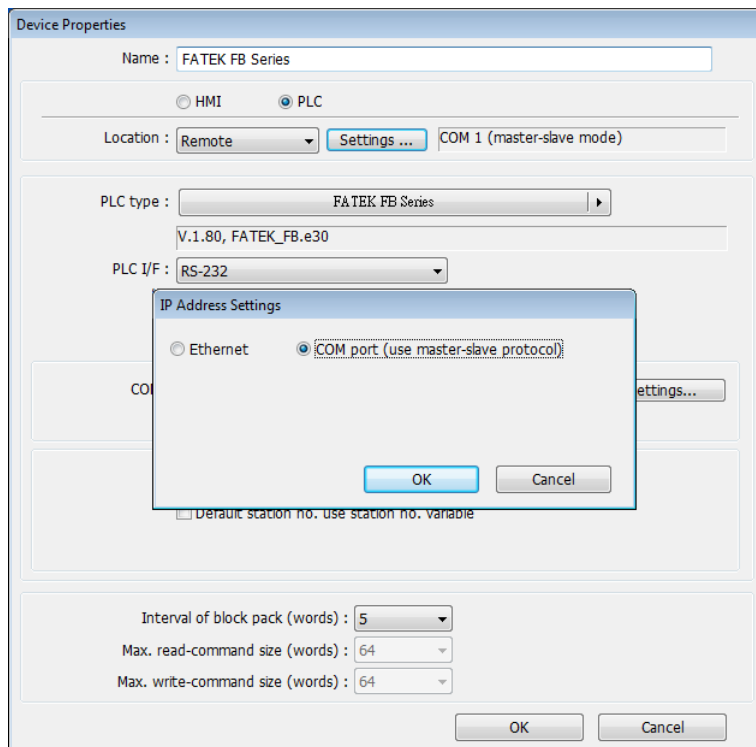

Device list :

No.	Name	Location	Device type	Interface	
	Local HMI	Local	eMT/MT SERIES	-	
▶	*Remote PL...	FATEK FB Series	COM 1 (...)	FATEK FB Series	COM 1 (115200,E...

- When finished, a new device [Remote PLC] can be found in the [Device List]. This device has a "*" symbol, which means, even if it contains "Remote" in the name, it actually gives commands and gets replies through a local COM port, and therefore the connection with PLC can be checked from a local system register. [*Remote PLC 1], [*Remote PLC 2], [*Remote PLC 3] and [Local PLC 1], [Local PLC 2], [Local PLC 3] use the same system registers from the listed below.

Register	Description
LB-9150	When ON, automatically connects with PLC (COM 1) when disconnected. When OFF, ignores disconnection with PLC.
LB-9151	When ON, automatically connects with PLC (COM 2) when disconnected. When OFF, ignores disconnection with PLC.
LB-9152	When ON, automatically connects with PLC (COM 3) when disconnected. When OFF, ignores disconnection with PLC.
LB-9200~ LB-9455	These local registers indicate the connection states with PLC (through COM1). LB9200 indicates the connection state with PLC (station no. 0), and LB9201 indicates the connection state with PLC (station no. 1) and so on. When ON, indicates the connection state is normal. When OFF, indicates disconnection with PLC. Set ON again, the system will then try to connect with PLC.
LB-9500~ LB-9755	These local registers indicate the connection states with PLC (through COM2). LB9500 indicates the connection state with PLC (station no. 0), and LB9501 indicates the connection state with PLC (station no. 1) and so on. When ON, indicates the connection state is normal. When OFF, indicates disconnection with PLC. Set ON again, the system will then try to connect with PLC.
LB-9800~ LB-10055	These local registers indicate the connection states with PLC (through COM3). LB9800 indicates the connection state with PLC (station no. 0), and LB9801 indicates the connection state with PLC (station no. 1) and so on. When ON, indicates the connection state is normal. When OFF, indicates disconnection with PLC. Set ON again, the system will then try to connect with PLC.

28.4. Steps to Connect with MT500 Slave HMI

EasyBuilder Master-Slave Protocol enables MT500 to exchange data with eMT3000 local data via the connected PLC.

28.4.1. Settings in EasyBuilder Pro

1. Select [Master-Slave Server] and click [Settings]. If a PLC is connected, follow the original settings.

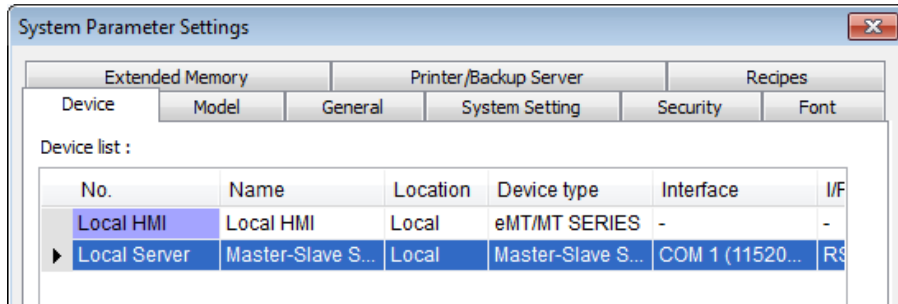

2. Select [RS-232], click [Settings].

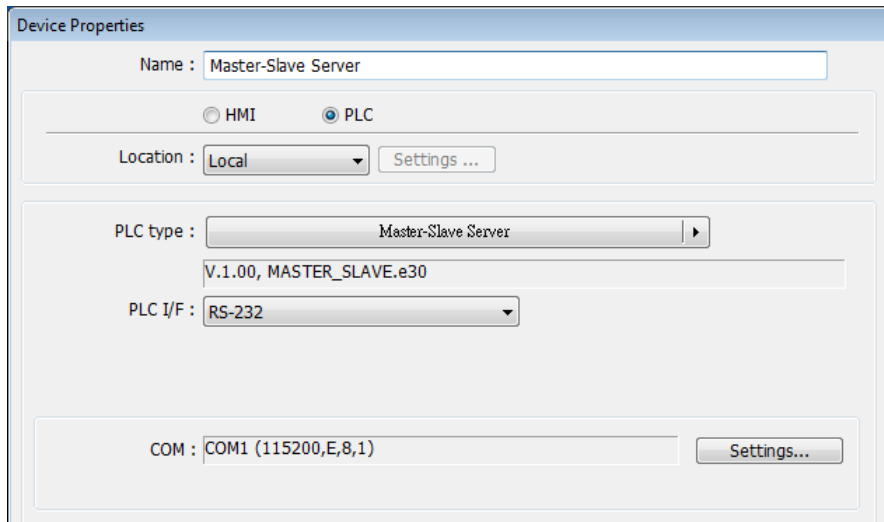

3. Fill in MT500 PLC ID No. in [Parameter 1] (Refer to MT500 settings).

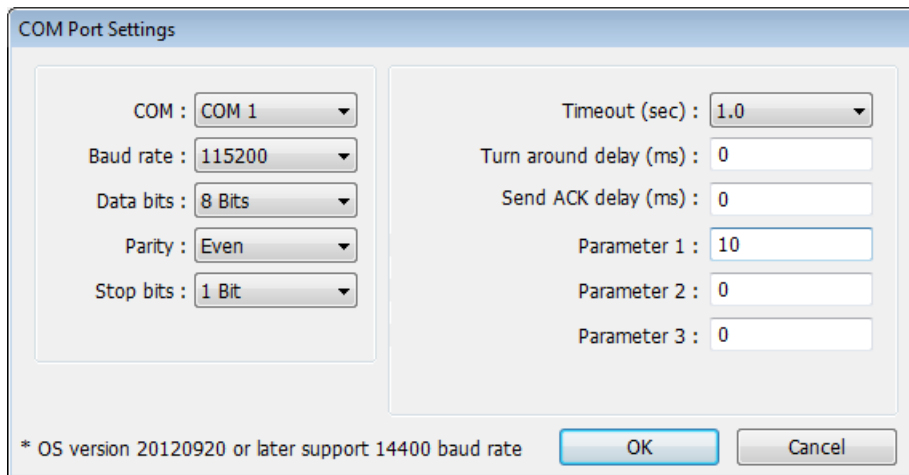

28.4.2. Settings in EasyBuilder500

1. In [System Parameter Settings], set [Multiple HMI] to Slave, set [HMI-HMI link speed] to 115200.

Note

- [Baud rate] must be identical in EasyBuilder500 and EasyBuilder Pro.

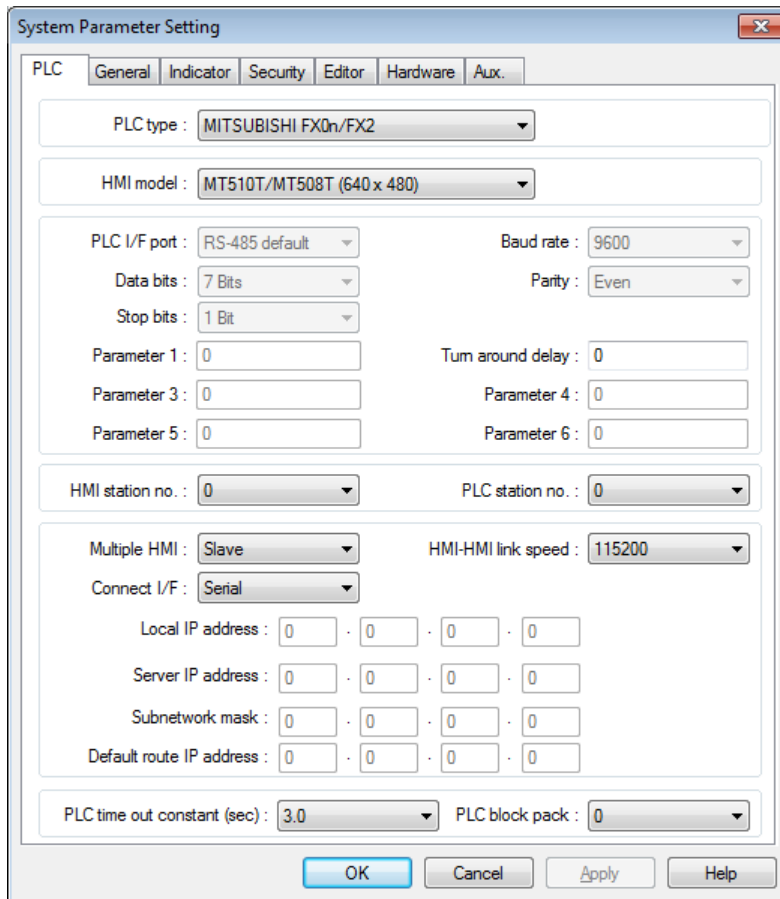

2. Double click PLC Address View.exe to check PLC ID No. and fill in [Parameter 1] of EasyBuilder.

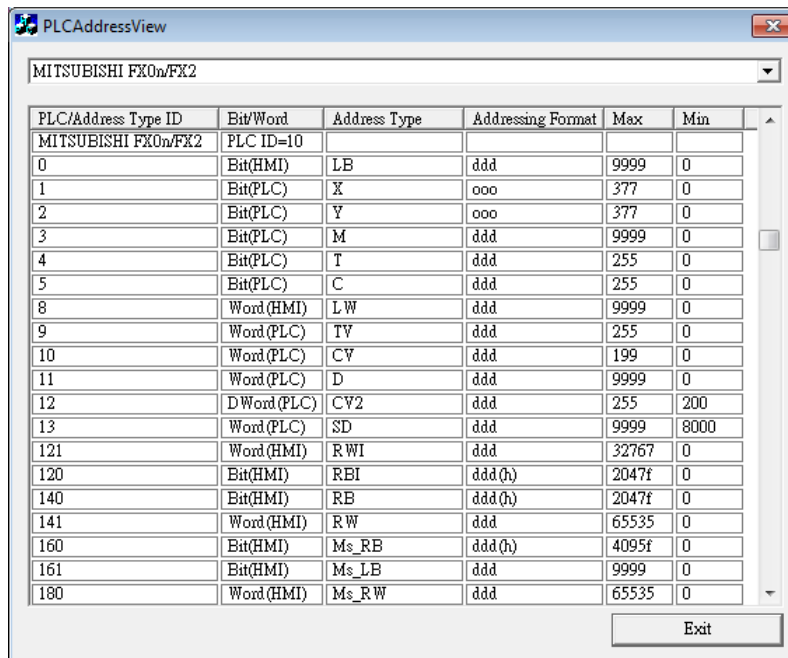

3. Connect HMIs via Com Port RS-232, the communication is then enabled.

 **Note**

- There will always be a PLC selected in MT500 system parameter settings, in this case, even to read/write eMT3000 local data, the ID of the selected PLC of MT500 system parameters must also be filled in EasyBuilder [Parameter 1].
- When using S7-200, S7-300 drivers, since MT500 reverses the high bytes and the low bytes, this will cause MT500 to misread eMT3000 local data, therefore this way is not available in Master-Slave Mode.

The Comparison between MT500 and eMT3000:

Bit/Word	MT500	eMT3000	Range
B	Ms_RB	RW_Bit	dddd: 0~4095 (h): 0~f
B	Ms_LB	LB	dddd: 0~9999
W	Ms_RW	RW	dddd: 0~65535
W	Ms_LW	LW	dddd: 0~9999

29. Pass-through

This chapter explains how to set up Pass-through mode.

29.1. Overview.....	29-2
29.2. Ethernet Mode	29-2
29.3. COM Port Mode.....	29-7
29.4. Pass-through Control	29-9
29.5. SIEMENS S7-200 PPI and S7-300 MPI Pass-through Settings	29-10

29.1. Overview

The Pass-through feature allows PC applications to control PLC via HMI. In this case the HMI is an adaptor.

The Pass-through feature provides two modes:

- Ethernet
- COM port

Click [Pass-through] in Utility Manager to open the setting dialog box.

29.2. Ethernet Mode

29.2.1. Steps to Install Virtual Serial Port Driver

Before using [Ethernet] mode, please check if Weintek virtual serial port driver has been installed.

1. Open Utility Manager to check if the driver has been installed. If it shows [Please install weintek virtual serial port driver], please click [Install].

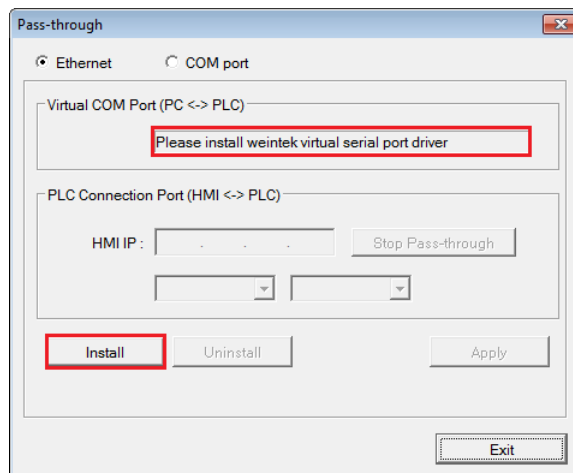

2. If the dialog below pops up during installation asking for verification, please click [Continue Anyway].

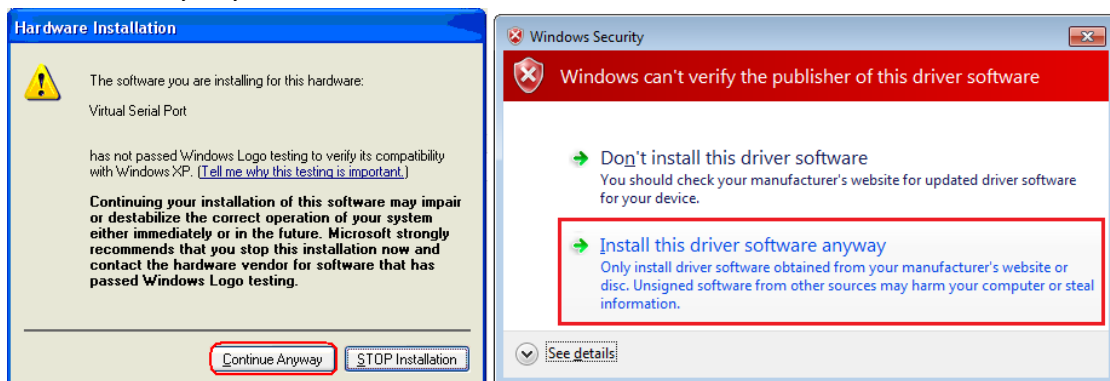

- When finished, the [Virtual COM Port (PC <-> PLC)] field displays the virtual COM port used.

29.2.2. Steps to Change the Virtual Serial Port Number

- Open [Device Manager] and find Virtual Serial Port.

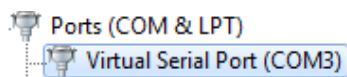

- To change to another COM Port Number, double-click Virtual Serial Port and open [Port Settings] » [Advanced].

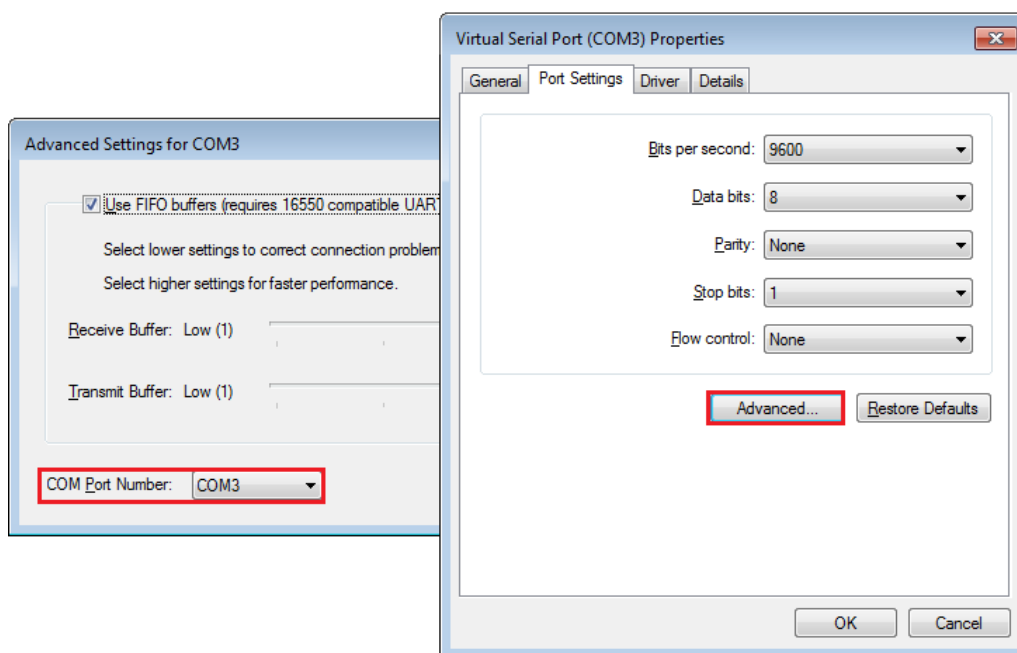

29.2.3. Steps to Uninstall the Virtual Serial Port

- Open [Device Manager] and find Virtual Serial Port.

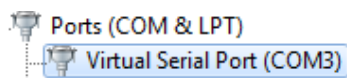

- To uninstall the Virtual Serial Port, select it and click the [Uninstall] button in the Device Manager toolbar.

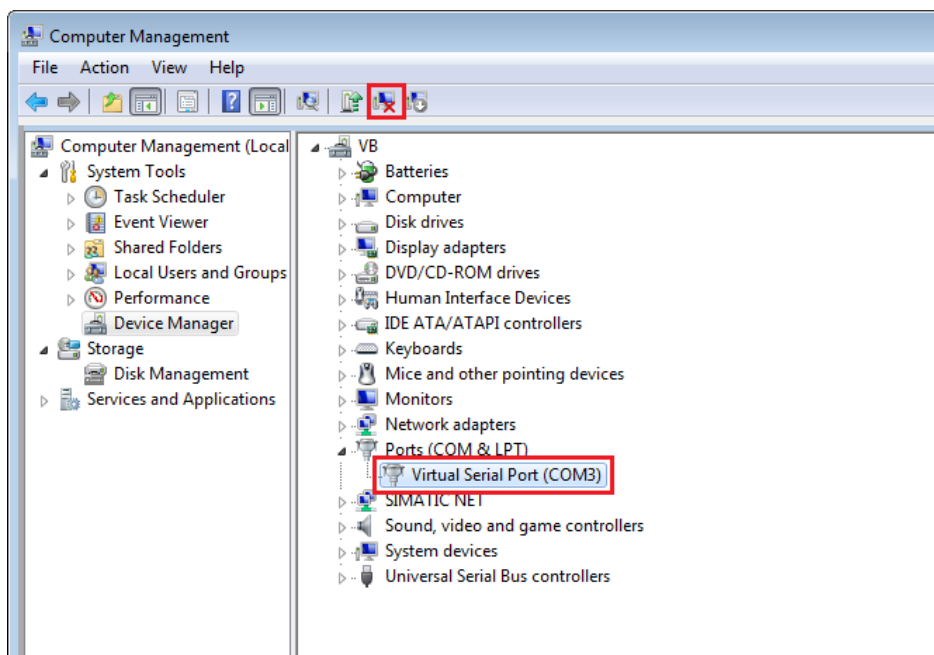

3. Click [OK] to uninstall this Virtual Serial Port.

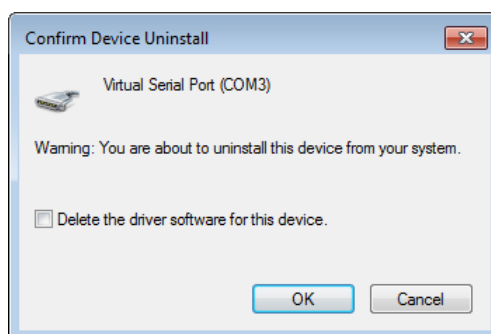

29.2.4. Steps to Update Virtual Serial Port Driver

1. Open [Device Manager] and find Virtual Serial Port.

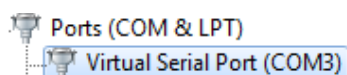

2. To update virtual serial port driver software, select Virtual Serial Port and click the [Update Driver Software] button in the Device Manager toolbar.

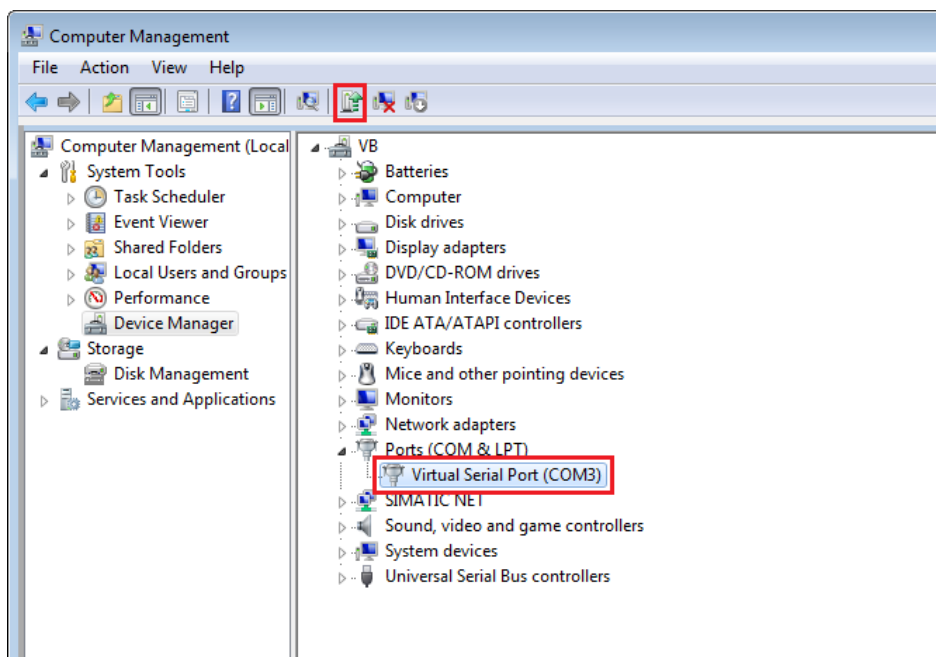

3. Browser for the directory of the driver, and then click [Next] to update the driver.

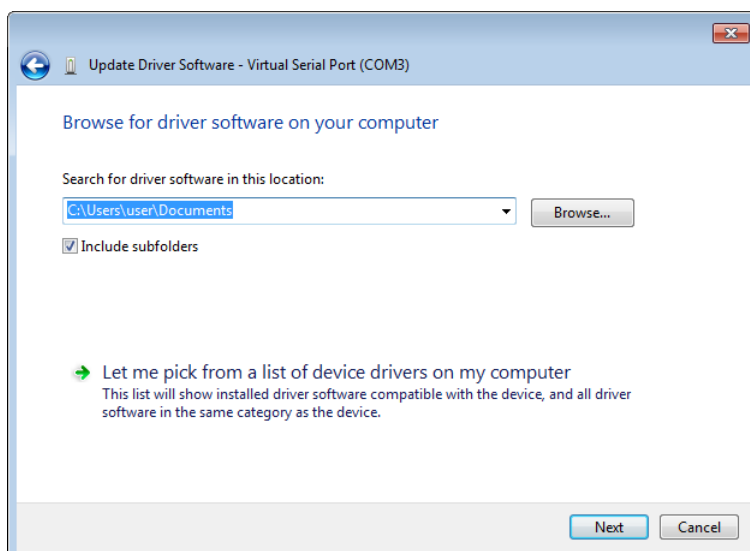

29.2.5. Settings of Ethernet mode

After installing the virtual serial port driver, follow the steps to use Ethernet mode of pass-through feature.

1. Set the IP address of the HMI connected with PLC.
2. Set the communication port and the serial port that connects HMI with PLC.
3. Click [Apply], to apply the settings.

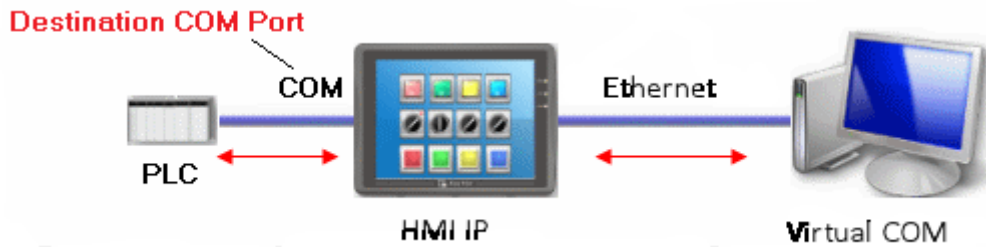
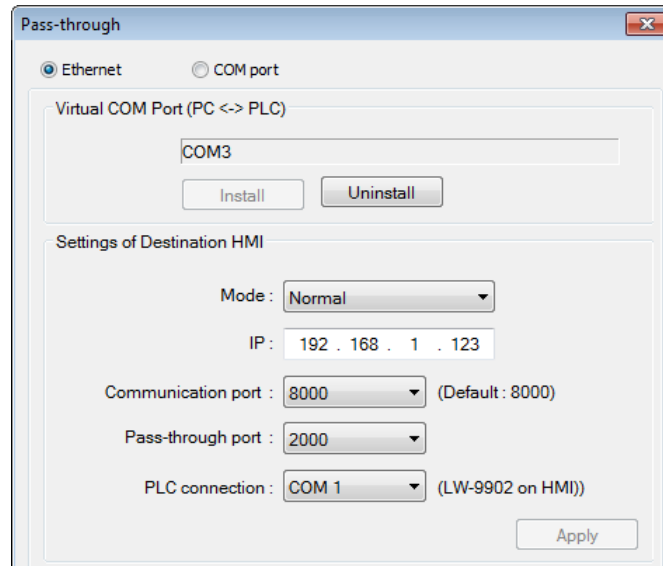

- When running PC application, set COM port to the used virtual serial port. For example, in Mitsubishi application, if the virtual serial port is COM 3, set [PC side I/F Serial setting] » [COM port] to COM 3.

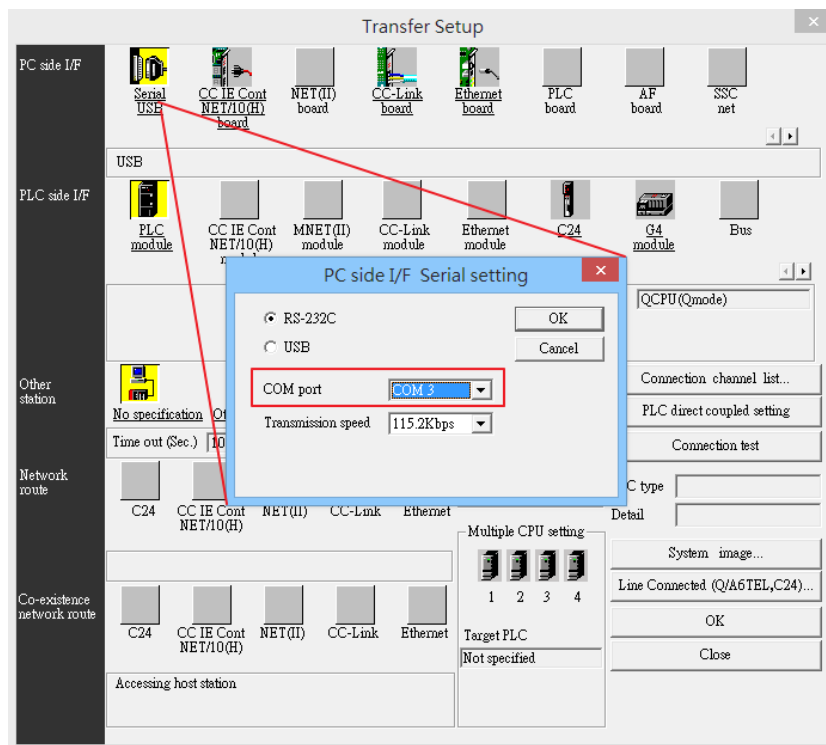

- With the correct configurations, upon execution of PLC application on PC, HMI will be

automatically switched to Pass-through mode. During Pass-through, the PLC is controlled by PC via the virtual serial port. Pass-through mode will be turned off when the application ends.

29.3. COM Port Mode

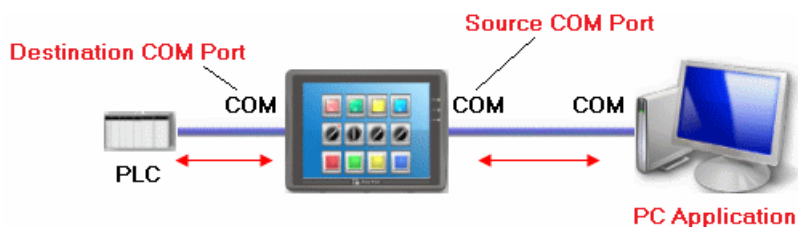

[Source COM Port] The port connects HMI with PC.

[Destination COM Port] The port connects HMI with PLC.

To use [COM port] mode of Pass-through, please set the properties of Source COM Port and Destination COM Port correctly.

29.3.1. Settings of COM Port Mode

There are two ways to enable [COM port] mode of Pass-through feature.

- Using Utility Manager.
- Using system registers.

LW-9901: pass-through source COM port (1 ~ 3: COM 1 ~ COM 3)

LW-9902: pass-through destination COM port (1 ~ 3: COM 1 ~ COM 3)

29.3.2. Using Utility Manager

1. Click [Pass-through] button in Utility Manager to set the communication parameters as shown in the following figure.

Setting	Description
HMI IP	HMI IP address.
Get HMI Communication Parameters	Reads the settings of Source and Destination COM port. Click this button to update the communication parameters.
Source COM Port (PC->HMI) / Destination COM Port (HMI->PLC)	The communication parameters of Source and Destination COM Port are displayed. The settings will be applied when [Start Pass-through] is clicked.
Baud rate / Data bits / Parity / Stop bits	Source and Destination COM Port parameters should be set to be same. Since [Source COM Port] connects PC, select RS-232 mode in most situations; [Destination COM Port] connects PLC, so the setting depends on the PLC type, and can be one of RS-232, RS-485 2W, or RS-485 4W.

Note

- When pass-through feature is no longer needed, click [Stop Pass-through] to stop it. HMI will then resume communication with PLC.

There are three work modes of HMI.

Mode	Description
Unknown	The work mode before reading the settings of HMI.
Normal	The work mode after reading the settings of HMI. The HMI does not accept any data form the Source COM Port.
Pass-through	The work mode is “Pass-through.” the PC connected via Source COM Port can control the PLC connected via Destination COM Port.

29.3.3. Using System Registers

Another way of enabling pass-through is by writing to LW-9901(Source COM port) and LW-9902 (Destination COM port).When the values of LW-9901 and LW-9902 match the conditions below, HMI will start Pass-through automatically:

- The values of LW-9901 and LW-9902 are 1 to 3 (1 to 3: COM 1 to COM 3).
- The values of LW-9901 and LW-9902 are different.

To change the communication parameters, just change the value in the related registers and set ON the appropriate registers: [LB-9030: update COM 1 communication parameters], [LB-9031: update COM 2 communication parameters] and [LB-9032: update COM 3 communication parameters]. HMI will then update the settings.

Note

- To stop Pass-through, change the values of LW-9901 and LW-9902 to 0.

29.4. Pass-through Control

Generally speaking, during pass-through, HMI closes its connection with the PLC until the pass-through mode ends. However, certain PLC drivers allow communications between HMI and PLC in pass-through mode.



To see whether a driver supports concurrent communication, see “PLC Connection Guide”.

Pass-through control is controlled by LW-9903. The following table shows valid LW-9903 values and their features.

LW-9903	Description
0 (Default)	Normal Mode. Communications between HMI and PLC in pass-through mode is allowed.
2	Stop Mode. No communications between HMI and PLC in pass-through mode

Note

- Due to speed limitation, users may wish to set LW-9903 to 2 to enhance the speed of program download/upload in pass-through mode.

29.5. SIEMENS S7-200 PPI and S7-300 MPI Pass-through Settings

EasyBuilder Pro supports SIEMENS S7-200 PPI and S7-300 MPI pass-through feature.

29.5.1. EasyBuilder Pro Settings

Launch EasyBuilder Pro, go to [System Parameter Settings] » [Device list], and then add SIEMENS S7-200 PPI or S7-300 MPI device. Click [Pass-Through Settings] and the following dialog box appears.

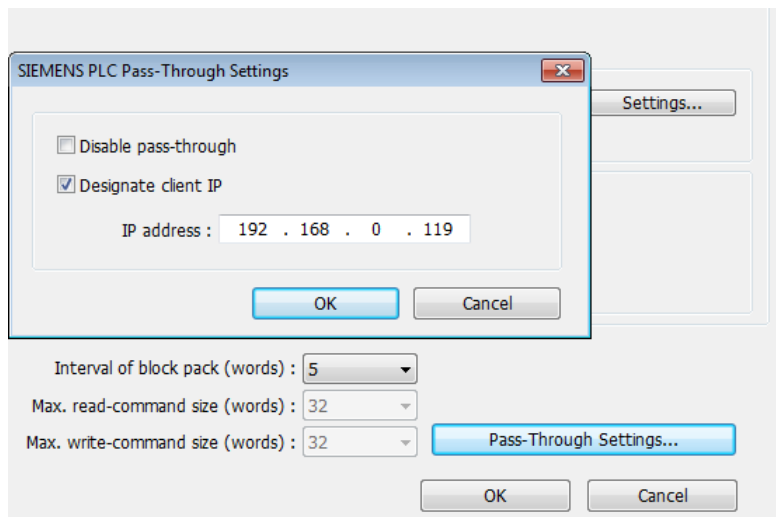

Setting	Description
Disable pass-through	Select this check box to disable pass-through mode. By default this check box is not selected.
Designate client IP	Designate client HMI IP address used in pass-through mode.

29.5.2. S7-200 PPI Connection

Confirm that the HMI used in pass-through communication is started and connected to the network. Launch STEP 7 Micro/Win, open [Communications] dialog box, and then search for the HMI IP address. Connect the HMI to communicate.

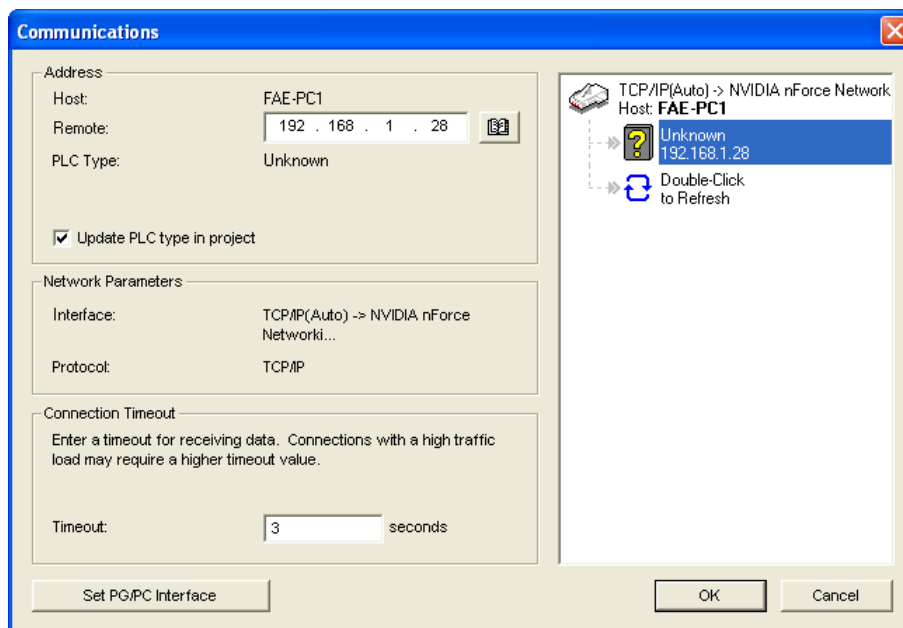

29.5.3. S7-300 MPI Connection

Connect via virtual COM port or Ethernet.

29.5.3.1. Virtual COM Port

1. In Utility Manager run [Pass-Through], in [HMI Mode] select “MPI ISOTCP” to install virtual serial port driver. Set the HMI IP address and the COM port that connects PLC, and then start Pass-through.

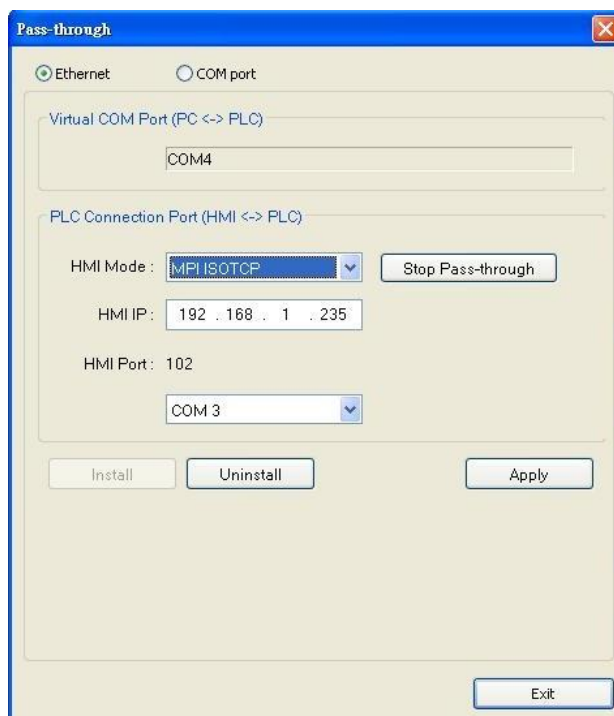

2. In STEP 7, go to [Option] » [Set PG/PC Interface]. Confirm that the interface used is “PC

Adapter(MPI)”, and then click [Properties]. Select the same COM port as the virtual serial port. In the example COM 4 is used.

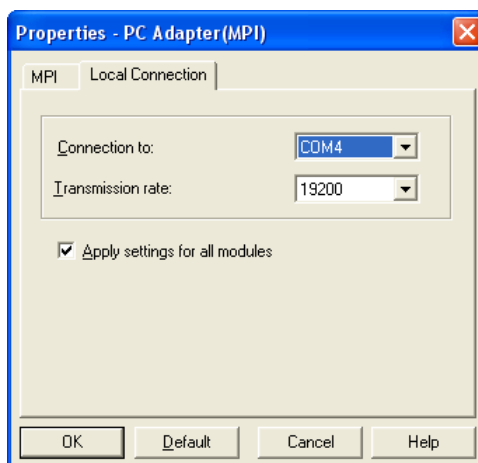
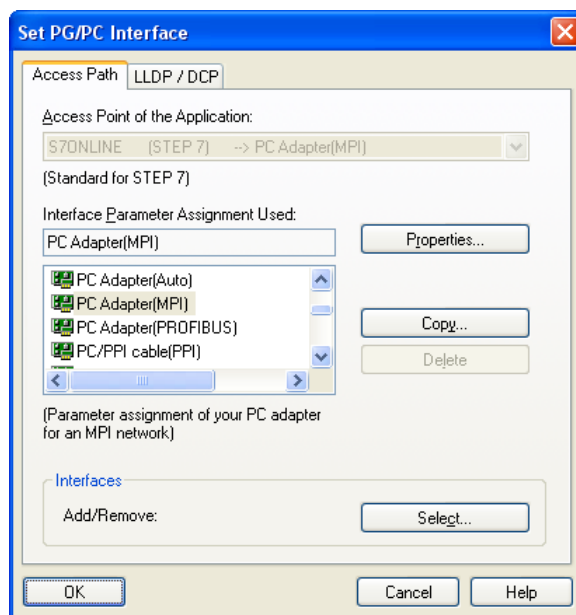

3. When finished, STEP 7 can be used to Upload / Download PLC program via HMI.

29.5.3.2. Ethernet

1. In STEP 7 go to [Option] » [Set PG/PC Interface]. As shown in the following figure, select “TCP/IP(Auto) -> the name of the network interface card”.

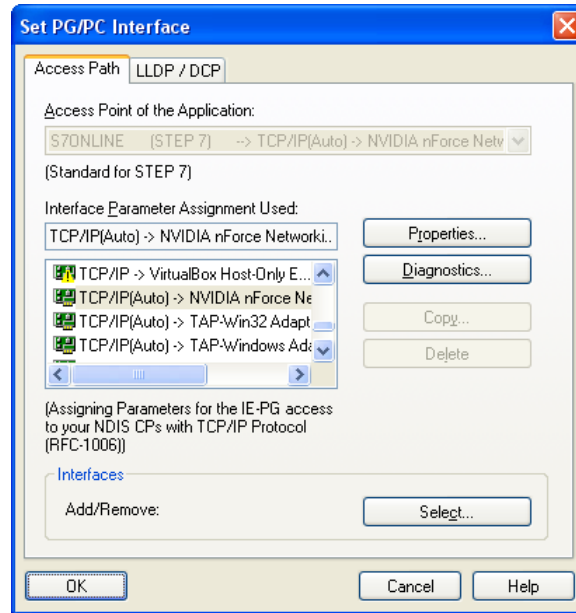

2. Go to [PLC] » [Update station to PG], in [Target Station] select [Can be reached by means of gateway]. From left to right columns enter MPI, PLC station number, S7 Subnet ID, and HMI IP address. When finished, S7 can upload PLC program to STEP 7 via HMI.

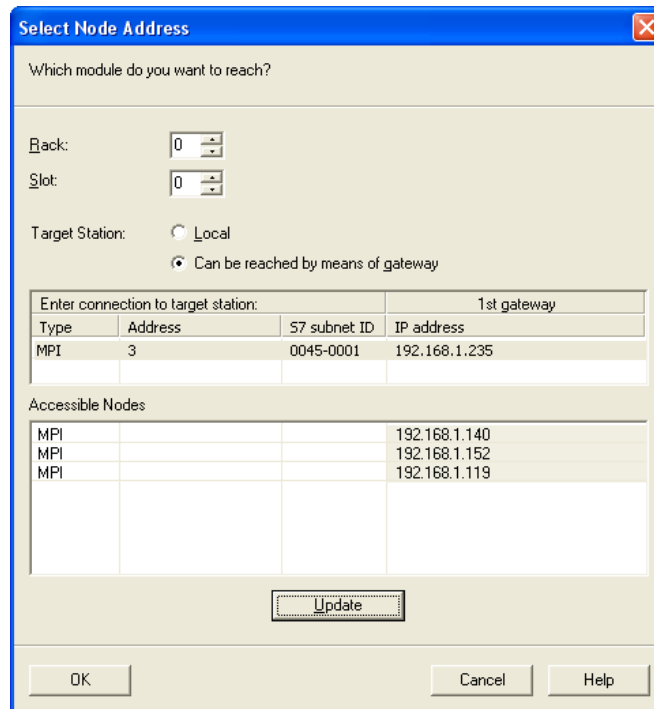

29.5.4. Registers of SIEMENS Pass-through

System registers from LW-10850 to LW-10864 are used to set or indicate pass-through status of SIEMENS devices.

 For more information see “22 System Registers”.

During pass-through mode, LW-10863 indicates errors and LW-10864 displays error code. The following table lists the error codes, the description of each code, and the possible reason.

(The client usually refers to STEP 7 PLC program)

Error Code	Description	Possible Reason
0	Successfully executed	
1	Prohibit client from connecting HMI	HMI is already running pass-through and won't accept any request from other client.
2	Prohibit client from connecting HMI	When LW-10850 is set to 1, the client IP for connecting HMI is different from the IP specified in LW-10858 ~ LW-10861.
3	Invalid communication protocol	Incorrect setting in LW-10853.
4	Invalid PLC station number	The PLC station number specified in LW-10852 does not exist.
5	Delayed communication	PLC connection failure.
6	Busy communication	PLC does not accept pass-through request, please confirm PLC settings.
7	Invalid pass-through request	Environment setup failure.

30. Project Protection

This chapter explains the settings relevant to project protection.

30.1. Overview	30-2
30.2. EXOB Password	30-2
30.3. Decompilation is Prohibited	30-3
30.4. Disable EXOB Upload Function	30-3
30.5. Project Key	30-3
30.6. EMTP Password	30-4

30.1. Overview

The copyright of program design must be protected. This chapter discusses how to protect the projects by settings in EasyBuilder Pro.

Note

- The protected projects cannot be decrypted by the factory since they are encrypted by users, therefore, please remember your password.

30.2. EXOB Password

After editing a project (.empt), users can compile the project to .exob format. The .exob file can be downloaded to HMI. Password can be set to protect the .exob file in [EXOB password] when compiling. (Password range: 0 ~ 4294967295)

A password will be required when attempting to decompile the .exob file back to .empt file. If the password is entered incorrectly for three times, please restart EasyBuilder Pro.

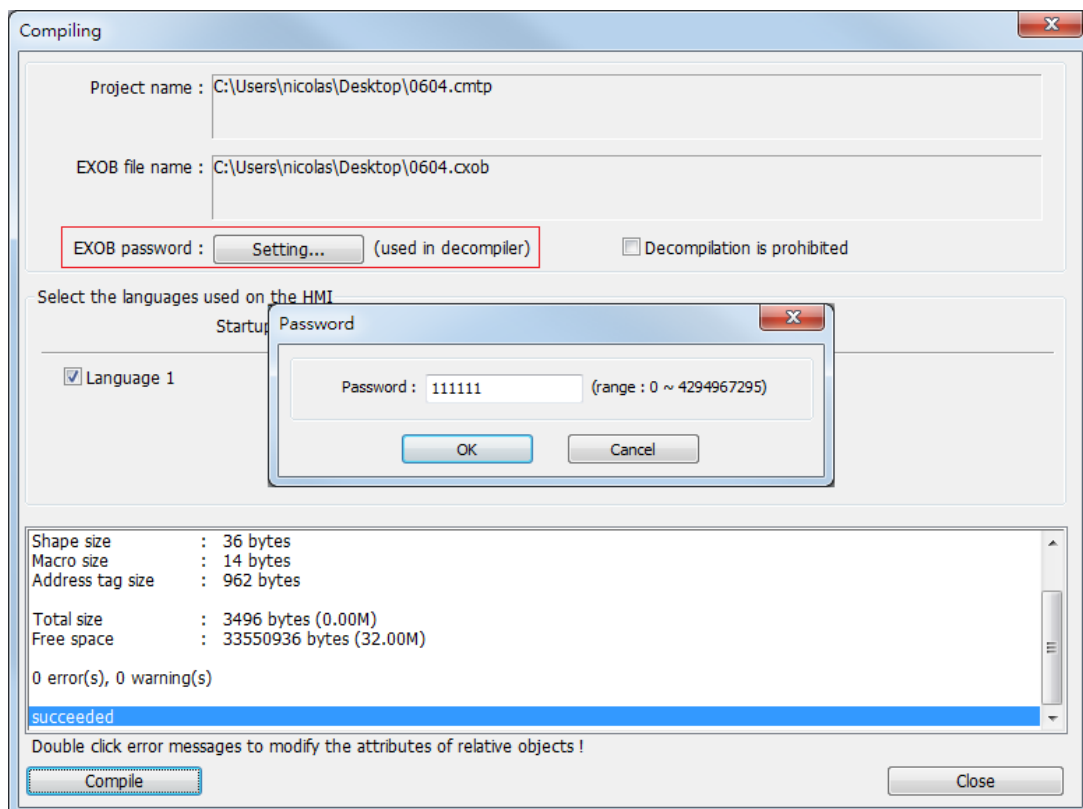

30.3. Decompilation is Prohibited

After a project (.emtp) is done editing, users can compile the project to .exob format. The .exob file can be downloaded to HMI. If [Decompilation is prohibited] check box is selected when compiling, the setting in [EXOB password] will be ignored. Furthermore, the .exob file cannot be decompiled to .emtp file.

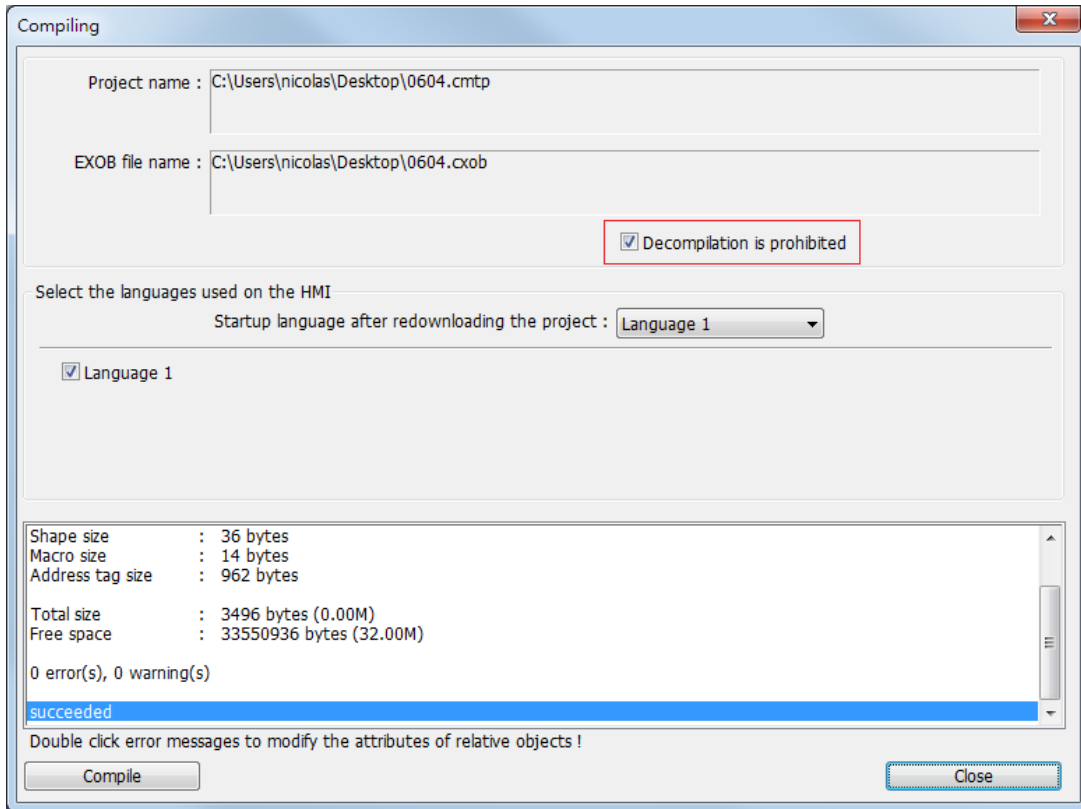

30.4. Disable EXOB Upload Function

EasyBuilder Pro provides a system reserved register [LB-9033]. When this register is set ON, the .exob file cannot be uploaded. If attempting to upload an .exob file with this register set ON, the file obtained after uploading is 0 byte, and cannot be decompiled. Please reboot HMI for the changed setting to take effect.

30.5. Project Key

Projects can be restricted to run on a specific HMI.

The setting is in [System Parameters Settings] » [General] » [Project protection].

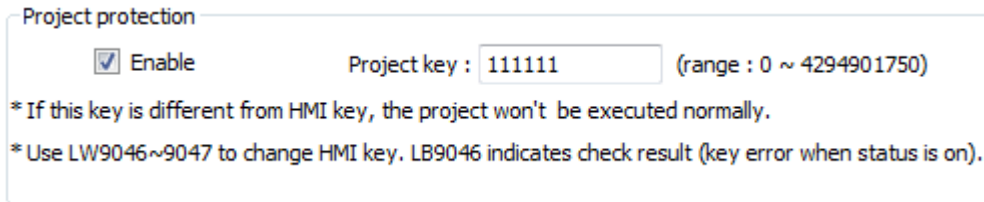

Project protection

Enable Project key : 111111 (range : 0 ~ 4294901750)

* If this key is different from HMI key, the project won't be executed normally.

* Use LW9046~9047 to change HMI key. LB9046 indicates check result (key error when status is on).

If the [Enable] check box is selected under [Project protection], please set the [Project key] (password range: 0 ~ 4294901750). System registers LW-9046 ~ LW-9047 (32-bit) can be used to set the [HMI key] for HMI. The values in LW-9046 and LW-9047 cannot be read or written by a remote device. The .exob file obtained after compiling can only be executed on HMI when [HMI key] and [Project key] match. If the keys don't match, LB-9046 is set ON. To change [HMI key], please reboot HMI.

Note

- When **[HMI key]** and **[Project key]** don't match, HMI and PLC cannot communicate.
-  Click the icon to download the demo project. Please confirm your internet connection.

30.6. EMTP Password

After a project (.emtp) is done editing, a password can be set to protect the .emtp file. In [System parameter] » [Security] tab, select [Enable] check box under [Project password] and click [Settings] (password range: 1 ~ 4294967295).

The password will be required when attempting to open the .emtp file.

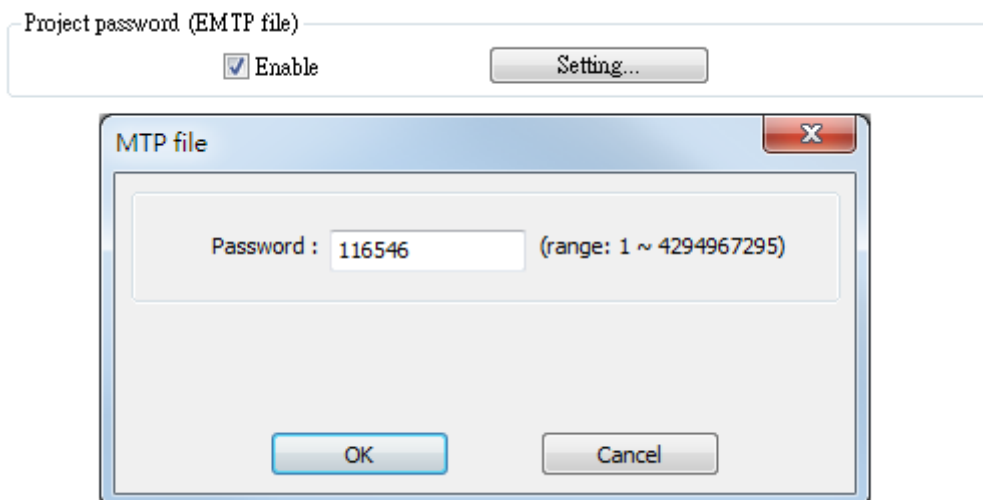

Project password (EMTP file)

Enable Setting...

MTP file

Password : 116546 (range: 1 ~ 4294967295)

OK Cancel

Note

- When using “Window Copy” function, if the source file is protected by EMTP password, please enter the correct password for the system to execute window copy.

31. Memory Map

This chapter explains the settings relevant to Memory Map.

31.1. Overview.....	31-2
31.2. PIN Settings.....	31-2
31.3. Communication Flowchart	31-3
31.4. Address Types	31-4
31.5. Settings	31-7

31.1. Overview

Memory Map communication protocol is similar to IBM 3764R, and it is used when the memory data transferred seldom between two devices. When setting the two devices, one is set as Master, and another is Slave. Generally, Master and Slave do not communicate unless the data in the assigned address has changed. Once the data is synchronized, the communication will stop. The purpose of Memory Map is to keep the consistency of the assigned part of data between two devices (Master and Slave).

The corresponding addresses of Master and Slave devices should have the same property as MW (MB) address type. The size of MW (MB) in HMI is 10,000 words.

MB and MW indicate the same area of memory, for example, MB0~MBf correspond to the bits of MW0, MB10~MB1f correspond to MW1, as shown in the following table:

Device Type	Format	Range
MB	DDDDh	DDDD:0~4095 h:0~f(hex)
MW	DDDD	DDDD:0~9999

31.2. PIN Settings

When using Memory Map communication protocol, the Master and Slave must have the same communication parameters. The wiring is shown in the following table:

(the # will be distinct depends on the type of PLC or controller.)

COM Port	RS-232	
Device	Master	Slave
Pin Mapping	TX(#)	RX(#)
	RX(#)	TX(#)
	GND(#)	GND(#)
COM Port	RS-485 (4W)	
Device	Master	Slave
Pin Mapping	TX+(#)	RX+(#)
	TX-(#)	RX-(#)
	RX+(#)	TX+(#)
	RX-(#)	TX-(#)
	GND(#)	GND(#)

31.3. Communication Flowchart

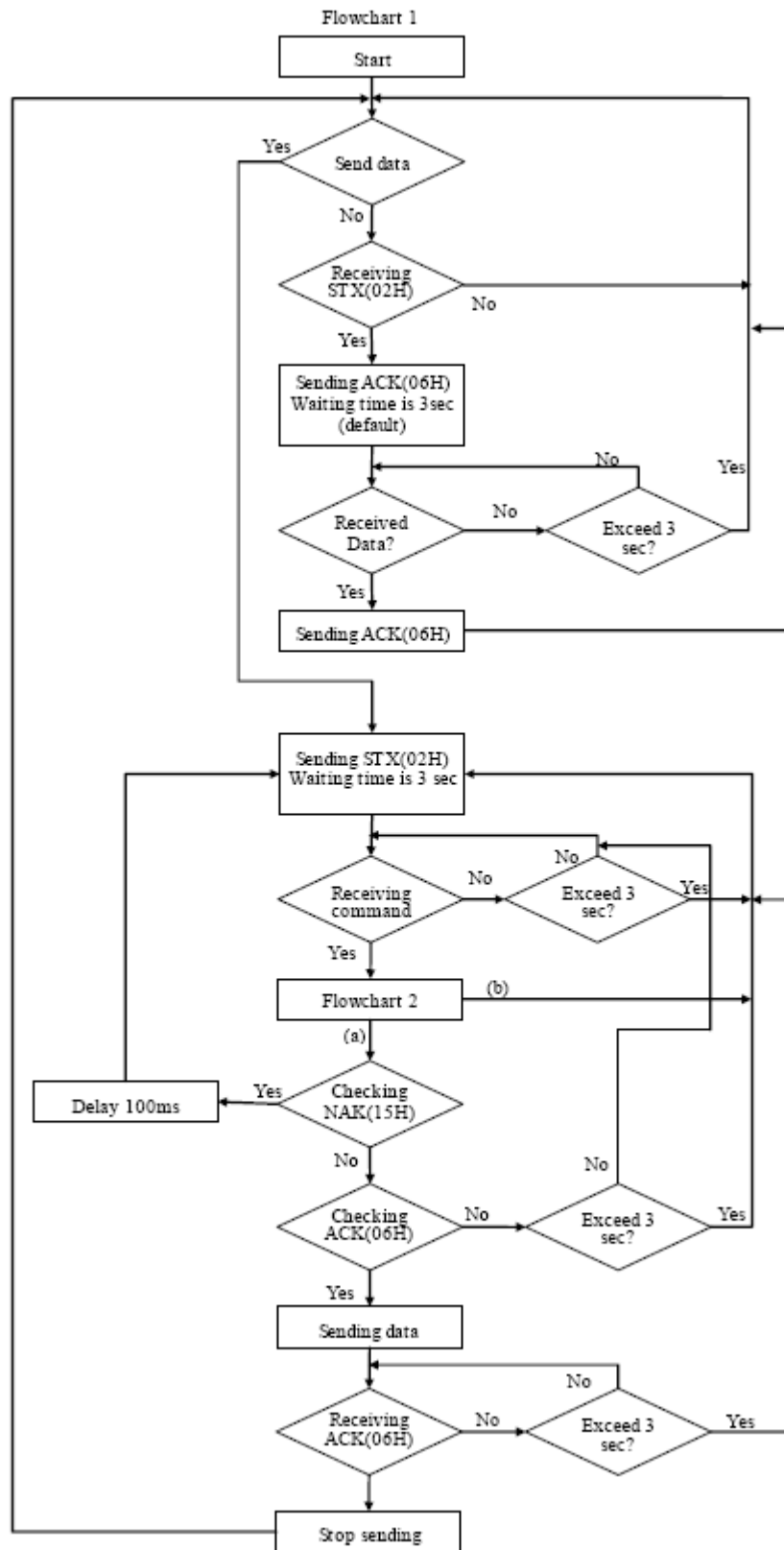

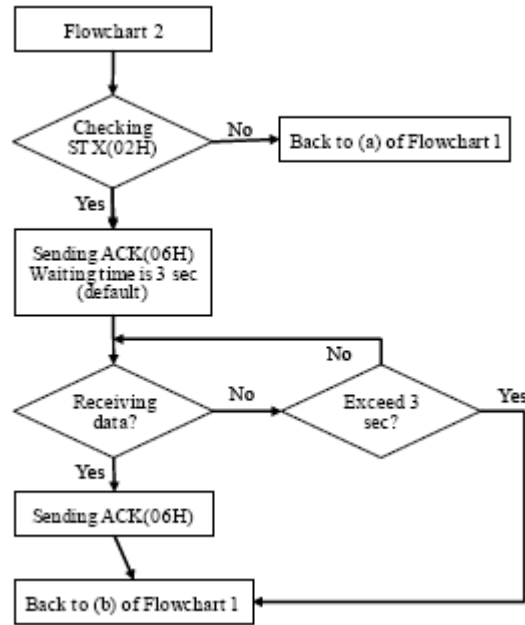

Note

- Flowchart 2 works for Slave but not Master.
- STX: Start of Text, ACK: Acknowledge, NAK: Negative Acknowledge

31.4. Address Types

There are two address types, MB and MW.

The format of the commands that controls MB are listed in the following table:

MB Commands		
Offset(byte)	Format	Description
0	0x02	The operating sign to MB
1	0x##	Address (Low byte)
2	0x##	Bit Address (High byte) For example: MB-18 = 1*16 + 2 = 18 = 0x12 and 0x00
3	0x00 (or 0x01)	The data in MB address. (Bit type, must be 0 or 1)
4, 5	0x10, 0x03	Stop sign
6	0x##	The checksum. Calculate XOR from offset 0 to 5.

The format of the commands that controls MW are listed in the following table:

MW Commands		
Offset(byte)	Format	Description
0	0x01	The operating sign to MW
1	0x##	Address (Low byte)
2	0x##	Bit Address (High byte) If the address includes 0x10, insert another 0x10 after it and all offsets after that are increased by 1. For example: 0x10, 0x04 will become 0x10,0x10,0x04
3	0x##	Number of sending bytes (To control a word, the number of bytes must be even). If the number of bytes is 0x10, insert another 0x10 after it and all offsets after that are increased by 1.
4 to 4+n-1	0x##(L),0x##(H) 0x##(L),0x##(H) ...	The address that the first and second bytes correspond to is the initial address. "n" is the number of bytes. If the data includes 0x10, insert another 0x10 after it and the "Number of sending bytes" (offset 3) remains the same, but n = n + 1. Same thing applies to other 0x10 data.
4+n,	0x10	End sign
4+n+1	0x03	
4+n+2	0x##	The checksum. Calculate XOR from all above.

31.4.1. Communication Examples

Example 1

If Master sets the data of MW-3 to 0x0a, Master will build communication with Slave immediately due to the data changed, so Slave will update its MW-3 to 0x0a, the procedure is:

1. Master sends STX(0x02h).
2. Slave receives STX(0x02h) from Master, and sends ACK(0x06h) to Master.
3. Master receives ACK(0x06h) from Slave.
4. Master sends 0x01,0x03,0x00,0x02,0x0a,0x00,0x10,0x03,0x19, as shown in the following table:

Offset(byte)	Format	Description
0	0x01	The operating sign for MW
1	0x03	Address(Low byte)
2	0x00	Bit Address (High byte)
3	0x02	The number of bytes sent (MW-3= two bytes).
4, 5	0x0a, 0x00	Data in MW-3 is 0x0a and 0x00
6, 7	0x10, 0x03	End sign
8	0x19	The checksum $0x01 \oplus 0x03 \oplus 0x00 \oplus 0x02 \oplus 0x0a \oplus 0x00 \oplus 0x10 \oplus 0x03 = 0x19$

5. Slave receives data from Master and then sends ACK(0x06h).

6. Master receives ACK(0x06h) from Slave.

When finish communicating, Master sends the updated data in MW to Slave, and Slave synchronizes its MW data with Master.

Example 2

If the data includes 0x10; please notice the change in data format.

If MW-10 of Slave is set to 0x10, Slave will build communication with Master immediately, and Master will update its MW-10 to 0x10, the procedure is:

1. Slave sends STX(0x02h)
2. Master receives STX(0x02h) from Slave, and sends ACK(0x06h) to Slave.
3. Slave receives ACK(0x06h) from Master
4. Slave sends 0x01,0x10,0x10,0x00,0x02,0x10,0x10,0x00,0x10,0x03,0x10 as shown in the following table:

Offset(byte)	Format	Description
0	0x01	The operating sign to MW
1	0x10	Address(Low byte)
2	0x10	Insert 0x10
3	0x00	Bit Address (High byte)
4	0x02	The number of bytes sent (MW-10= two bytes).
5	0x10	0x10 is the low byte in MW-10
6	0x10	Insert 0x10
7	0x00	0x00 is the high byte
8	0x10	End sign
9	0x03	
10	0x10	The checksum, $0x01 \oplus 0x10 \oplus 0x10 \oplus 0x00 \oplus 0x02 \oplus 0x10 \oplus 0x10 \oplus 0x00 \oplus 0x10 \oplus 0x03 = 0x10$

5. Master receives data from Slave and sends ACK(0x06h) to Slave.

6. Slave receives ACK(0x06h) from Master.

Slave sends the updated data in MW to Master, and Master synchronizes its MW data with Slave.

31.5. Settings

The following explains how to connect two HMIs using Memory Map protocol.

Note

- If the type of these two HMIs are different, please create different project files, or, after setting the first HMI, directly change to the type of the second HMI in [Edit] » [System Parameter Settings] » [Model], and then compile and download the project to the second HMI.

31.5.1. Steps to Add a Memory Map Device

1. Launch EasyBuilder Pro, select **[New]**, and the model of HMI.
2. Click [Edit] form the main menu, click [System Parameter Settings], and select [Device] tab, then click [New] to add a new device.
3. In the [Name] field enter “Memory Map”, and then select [PLC], set the [Location] to [Local].
4. Set [PLC type] to [Memory Map], and set [PLC I/F] to [RS-232].

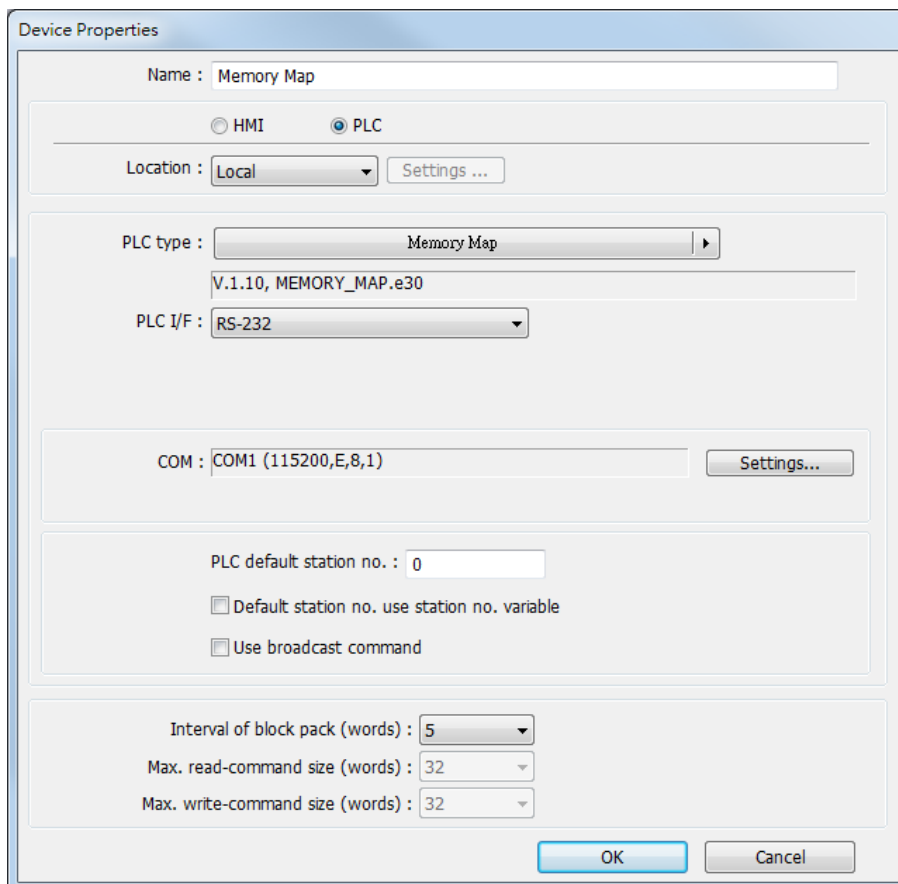

Device Properties

Name : Memory Map

HMI PLC

Location : Local Settings ...

PLC type : Memory Map

V.1.10, MEMORY_MAP.e30

PLC I/F : RS-232

COM : COM1 (115200,E,8,1) Settings...

PLC default station no. : 0

Default station no. use station no. variable

Use broadcast command

Interval of block pack (words) : 5

Max. read-command size (words) : 32

Max. write-command size (words) : 32

OK Cancel

5. Click [Settings], and the setting is shown in the following figure.

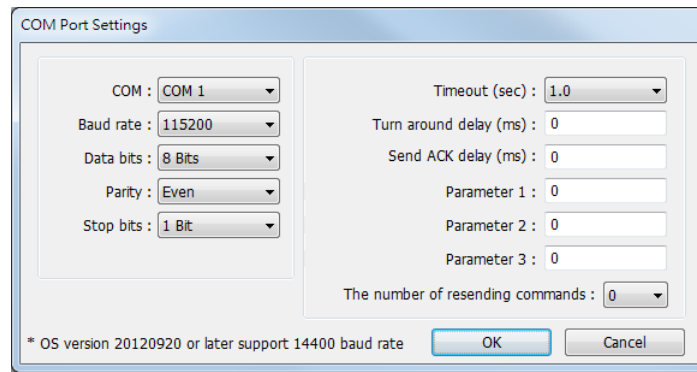

6. After setting the COM port click [OK].
7. Click [OK] to finish setting.

Note

- Memory Map in MT500 is divided into [Memory Map_Master] and [MemoryMap_Slave]; please refer to the relevant manual.
- For eMT3000 and MT8000 Series, select [Memory Map] in the PLC type setting.
- [Data bit] must set to 8 bits.
- All the settings of the two HMIs must be the same.

31.5.2. Object Settings

Add two objects in window no. 10, a Toggle Switch and a Multi-state Switch:
Create a Toggle Switch Object as shown in the following steps.

1. Set the [PLC name] of read address and write address to [Memory Map].
2. Set [Address] to MB-0.
3. Set [Switch style] to [Toggle]. (The picture and label of the object can be selected).

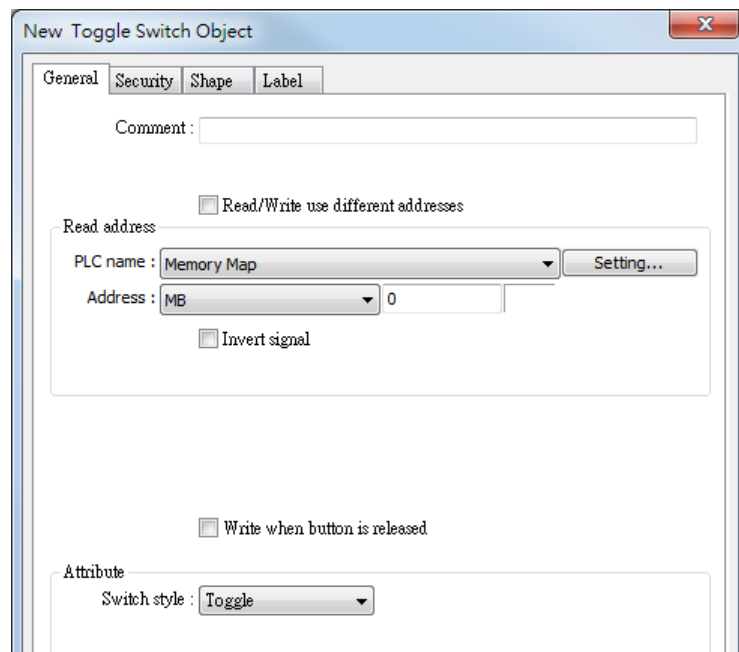

Create a Multi-state Object as shown in the following steps.

1. Set the [PLC name] of read address and write address to [Memory Map].
2. Set [Address] to MW-1.
3. Set [Cyclical] to [Enable]. (The picture and label of the object can be selected).

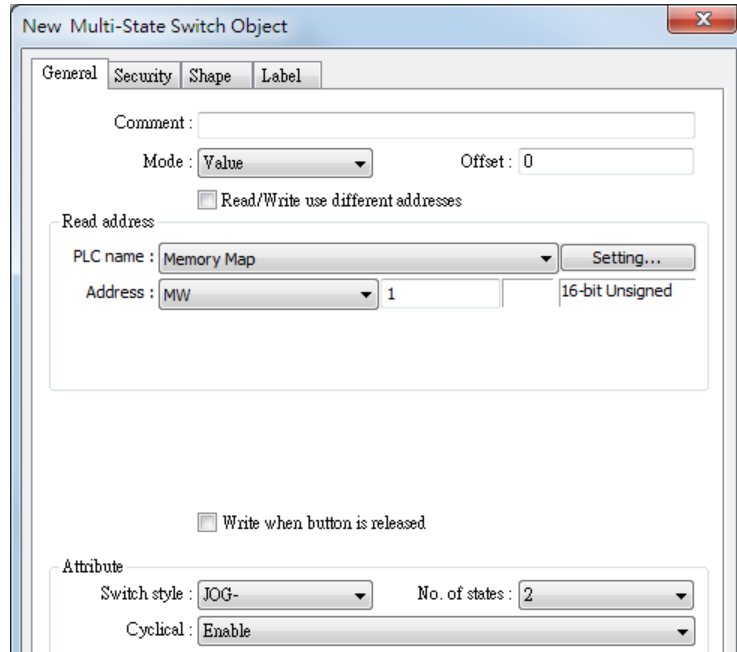

31.5.3. Executing the Settings

Compile and download the same project to HMI 1 and HMI 2.

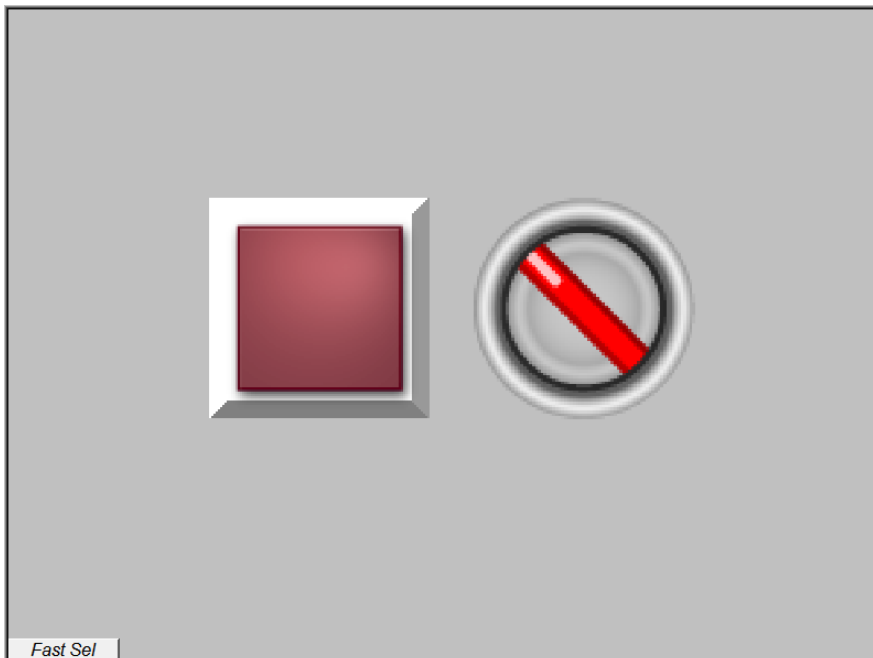

When pressing the button in one of the HMIs, the status of another one will also be changed. The way to connect a HMI with a controller is similar to the example above. The data in the same addresses of the two devices are kept identical.

32. FTP Server Application

This chapter explains how to use FTP Server.

32.1. Overview.....	32-2
32.2. Steps to Log in FTP Server	32-2
32.3. Backup History Data and Update Recipe Data	32-3

32.1. Overview

Apart from saving the history data from an HMI to your PC by using SD card, USB disk or EasyPrinter, the FTP Server can also do the backup. After downloading a project to the HMI, the FTP Server can be used to backup or update the history data and the recipe data, but not able to delete those data. Please disconnect from FTP before removing an SD card or USB disk, otherwise these external devices may not work when next time inserted.

32.2. Steps to Log in FTP Server

1. Before logging in FTP Server, please check the HMI IP address.

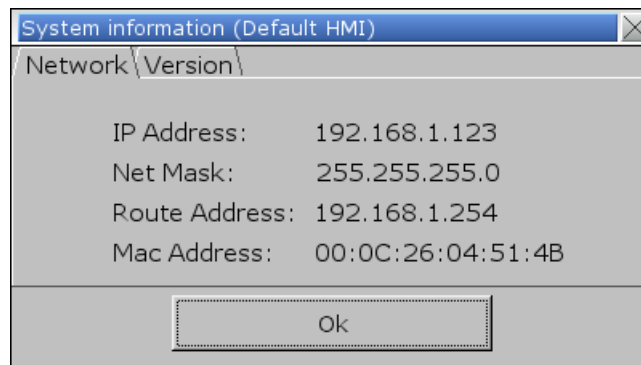

2. On PC, enter the HMI IP address: ftp://192.168.1.123/ (example), then log in by the user name: uploadhis, and enter the HMI [history upload password] (if not changed, the default password is 111111). Or, directly enter "ftp://uploadhis:111111@192.168.1.123/"

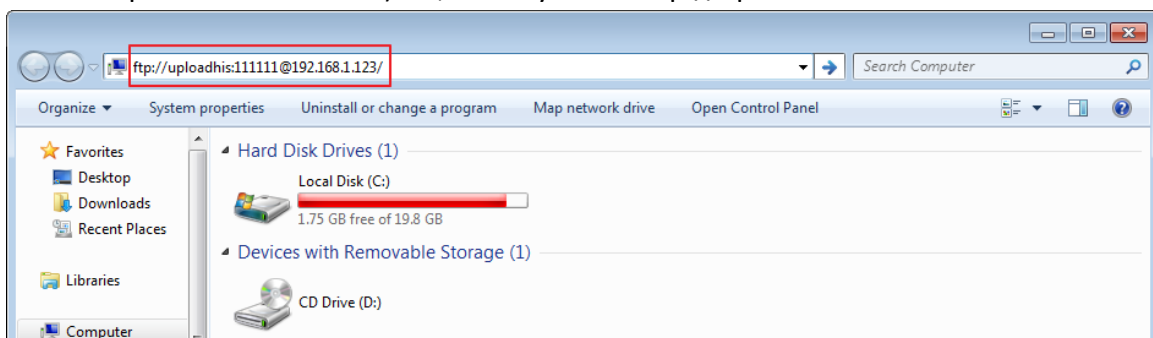

3. After entering the IP address, the ftp address: ftp://192.168.1.123 and its folders are shown as below:

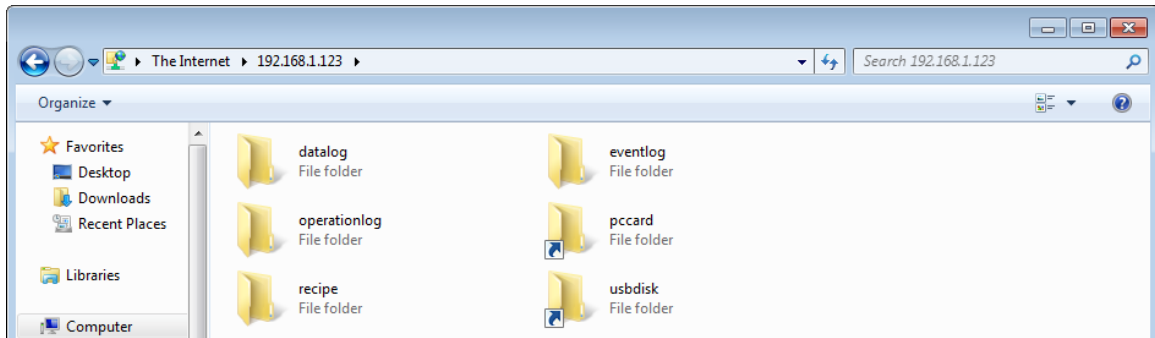

32.3. Backup History Data and Update Recipe Data

- Steps to backup Data Sampling records
 1. Click “datalog” folder to view the files.
 2. Click the file to check the records.
 3. Copy and paste the needed files to your PC.

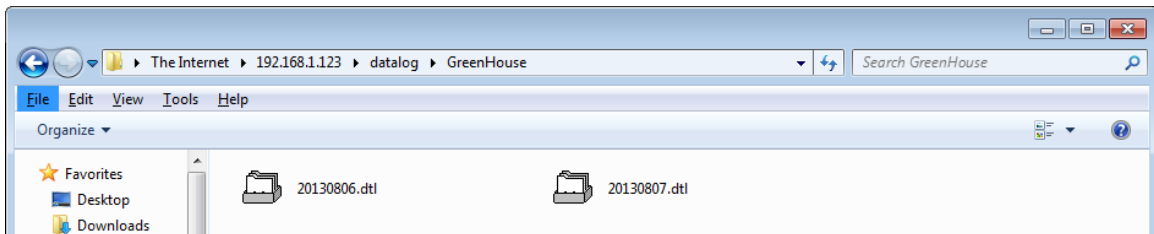

- Steps to backup Event (Alarm) Log records
 1. Click “eventlog” folder to view the files.
 2. Copy and paste the needed files to your PC.

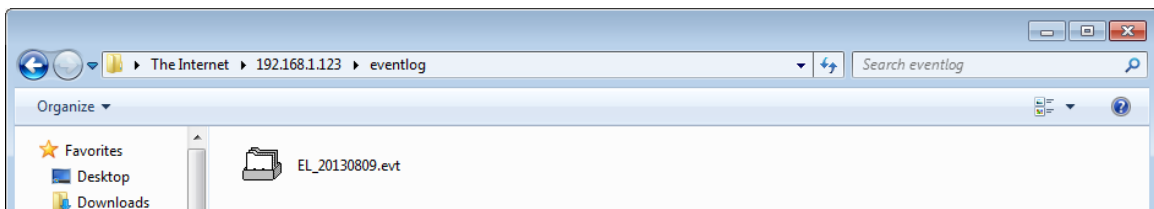

- Steps to backup or update Recipe records
 1. Click “recipe” folder to view the files.
 2. Copy and paste the needed files to your PC.

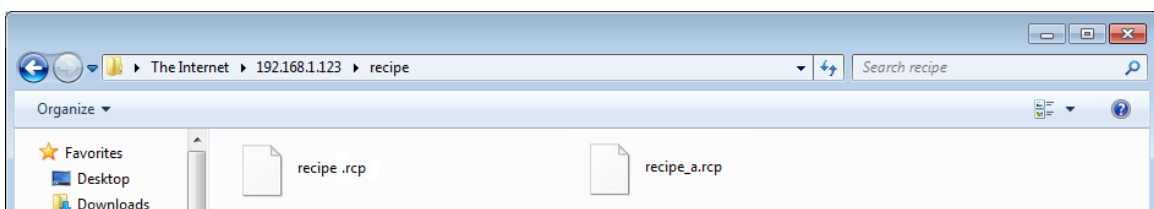

Note

- Since the recipe data is automatically saved per minute, after updating “recipe.rcp” or

“recipe_a.rcp”, the HMI must be rebooted within one minute or the saving will be failed.

- The HMI can be rebooted by the system registers: [LB-9047] (reboot HMI) and [LB9048] (reboot HMI protection). You can set [LB-9048] ON first, and then set [LB-9047] ON to reboot the HMI.

33. EasyDiagnoser

This chapter explains how to use EasyDiagnoser.

33.1. Overview	33-2
33.2. Configuration	33-2
33.3. EasyDiagnoser Settings	33-3
33.4. Error Code	33-9
33.5. Window Adjustment	33-10

33.1. Overview

EasyDiagnoser is a tool for detecting the error in the communication of HMI with PLC.

33.2. Configuration

The following steps explain how to configure EasyDiagnoser.

1. Open Utility Manager and click EasyDiagnoser.
2. Set the HMI IP address. Enter IP address or click [Search All], and then enter [Project Port].

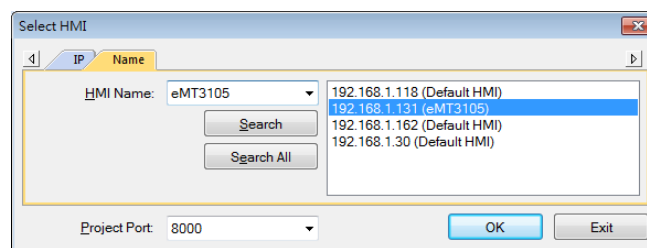
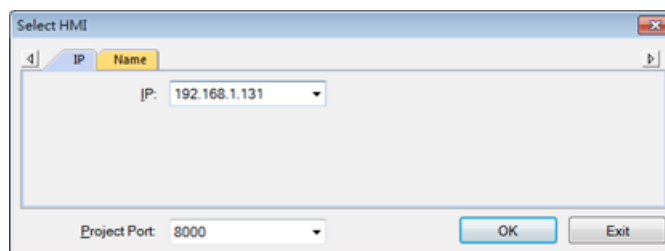

Or, during On-line simulation, right click and select [Run EasyDiagnoser] to open EasyDiagnoser. EasyDiagnoser will monitor the communication between PC and PLC.

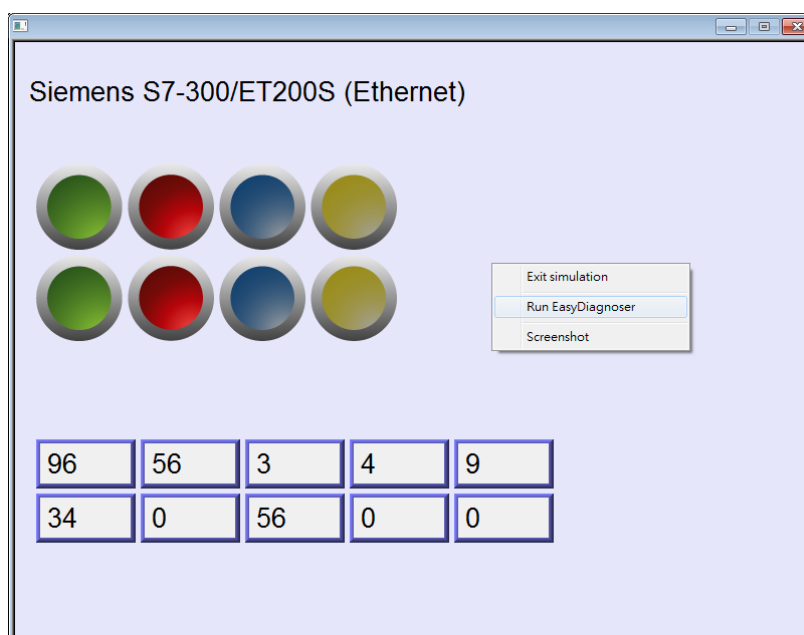

3. When finished, click [OK], EasyDiagnoser dialog box is shown in the following figure.

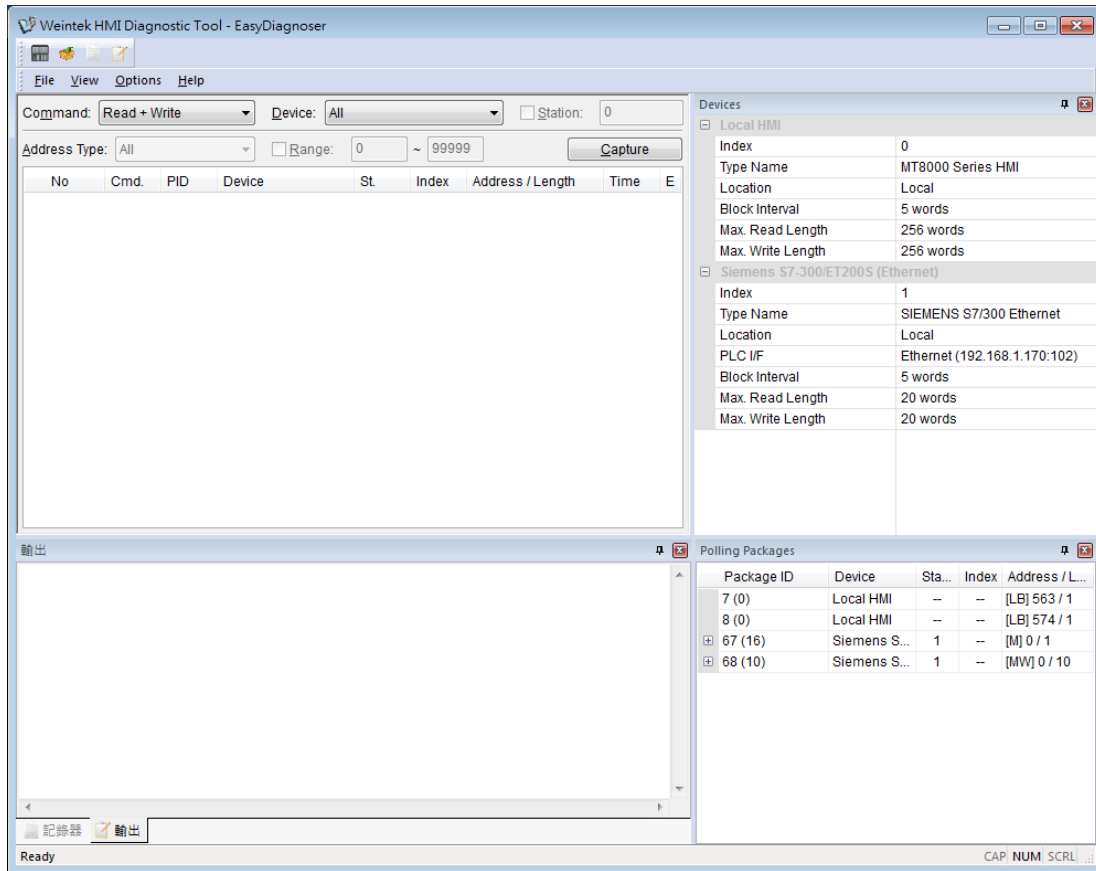

33.3. EasyDiagnoser Settings

33.3.1. Main Menu

Item	Description
File	<p>Save As The communication data can be saved as .xls file which can be opened by Excel.</p> <p>Exit Exits current file.</p>
View	<p>Device Bar displays Device window.</p> <p>Package Bar displays Package window.</p> <p>Logger Bar displays Logger window.</p> <p>Output Bar displays Output window.</p>
Options	<p>Toolbars displays toolbar icons of Device Bar, Package Bar, Logger Bar, and Output Bar.</p>

Status Bar displays information of CAP, NUM, and SCRL at the bottom of EasyDiagnoser window.

Update Package List displays the Polling Package information of current page.

Show Object ID (HMI) shows the ID of the objects on HMI as shown in the following figure.



Clear Activity List clears all the information recorded during communication.

Help Displays EasyDiagnoser version information.

33.3.2. Activity Area

In the activity area, users can observe the communication between HMI and PLC.

No	Cmd.	PID	Device	St.	Index	Address / Length	Time	E
1270	R	67	Siemens S7-300/E...	1	--	[M] 0 / 1	20	0
1269	R	8	Local HMI	--	--	[LB] 574 / 1	20	0
1268	R	7	Local HMI	--	--	[LB] 563 / 1	20	0
1267	R	68	Siemens S7-300/E...	1	--	[MW] 0 / 10	20	0
1266	R	8	Local HMI	--	--	[LB] 574 / 1	20	0
1265	R	7	Local HMI	--	--	[LB] 563 / 1	20	0
1264	R	67	Siemens S7-300/E...	1	--	[M] 0 / 1	30	0
1263	R	68	Siemens S7-300/E...	1	--	[MW] 0 / 10	30	0
1262	R	8	Local HMI	--	--	[LB] 574 / 1	20	0
1261	R	7	Local HMI	--	--	[LB] 563 / 1	20	0
1260	R	67	Siemens S7-300/E...	1	--	[M] 0 / 1	10	0

Item	Description
------	-------------

Command	Read + Write
----------------	---------------------

Displays Read and Write information in activity area.

Read

Displays only Read information in activity area.

	<p>Write</p> <p>Displays only Write information in activity area.</p>
Device	<p>All</p> <p>Displays the information of Local HMI and PLC.</p> <ul style="list-style-type: none"> ● If command is set to Read + Write, the Read and Write information of Local HMI and PLC will be displayed in the activity area. ● If command is set to Read, the Read information of Local HMI and PLC will be displayed in the activity area. ● If command is set to Write, the Write information of Local HMI and PLC will be displayed in the activity area. <p>Local HMI</p> <p>Displays the information of Local HMI.</p> <ul style="list-style-type: none"> ● If command is set to Read + Write, the Read and Write information of Local HMI will be displayed in the activity area. ● If command is set to Read, the Read information of Local HMI will be displayed in the activity area. ● If command is set to Write, the Write information of Local HMI will be displayed in the activity area. <p>PLC</p> <p>Displays the information of PLC.</p> <ul style="list-style-type: none"> ● If command is set to Read + Write, the Read and Write information of PLC will be displayed in the activity area. ● If command is set to Read, the Read information of PLC will be displayed in the activity area. ● If command is set to Write, the Write information of PLC will be displayed in the activity area.
Station	<p>Selects the PLC station number to be displayed. (This function is disabled when selecting [All] in [Device]).</p>
Address Type	<p>Selects all or a preferred address type to be displayed. (This function is disabled when selecting [All] in [Device]).</p>
Range	<p>Sets the range of address types. (This function is disabled when selecting [All] in [Device]).</p>
Capture	<p>Click to start/stop capturing the communication message.</p>
Error	<p>Please see "33.4 Error Code".</p>

33.3.3. Polling Packages

Package ID	Device	Station	Index	Address / Length
7 (0)	Local HMI	--	--	[LB] 563 / 1
8 (0)	Local HMI	--	--	[LB] 574 / 1
⊕ 67 (16)	Siemens S7-300/ET20...	1	--	[M] 0 / 1
⊕ 68 (10)	Siemens S7-300/ET20...	1	--	[MW] 0 / 10

Item	Description
Package ID	Uses the Package ID to check the error of the object.
Device	Displays HMI and PLC type.
Station	Displays PLC station number.
Index	Displays the index register numbers of the objects.
Address / Length	Displays the device type and the size of the package (in words).

Object	Device	Screen	ID	Address
7 (0)	Local HMI	--	--	[LB] 563 / 1
8 (0)	Local HMI	--	--	[LB] 574 / 1
⊖ 67 (16)	Siemens S7-300/ET...	1	--	[M] 0 / 1
▶ Toggle Switch		10	1	[M] 0
Toggle Switch		10	1	[M] 0
Toggle Switch		10	12	[M] 0
Toggle Switch		10	12	[M] 0
Toggle Switch		10	13	[M] 0
Toggle Switch		10	13	[M] 0
Toggle Switch		10	14	[M] 0
Toggle Switch		10	14	[M] 0
Toggle Switch		10	15	[M] 0
Toggle Switch		10	15	[M] 0
Toggle Switch		10	16	[M] 0

Item	Description
Object	Check the object in the package.
Screen	The window in the project where the object is placed.
ID	The ID number of the object.
Address	The address of the object.

 **Note**

- Click [Package ID], the device station number will be displayed in the 3rd column.

Package ID	Device	Station	Index	Address / Length
7 (0)	Local HMI	--	--	[LB] 563 / 1
8 (0)	Local HMI	--	--	[LB] 574 / 1
67 (16)	Siemens S7-300/ET20...	1	--	[M] 0 / 1
68 (10)	Siemens S7-300/ET20...	1	--	[MW] 0 / 10

- Double click [Package ID] then select [object] to display the position of the object. For example, select [Numeric Input] and the screen no. displays 10. This shows that this object is in window no. 10 in the project and will be marked with pink frame on HMI as shown in the following figures

Object	Device	Screen	ID	Address
7 (0)	Local HMI	--	--	[LB] 563 / 1
8 (0)	Local HMI	--	--	[LB] 574 / 1
67 (16)	Siemens S7-300/ET20...	1	--	[M] 0 / 1
68 (10)	Siemens S7-300/ET20...	1	--	[MW] 0 / 10
▶ Numeric Input		10	2	[MW] 0
Numeric Input		10	3	[MW] 2
Numeric Input		10	4	[MW] 4
Numeric Input		10	5	[MW] 6
Numeric Input		10	6	[MW] 8
Numeric Input		10	7	[MW] 10
Numeric Input		10	8	[MW] 12
Numeric Input		10	9	[MW] 14
Numeric Input		10	10	[MW] 16
Numeric Input		10	11	[MW] 18

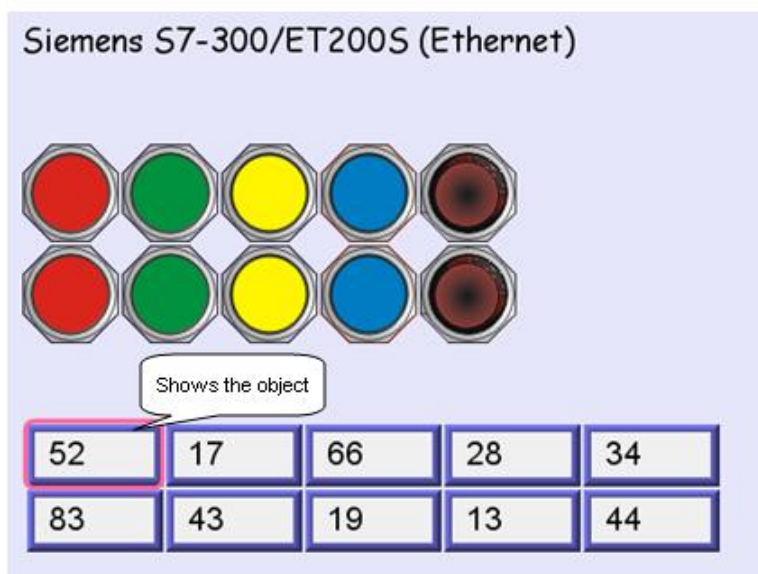

33.3.4. Devices

Displays the information of HMI and PLC.

Devices	
[-] Local HMI	
Index	0
Type Name	MT8000 Series HMI
Location	Local
Block Interval	5 words
Max. Read Length	256 words
Max. Write Length	256 words
[-] Siemens S7-300/ET200S (Ethernet)	
Index	1
Type Name	SIEMENS S7/300 Ethernet
Location	Local
PLC I/F	Ethernet (192.168.1.170:102)
Block Interval	5 words
Max. Read Length	20 words
Max. Write Length	20 words

33.3.5. Output (Macro debug)

With Macro Trace function, the executing status of Macro can be seen.

In the illustration below, for [ID 1, Ln 7] and [ID 1, Ln 12]

ID 1 represents Macro name.

Ln 7 and Ln 12 represent that data are in the 7th and 12th line of Macro.

Output	
[ID 1, Ln 7]	LW0 = 1
[ID 1, Ln 12]	LW0 = 2
[ID 1, Ln 7]	LW0 = 2
[ID 1, Ln 12]	LW0 = 3
[ID 1, Ln 7]	LW0 = 3
[ID 1, Ln 12]	LW0 = 4

 For more information, see “18 Macro Reference”.

33.4. Error Code

In the activity area, the reason of error can be found through the error codes listed below.

Error Code	Cause of Communication Error
0	Normal
1	The device is busy and not yet ready to process a command.
2	Communication error due to unexpected reason.
3	The device does not exist.
4	The device using the specified station number does not exist.
5	Incorrect address format.
6	Read/Write unsupported address.
7	The driver of the device does not exist.
8	The COM port does not exist.
9	Incorrect IP address or unable to connect the device.
10	Checksum error.
11	Unidentified command.
12	Ignore
20	The USB device is improperly connected.
21	The CAN Bus device is improperly connected.
22	No reply from the device.
23	Insufficient data read from the device before timeout.
24	The Conversion Tag used by the object does not exist or the content is incorrect.
25	HMI is not accepting any commands from a remote HMI.
251	Read/Write exceeding number of words from/to the register of the MODBUS device.
252	MODBUS device replies incorrect data format.
253	MODBUS device checksum error.

When error occurs, the error message will be shaded red as shown in the following figure.

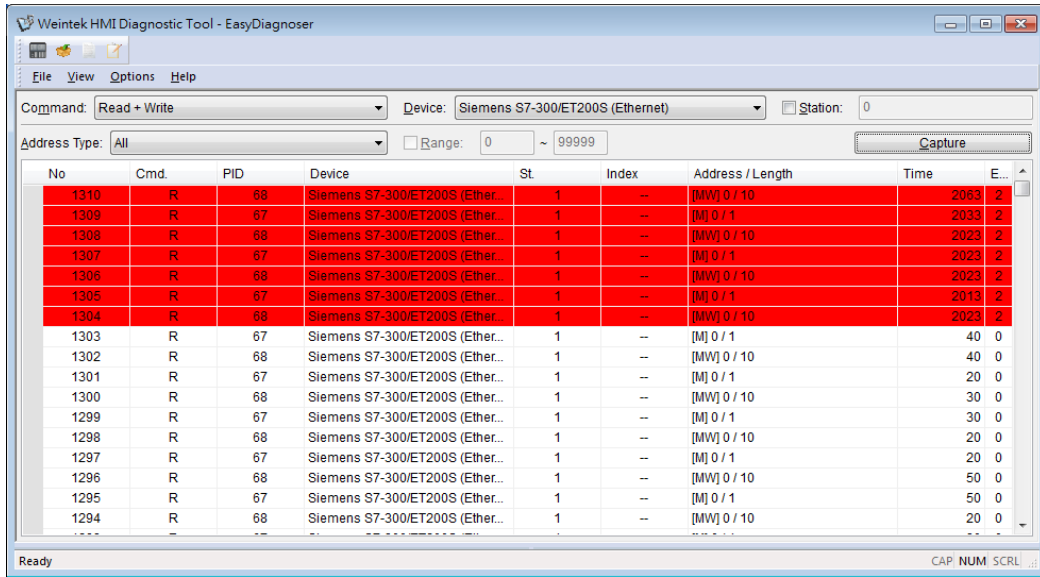

33.5. Window Adjustment

Users can drag or use the smart docking icons in editing window to place the windows to a desired position.

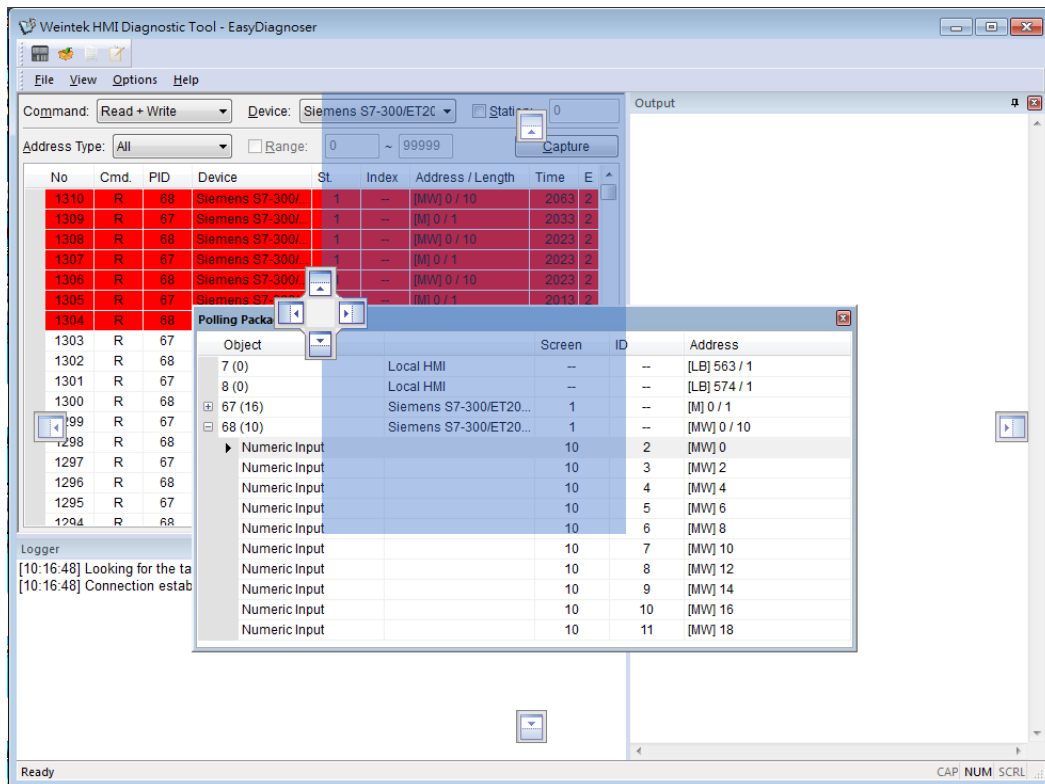

Note

- EasyDiagnoser doesn't support Siemens S7/1200 (Ethernet) and Allen-Bradley Ethernet/IP (CompactLogix/ControlLogix) – Free Tag Names since both of the PLCs use tag.

34. Rockwell EtherNet/IP Free Tag Names

This chapter explains how to use Rockwell EtherNet / IP Free Tag Names.

- 34.1. Overview..... 34-2
- 34.2. Steps to Import User-Defined AB Tag CSV File to EasyBuilder Pro 34-2
- 34.3. Steps to Add a New Data Type..... 34-4
- 34.4. Steps to Paste 34-6
- 34.5. Miscellaneous Functions 34-7
- 34.6. Module-Defined..... 34-8

34.1. Overview

When using Rockwell EtherNet/IP Free Tags (CompactLogix/ControlLogix) driver, the User-defined tag in RSLogix5000 can be exported to .csv file, and then imported to EasyBuilder Pro.

However, the tags in User-Defined, Predefined and Module-Defined will not be exported. Structure Editor in EasyBuilder Pro is then used for importing and editing tags of data structures in User-Defined, Predefined and Module-Defined.

	A	B	C	D	E	F	
7	TYPE	SCOPE	NAME	DESCRIPT	DATATYPE	SPECIFIER	ATTRIBUTES
8	TAG		Local:1:C		AB:Embedded_IQ16F:C:0		
9	TAG		Local:1:I		AB:Embedded_IQ16F:I:0		
10	TAG		Local:2:C		AB:Embedded_OB16:C:0		
11	TAG		Local:2:I		AB:Embedded_OB16:I:0		
12	TAG		Local:2:O		AB:Embedded_OB16:O:0		
13	TAG		Array2D		DINT[25,5]		(RADIX := Decimal, Cons
14	TAG		ArrayBool		BOOL[256]		(RADIX := Decimal, Cons
15	TAG		ArrayDINT		DINT[130]		(RADIX := Decimal, Cons
16	TAG		ArrayReal		REAL[125]		(RADIX := Float, Constant
17	TAG		B001		INT[15]		(RADIX := Decimal, PLC)
18	TAG		b003		INT[255]		(RADIX := Decimal, PLC)
19	TAG		b1		BOOL		(RADIX := Decimal, Cons

34.2. Steps to Import User-Defined AB Tag CSV File to EasyBuilder Pro

1. Create Tags in RSLogix5000.

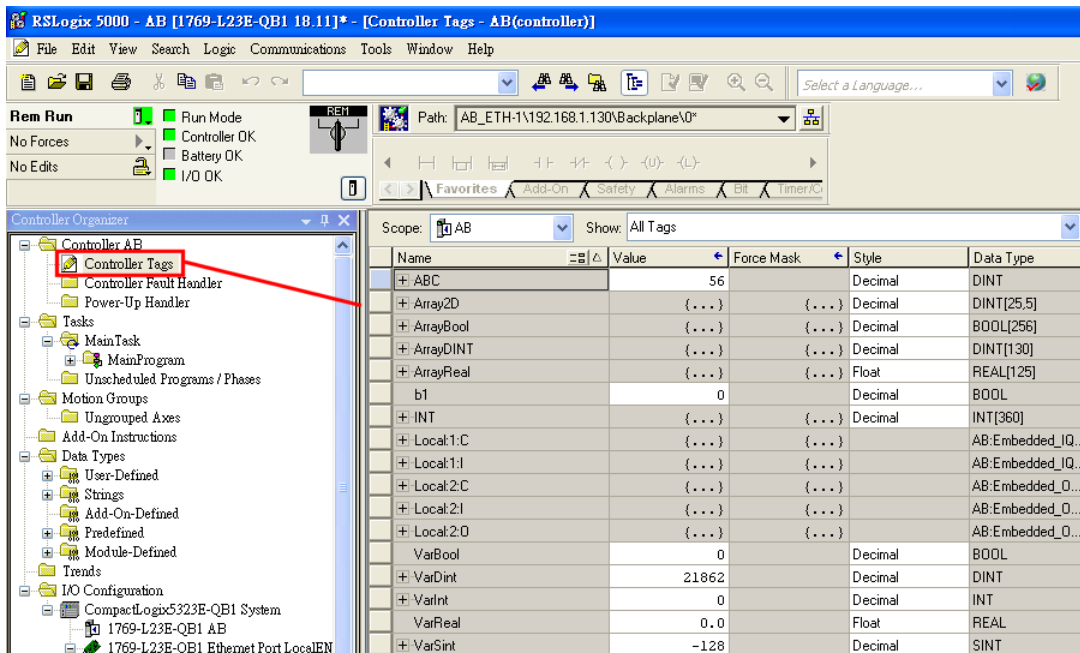

2. Export Tags to .csv file.

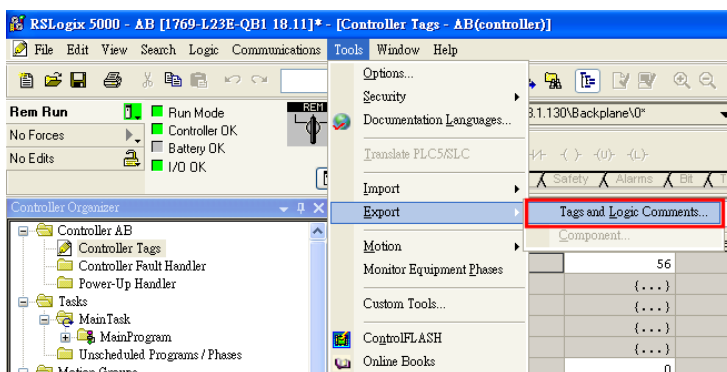

- In EasyBuilder Pro, add Rockwell EtherNet/IP-Tag (CompactLogix/ControlLogix) driver. Enter PLC IP address and click [Import Tag].

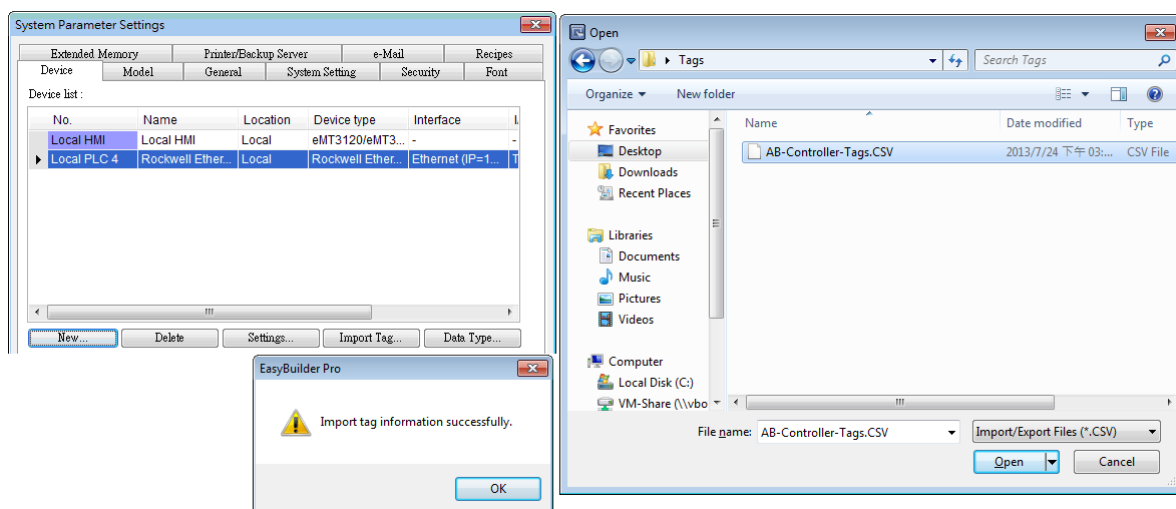

- In the object setting dialog, select the PLC type, and select a controller tag.

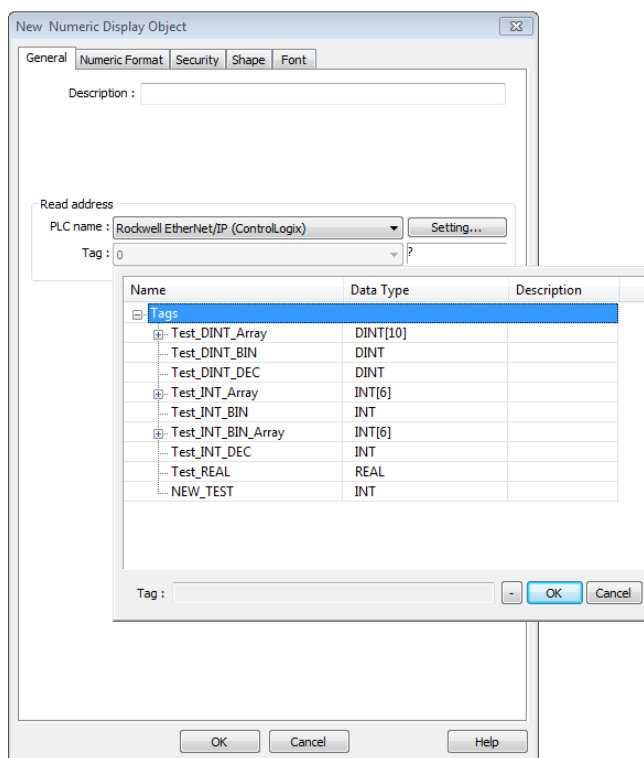

34.3. Steps to Add a New Data Type

Structure Editor is in the installation directory of EasyBuilder Pro. Double-click Structure Editor.exe and the editor window will appear. See the following steps.

1. Right click the assigned data type (usually labeled as User-Defined), then click [New Data Type] to start editing.

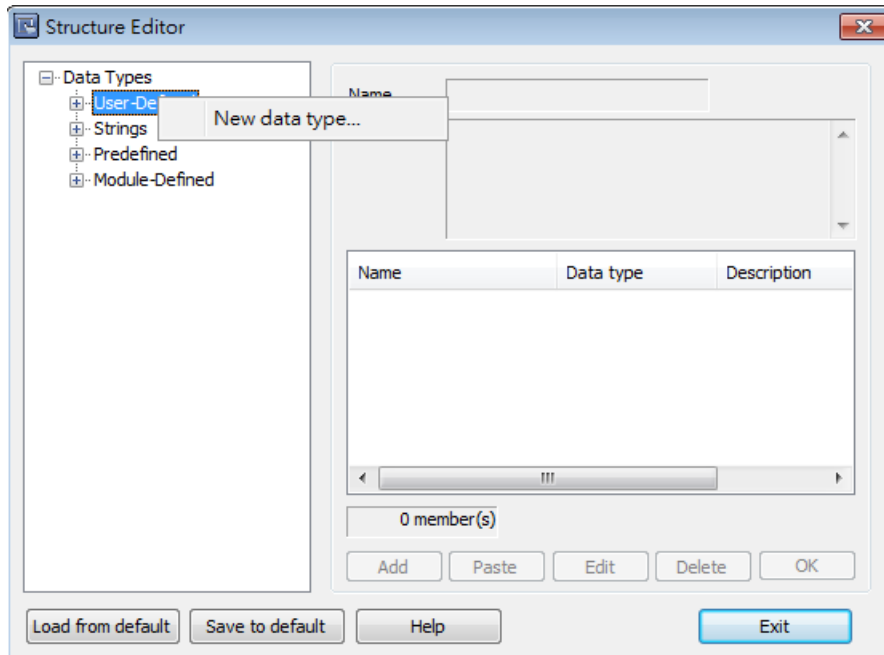

2. Enter the name of the data type. [Description] field can be left blank. To add a member, click [Add].

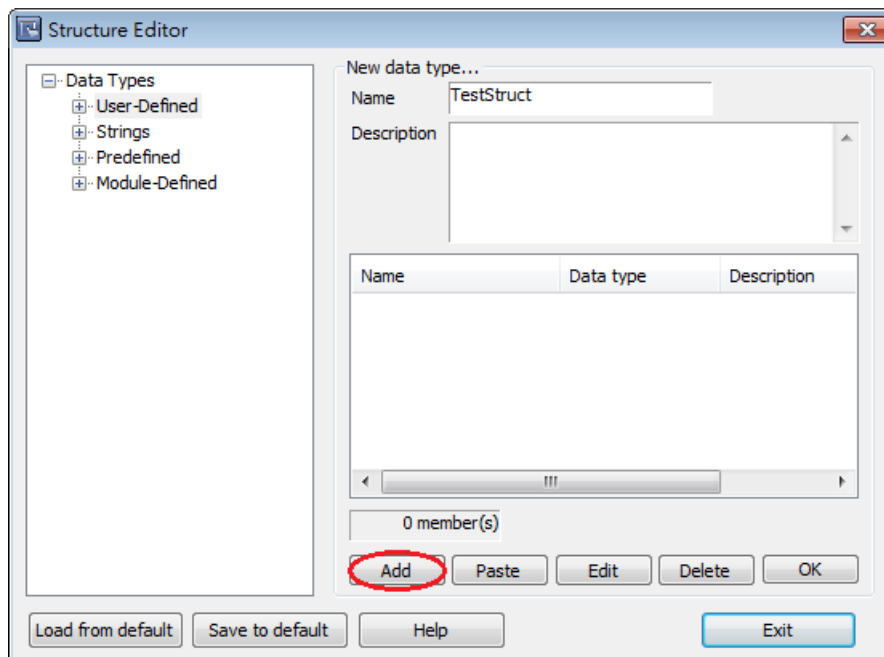

3. Enter the name and the data type then click [OK].

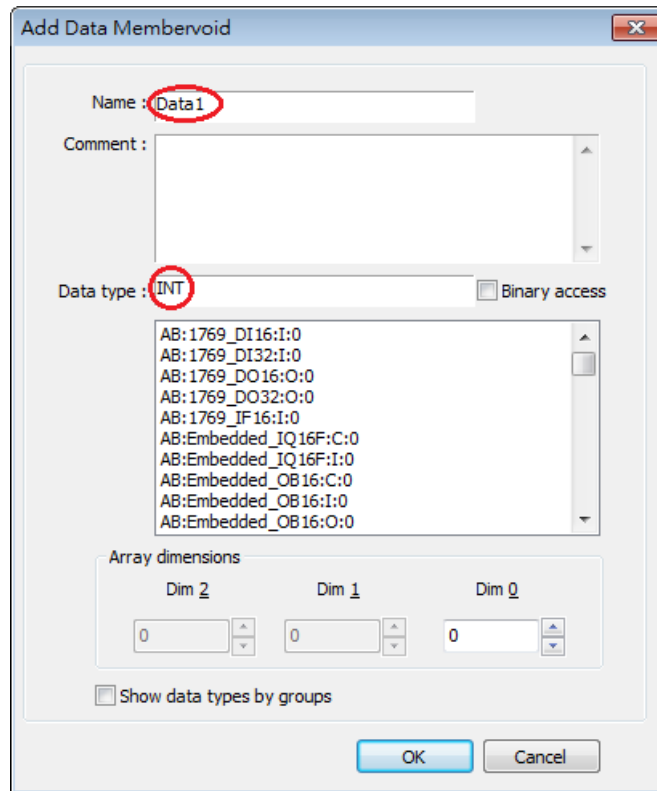

4. After adding all members, click [OK]. The new data type will be added to the list of data types.

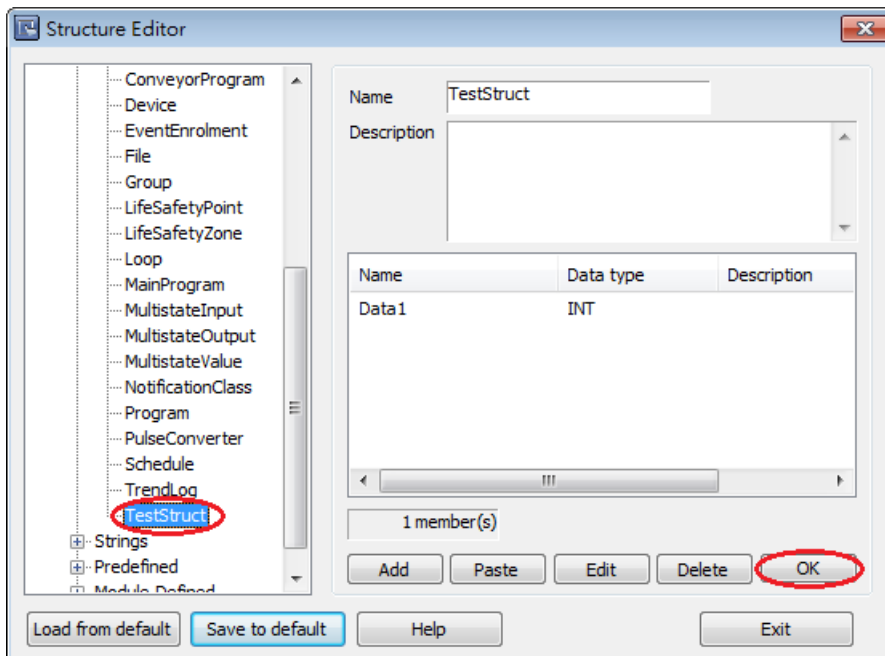

5. After changing the name or description of a data type, click [OK] to update.

34.4. Steps to Paste

1. When adding a patch of members, this function allows users to add multiple data in one step. First, click the [Paste] button.

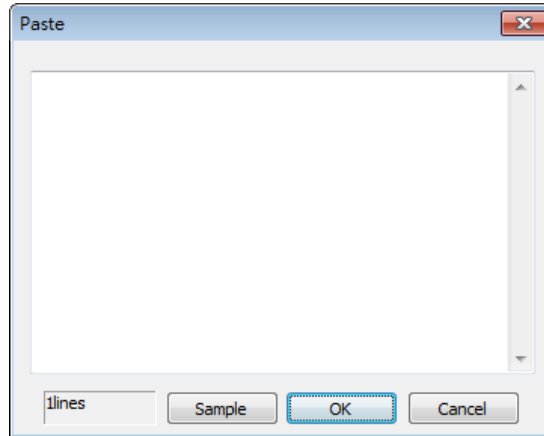

2. Type in data name, and then enter data type, separated by Space key or Tab key. It is recommended that data be directly copied and pasted from RSLogix5000 to avoid errors. Users can click [Sample] for a formatting example.

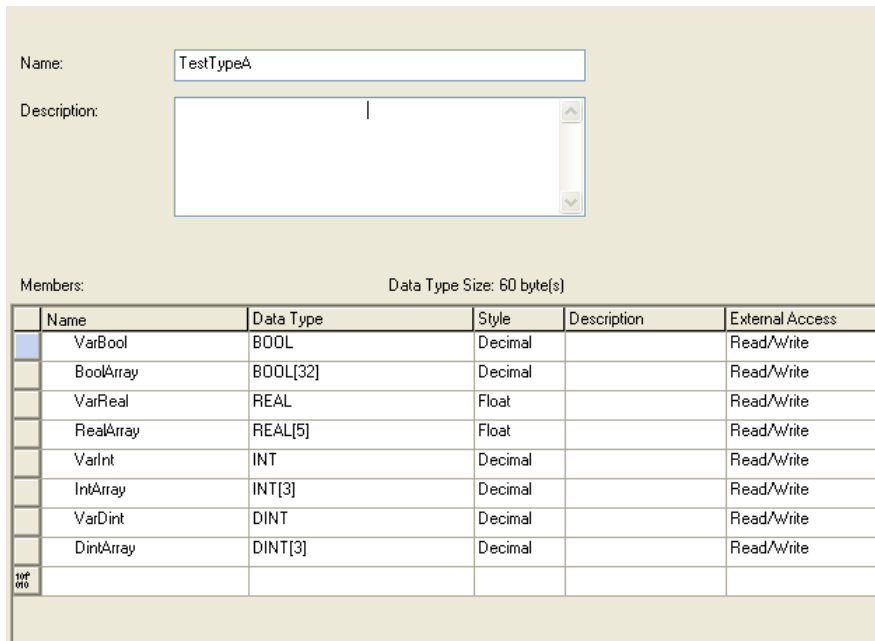

3. Copy the needed Name and Data defined in RSLogix such as one shown above. Paste the content in the editing window, as shown in the following figure.

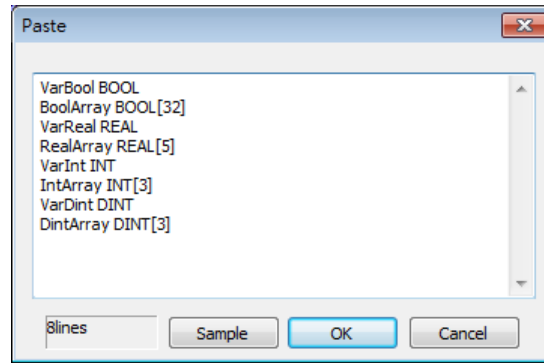

- Click [OK] to finish setting, and return to the main menu to check the added data.

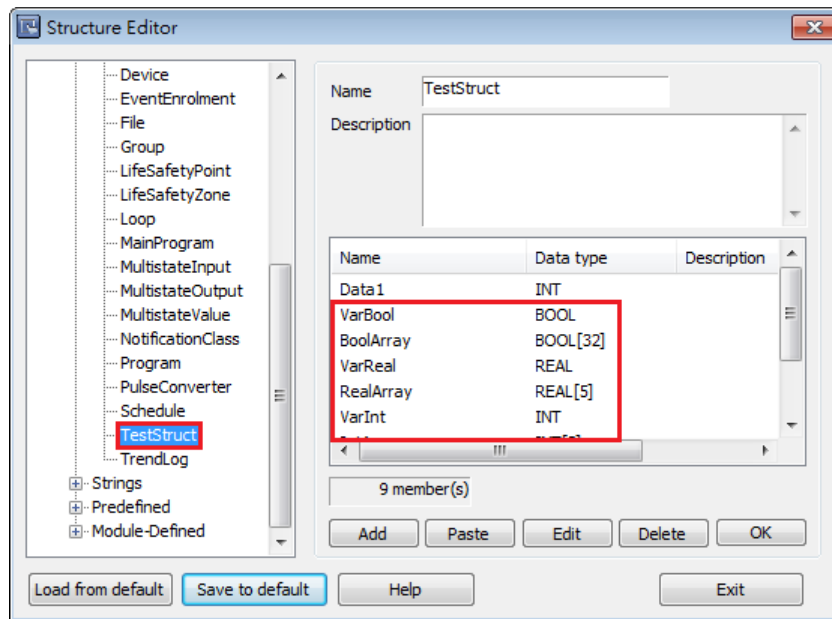

34.5. Miscellaneous Functions

- Revising member data**
 Double click the member to be revised, or click the member then click [Edit].
- Deleting member data**
 Select the data to be deleted then click [Delete]. To delete all members of a data type, press and hold the Delete button on the keyboard and then click the [Delete] button in the dialog box.
- Deleting a data type**
 Select the data type from the list on the left and then press the Delete key on the keyboard.
- Load from Default**
 To start over from default settings, click [Load from Default] button.
- Save to Default**
 Saves data type settings to default for use in other projects.

34.6. Module-Defined

Module-Defined is a default structure of a module.

Here is an example showing how to define the default structure of a module.

In RSLogix5000 [I/O Configuration], the I/O module is set.

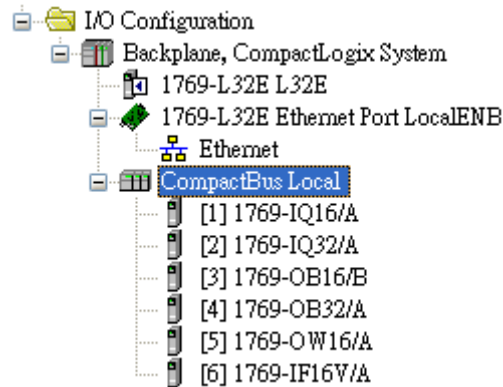

The exported CSV file will not list tags that are associated with module-defined structure.

Please define the tags manually by following the steps below.

	A	B	C	D	E	F	G	H
7	TYPE	SCOPE	NAME	DESCRIPT	DATATYPE		SPECIFIER	ATTRIBUTES
8	TAG		Local:1:I		AB:1769_DI16:I:0			
9	TAG		Local:2:I		AB:1769_DI32:I:0			
10	TAG		Local:3:C		AB:1769_DO16:C:0			
11	TAG		Local:3:I		AB:1769_DO16:I:0			
12	TAG		Local:3:O		AB:1769_DO16:O:0			
13	TAG		Local:4:C		AB:1769_DO32:C:0			
14	TAG		Local:4:I		AB:1769_DO32:I:0			
15	TAG		Local:4:O		AB:1769_DO32:O:0			
16	TAG		Local:5:C		AB:1769_DO16:C:0			
17	TAG		Local:5:I		AB:1769_DO16:I:0			
18	TAG		Local:5:O		AB:1769_DO16:O:0			
19	TAG		Local:6:C		AB:1769_IF16:C:0			
20	TAG		Local:6:I		AB:1769_IF16:I:0			
21	TAG		Local:6:O		AB:1769_IF16:O:0			

1. In RSLogix5000 [Controller Organizer] » [Data Types] » [Module-Defined], double click Data Type of the module. Members of the module will be shown in a popup dialog. Copy the Name and Data Type of the members.

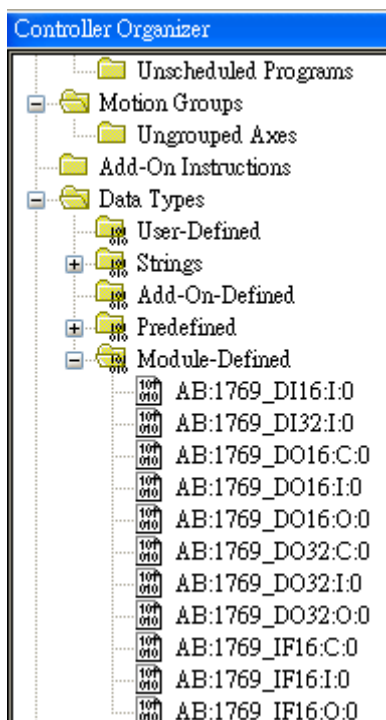

- In Structure Editor, right click [Module-Defined], and then click [New Data Type]. In [New Data Type] » [Name], enter the Module-Defined name.

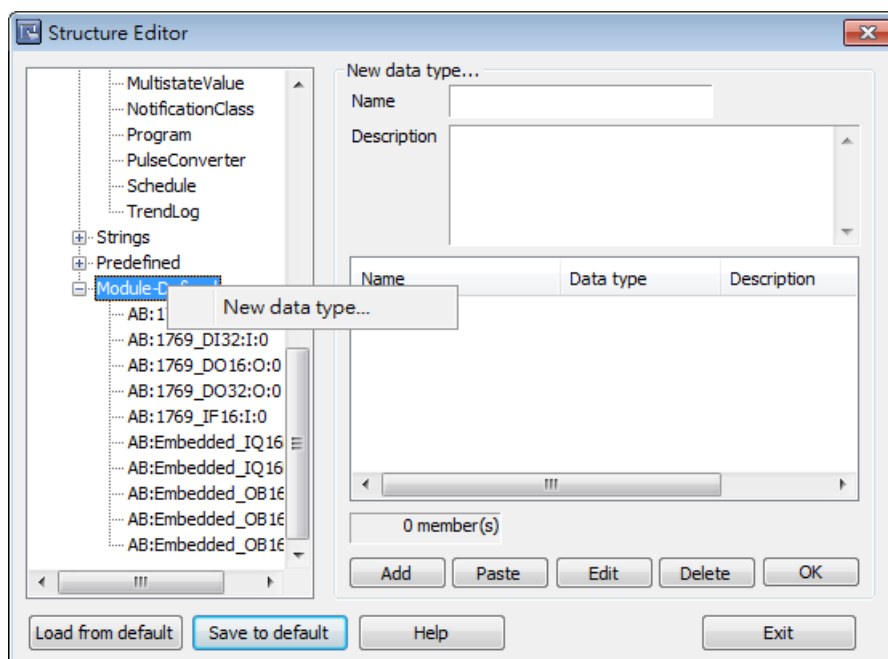

3. Click [Paste], and paste the data type information in the dialog box.

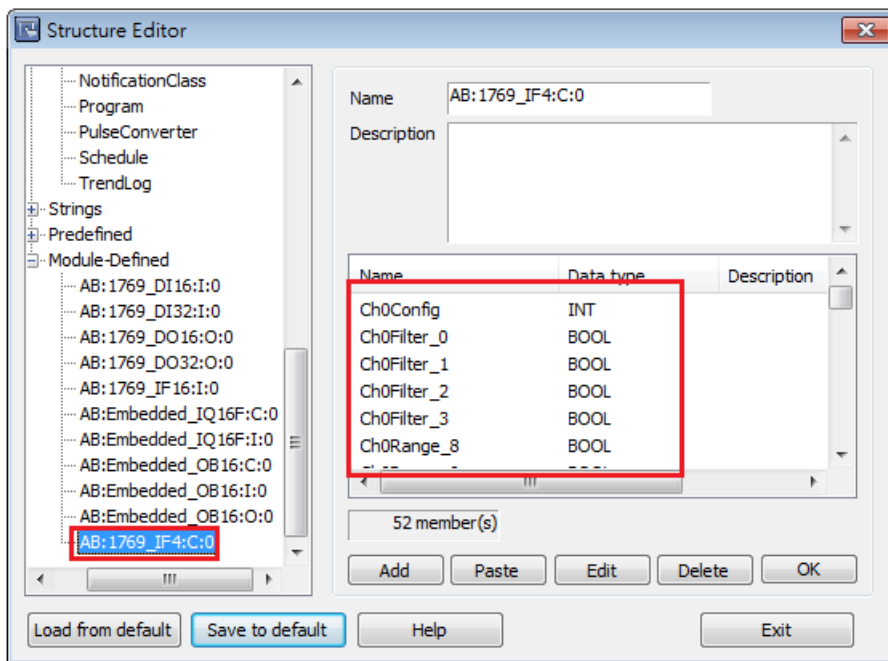
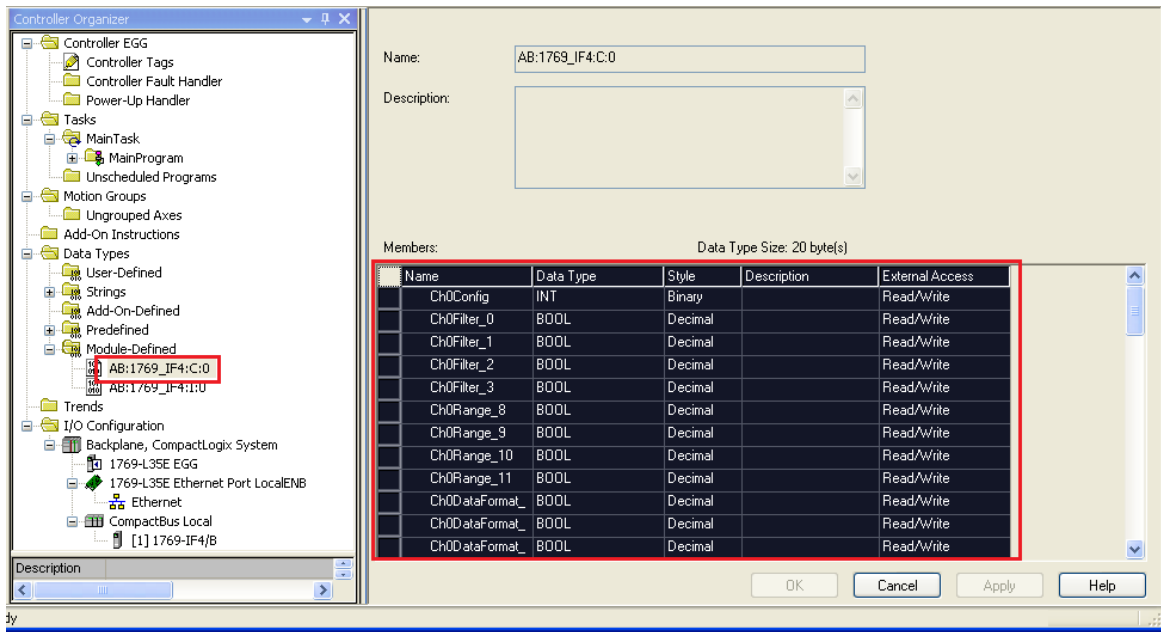

4. Select a member and then click [Edit]. Since the data of the modules allows bit-wise operation, [Binary Access] should be selected, then click [OK] to return to Structure Editor.

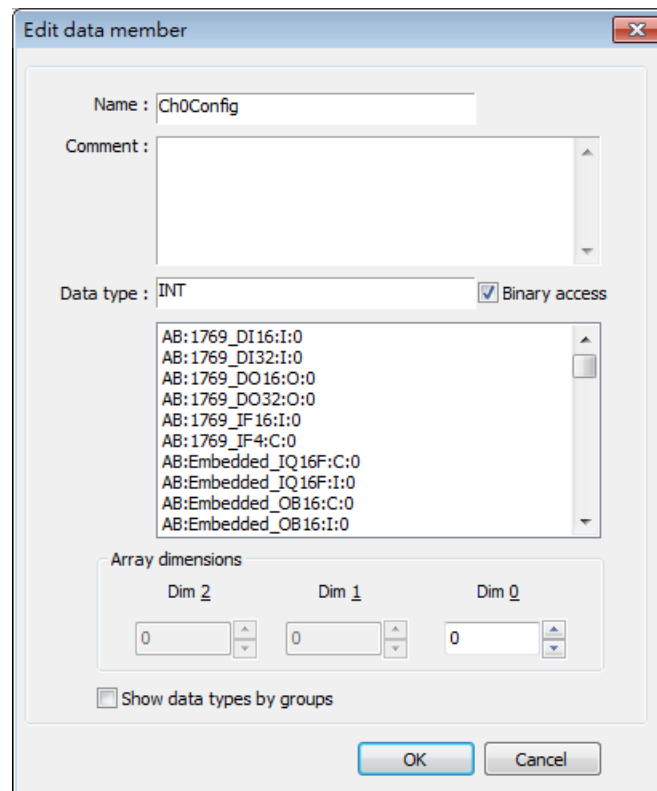

5. Click [OK] to finish setting.

35. EasyWatch

This chapter explains how to use EasyWatch.

35.1. Overview.....	35-2
35.2. Configuration	35-2
35.3. Monitor Settings	35-4
35.4. Macro Settings	35-8
35.5. HMI Manager	35-9
35.6. Object List	35-11

35.1. Overview

EasyWatch allows users to monitor the HMI or the PLC address values via Ethernet from the PC, or to invoke the Macro for debugging, remote monitoring, and controlling.

For example, In EasyBuilder Pro, after creating a Numeric Input Object, you can set its address to LW-10, and set the same address in EasyWatch. The value of LW-10 will be shown in EasyWatch when successfully connecting.

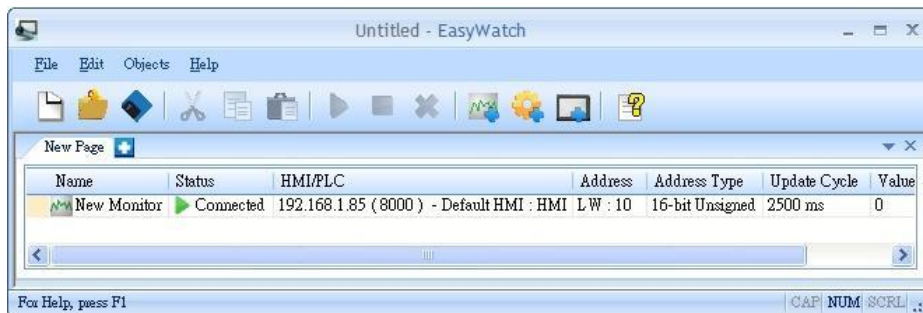
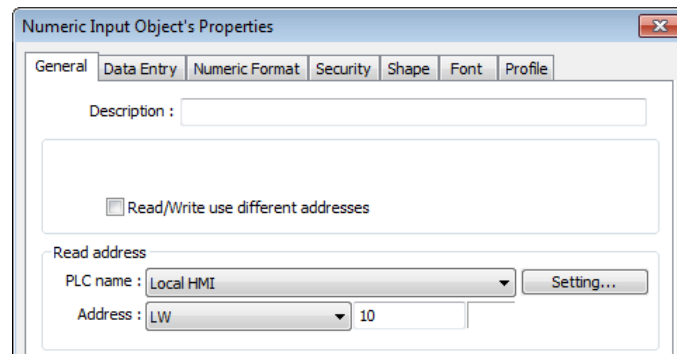

Note

- When the system register [LB-9044 (disable remote control)] or [System Parameter Settings] » [System Setting] » [Prohibit remote HMI connecting to this machine] is enabled, the feature of monitoring in EasyWatch will be unavailable.

35.2. Configuration









35.2.1. Basic Functions





Item	Description
File	<p>New: Opens a new EasyWatch file.</p> <p>Open: Opens an existing EasyWatch file.</p> <p>Save: Saves an EasyWatch file.</p> <p>Save As: Saves an EasyWatch file to .ewt format.</p>

	Exit: Exits EasyWatch.
Edit	Cut: Relocates the selected items to the clipboard. Copy: Copies the selected items to the clipboard. Paste: Pastes the items in the clipboard at the selected location.
Objects	Add Object: Adds new Monitor or Macro objects. Delete Objects: Selects the objects to be deleted, a dialog box appears, click [Yes] to delete. Modify Object: Changes the settings of the selected object. HMI Manager: Adds, modifies, or removes HMI settings. Run: Executes the selected object. Stop: Stops executing the selected object.
Help	Help Topics: Reference of how to operate EasyWatch. About EasyWatch: EasyWatch version information.

35.2.2. Quick Selection Tools



Item	Description
 New	Opens a new EasyWatch file.
 Open	Opens an existing EasyWatch file.
 Save	Saves an EasyWatch file.
 Cut	Relocates the selected items to the clipboard.
 Copy	Copies the selected items to the clipboard.
 Paste	Pastes the items in the clipboard at the selected location.
 Run	Executes the selected object.
 Stop	Stops executing the selected object.

	Delete	Deletes the selected object.
	Add Monitor	Adds a new address monitor.
	Add Marco	Adds a new macro.
	HMI	Opens HMI Manager to add, modify, or remove HMI settings.
	Help Topics	Reference of how to operate the EasyWatch.

35.3. Monitor Settings

35.3.1. Adding a Monitor

There are two ways to create a Monitor Object.

- Select from the toolbar: [Objects] » [Add Object] » [Add Monitor].
- Select from the quick selection toolbar: [Add new address monitor].

35.3.2. Monitor Settings

Setting	Description
Name	Enters an object name which is an unique name. Read Only: If an object is set to read only, its address value can't be edited.

HMI	Select a HMI to monitor.
PLC	Selects the desired PLC to monitor and sets its type, station number, and connection method.
Address	Selects the desired object address to monitor and sets its address type.
Address Type	When the address type is set, the available formats of the address can be selected. When executing, the address will be displayed according to the selected format.
Update Cycle	Sets the update interval of the monitoring object. If many objects are executed simultaneously, the errors or delays may appear.

35.3.3. Steps to Add a New Monitor

1. Select a target HMI. If the target HMI does not exist, click [Open HMI Manager] and click [Add] to search the HMI for adding.

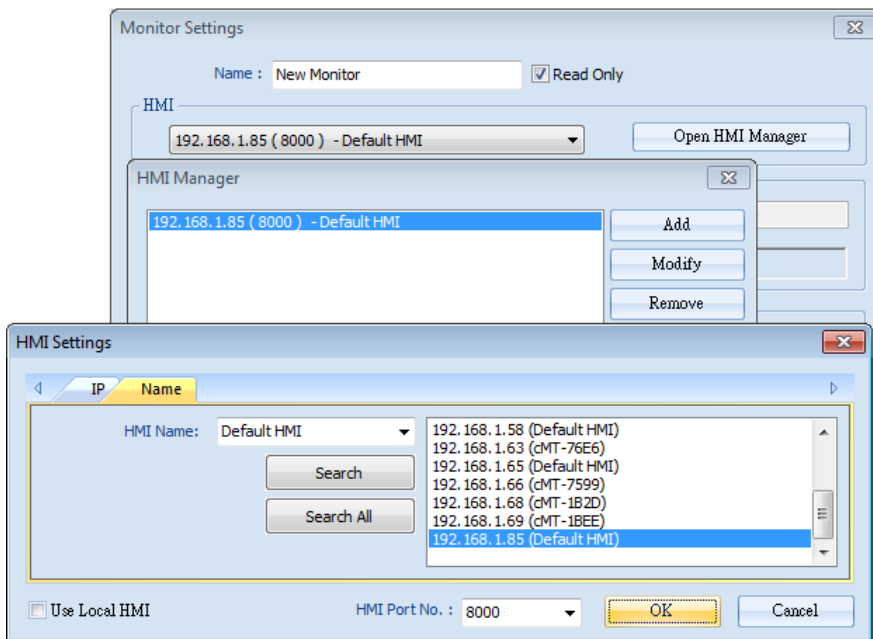

Or, select [Use Local HMI] checkbox to use the project on PC as a monitoring device.

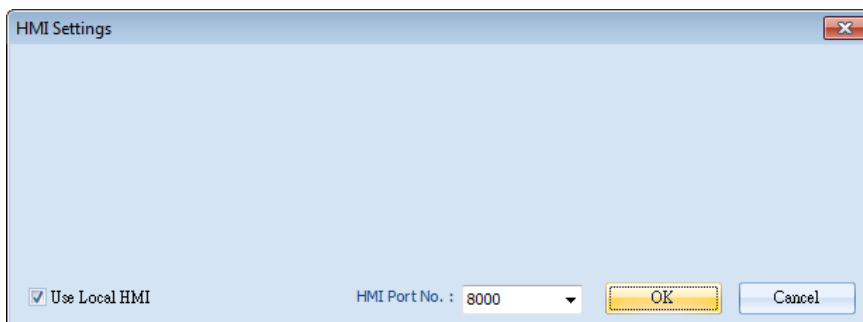

2. Select a target HMI or PLC. If one HMI is selected, you can directly control the local HMI.

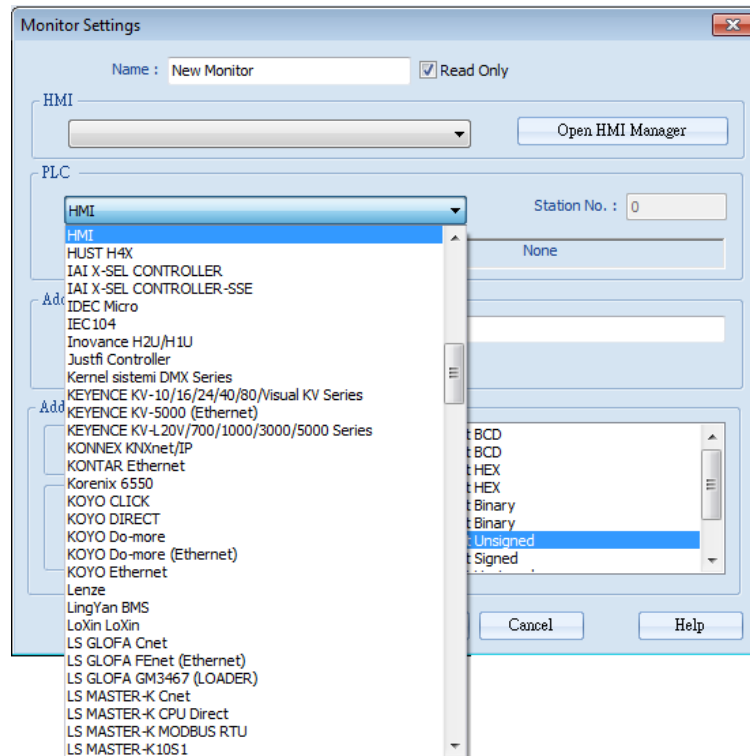

If one PLC is selected, click [I/F Setting] and select [Com Port] to choose a COM port.

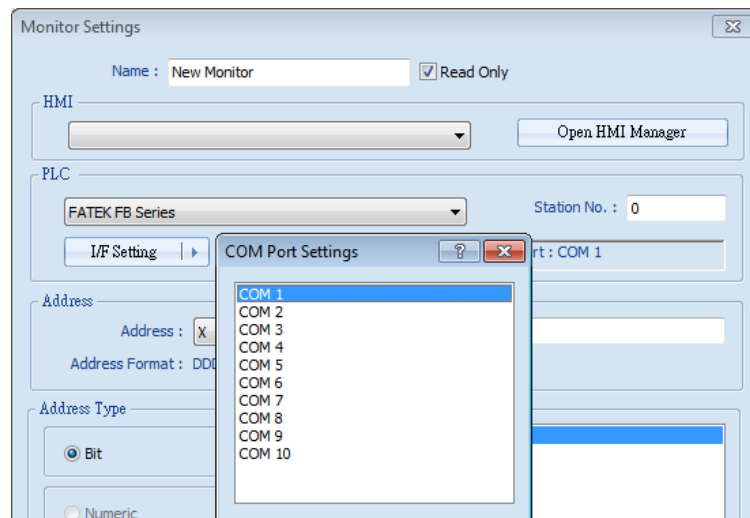

Or, click [I/F Setting] and select [Ethernet] to set the IP address.

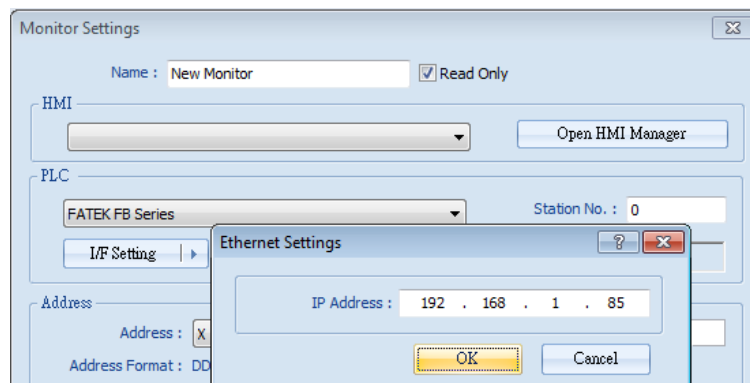

3. Set the object address and its address type for being monitored.

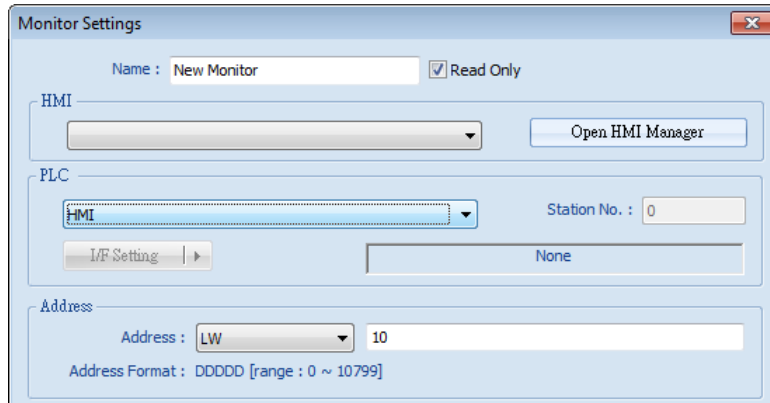

- When a Word address is selected, set the address type to [Numeric] or [String].
[Numeric]: Select the data format of the monitor address.

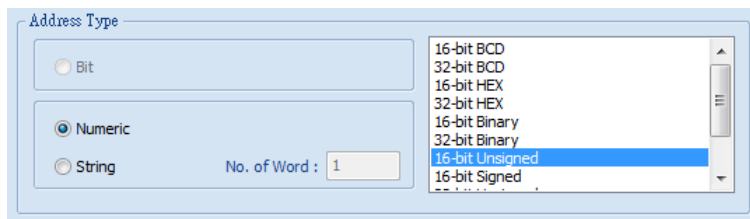

[String]: Select the data format from [ANSI], [UNICODE], and [High/Reversed]. Set [No. of Word] for reading the number of WORD.

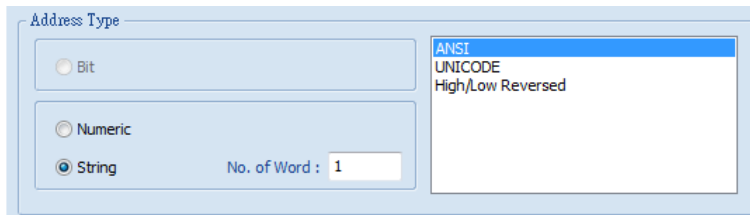

- Set the update interval of the monitor object. The range can be set from 500ms to 5000ms.

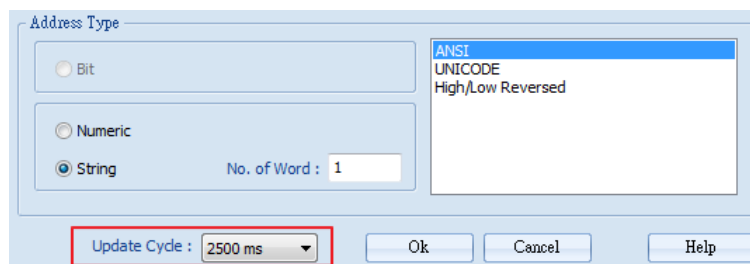

35.4. Macro Settings

35.4.1. Adding a Macro

There are two ways to create a Macro object.

- Select from the toolbar: [Objects] » [Add Object] » [Add Macro].
- Select from the quick selection toolbar: [Add new macro].

35.4.2. Macro Settings

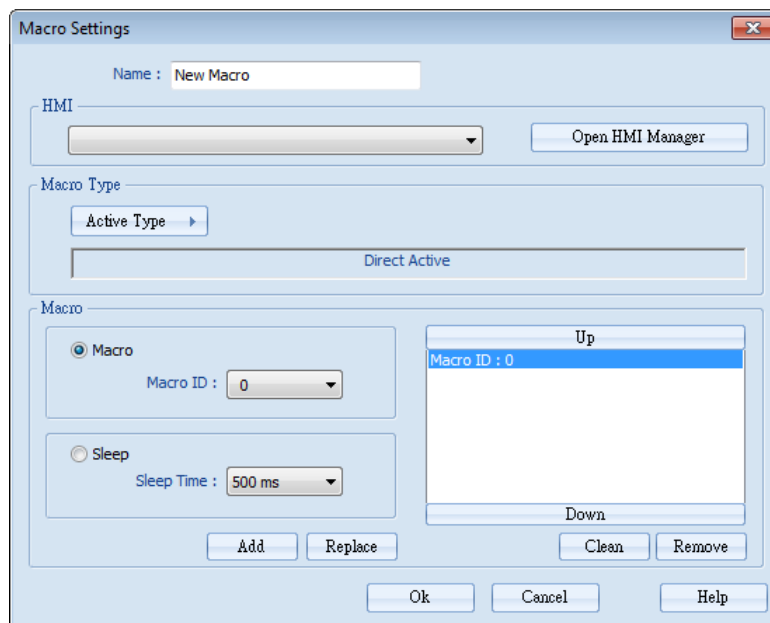

Setting	Description
Name	Enters an object name which is an unique name.
HMI	Selects a HMI to monitor.
Macro Type	The ways to execute the Macro included Direct Active and Cycle Active.
Macro	Each Macro Object can execute multiple macros. The time interval between the executions of two macros can be changed.

35.4.3. Steps to Add a New Macro

1. Select a target HMI. If the target HMI does not exist, add a new device, see “35.3.3 Steps to Add a New Monitor”.
2. Set Active Type under Macro Type to [Direct Active] or [Cycle Active].
 [Direct Active]: Directly executes Macro once.
 [Cycle Active]: Set the interval of executing Macro.

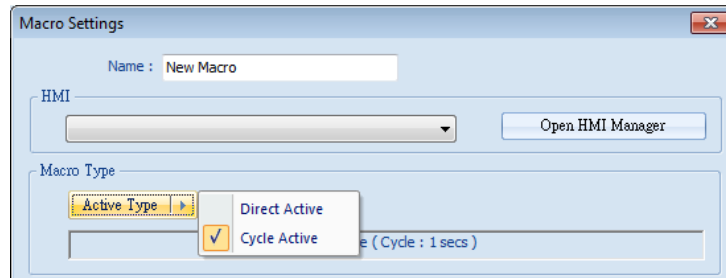

For example, if [Cycle Active] is set to 5 seconds, when executing a macro, the next time to execute the macro object will be 5 seconds later.

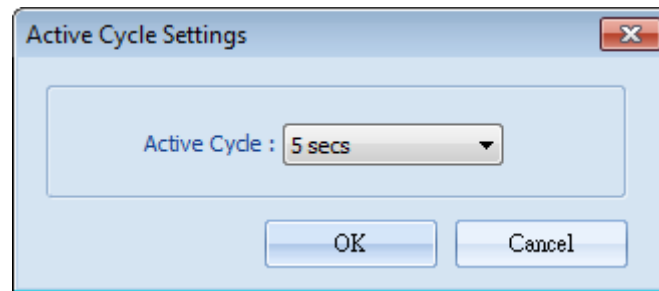

3. Set Macro to [Macro] or [Sleep].

[Macro]: Select the Macro ID for execution, and click [Add] to add the Macro to the list.

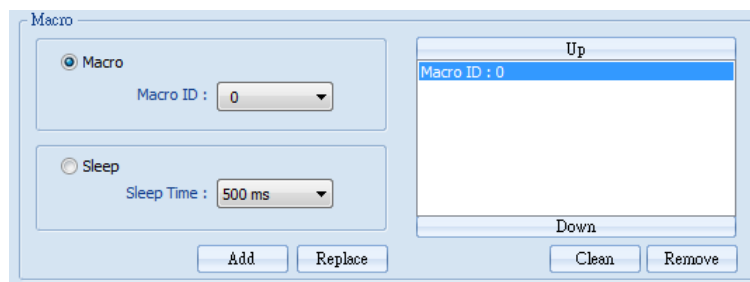

[Sleep]: Set the time interval between the executions of two Macros. Click [Add] or [Replace] to add or replace the Macros from the list.

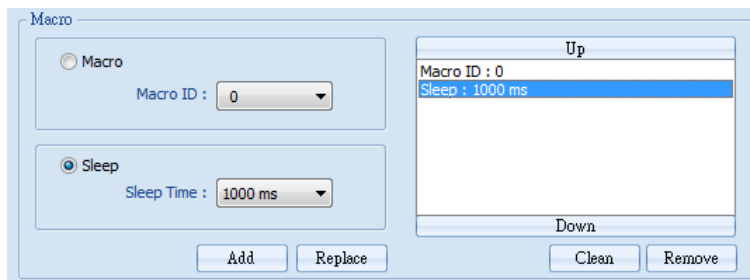

35.5. HMI Manager

35.5.1. Opening HMI Setting

There are two ways to open the HMI Setting.

- Select from the toolbar: [Objects] » [HMI Manager].
- Select from the quick selection toolbar: [Open HMI manager].

35.5.2. HMI Manager

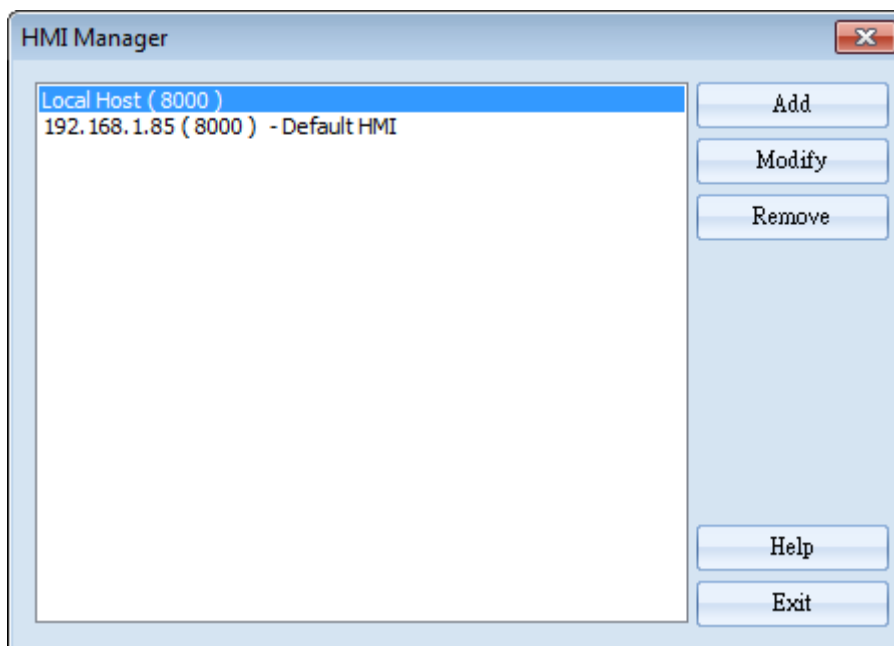

Setting	Description
Add	Select a target HMI. If the target HMI does not exist, add a new device, see "35.3.3 Steps to add a new monitor".
Modify	Modify the settings of the HMI.
Remove	Remove the HMI.

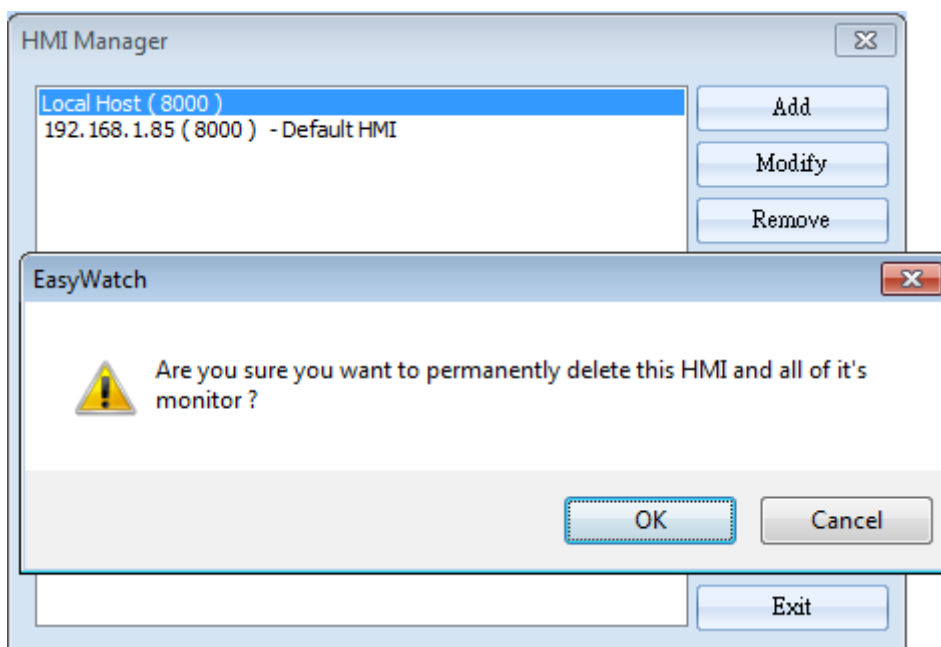

35.6. Object List

35.6.1. Object List Columns

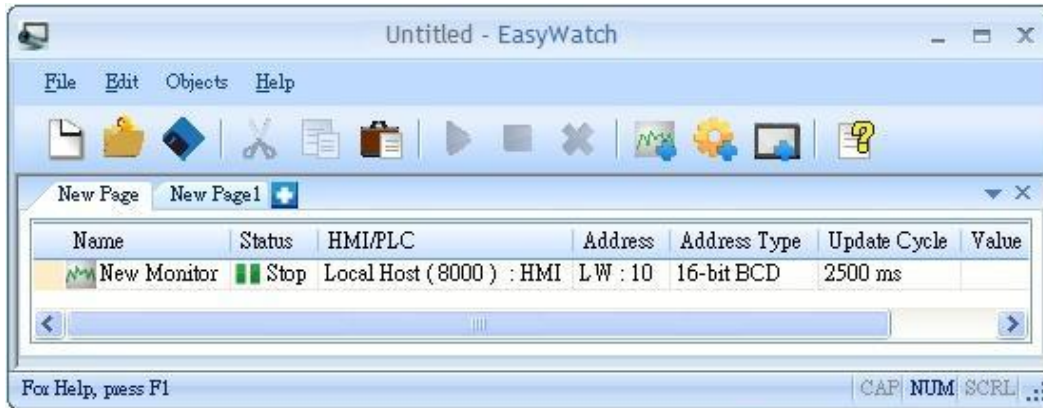

Setting	Description
Name	Displays the object name. The small icons of the names are for users to identify the objects.
Status	Displays the status of the objects: [Connecting], [Connected], and [Stop]. If HMI is not connected or Port No. is incorrect, the error message "HMI Not Found" will appear. For Monitor Objects, if the address is incorrect, "Address Error" message will appear.
HMI / PLC	Displays the information of HMI / PLC that is currently operated by the objects.
Address Address Type	For Monitor Objects, the relevant address setting is displayed.
Update Cycle	Set the update interval of the monitor object.
Value	For Monitor Object, if the status shows [Connected], the current HMI address value will be displayed. Modifying the value is also available when the Read-Only checkbox is unselected. For Macro Object, if set to [Direct Active], there will be an [Active] button in this column for clicking to directly execute a macro.

35.6.2. Editing Object List

- Adding a new page: Click the icon to add a new page.

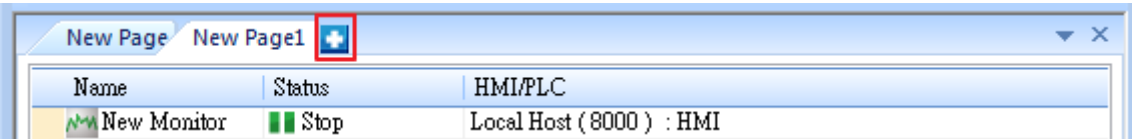

- Deleting a page: Click the icon and confirm the deletion.

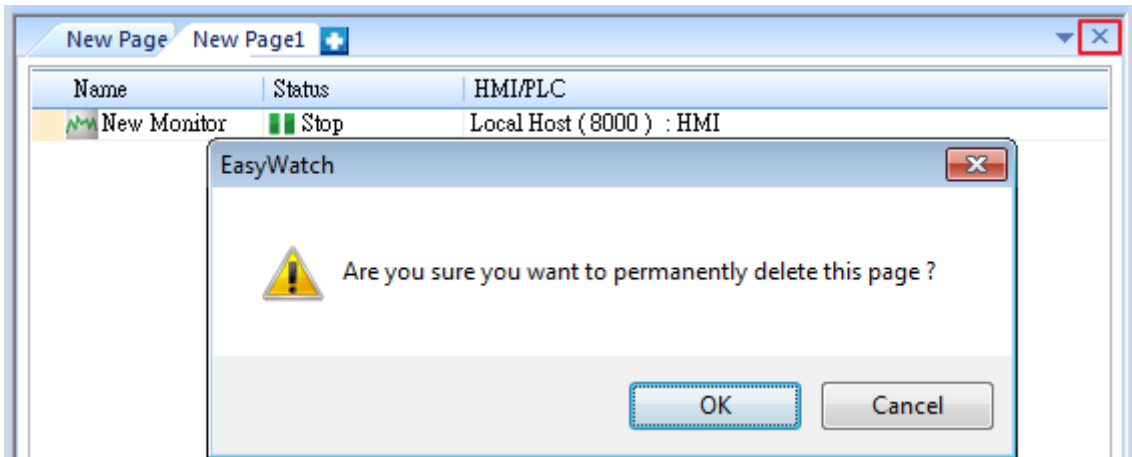

- Renaming the page: Double-click on the page name and enter a new name.

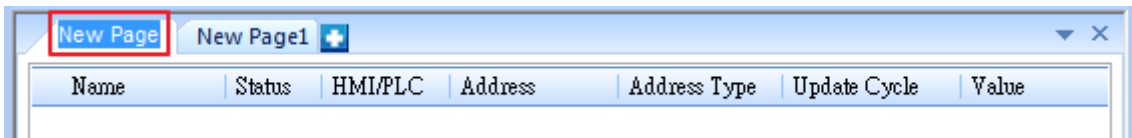

- Positioning the column headers: Drag and drop the column headers to the desired location.

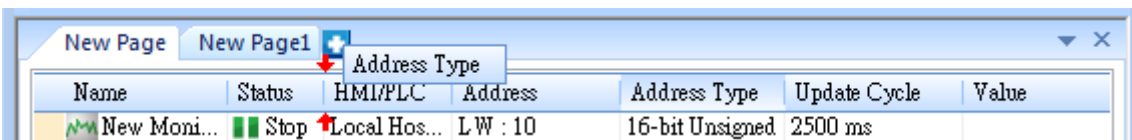

36. Administrator Tools

This chapter explains how to setup Administrator Tools.

36.1. Overview.....	36-2
36.2. User Accounts.....	36-2
36.3. USB Security Key.....	36-6
36.4. e-Mail SMTP Server Settings	36-9
36.5. e-Mail Contacts.....	36-10

36.1. Overview

Administrator Tools allows storing the data of [User Accounts], [USB Security Key], [e-Mail SMTP Server Settings], and [e-Mail Contacts] to USB. With EasyBuilder Pro user accounts and e-Mail function, the data built can be imported to HMI by Function Key object set to “Import user data / Use [USB Security Key]”. The portability and convenience is greatly improved. Launch Administrator Tools, select the check boxes in [Save] column to enable the selected functions introduced in this chapter.

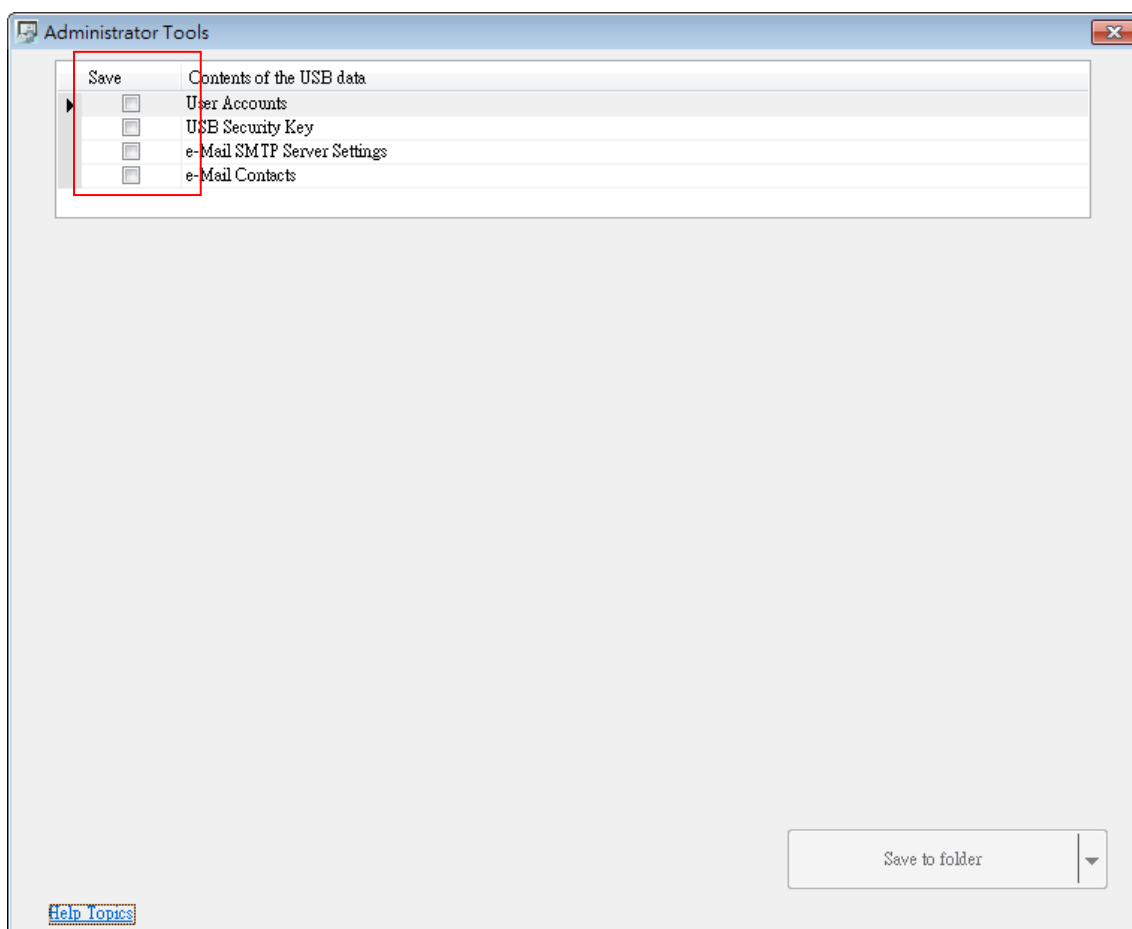

36.2. User Accounts

36.2.1. User Accounts Settings

Select [User Accounts] check box and complete the relevant settings.

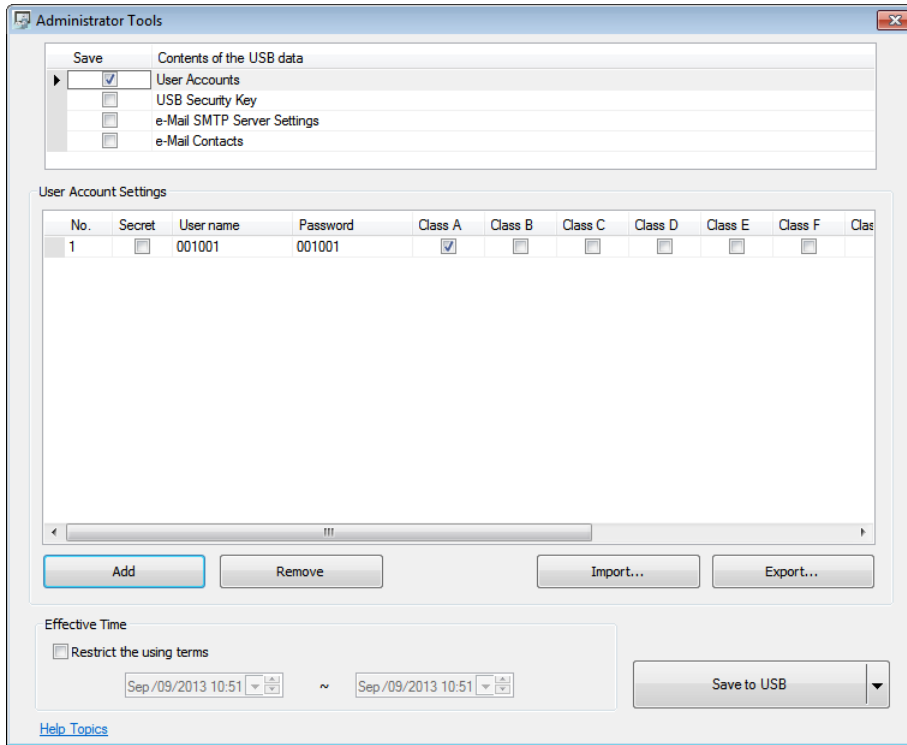

Settings	Description
Secret	Select the check box to set secret accounts.
User Name	Sets User Name. *Note 1
Password	Sets User Password. *Note 1
Class A to L	Sets user privilege.
Add	Adds a new account. *Note 2
Remove	Deletes an existing account.
Import	Imports user account data.
Export	Exports user account data.
Effective Time	If [Restrict the using terms] is not selected, it is available to import data anytime. If select [Restrict the using terms] check box, and set an effective time period, the importing of data to HMI can only be done in the time limit specified. When time expired, data cannot be imported, please reset the data with this tool again.
Save to USB	Saves data to USB. To save to a specific folder, click “▼” button and select “Folder”.

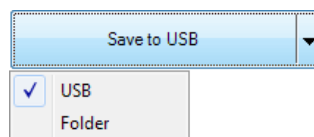

 **Note**

1. Only allows letters, numbers, “-” or “_”, case-sensitive.
2. A maximum of 127 user accounts can be added.

36.2.2. Steps to Set User Accounts

1. Click [Add] to create a new account. Click [Remove] to delete the selected account. Select [Secret] check box to define the account as a secret user. Type in [User name] and [Password] and check the privilege from [Class A] to [Class L] check boxes.

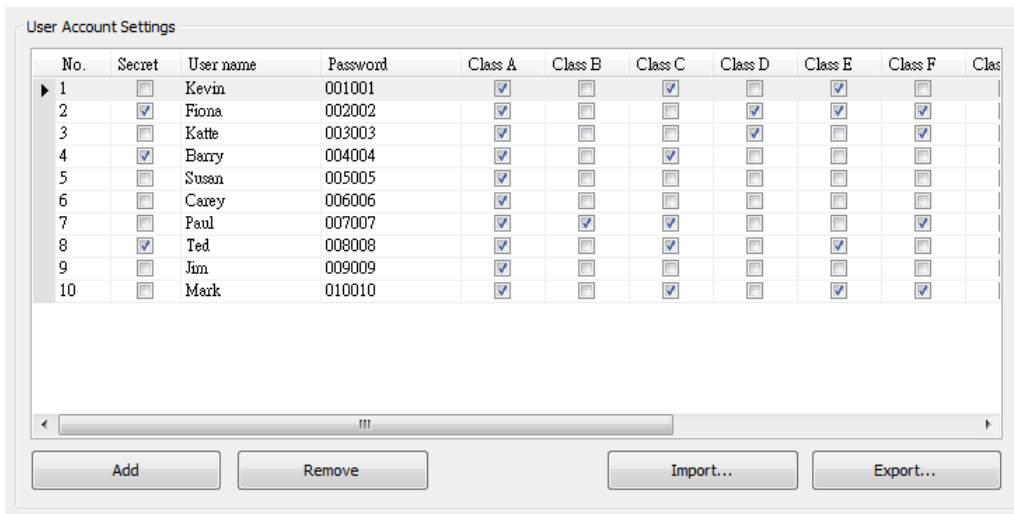

2. To back up the data, click [Export]. Click [Use Password] to protect the data, next time when click [Import] to import the backup data, a password is required.

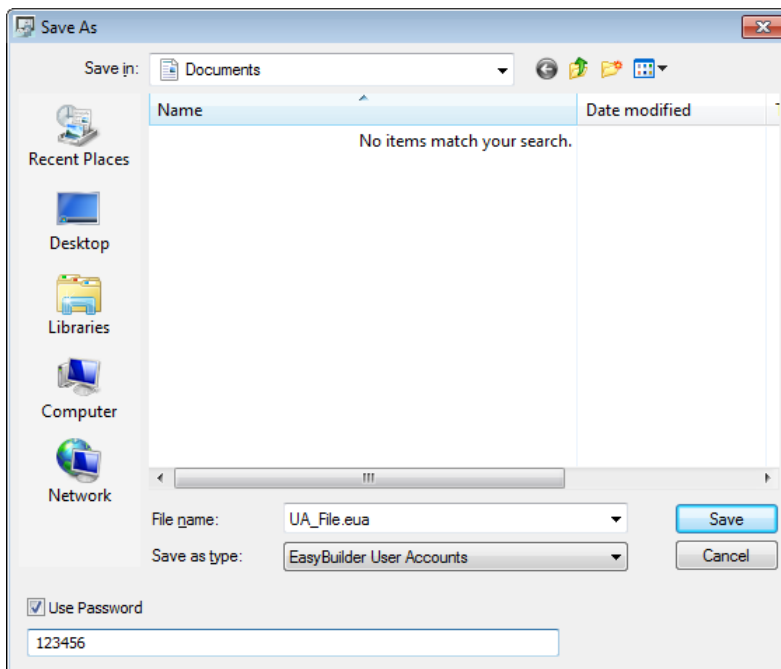

3. If under [Effective Time], the [Restrict the using terms] check box is selected, only during the specified time period can the users import account data to HMI. If not selected, users

can import data to HMI at any time.

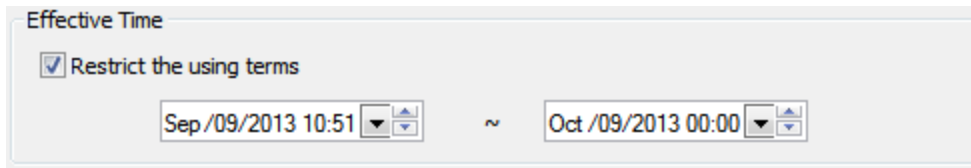

4. When finished, click [Save to USB], select the location of USB and then click [Create]. If successful, the “Generated successfully!” message is shown.

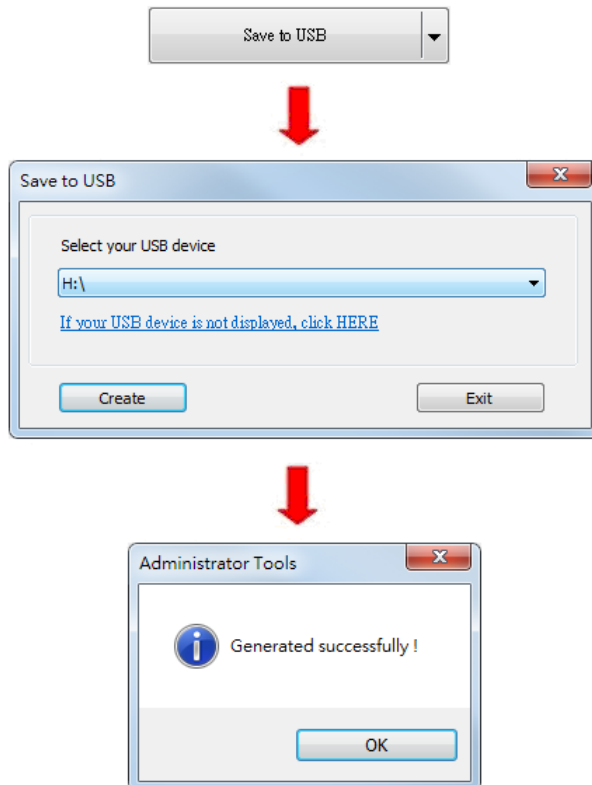

36.2.3. Steps to Import Accounts Using EasyBuilder Pro

The following steps explain how to create a Function Key to import data in EasyBuilder Pro.

1. Select “Import user data/Use [USB Security Key]” in Function Key setting dialog box, and then click [Settings].

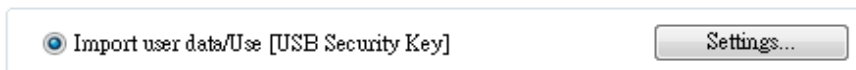

2. Under [Function mode] select [Import user accounts]. Select the device that stores the data in [Data position]. Select [Overwrite] under [Account import mode]; HMI will only store the account data imported this time. Select [Append], HMI will store the accounts imported this time and those already exist. Select [Delete file after importing user accounts] check box to delete the source files after importing.

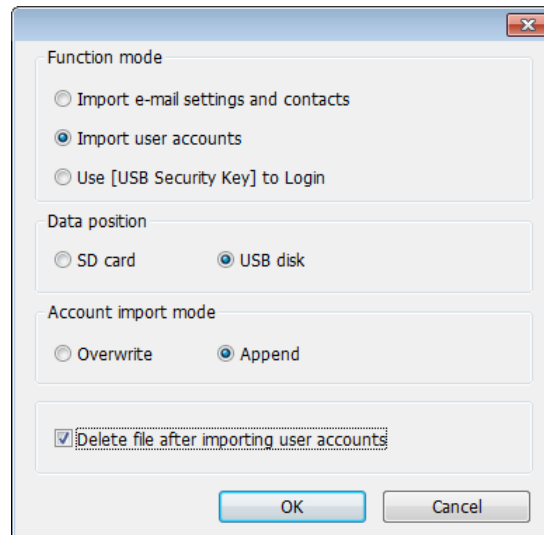

 Click the icon to download the demo project that explains how to import user accounts by using Function Key. Please confirm your internet connection.

36.3. USB Security Key

36.3.1. USB Security Key Settings

With the predefined user login information, the USB Security Key can be used to log in directly.

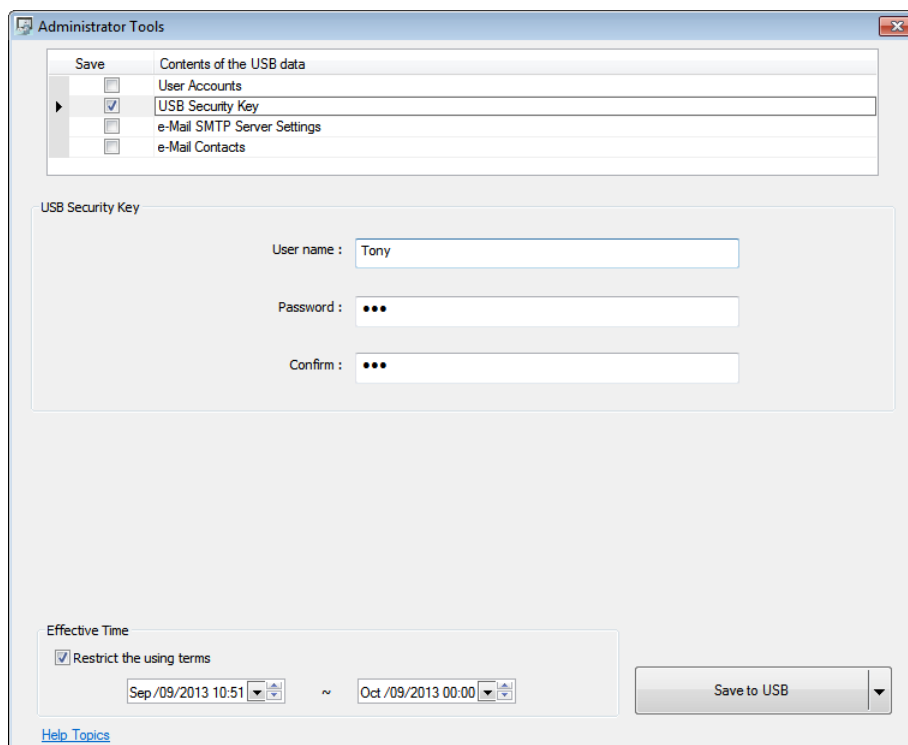

Settings	Description
User Name	Sets User Name. *Note 1
Password	Sets User Password. *Note 1
Confirm	Confirms User Password.
Effective Time	Logs in using USB Security Key during the specified time period. If not specifying Effective Time, log in at any time.
Save to USB	Saves data to USB.

Note

1. Only allows letters, numbers, "-" or "_", case-sensitive.

36.3.2. Steps to Set USB Security Key

1. Type in the existing user name and password. Type the password again in [Confirm] field for password confirmation.



USB Security Key

User name : Tony

Password : ●●●

Confirm : ●●●

2. Under [Effective Time] if [Restrict the using terms] check box is selected, only during the specified time period can users log in using USB Security Key. If not selected, users can log in using USB Security Key at any time.

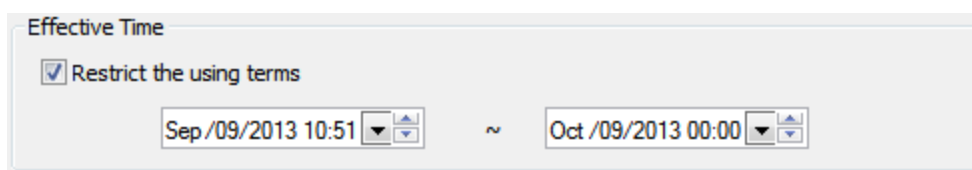

Effective Time

Restrict the using terms

Sep/09/2013 10:51 ~ Oct/09/2013 00:00

3. When finished, click [**Save to USB**], select the location of USB and then click [**Create**]. If successful, the "Generated successfully!" message is shown.

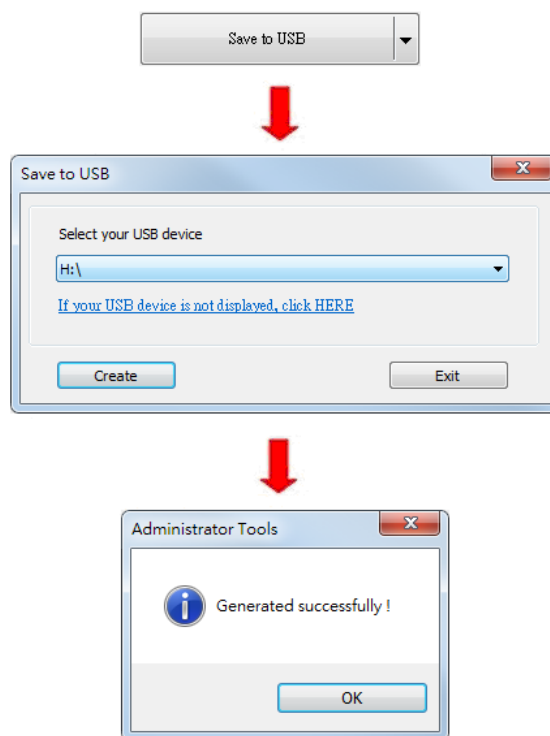

36.3.3. Steps to Set USB Security Key Using EasyBuilder Pro

The following steps explain how to create a Function Key to enable USB Security Key in EasyBuilder Pro. By touching the object, the USB Security Key is enabled for login.

1. Select "Import user data/Use [USB Security Key]" in Function Key setting dialog box, and then click [Settings].

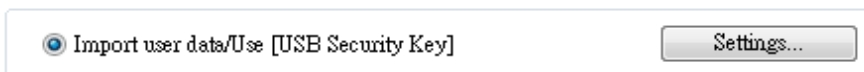

2. Under [Function mode] select [Use USB Security Key to Login]. Select the device that stores the data in [Data position].

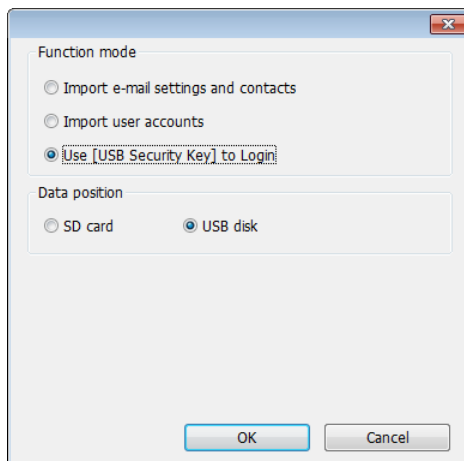

 Click the icon to download the demo project that explains how to enable login using USB Security Key by using Function Key. Please confirm your internet connection.

36.4. e-Mail SMTP Server Settings

Select [e-Mail SMTP Server Settings] check box to complete the relevant settings.

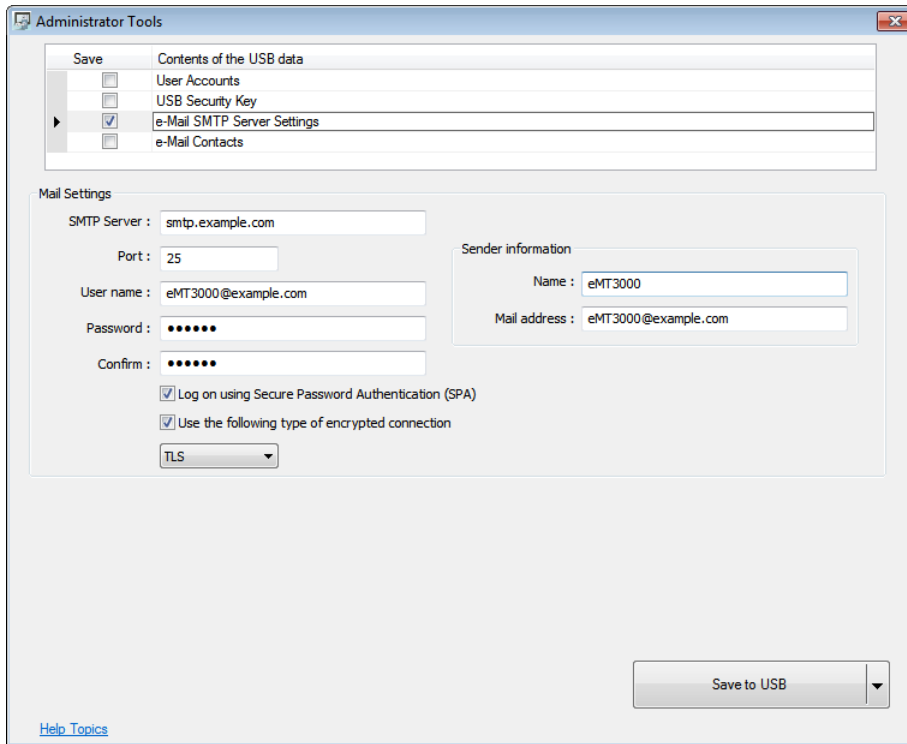

Mail Settings	Description
SMTP Server	Specifies SMTP Server.
Port	Specifies SMTP Server port number.
User name	User e-mail account name.
Password	User e-mail account password.
Confirm	Confirm user e-mail account password.
Sender Information	Description
Name	The sender name displayed when mail received.
Mail address	The sender address displayed when mail received.
Save to USB	Saves data to USB.

36.4.1. Steps to set e-Mail SMTP Server Settings

1. Set the settings as shown in the following figure.

The Mail Settings dialog box contains the following fields and options:

- SMTP Server : smtp.example.com
- Port : 25
- User name : eMT3000@example.com
- Password : [masked]
- Confirm : [masked]
- Log on using Secure Password Authentication (SPA)
- Use the following type of encrypted connection
- Encrypted connection type: TLS
- Sender information section:
 - Name : eMT3000
 - Mail address : eMT3000@example.com

- When finished, click [Save to USB], select the location of USB and then click [Create]. If successful, the “Generated successfully!” message is shown.

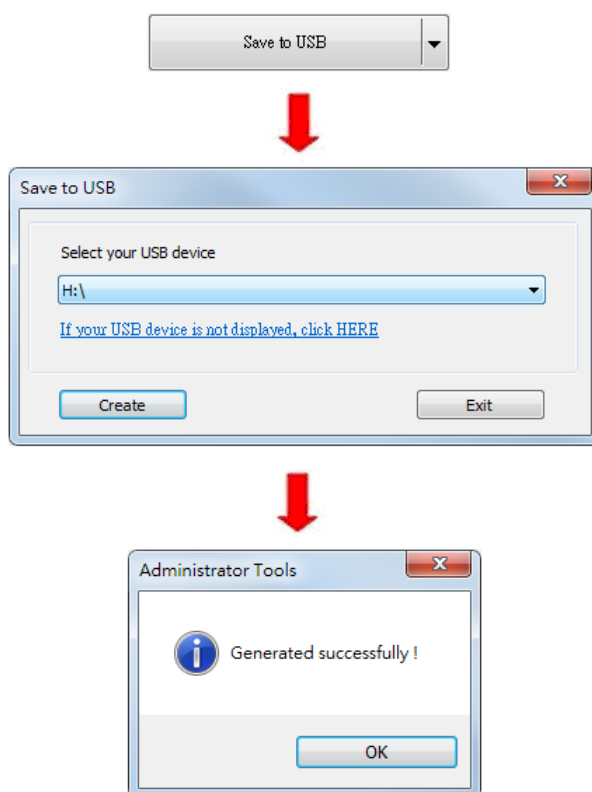

36.5. e-Mail Contacts

36.5.1. e-Mail Contacts Settings

Select [e-Mail Contacts] check box to complete the relevant settings.

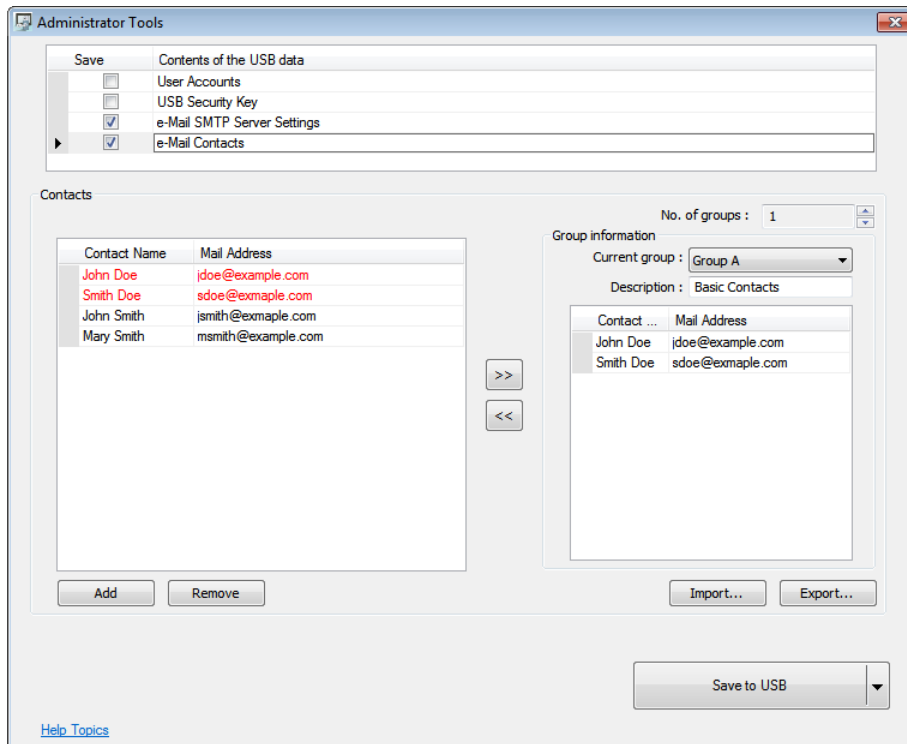

Settings	Description
Add	Adds a new contact. *Note1
Remove	Removes a contact.
No. of groups	The number of groups. *Note2
Current group	The name of current group. *Note3
Description	Group description.
Import	Imports contact information.
Export	Exports contact information.
Save to USB	Saves data to USB.

Note

1. A maximum of 256 contacts can be added.
2. A maximum of 16 groups can be added. (Group A to Group P)
3. From Group A to P, when [No. of groups] is “1”, only Group A will exist, when added to “2”, Group A and Group B will exist, and so on.
4. UTF-8 characters are allowed in contact names.

36.5.2. Steps to set e-Mail Contacts

1. Click [Add] to add in all contacts.
2. Add the contacts to Group A, the added contacts are displayed in red font.

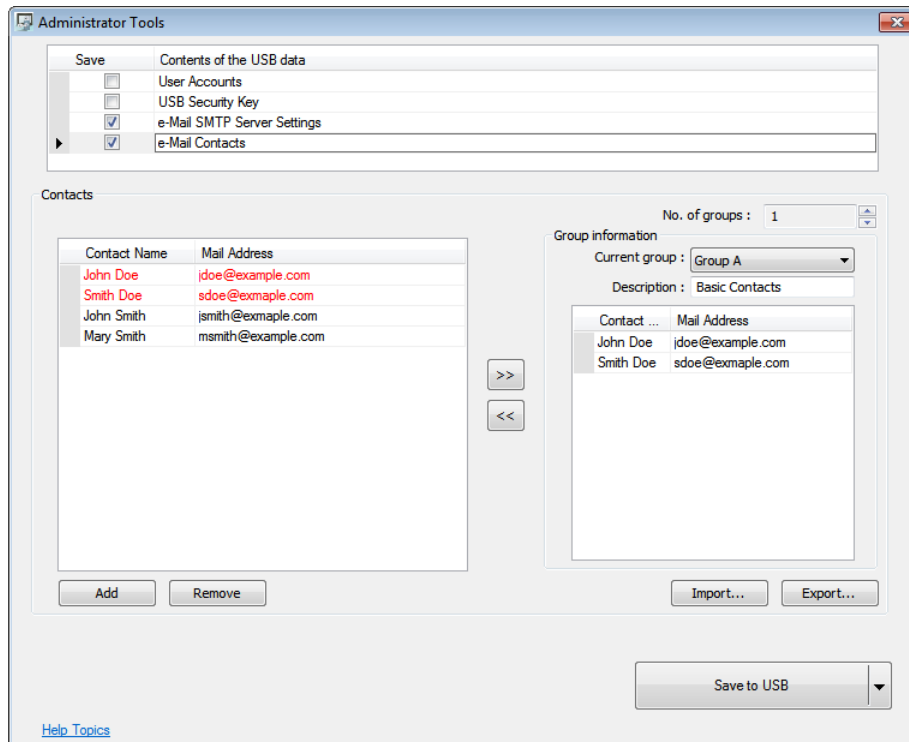

3. Press the up or down arrows of the spin box of [No. of groups] to add new groups. If add to "2", Group B can be found. Repeat step 1 and step 2 to add contacts into groups.

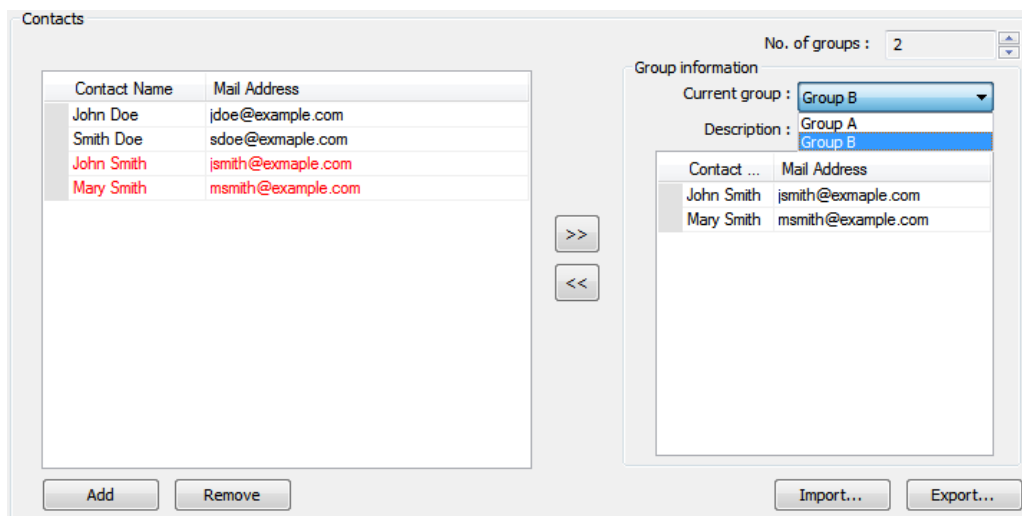

4. After adding all the e-mail contacts, click [Export] to back up the data for future use and modification. Next time when needed, click [Import] to import the backup data.
5. When finished, click [Save to USB], select the location of USB and then click [Create]. If successful, the "Generated successfully!" message is shown.

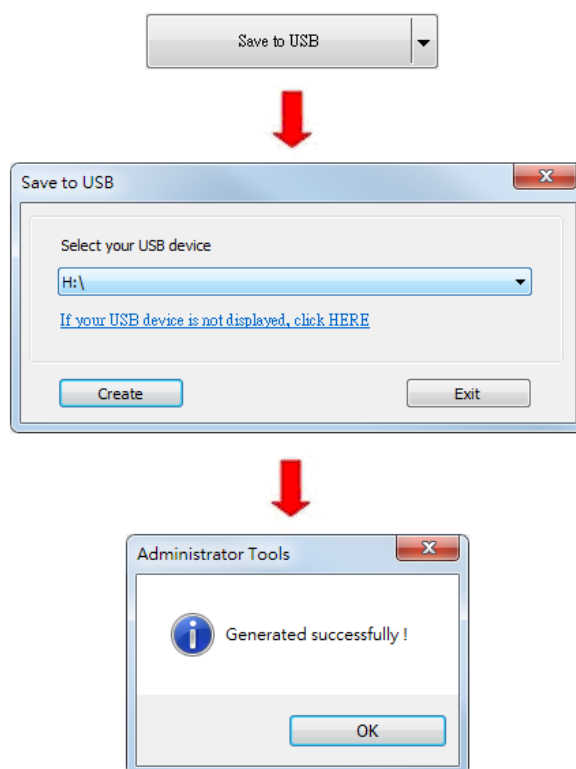

36.5.3. Steps to Import e-Mail Settings and Contacts Using EasyBuilder Pro

The following steps explain how to create a Function Key to import e-Mail contacts.

1. Select “Import user data/Use [USB Security Key]” in Function Key setting dialog box, and then click [Settings].
2. Under [Function mode] select [Import e-mail settings and contacts]. Select the device that stores the data in [Data position].

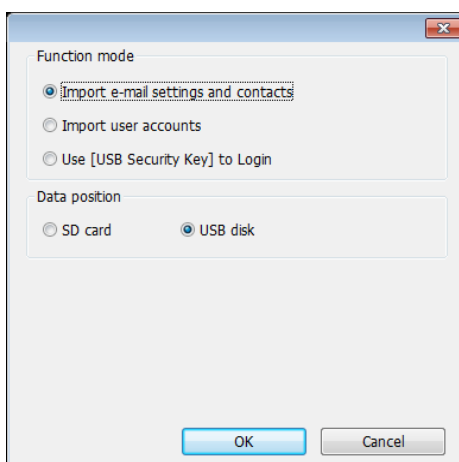

Click the icon to download the demo project that explains how to import e-mail settings and contacts by using Function Key. Please confirm your internet connection.

37. MODBUS TCP/IP Gateway

This chapter explains how to use MODBUS TCP/IP Gateway and configure address mapping tables.

37.1. Overview.....	37-2
37.2. Steps to Create an Address Mapping Table.....	37-2
37.3. Notes about Configuring Address Mapping	37-5

37.1. Overview

To access the data of the PLC connected to HMI with SCADA software (Supervisory Control and Data Acquisition), the former way was to transfer PLC data to the HMI's local address first, and then use MODBUS TCP/IP protocol on PC to read HMI local address to get PLC data. Now by using MODBUS TCP/IP Gateway provided by EasyBuilder, the mapping of MODBUS address to PLC address can be defined first, and then one can directly use MODBUS TCP/IP protocol to access PLC data.



37.2. Steps to Create an Address Mapping Table

To create an Address Mapping Table, please follow the steps:

1. In [System Parameter Settings] » [Device] tab, add the PLC device. (In the example FATEK FB Series is used).
2. Add MODBUS Server (Ethernet), select [Enable] check box under [MODBUS TCP/IP Gateway] as shown in the following figure.

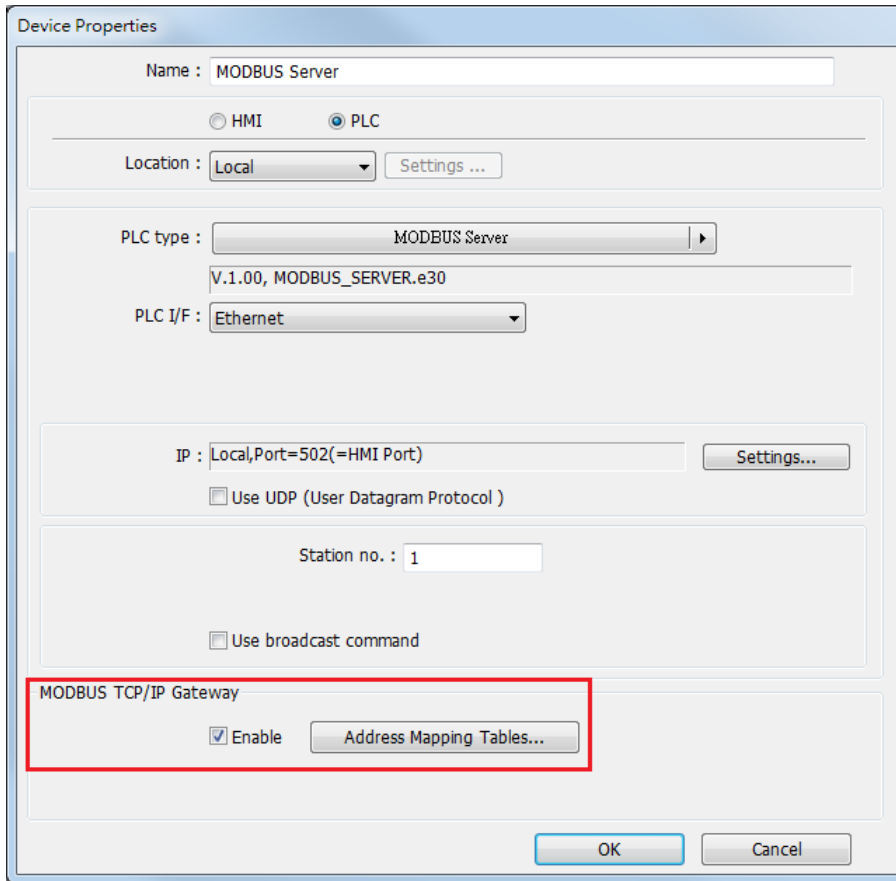

- Click [Address Mapping Tables] button and the following default tables will be displayed. Modify the tables if needed or add new tables.

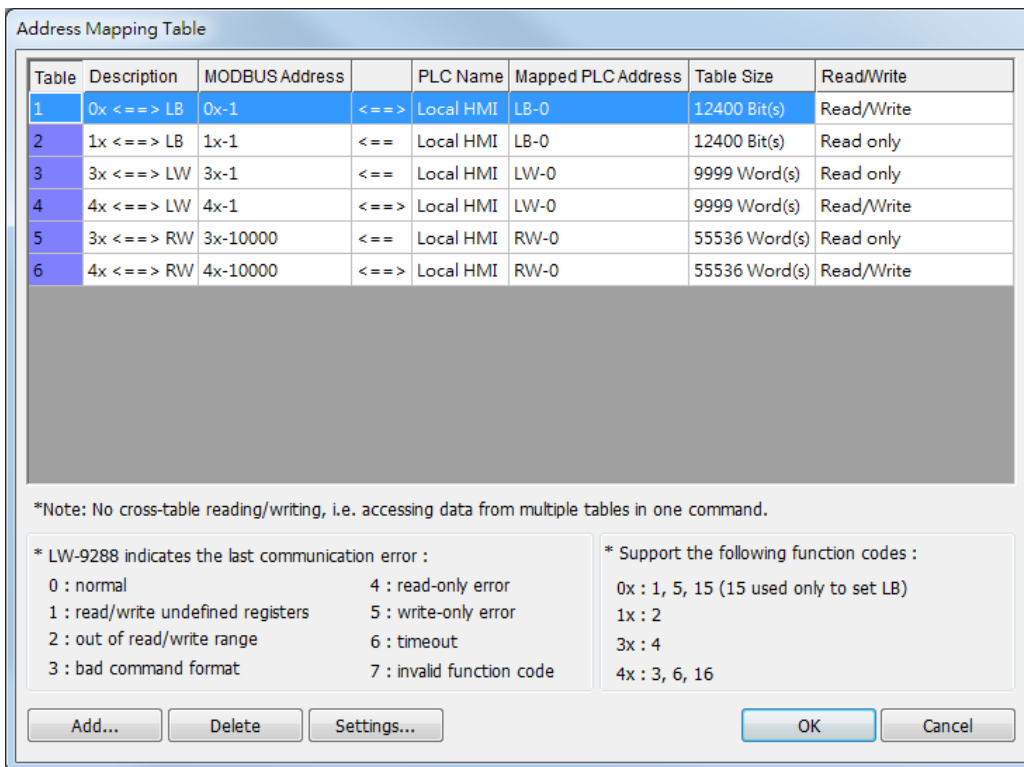

- For example, to access the data in the 50 consecutive registers of FATEK FB Series PLC starting from register D-0, configure the settings as shown in the following figure.

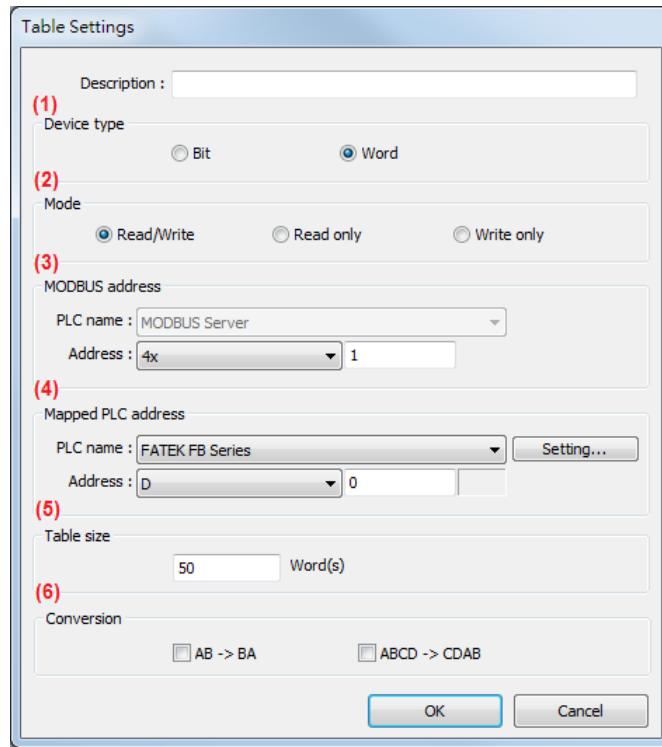

- Select the device type of the registers to be mapped, in the example select [Word].
- Select the mode to access the data in the mapped register, in the example set to [Read/Write].
- Set the start address of MODBUS, in the example set to “4x-1”.
- Set the start address of the mapped PLC, in the example set to “D-0”.
- Set the range size of address mapping, in the example set to “50”.
- If needed, select high/low byte swap (AB->BA) or high/low word swap (ABCD->CDAB).

Table	Description	MODBUS Address		PLC Name	Mapped PLC Address	Table Size	Read/Write
1	Access D0 ~ D49	4x-1	< == >	FATEK FB Series	D-0	50 Word(s)	Read/Write

The above figure shows that MODBUS Server 4x-1 ~ 4x-50 registers are mapped to FATEK FB Series PLC D-0 ~ D-49 registers.

- When finished, the data of FATEK FB Series PLC D-0 ~ D-49 registers are now accessible by using MODBUS TCP/IP protocol to send read / write command to 4x-1 ~ 4x-50 registers.

37.3. Notes about Configuring Address Mapping

- UDP is not supported when using the MODBUS TCP/IP Gateway feature.
- This feature is only supported by MODBUS Server (Ethernet) interface.
- System register LW-9288 is used to indicate if data transfer has been correctly executed.

The following error codes represent:

Value	Definition
0	Normal
1	Read or write the register that is not defined in the Address Mapping Table.
2	Read or write a range of registers that is not within the range defined in a single Address Mapping Table. (Or, read / write a register that is defined in other Address Mapping Table.)
3	The command format does not follow MODBUS TCP/IP protocol.
4	Modify a read-only register.
5	Read a write-only register.
6	Cannot get the correct reply from PLC within the specified time range.
7	Use a function code that is not supported by MODBUS Server.

- The defined register range must not overlap between different mapping tables.
- If [MODBUS TCP/IP Gateway] is enabled, EasyBuilder will cancel the original mapping between MODBUS Server and HMI register. That includes:

- (1) 0x, 1x mapped to LB
- (2) 3x, 4x mapped to LW, RW

Therefore, to access data in LB or LW register via 0x, 1x, 3x, 4x, configure the Address Mapping Table again. The following figure is an example.

Table	Description	MODBUS Address		PLC Name	Mapped PLC Address	Table Size	Read/Write
1	0x <==> LB	0x-1	<==>	Local HMI	LB-0	12400 Bit(s)	Read/Write
2	1x <==> LB	1x-1	<==	Local HMI	LB-0	12400 Bit(s)	Read only
3	3x <==> LW	3x-1	<==	Local HMI	LW-0	9999 Word(s)	Read only
4	4x <==> LW	4x-1	<==>	Local HMI	LW-0	9999 Word(s)	Read/Write
5	3x <==> RW	3x-10000	<==	Local HMI	RW-0	55536 Word(s)	Read only
6	4x <==> RW	4x-10000	<==>	Local HMI	RW-0	55536 Word(s)	Read/Write

- SCADA can only read / write the register defined in one Address Mapping Table at one time, that is, the same MODBUS command cannot access the data in the registers defined in different Address Mapping Tables.

Table	Description	MODBUS Address		PLC Name	Mapped PLC Address	Table Size	Read/Write
1	Access D200 ~ D298	4x-1	<==>	FATEK FB Series	D-200	99 Word(s)	Read/Write
2	Access R0 ~ R99	4x-100	<==>	FATEK FB Series	R-0	100 Word(s)	Read/Write

As shown in the above figure, in Mapping Table 1 set MODBUS 4x-1 to access register D-200, table size 99 words, and in Mapping Table 2 set MODBUS 4x-100 to access register R-0, table size 100 words. If using SCADA to send a command to read from 4x-1 to 4x-199, table size 199 words, since the range spans two different tables, the command will not be accepted by HMI. Instead, access the data with two separate commands (4x-1~4x-99 and 4x-100~4x-199), each reading only from one table as shown in the following figure.

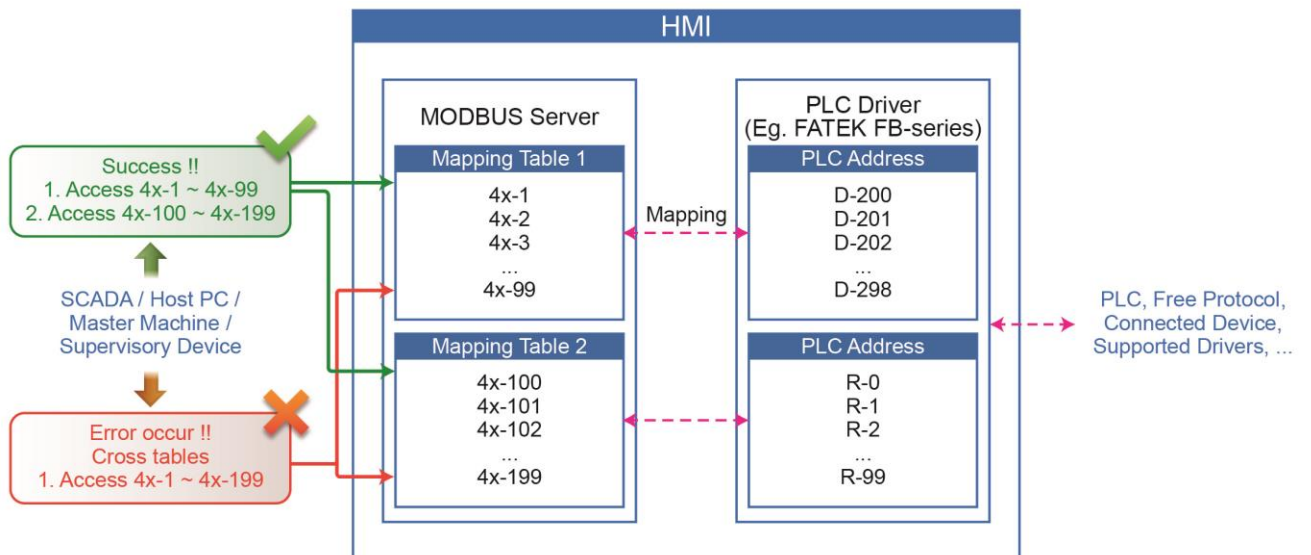

38. EasyDownload

This chapter explains how to setup EasyDownload.

38.1. Overview.....	38-2
38.2. Configuration	38-2

38.1. Overview

EasyDownload allows downloading the project data file built in EasyBuilder Pro via Ethernet or USB cable. In EasyBuilder Pro main menu select [Tools] and then select [Build Data for USB Disk or SD Card Download] to build the data file before running EasyDownload.

38.2. Configuration

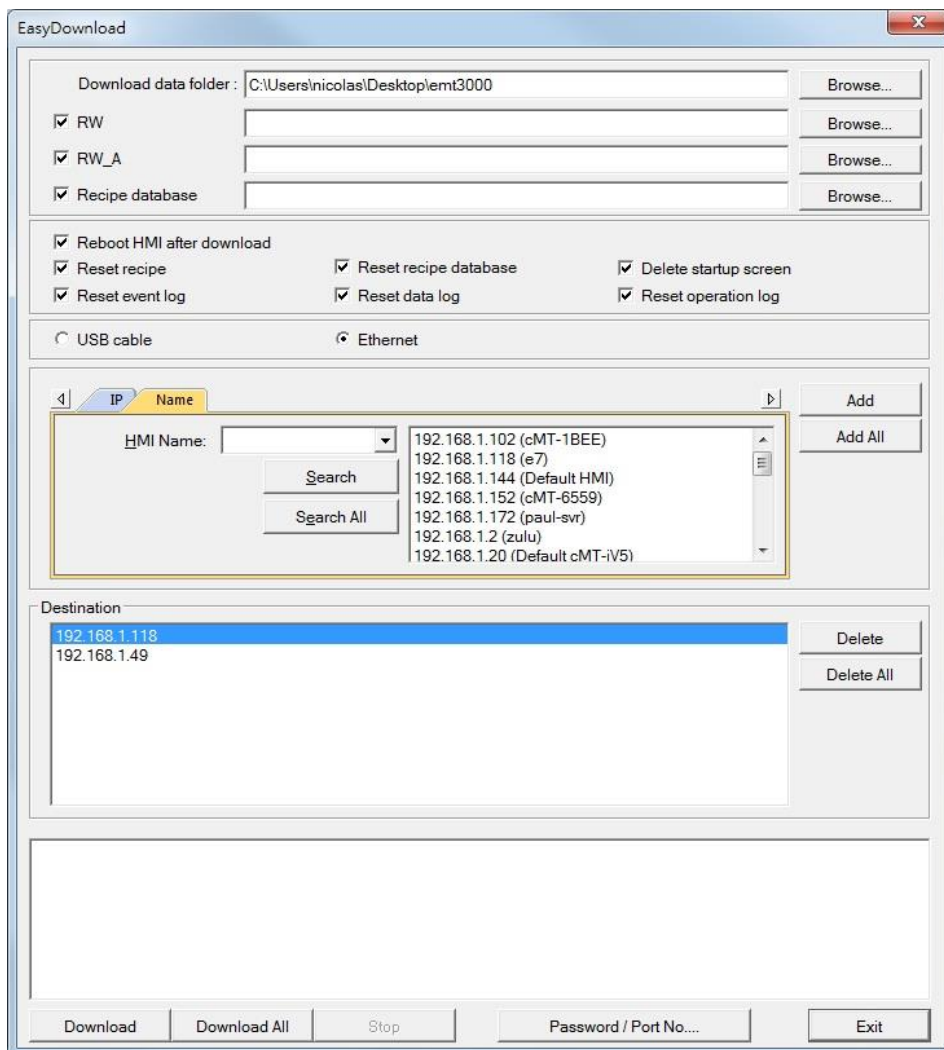

Settings	Description
Download data folder	Browse for the project data file to download.
RW	Browse for the recipe data (.rcp) to download.
RW_A	Browse for the recipe data (.rcp) to download.
Recipe database	Browse for the recipe database (.db) to download.
Reboot HMI after download	If selected, HMI will reboot after downloading.

Reset recipe Reset recipe database Delete startup screen Reset event log Reset data log Reset Operation Log	The selected files will be erased before downloading.
USB cable	Download the file to HMI via USB cable. Please make sure that the USB driver is correctly installed.
Ethernet	Download the file to HMI via Ethernet.
IP	Enter the target HMI IP address.
Name	Enter the target HMI name.
Search	Search by HMI name.
Search All	Search from all the HMI names on the same network.
Add	Add the selected HMI in the Search field to the Destination field.
Add All	Add all the HMI in the Search field to the Destination field.
Destination	A list of all the HMI for download.
Delete	Delete the selected HMI in the Destination field.
Delete All	Delete all the HMI in the Destination field.
Download	Click to start download to the selected HMI in the Destination field.
Download All	Click to start download to all the HMI in the Destination field.
Password / Port No.	Enter the password and the port number of download set in HMI system settings.

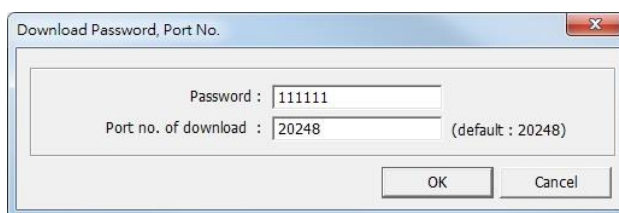

 **Note**

- Take eMT3000 Series as an example, the built download data directory has the following structure. Please select the parent directory of the generated file when download.

Parent directory	First subdirectory	Second subdirectory
emt3000	001	
	002	
	Pub	driver
		font

- The parent directory name changes according to the model used.
- Downloading to multiple HMI is only supported by Ethernet.
- When downloading the project to multiple HMI at a time, all the HMI must use the same password and port number.
- The downloading process goes from the top of Destination list to the bottom. Only when the downloading of one HMI is done will the downloading of next HMI start.
- To avoid long waiting time for an off-line HMI, the wait time is 3 seconds.

39. Data Security

This chapter explains how to setup Data Security.

39.1. Overview.....	39-2
39.2. Configuration	39-2

39.1. Overview

Data Security allows setting restrictions on the write operations that modify local Word or Bit register data. To do so, open [System Parameter Settings] » [Device] tab, select [Local HMI] and then click [Security...] button.

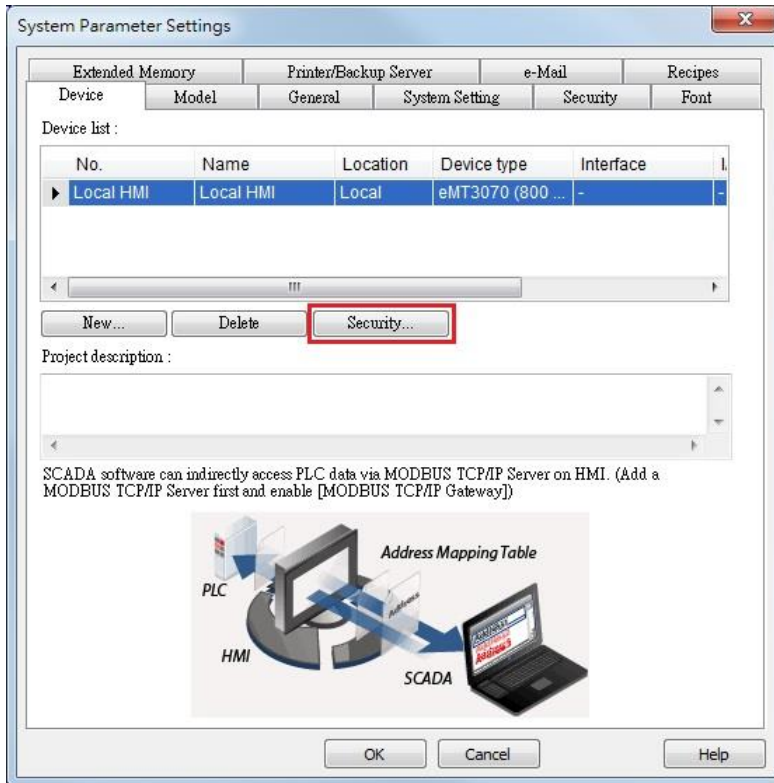

39.2. Configuration

The following is the settings dialog box:

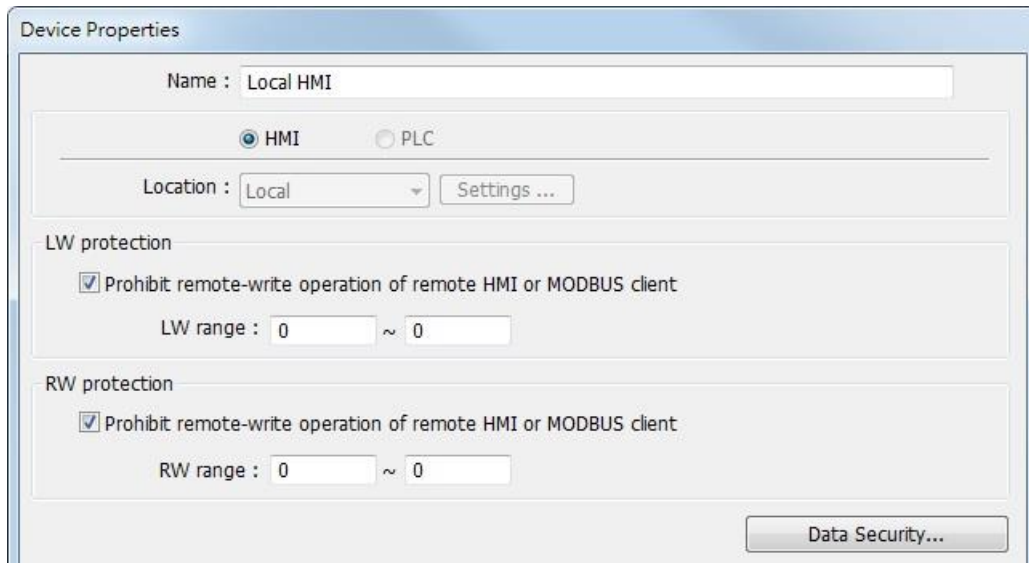

Setting	Description
LW protection \ Prohibit remote-write operation of remote HMI or MODBUS client	If selected, a remote HMI or MODBUS client will not be able to write to the specified LW addresses.
RW protection \ Prohibit remote-write operation of remote HMI or MODBUS client	If selected, a remote HMI or MODBUS client will not be able to write to the specified RW addresses.

Click [Data Security] button to set the restrictions on the write operations that modify local Word or Bit register data.

39.2.1. Word address settings

Set the restrictions relevant to local Word addresses.

Setting	Description
Description	Enter the description or memo about this setting.
Address Mode	Select [Word] to set the relevant attributes.
Min. value	Set the minimum value that can be written to the designated word address.
Max. value	Set the maximum value that can be written to the designated word address.
Disable remote-write operation	If selected, the remote HMI will not be able to write to the protected address.
Used only in remote-write operation	If selected, the range between [Min. value] and [Max. value] is only used to restrict the value written by a remote device.
Use min. value when write value is less than min. value	If selected, when the written value is less than [Min. value], the system will write the specified minimum value instead. If not selected, when the written value is less than [Min. value], the system will keep the original value.
Use max. value when write value is more than max. value	If selected, when the written value is greater than [Max. value], the system will write the specified maximum value instead.

If not selected, when the written value is greater than [Max. value], the system will keep the original value.

Notification

When the written value is not within the specified range between [Min. value] and [Max. value], the system will trigger the designated notification bit address.

As shown in the preceding figure, the remote HMI will not be able to write to LW-0, and when the value written to the local address is greater than 10, the value 10 is written instead, and the notification bit LB-0 will be set ON.

39.2.2. Bit address settings

Set the restrictions relevant to local Bit addresses.

Setting

Description

Description

Enter the description or memo about this setting.

Address Mode

Select [Bit] to set the relevant attributes.

Set ON only

If selected, the designated bit address can only be set ON.

Set OFF only

If selected, the designated bit address can only be set OFF.

Disable remote-write operation	If selected, the remote HMI will not be able to write to the protected address.
Used only in remote-write operation	If selected, the specified condition is only used to restrict the write operation by a remote device.
Notification	When enabled and: <ul style="list-style-type: none">● Select [Set ON], the system will trigger the notification bit address when attempting to set OFF the protected bit address.● Select [Set OFF], the system will trigger the notification bit address when attempting to set ON the protected bit address.

As shown in the preceding figure, the remote HMI can only set ON LB-10, while the local HMI is not restricted. If the remote HMI attempts to set LB-10 OFF, the system will trigger notification bit LB-0 ON.

40. Web Streaming

This chapter explains how to setup Web Streaming.

40.1. Overview.....	40-2
40.2. Configuration	40-2
40.3. Operation.....	40-2
40.4. Applicable Models	40-3

40.1. Overview

With Web Streaming function, video from the USB camera on HMI can be streamed and viewed in web browsers, and third party devices.

40.2. Configuration

Instead of setting an object in EasyBuilder Pro, Web Streaming is controlled by system registers. To enable Web Streaming, please set bit addresses or use macros to add the following system registers into the project file.

LB-12356: open(set on)/close(set off) web streaming server

LB-12357: web streaming server status. (on: opened / off: closed)

Set LB-12356 on to start Web Streaming, and set LB-12356 off to stop Web Streaming. LB-12357 indicates the streaming status. When LB-12357 is on, Web Streaming is enabled and running. When LB-12357 is off, Web Streaming is stopped. Web Streaming cannot start when the USB camera is not connected.

40.3. Operation

First, please make sure that the Web Streaming browser is enabled and running. To stream video on a browser, enter HMI's IP address with port 8080. For example, if the IP address is 192.168.1.100, please enter:

<http://192.168.1.100:8080>

Example 1

The following is a still image of video stream on iPad's Safari of a plant monitoring application.

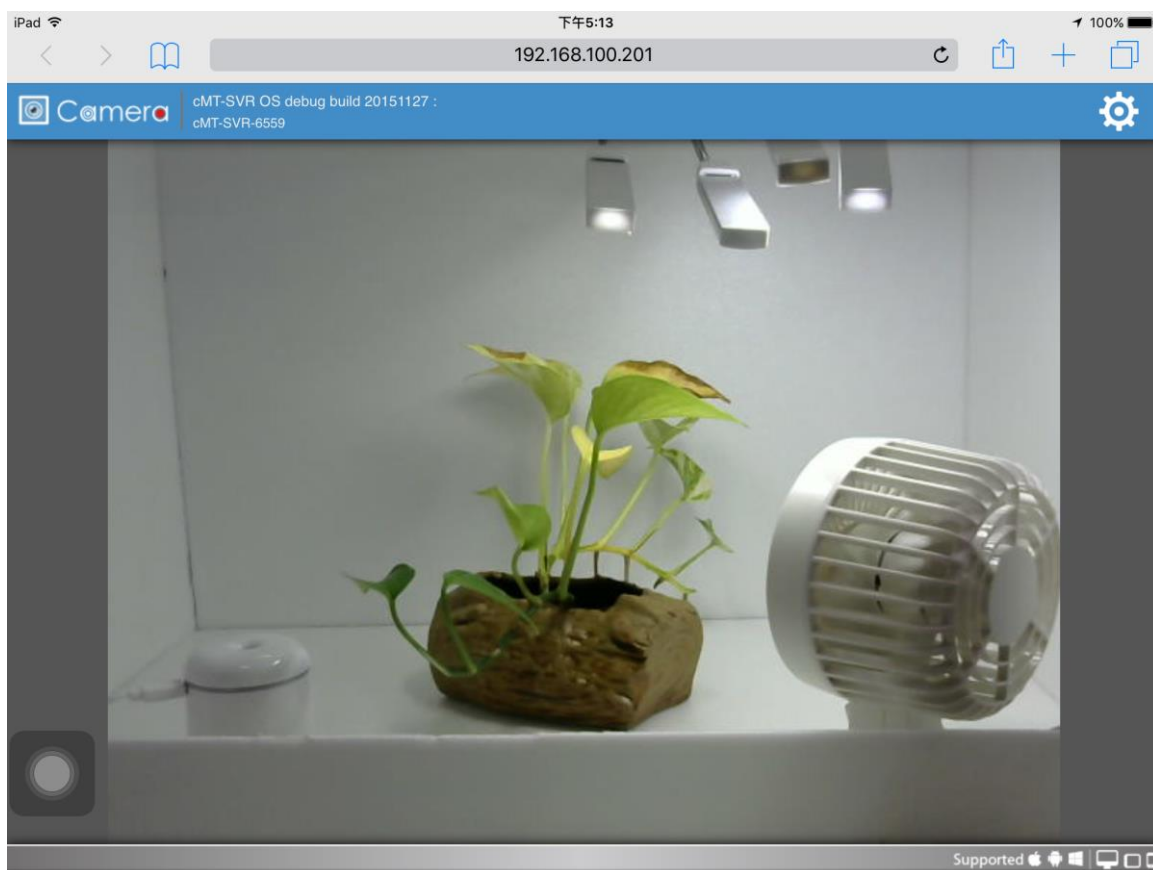

Note

- When using EasyAccess 2.0, the HMI's IP address is the virtual IP address obtained in the software.

40.4. Applicable Models

Model	OS Version	EasyBuilder Pro Version
eMT Series	20150525	V5.04.01.013
XE Series / eMT3070B	20150225	V5.04.01.013
mTV	20150508	V5.05.01
cMT-SVR	20151117	V5.03.02

41. Energy

This chapter explains how to setup Energy Demand Settings to monitor and record energy consumption and calculate future energy demands.

41.1. Energy Demand Setting	41-2
41.2. Energy Demand Display	41-6

41.1. Energy Demand Setting

41.1.1. Overview

By monitoring the recorded energy consumption in a specified period, the Energy Demand Setting feature can calculate future energy demands, and help saving energy.

41.1.2. Configuration

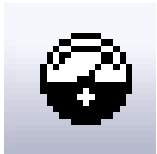

Click on the Energy Demand Setting icon on the toolbar or select [Energy] » [Demand] » [Setting] to open the settings dialog box. Configure General and Demand Threshold settings and click OK; an Energy Demand Setting object will be created.

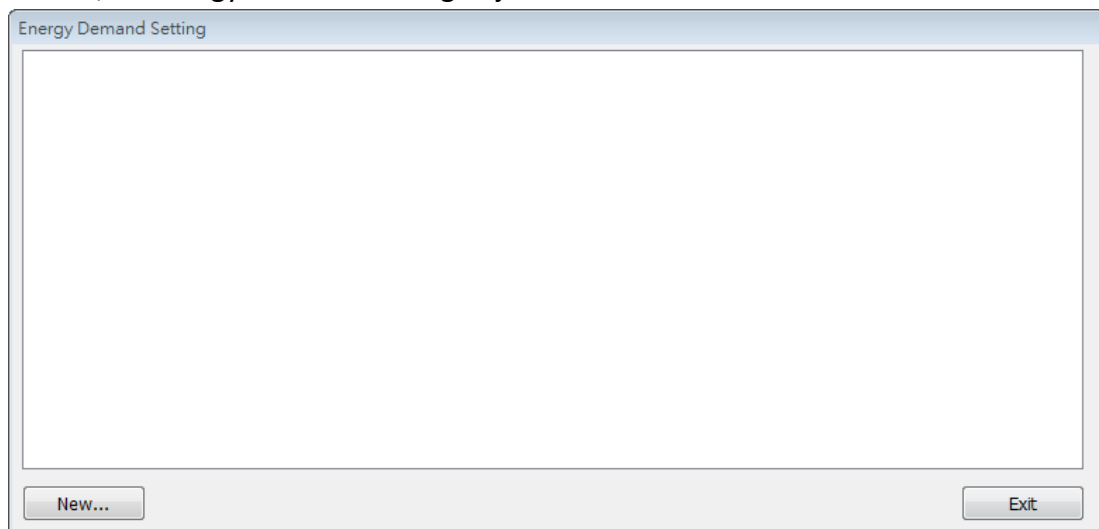

General Tab

Energy Demand Setting

General Demand Threshold Demand output

Comment :

Accumulative energy address

PLC : Local HMI

Address : LW 0 16-bit Unsigned

Units : 0.01 kWh

Demand update frequency : 1 minute(s) (1~60)

Demand duration : 15 minute(s) (1~60)

Setting	Description
Accumulative energy address	This address records energy consumption. The unit can be 0.1/0.01/0.001 kWh (kilowatt-hours).
Demand update frequency	The frequency to record energy consumption, the range is from 1 to 60 minutes.
Demand duration	The frequency to calculate energy demand. The range is from 1 to 60 minutes.

Note

- Please note that Demand Duration (T) must be an integral multiple of Demand Update Frequency (t).

Demand Threshold

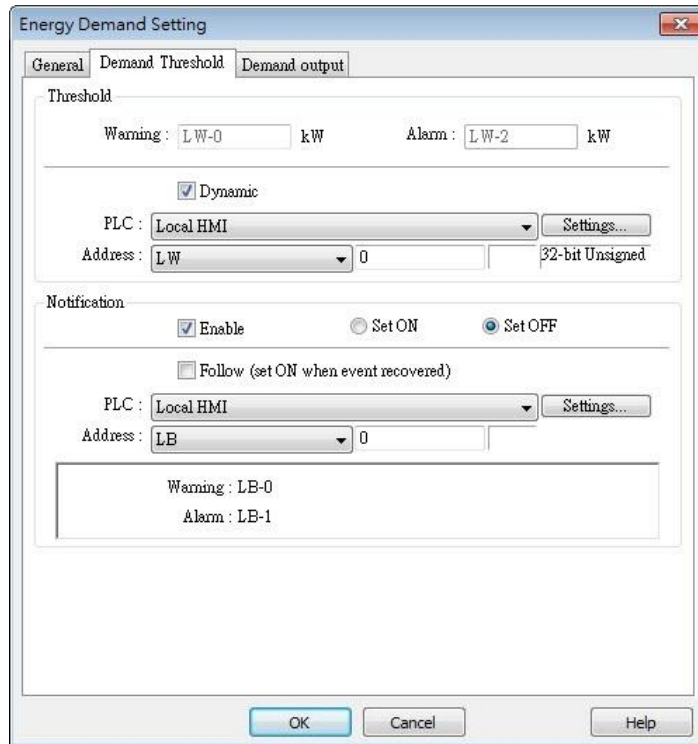

Setting	Description
Threshold	When the values in the specified addresses reach the values specified in Warning and Alarm fields, the warning and alarm will be triggered. The threshold limits can be dynamically changed at runtime.
Notification	When the estimated energy demand reaches the threshold limit, the status of the specified bit address will change accordingly.
Follow	If selected, when the estimated energy demand falls less than the threshold limit, the status of the notification bit address will return to its original state.

Demand Output

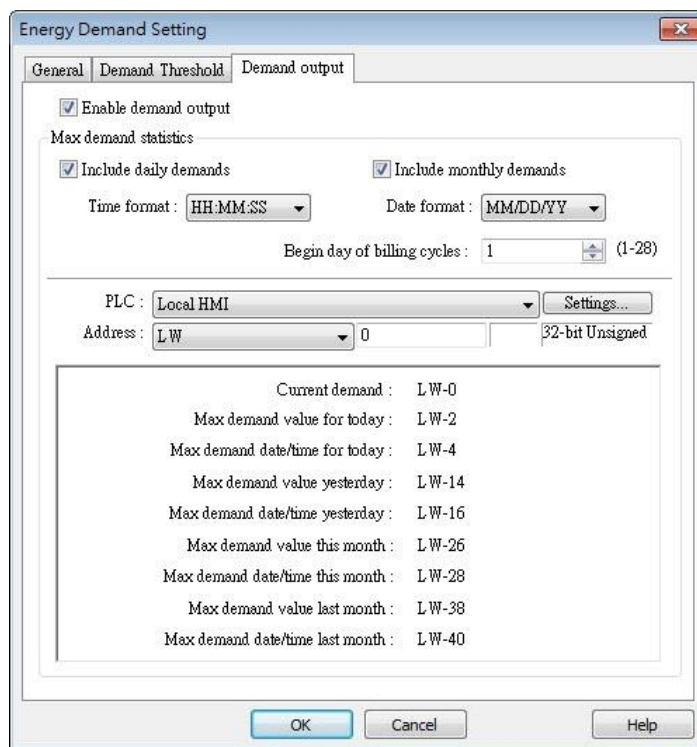

Setting	Description
Enable demand output	Opens [Max. demand statistics] settings.
Max demand statistics	The maximum energy demand of today/yesterday, and current month/last month, can be recorded in the corresponding addresses. The time/date format, and the beginning day of the billing cycle, can be specified.

41.2. Energy Demand Display

41.2.1. Overview

Energy Demand Display object graphs the result from Energy Demand Setting object at runtime.

The font, grid and watch line style can be specified, and the threshold limits can be shown in the graph.

41.2.2. Configuration

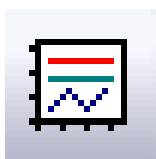

Click on the Energy Demand Display icon on the toolbar or select [Energy] » [Demand] » [Display] to open the settings dialog box. Configure the attributes and click OK; an Energy Demand Display object will be created.

General Tab

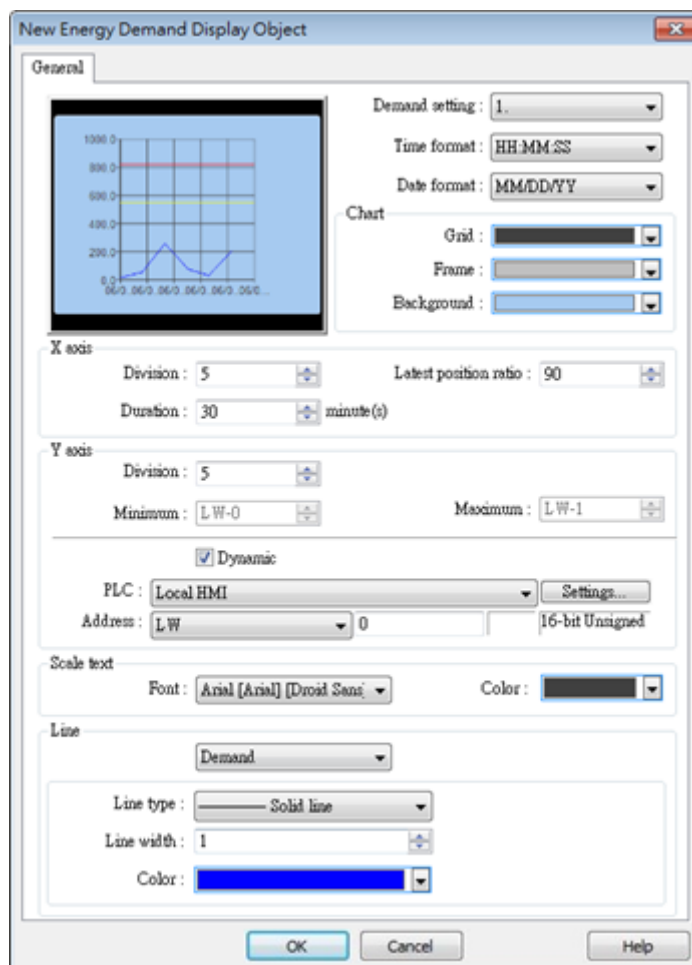

Setting	Description
Object index	Select an existing Energy Demand Setting object as the data source of Energy Demand Display object.
Time/Date format	Set Time and Date format.
Chart	Set the colors of Grid, Frame, and Background.
X axis	Set the number of divisions and time duration on the X axis. Latest position ratio: The ratio represents a position along the X axis, where 50% represents the middle and 100% represents the right end. This field sets the position to mark the latest data, and the acceptable range is: 50%~100%.
Y axis	Set the number of divisions, maximum and minimum scale values on the Y axis. The limits can be changed dynamically at runtime.
Scale text	Set the font and color of the scale text.

Line	Three watch lines marking Demand, Alarm, and Warning can be shown. The type, width, and color of the lines can be customized.
-------------	---

Example 1

The following example illustrates the relationship between Demand Duration (T) and Demand Update Frequency (t) mentioned in Energy Demand Setting guide above.

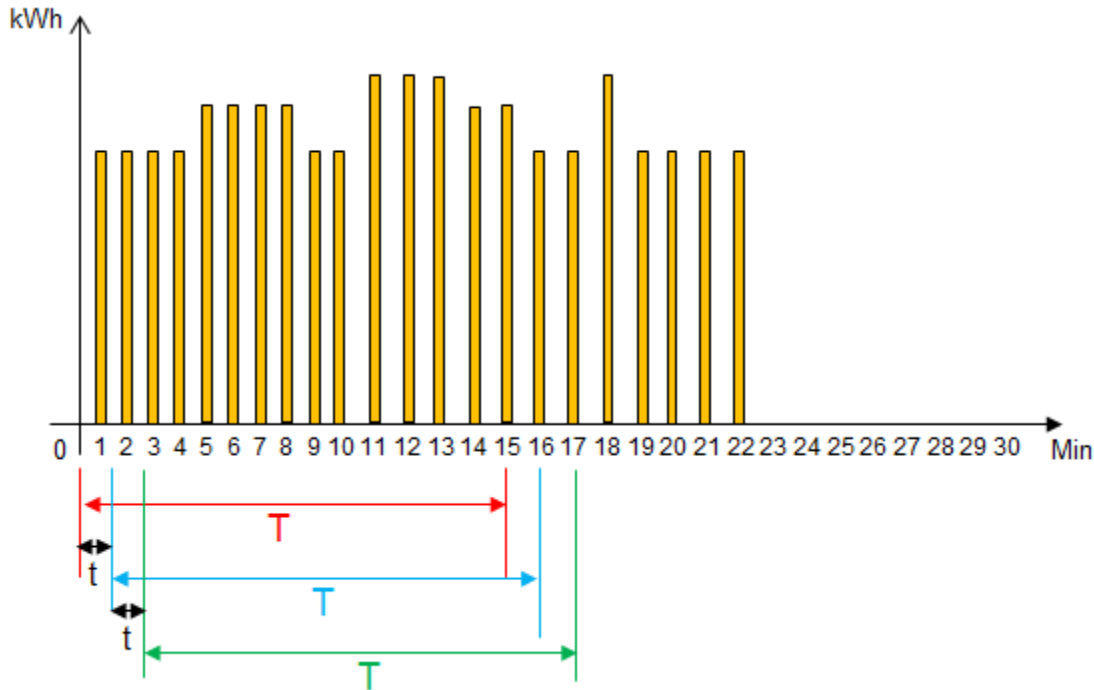

1. As shown in the above figure, when $t=1$, the frequency to record energy consumption will be once per minute. When $T=15$, each 15 minutes the sum of the energy consumption measured every minute ($t=1$) will be calculated.
2. From the 1st to the 15th minute (red zone), the energy consumption measured each minute will be added up to get the total sum. The total sum times 4 (15 minutes is a quarter of an hour) to obtain a value (kWh) indicating the estimated energy demand.
3. From the 2nd to the 16th minute (blue zone), the energy consumption measured each minute will be added up to get the total sum. The total sum times 4 (15 minutes is a quarter of an hour) to obtain a value (kWh) indicating the estimated energy demand.
4. From the 3rd to the 17th minute (green zone), the energy consumption measured each minute will be added up to get the total sum. The total sum times 4 (15 minutes is a quarter of an hour) to obtain a value (kWh) indicating the estimated energy demand.
5. The Energy Demand Display object will graph the estimated energy demand.
6. If $t=3$ and $T=15$, the estimated energy demand will be: Sum of the latest 5 records ($15/3=5$)

times 4 (15 minutes is a quarter of an hour).

7. If $t=5$ and $T=30$, the estimated energy demand will be: Sum of the latest 6 records ($30/5=6$) times 2 (30 minutes is half an hour).



Click the icon to download the demo project. Please confirm your internet connection before downloading the demo project.

42. IIoT

This chapter explains how to use IIoT protocols.

42.1. MQTT	42-2
42.2. OPC UA Server	42-13

42.1. MQTT

42.1.1. Overview

MQTT object can send message to a remote server, or subscribe to topics on a remote server.
HMI can serve as a local server.

When HMI serves as a local server, the HMI will not send message to the remote server.

This feature supports MQTT ver. 3.1.

42.1.2. Configuration



Click the MQTT icon on the toolbar to create a MQTT object. Or, click [IIoT] » [MQTT] in the menu.



42.1.2.1. Server Settings

General Tab



Setting	Description
IP	Enter the MQTT Server IP address for receiving the message. If [Localhost] is checked, HMI will run a MQTT server locally.
Use domain name	<div style="border: 1px solid gray; padding: 2px; display: inline-block;">IP : 127.0.0.1</div> <input checked="" type="checkbox"/> Use domain name A domain name can be used as MQTT server's IP address.

Password	Enter the password for connecting MQTT Server.
Keep alive time	<p>When MQTT Server does not receive the message from HMI passing the specified time, the HMI will be identified as disconnected.</p> <p>Note: When running simulation, the message may be delayed, but the delay will not exceed the [Keep alive time]. The message from the HMI will be sent immediately.</p>
Auto-connection	<p>In this mode, the connection will be automatically terminated if there's no data update for a specified period of time. The connection will resume once any data update occurs.</p> <p>The user can choose to publish initial values / topic list only at the first connection.</p> <p>In this mode, the start and stop commands are disabled.</p>

Address Tab

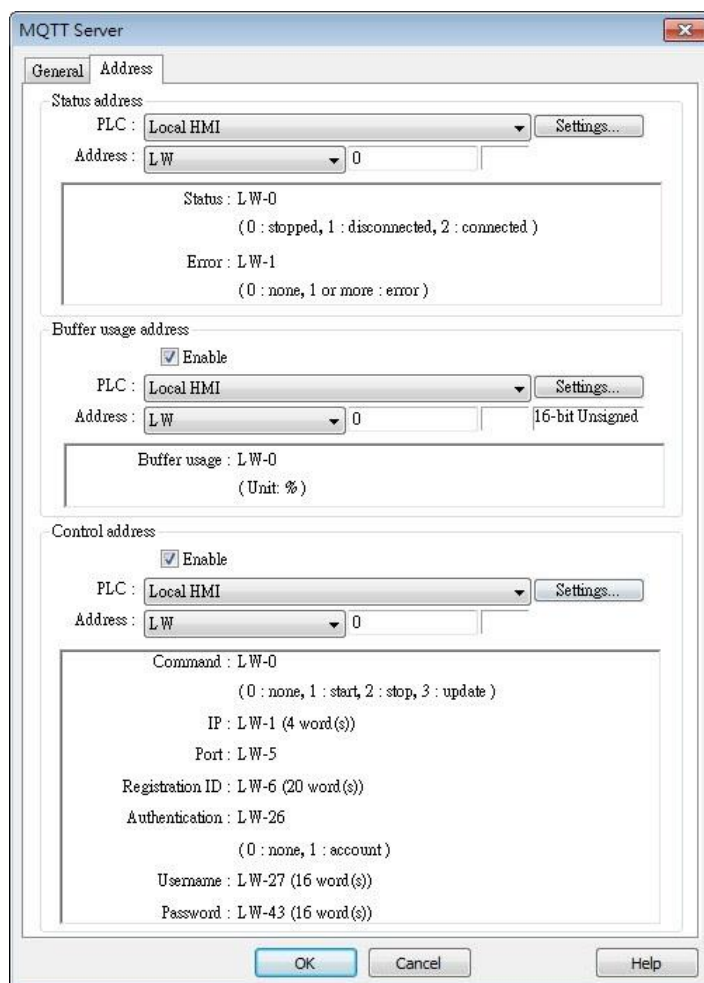

Setting	Description								
Status address	LW-n: Displays the connection status to MQTT Server.								
	<table border="1"> <thead> <tr> <th>Value</th> <th>Description</th> </tr> </thead> <tbody> <tr> <td>0</td> <td>Not attempting to connect to MQTT Server.</td> </tr> <tr> <td>1</td> <td>Disconnected and can't connect to MQTT Server.</td> </tr> <tr> <td>2</td> <td>Connection succeeded.</td> </tr> </tbody> </table>	Value	Description	0	Not attempting to connect to MQTT Server.	1	Disconnected and can't connect to MQTT Server.	2	Connection succeeded.
Value	Description								
0	Not attempting to connect to MQTT Server.								
1	Disconnected and can't connect to MQTT Server.								
2	Connection succeeded.								
	LW-n+1: Error indicator.								
	<table border="1"> <thead> <tr> <th>Value</th> <th>Description</th> </tr> </thead> <tbody> <tr> <td>0</td> <td>No error</td> </tr> <tr> <td>1 or more</td> <td>An error occurred</td> </tr> </tbody> </table>	Value	Description	0	No error	1 or more	An error occurred		
Value	Description								
0	No error								
1 or more	An error occurred								
Buffer usage address	Messages that have not been sent are stored in the buffer. The maximum buffer capacity is 10000								

messages. The buffer capacity is measured in percentage (%), rounded up.

LW-n: Shows buffer usage.

Control address

LW-n: Controls the operation of MQTT Server.

Value	Description
0	Ready
1	Start
2	Stop
3	Update

LW-n+1: Sets the IP address of MQTT Server.

LW-n+5: Sets the port number of MQTT Server.

LW-n+6: Sets the Registration ID for connecting MQTT Server.

LW-n+26: Enables / Disables authentication.

Value	Description
0	Disable
1	Enable

LW-n+27: Sets the username for connecting MQTT Server.

LW-n+43: Sets the password for connecting MQTT Server.

TLS/SSL Tab

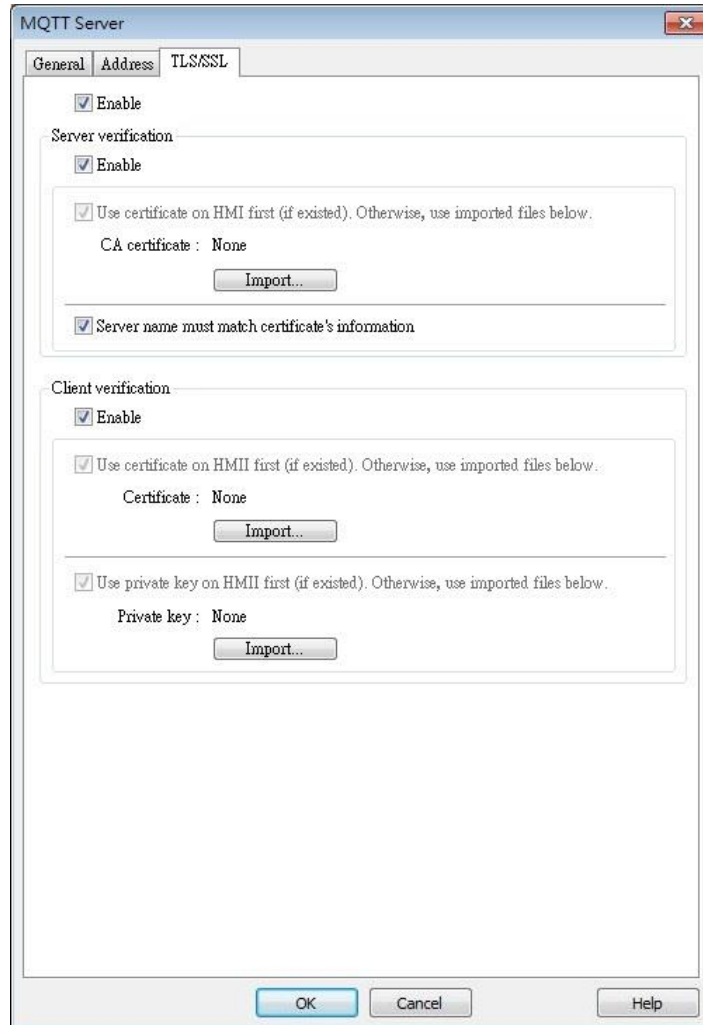

Setting	Description
Enable	Enable TLS/SSL authentication.
Server verification	<p>Enable</p> <p>Verify whether the server certificate is signed by CA (certificate authority) certificate. Server certificate is sent from server during connection.</p> <p>Server name must match certificate's information</p> <p>Verify whether the server's IP matches the IP records in the server certificate which is sent. The IP records are stored in Subject Alternative Name of the certificate.</p>
Client verification	By providing a private key and certificate, the server can verify the client faster, skipping login by username or password.

42.1.2.2. MQTT Topic Publisher

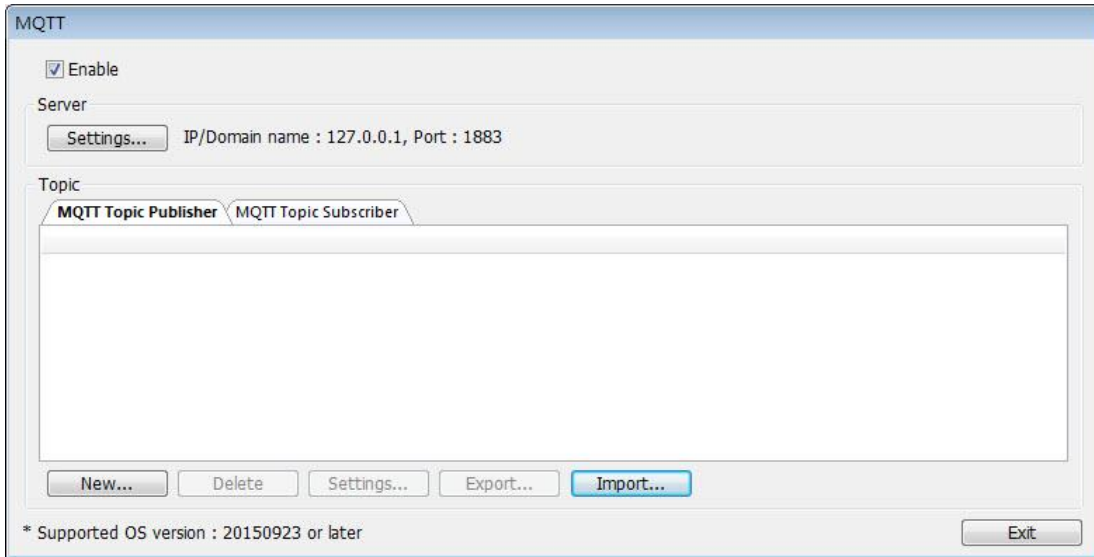

Click [New] to open General and Address settings, or click [Import] / [Export] to import or export an existing *.csv file. The maximum allowable number of topics is 255.

General Tab

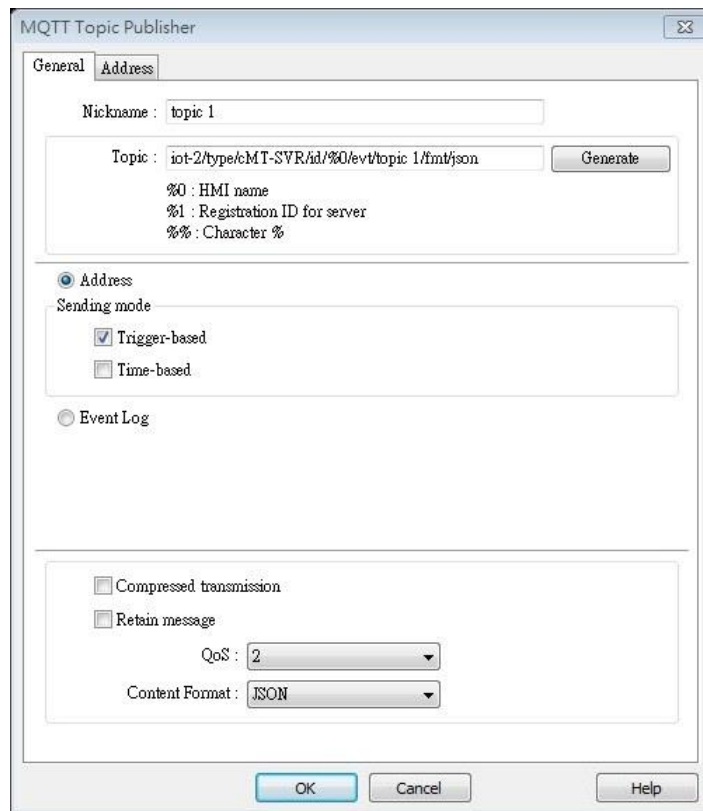

Setting	Description
Nickname	Enter the nickname of the MQTT Topic for easier reference.

Topic	Specify the format of the message topic sent to MQTT Server.
Address	<p>Sending mode</p> <p>Select the sending mode from Trigger-based or Time-based, or both.</p>
Event Log	<div style="border: 1px solid #ccc; padding: 5px;"> <input checked="" type="radio"/> Event Log <input type="checkbox"/> Include recover event Event log type <input checked="" type="checkbox"/> From event ID No. 1, Event 0 ▾ <input type="checkbox"/> From event category </div> <p>The topic source can be an Event Log.</p>
Compressed transmission	The message will be compressed before being sent, and decompression is needed before reading the message. Messages in MQTT are compressed / decompressed with DEFLATE algorithm.
Retain message	If selected, the MQTT server will save the latest message.
QoS	<p>MQTT provides three levels of reliability, which are known as qualities of service (QoS). The reliability of the message determines the persistence of the message.</p> <p>0: At most once, messages are not persistent.</p> <p>1: At least once.</p> <p>2: Exactly once.</p>
Content Format	The supported formats are: JSON and Raw Data.

Address Tab

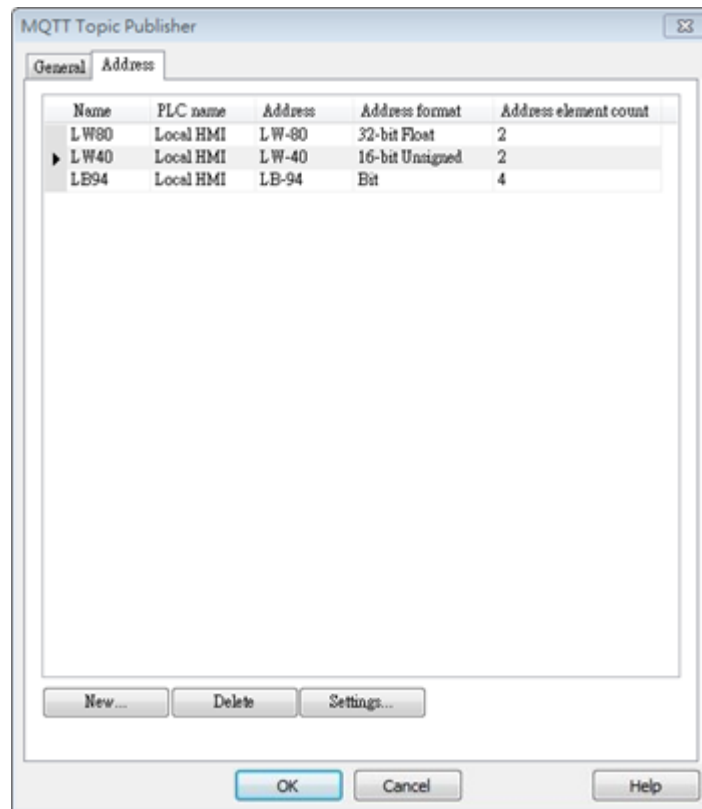

Setting	Description
New	Add the source of the topic. The length of each address can be specified respectively.
Delete	Delete the address.
Setting	Change the name and address.

42.1.2.3. MQTT Topic Subscriber

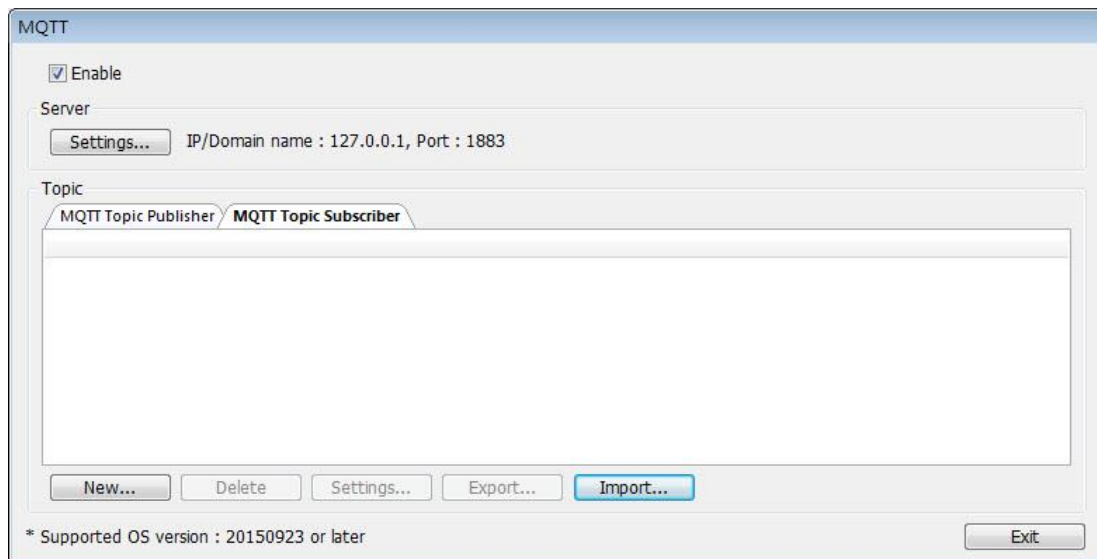

Click [New] to open General and Address settings, or click [Import] / [Export] to import or export an existing *.csv file. The maximum allowable number of topics is 255.

General Tab

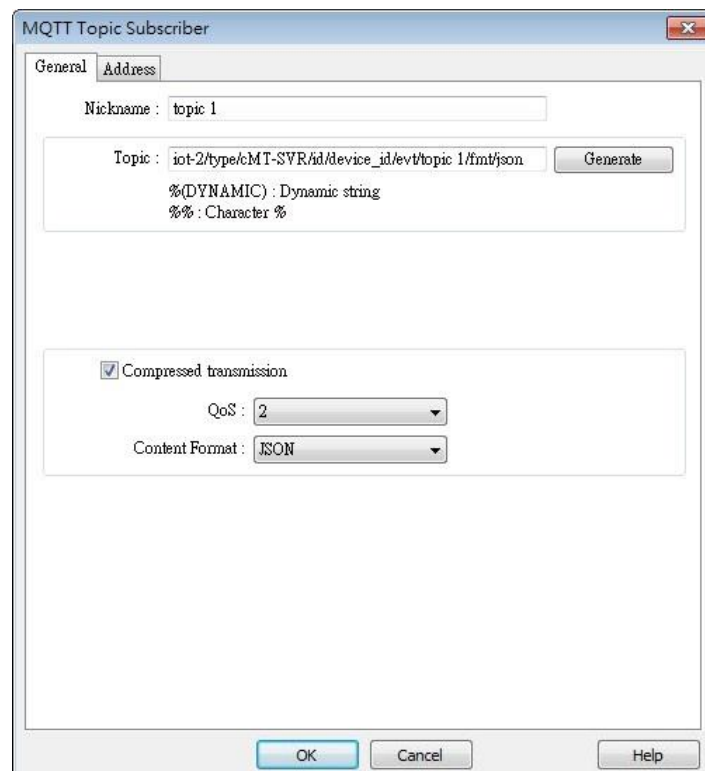

Setting	Description
Nickname	Enter the nickname of the MQTT Topic for easier reference.

Topic	Subscribe to a topic in MQTT Server. The topic name can be dynamic.
Compressed transmission	Configure with the same setting as MQTT Topic Publisher.
QoS	MQTT provides three levels of reliability, which are known as qualities of service (QoS). The reliability of the message determines the persistence of the message. 0: At most once, messages are not persistent. 1: At least once. 2: Exactly once.
Content Format	The supported formats are: JSON and Raw Data.

Address Tab

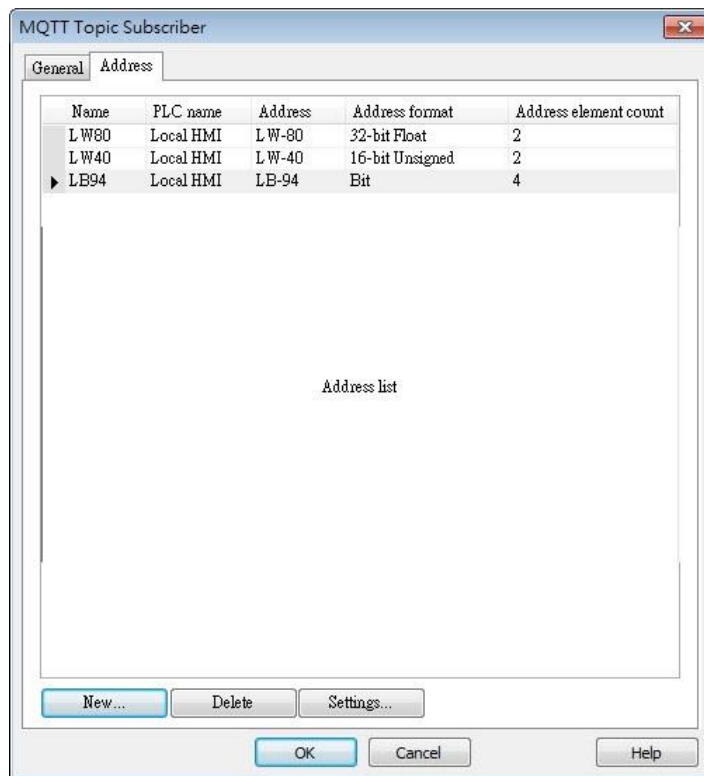

Setting	Description
New	Add the destination address of the subscribed topic. The length of each address can be specified respectively.
Delete	Delete the address.
Setting	Change the name and address.

42.2. OPC UA Server

42.2.1. Overview

OPC UA (Unified Architecture) is a communication technology often used in industrial automation fields. OPC UA features cross-platform interoperability, unified access, standardized communication, and security. In this architecture, cMT Series HMI models with built-in OPC UA server play a key role as Communication Gateway, and allow OPC UA clients to access HMI or PLC data by subscribing to tags to receive real-time updates. This new architecture can help you achieve vertical integration.

Hardware & Software requirements:

- HMI Model: cMT-G01, cMT3090, cMT3151
- Software: EasyBuilder Pro V5.06.01 or later
- Recommended OPC UA Client: Unified Automation UaExpert

42.2.2. Configuration

Click on the OPC UA Server icon on the toolbar or select [IIoT] » [OPC UA Server] and then select [Enable] check box to open the settings dialog box.

General Tab

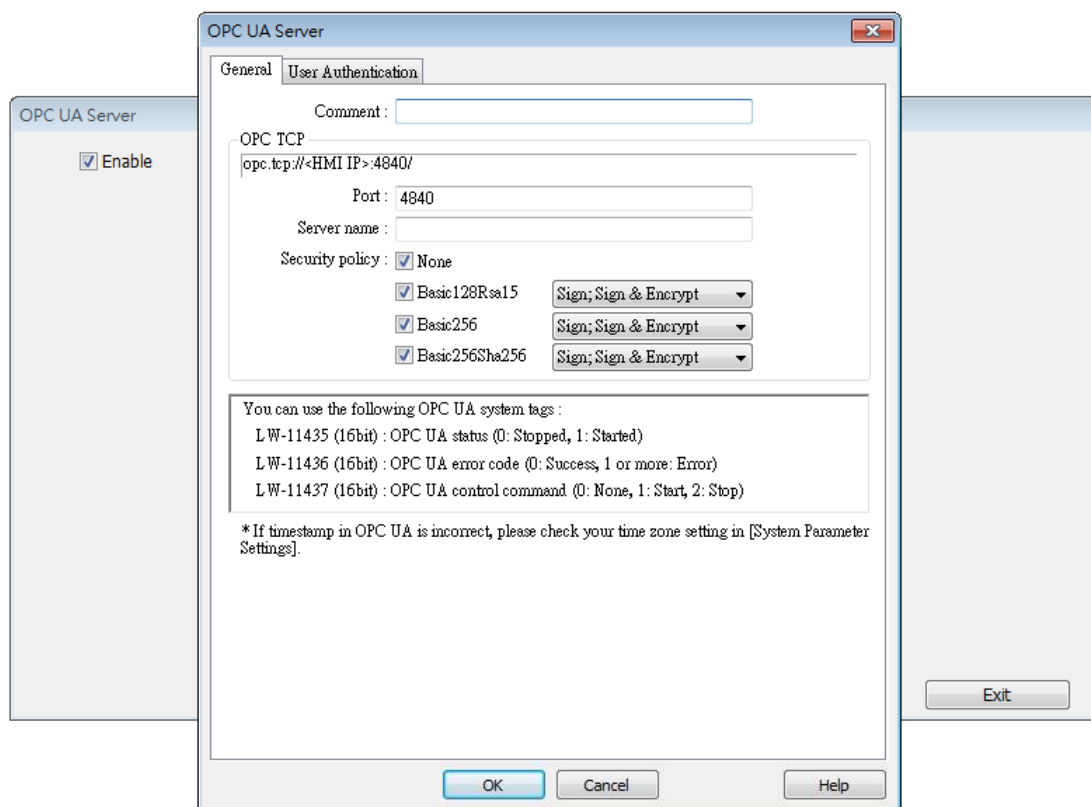

Setting	Description
Comment	The description about the OPC UA Server.
OPC TCP	The URL of the server.
Port	The port number for the clients to connect with OPC UA Server. The default port number is 4840.
Server name	The server name, this field is allowed to remain blank.
Security Policy	Configure the security policy that can be used by clients.

User Authentications Tab

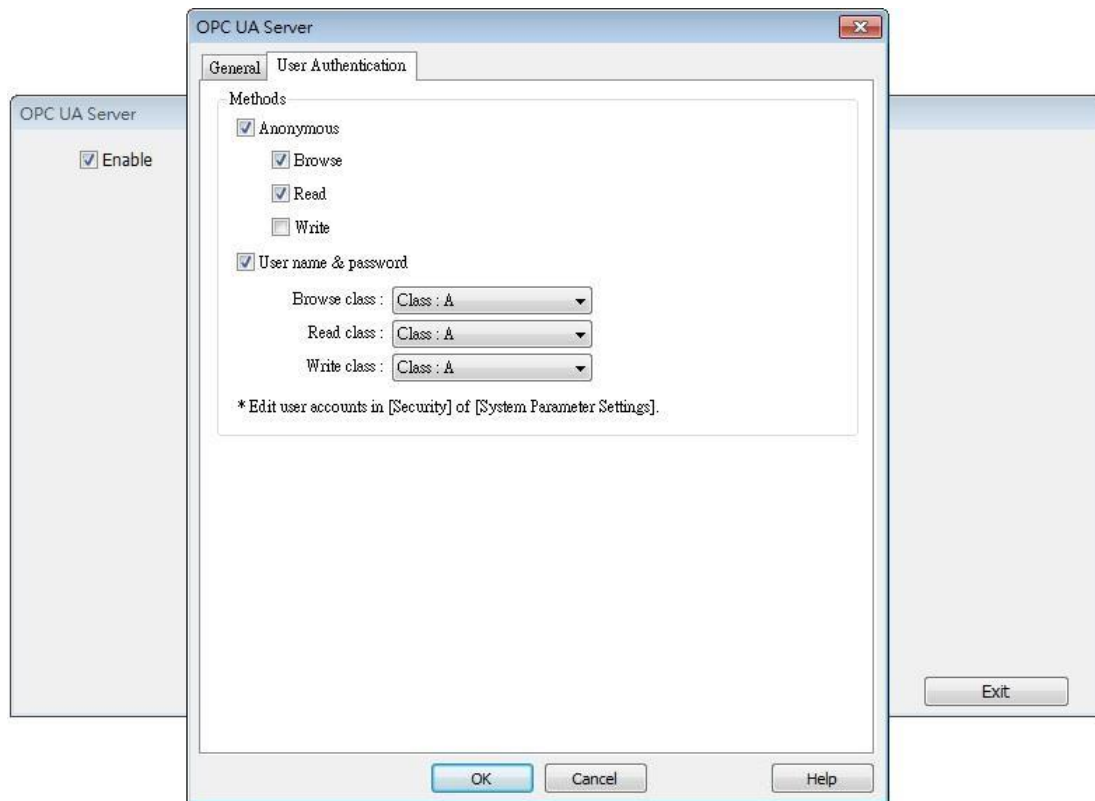

Setting

Methods

Description

Anonymous

Grant Browse, Read, Write permissions to anonymous login by selecting the checkboxes.

User name & password

Use the same user name and password as HMI. The permissions are granted to the security classes specified in System Parameter Settings » Security.

Tag

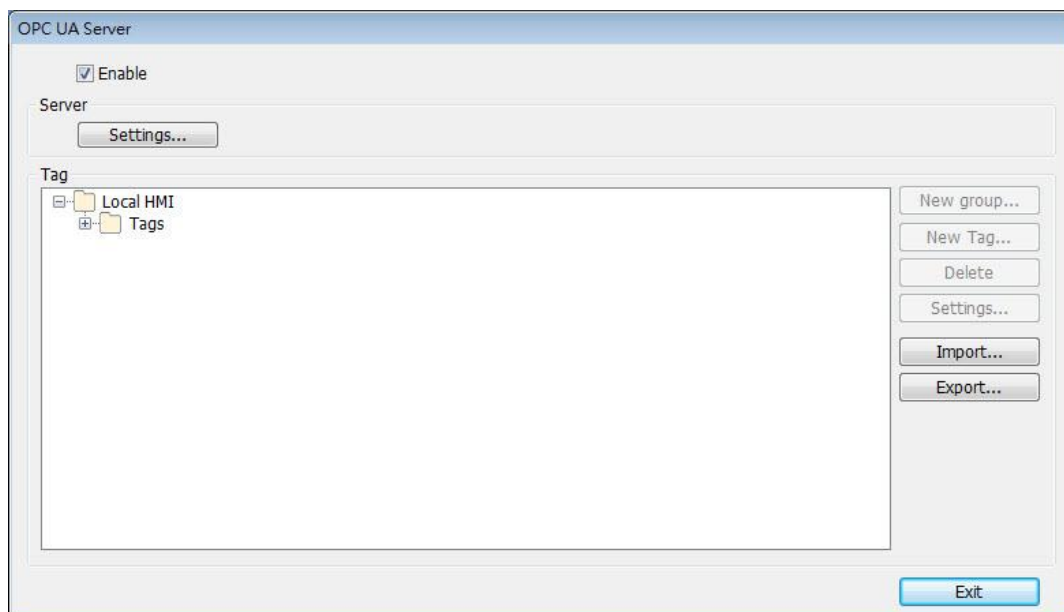

Setting

Description

New group

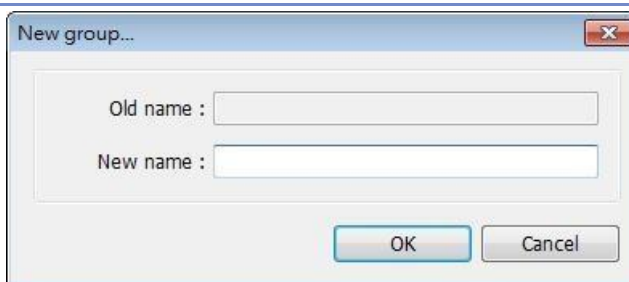

Add a new group for managing tags.

New Tag

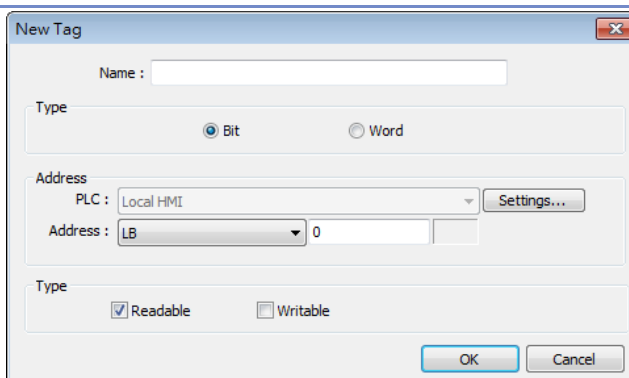

Add a new tag for the client to monitor or control. The name must be entered, and the address can be Readable or Writeable.

Delete

Delete an existing group or tag.

Settings

Set an existing group or tag.

Import

Import a tag file.

Export

Export current tags.

 **Note**

- When downloading the project file to HMI, please make sure that the HMI time and time-zone settings are correct. Otherwise, the client program may not be able to authenticate, and the communication may fail due to authentication error caused by incorrect certificate valid time.

Appendix A.

Comparison of HMI Software Features

- eMT Series: eMT3070B, eMT3105P, eMT3120A, eMT3150A
- cMT Series: cMT-SVR-100, cMT-SVR-102, cMT-iv5, cMT3151, cMT3090, cMT-G01
- mTV Series: mTV-100
- iE Series: MT8050iE, MT6070iE, MT6071iE, MT8070iE, MT8071iE, MT8073iE, MT8100iE, MT8101iE, MT8102iE, MT8103iE
- iER Series: MT8070iER1
- XE Series: MT8090XE, MT8091XE, MT8092XE, MT8121XE, MT8150XE
- iP Series: MT6051iP, MT8051iP, MT6071iP, MT8071iP, MT6103iP, MT8102iP

Series	iP	iE	eMT	mTV	XE	cMT-SVR	cMT3151/ 3090	cMT-G01
Project & Firmware size limit	22.5MB	22.5MB	64MB	64MB	64MB	32MB	64MB	32MB
History size limit	16MB	16MB	64MB	64MB	64/120MB	(*1)	(*1)	Event Log
Build Data for USB Disk or SD Card Download	Y	Y	Y	Y	Y	N/A	N/A	N/A
Project Protection	N/A	Y	Y	Y	Y	Y	Y	Y
USB Disk Download	Y	Y	Y	Y	Y	N/A	Y	N/A
USB Direct Download	Y	Y	Y	N/A	Y	N/A	Y	N/A
Picture/Shape Library embedded in Project	Y	Y	Y	Y	Y	Y	Y	N/A
PLC TAG embedded in project	Y	Y	Y	Y	Y	Y	Y	Y
3G/4G Dongle	N/A	N/A	N/A	N/A	N/A	Y	N/A	N/A
e-Mail	N/A	Y	Y	Y	Y	Y	Y	Y
Enhanced security mode	N/A	Y	Y	Y	Y	Y	Y	Y
Ethernet Printer	N/A	N/A	N/A	N/A	N/A	N/A	Y	N/A
Off-line Simulation on HMI	Y	Y	Y	Y	Y	Y	Y	N/A
User-defined Startup Screen	Y	Y	Y	Y	Y	N/A	Y	N/A
USB Tethering	N/A	Y	Y	Y	Y	Y	Y	N/A
VNC Server	N/A	Y	Y	Y	Y	N/A	Y	N/A
Siemens PLC Pass-through	Y	Y	Y	Y	Y	Y	Y	Y
Audio Output	N/A	N/A	Y	Y (HDMI)	N/A	Y (Viewer)	Y	N/A
CAN Bus	N/A	N/A	Y	N/A	MT8091/2 XE	N/A	Y	N/A
Wi-Fi	N/A	MT8103iE	N/A	N/A	N/A	N/A	N/A	N/A
Barcode Scanner (Android Camera)	N/A	N/A	N/A	N/A	N/A	Y	Y	N/A
Circular Trend Display	N/A	Y	Y	Y	Y	N/A	N/A	N/A
Contacts Editor	N/A	Y	Y	Y	Y	Y	Y	N/A
Combo Button	N/A	Y	Y	Y	Y	Y	Y	N/A
Database Server	N/A	N/A	N/A	N/A	N/A	Y	Y	Y
Date/Time	Y	Y	Y	Y	Y	Y	Y	N/A
Dynamic Drawing	N/A	Y	Y	Y	Y	N/A	N/A	N/A

Series	iP	iE	eMT	mTV	XE	cMT-SVR	cMT3151/ 3090	cMT-G01
Dynamic Scale	N/A	Y	Y	Y	Y	Y	Y	N/A
Energy Demand Setting	N/A	N/A	N/A	N/A	N/A	Y	Y	N/A
Energy Demand Display	N/A	N/A	N/A	N/A	N/A	Y	Y	N/A
File Browser	N/A	Y	Y	Y	Y	N/A	Y	N/A
Flow Block	N/A	Y	Y	Y	Y	Y	Y	N/A
IP Camera	N/A	N/A	Y	N/A	Y	N/A	N/A	N/A
Media Player	N/A	N/A	eMT3105/ 3120/3150	N/A	Y	N/A	Y	N/A
MQTT(Publisher)	N/A	Y	Y	Y	Y	Y	Y	Y
MQTT(Subscriber)	N/A	N/A	N/A	N/A	N/A	Y	Y	Y
Operation Log Printing	N/A	Y	Y	N/A	Y	Y	Y	N/A
Operation Log Settings	N/A	Y	Y	N/A	Y	Y	Y	N/A
Operation Log View	N/A	Y	Y	N/A	Y	Y	Y	N/A
OPC UA Server	N/A	N/A	N/A	N/A	N/A	N/A	Y	Y
OPC UA Client	Y	Y	Y	Y	Y	Y	Y	Y
PDF Reader	N/A	N/A	N/A	N/A	N/A	N/A	Y	N/A
Picture Viewer	N/A	Y	Y	Y	Y	N/A	Y	N/A
Pie Chart	N/A	Y	Y	Y	Y	N/A	Y	N/A
Recipe Database	N/A	Y	Y	Y	Y	Y	Y	N/A
Recipe Import/Export	N/A	Y	Y	Y	Y	Y	Y	N/A
Recipe View	N/A	Y	Y	Y	Y	Y	Y	N/A
String Table	N/A	Y	Y	Y	Y	N/A	N/A	N/A
Table	N/A	Y	Y	Y	Y	Y	Y	N/A
Time Synchronization	N/A	Y	Y	Y	Y	Y	Y	Y
USB Camera	N/A	N/A	Y	Y	Y	N/A	cMT3151	N/A
Video In	N/A	N/A	eMT3120 /3150	N/A	N/A	N/A	cMT3151	N/A
Web Streaming	N/A	N/A	Y	Y	Y	Y	N/A	N/A
VNC Viewer	N/A	Y	Y	Y	Y	N/A	N/A	N/A
EasyAccess 1.0	Y	Y	Y	Y	Y	N/A	N/A	N/A
EasyAccess 2.0	N/A	Y	Y	Y	Y	Y	Y	Y
EasyDiagnoser	Y	Y	Y	Y	Y	N/A	N/A	N/A
EasyLauncher	N/A	N/A	N/A	N/A	N/A	Y	Y	N/A
EasyPrinter	Y	Y	Y	Y	Y	N/A	N/A	N/A
EasySimulator	Y	Y	Y	Y	Y	N/A	N/A	N/A
EasySystemSetting	Y	Y	Y	Y	Y	N/A	N/A	N/A
EasyWatch	Y	Y	Y	Y	Y	Y	Y	Y
Utility Manager	Y	Y	Y	Y	Y	Y	Y	Y
Watchdog	Y	Y	Y	Y	Y	N/A	Y	N/A
Window Transparency	N/A	N/A	N/A	N/A	N/A	Y	Y	N/A
Windows Open/ Cycle/Close Macro	N/A	Y	Y	Y	Y	Y	Y	N/A
Combo Object	N/A	N/A	N/A	N/A	N/A	Y	Y	N/A

 **Note**

1. Maximum: 40 Data Samplings, 10,000 records for each.