



# APC-3X94P/R

15", 17", and 19" Intel® Celeron® N2930 Full IP66/IP69K Stainless Steel Panel PC

## User Manual

**Release Date**

**Revision**

Feb. 2016

V1.0

©2016 Aplex Technology, Inc.

All Rights Reserved.

Published in Taiwan

Aplex Technology, Inc.

15F-1, No.186, Jian Yi Road, Zhonghe District, New Taipei City 235, Taiwan

Tel: 886-2-82262881 Fax: 886-2-82262883 E-mail: [aplex@aplex.com.tw](mailto:aplex@aplex.com.tw) URL: [www.aplertec.com](http://www.aplertec.com)

# Revision History

Reversion	Date	Description
1.0	2016/02/15	Official Version

# Warning!

---

This equipment generates, uses and can radiate radio frequency energy and if not installed and used in accordance with the instructions manual, it may cause interference to radio communications. It has been tested and found to comply with the limits for a Class A computing device pursuant to FCC Rules, which are designed to provide reasonable protection against such interference when operated in a commercial environment. Operation of this equipment in a residential area is likely to cause interference in which case the user at his own expense will be required to take whatever measures may be required to correct the interference.

Electric Shock Hazard – Do not operate the machine with its back cover removed. There are dangerous high voltages inside.

## Caution

**Risk of explosion if the battery is replaced with an incorrect type.**

**Batteries should be recycled where possible. Disposal of used batteries must be in accordance with local environmental regulations.**

## Disclaimer

**This information in this document is subject to change without notice. In no event shall Apex Technology Inc. be liable for damages of any kind, whether incidental or consequential, arising from either the use or misuse of information in this document or in any related materials.**

## Packing List

Accessories (as ticked) included in this package are:
<input type="checkbox"/> Adaptor
<input type="checkbox"/> Driver & manual CD disc
<input type="checkbox"/> Other. _____ (please specify)

## Safety Precautions

Follow the messages below to prevent your systems from damage:

- ◆ Avoid your system from static electricity on all occasions.
- ◆ Prevent electric shock. Don't touch any components of this card when the card is power-on. Always disconnect power when the system is not in use.
- ◆ Disconnect power when you change any hardware devices. For instance, when you connect a jumper or install any cards, a surge of power may damage the electronic components or the whole system.

# Table of Contents

Revision History.....	1
Warning!/Caution/Disclaimer.....	2
Packing List.....	3
Safety Precautions.....	4

## Chapter 1 Getting Started

1.1 Features.....	7
1.2 Specifications.....	7
1.3 Dimensions.....	9
1.4 Brief Description of APC-3X94P/R.....	12
1.5 Installation of HDD/SSD.....	15
1.6 Mounting.....	16

## Chapter 2 Hardware

2.1 Motherboard Introduction.....	17
2.2 Specifications.....	17
2.3 Jumpers and Connectors Location.....	21
2.4 Jumpers Setting and Connectors.....	22

## Chapter 3 BIOS Setup

3.1 Operations after POST Screen.....	35
3.2 BIOS Setup Utility.....	35
3.3 Main Settings.....	36
3.4 Advanced Settings.....	37
3.5 Chipset Settings.....	45
3.6 Security Settings.....	47
3.7 Boot Settings.....	48
3.8 Save & Exit Settings.....	49

## Chapter 4 Installation of Drivers

4.1 Intel (R) Atom™ SoC Chipset .....	52
4.2 Intel (R) VGA Chipset.....	55
4.3 Intel (R) LAN Driver.....	59
4.4 Realtek ALC662 HD Audio Driver Installation.....	62
4.5 USB 3.0 Driver.....	63

4.6 Com Driver.....	66
---------------------	----

## **Chapter 5** Touch Screen Installation

5.1 Windows 7/8.1 Universal Driver Installation for PenMount 6000 Series.....	69
5.2 Software Functions.....	79

### **Figures**

Figure 1.1: Dimensions of APC-3594P/R – Standard & Optional I/O.....	9
Figure 1.2: Dimensions of APC-3794P/R – Standard & Optional I/O.....	10
Figure 1.3: Dimensions of APC-3994P/R – Standard & Optional I/O.....	11
Figure 1.4: Front View of APC-3594P/R.....	12
Figure 1.5: Rear View of APC-3594P/R.....	12
Figure 1.6: Front View of APC-3794P/R.....	13
Figure 1.7: Rear View of APC-3994P/R.....	13
Figure 1.8: Front View of APC-3994P/R.....	14
Figure 1.9: Rear View of APC-3994P/R.....	14
Figure 1.10: Panel Mounting of APC-3X94P/R.....	16
Figure 2.1: Motherboard Dimensions.....	20
Figure 2.2: Jumpers and Connectors Location-Board Top.....	21
Figure 2.3: Jumpers and Connectors Location-Board Bottom.....	21

# Chapter 1

# Getting Started

## 1.1 Features

- Low Power Consumption Panel PC
- Intel® Celeron® Processor N2930
- Onboard DDR3L 4GB 1333/1600MHz
- IP66/69K rated with M12 connector
- SUS304 Grade Stainless Steel Enclosure (SUS 316 Optional)
- Full Flat Bezel and Fanless Design
- Projective Capacitive Touch/Resistive Touch Window
- 9~36V DC Wide-ranging Power Input

## 1.2 Specifications

	APC-3594P/R	APC-3794P/R	APC-3994P/R
<b>System</b>			
CPU	Intel® Celeron® Processor N2930		
Chipset	SoC		
Memory	Onboard DDR3L 4GB 1333/1600 MHz		
<b>IO Port</b>			
USB	1 x M12 8-pin for 1 x USB 3.0		
Serial/Parallel	1 x M12 8-pin for RS-232/422/485, COM1, Default RS-232 1 x M12 8-pin for RS-232, COM2		
LAN	1 x M12 8-pin for GbE LAN		
Power	1 x M12 3-pin DC Power		
Optional I/O (either one)	1 x M12 8-pin for 2 x USB 2.0 (Default) 1 x Power Switch		
<b>Storage Space</b>			
Storage	1 x 2.5" SATA HDD or SSD, Easily accessible 1 x internal SD card slot onboard		
<b>Expansion</b>			
Expansion Slot	1 x Mini-PCIe full size For optional WLAN/BT Module and Antenna at rear side		
<b>Display</b>			
Display Type	15" color TFT LCD	17" color TFT LCD	19" color TFT LCD
Max. Resolution	1024 x 768	1280 x 1024	1280 x 1024



Max. Color	16.7M	16.7M	16.7M
Contrast Ratio	800: 1	1000: 1	1000: 1
Luminance (cd/m <sup>2</sup> )	420	350	350
Viewing Angle	160(H) / 160(V)	170(H) / 170(V)	170(H) / 160(V)
Backlight Lifetime	50,000 hrs	50,000 hrs	50,000 hrs
<b>Touch Screen – Resistive Touch Window Type (APC-3X94R)</b>			
Interface	USB		
Light Transmission	Over 80%		
<b>Touch Screen – Projected Capacitive Type (APC-3X94P)</b>			
Interface	USB		
Light Transmission	Over 90%		
<b>Power</b>			
Power Input	9~36V DC		
Power Consumption	MAX:22.2W(APC-3594P) MAX:18.1W(APC-3594R)	MAX:24.8W(APC-3794P) MAX:25.9W(APC-3794R)	MAX:27.6W(APC-3994P) MAX:26.6W(APC-3994R)
<b>Mechanical</b>			
Construction	Stainless Steel Chassis		
IP Rating	Full IP66/IP69K Design		
Mounting	Panel Mount/ VESA Mount 75 x 75/ Wall Mount	Panel Mount/ VESA Mount 75 x 75/ Wall Mount	Panel Mount/ VESA Mount 100 x 100/ Wall Mount
Dimension	399 x 324 x 58.8 mm	432 x 358 x 58.8	470 x 388.6 x 60.8
Net Weight	5.3 Kg	7.1 Kg	7.6 Kg
<b>Environmental</b>			
Operating temperature	0~50°C -20~60°C (with Industrial SSD) for 15" and 17"		
Storage temperature	-30~70°C		
Storage humidity	10 to 90% @ 40°C, non- condensing		
Certification	CE / FCC Class A		
<b>Operating System Support</b>			
OS Support	Windows 7 Professional for Embedded Systems, Windows 7 Ultimate for Embedded Systems, Windows Embedded 8.1 Pro, Windows Embedded 8.1 Industry Pro		

### 1.3 Dimensions

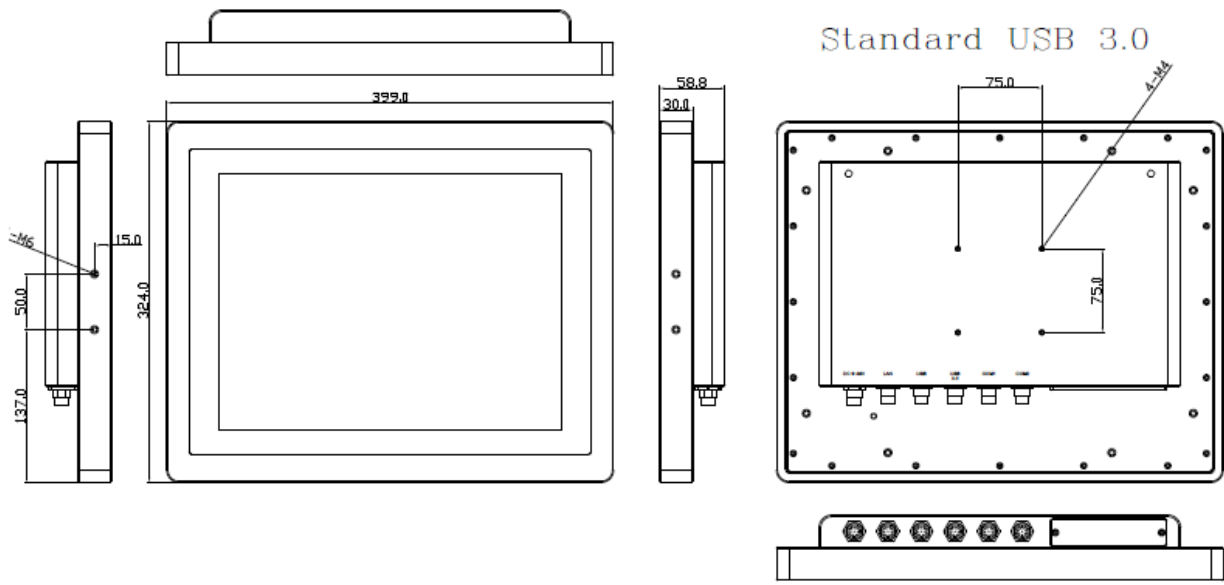

Mounting Hole Size UNIT: mm  
Tolerance: ±0.5

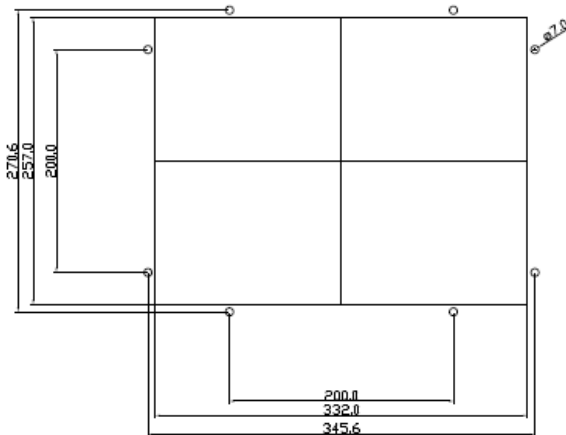

Optional I/O (either one)

USB 2.0

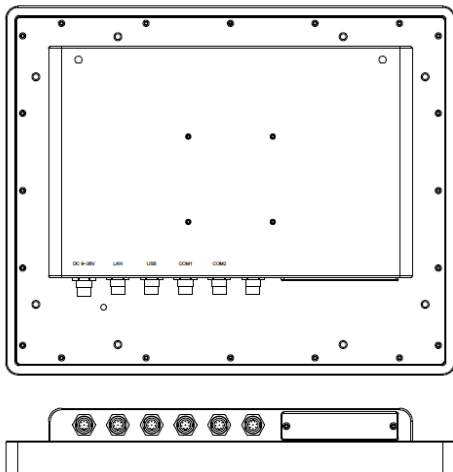

Power Switch

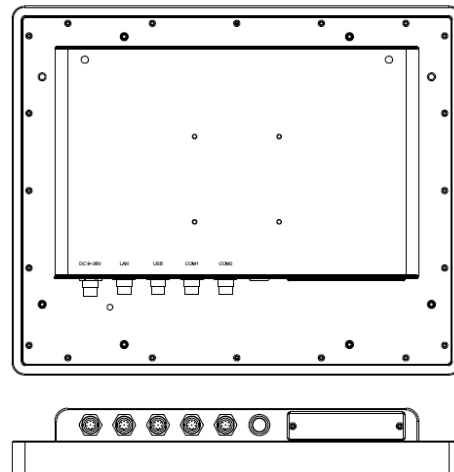

**Figure 1.1: Dimensions of APC-3594P/R – Standard & Optional I/O**  
APC-3X94P/R User Manual

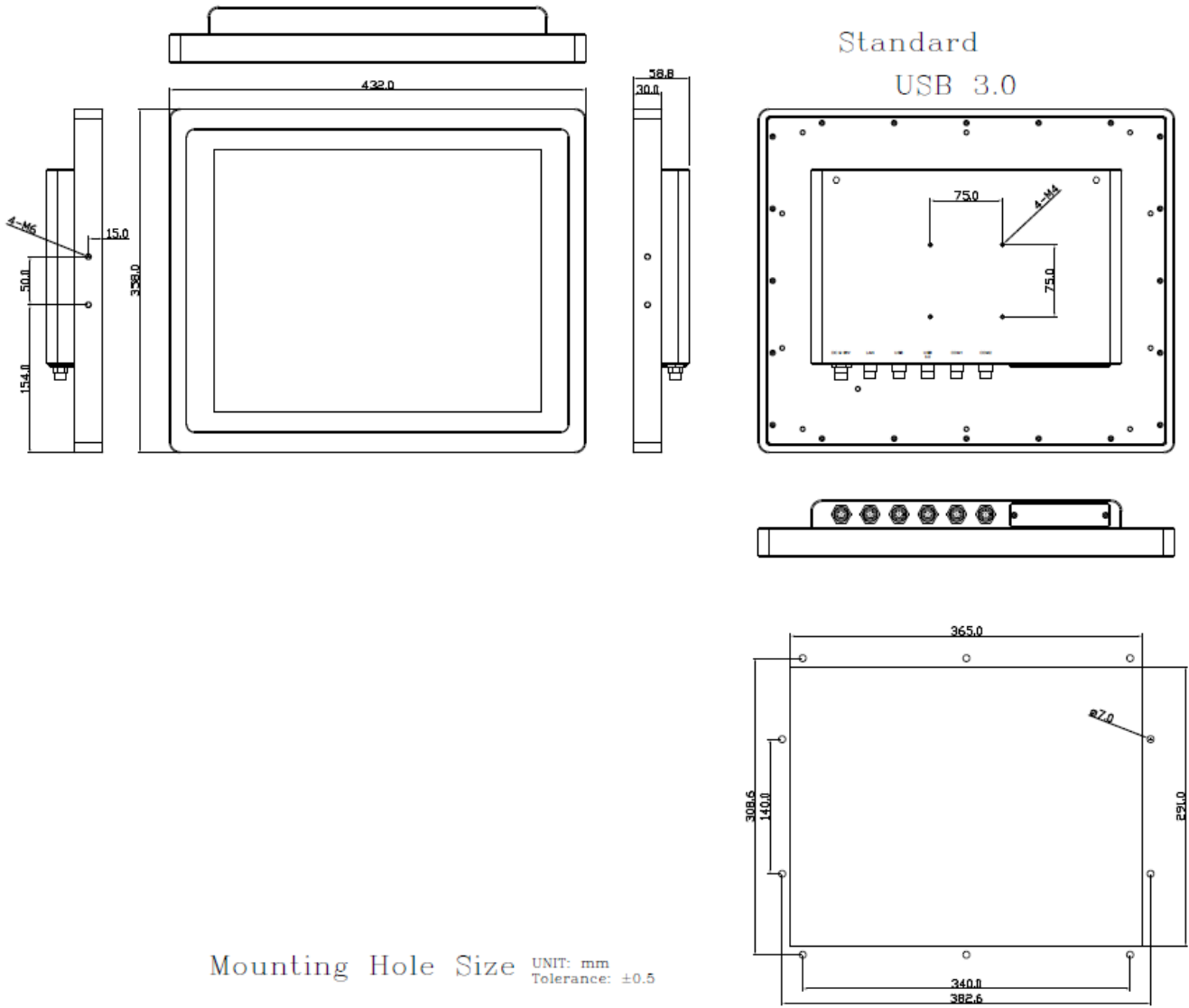

Optional I/O (either one)  
USB 2.0

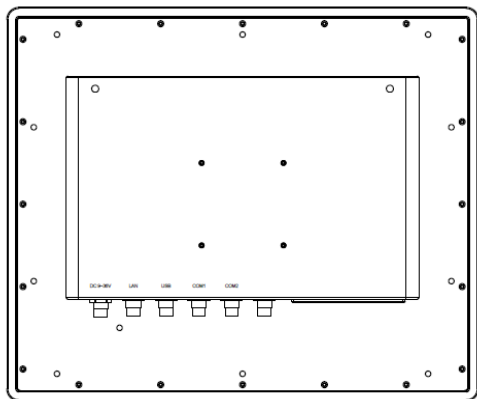

Power Switch

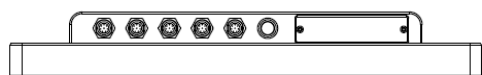
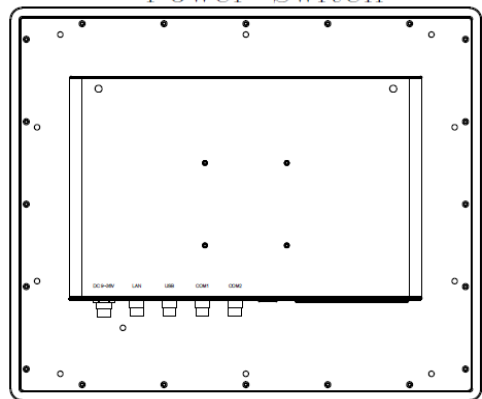

**Figure 1.2: Dimensions of APC-3794P/R – Standard & Optional I/O**

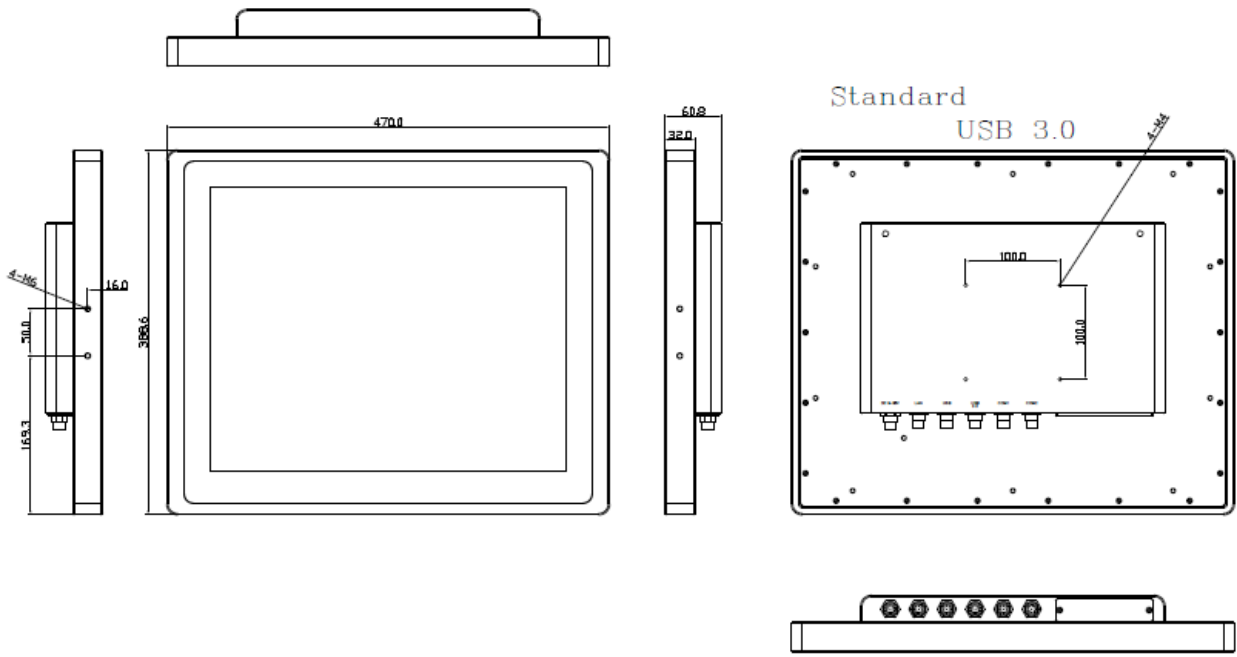

Mounting Hole Size UNIT: mm  
Tolerance:  $\pm 0.5$

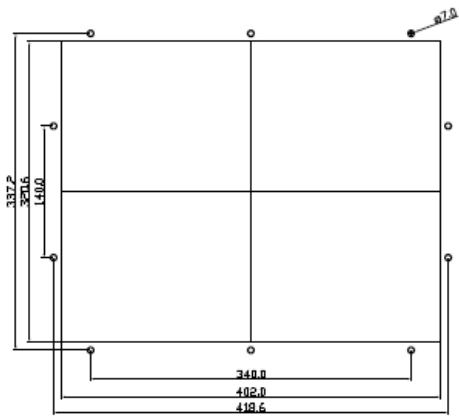

Optional I/O (either one)  
USB 2.0

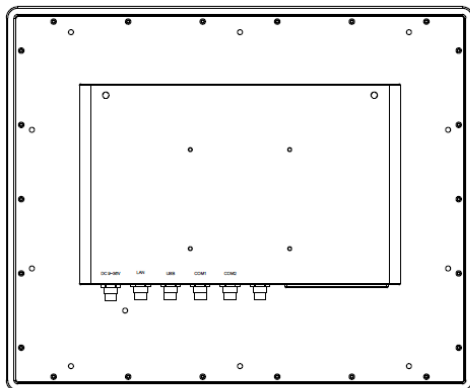

Power Switch

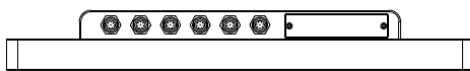
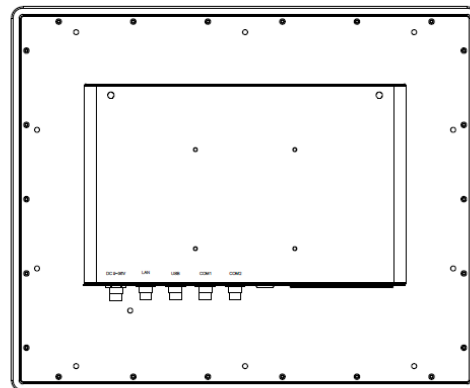

**Figure 1.3: Dimensions of APC-3994P/R – Standard & Optional I/O**

## 1.4 Brief Description of APC-3X94P/R

APC-3X94P/R series come with 15", 17", and 19" color TFT LCD, full IP66/IP69K rated with M12 connector design, and powered by Intel® Celeron® Processor N2930. The model supports onboard DDR3L 4GB 1333/1600MHz memory, and comes with DC 9~36V wide-ranging power input. The model is SUS 304 grade stainless steel enclosure, and SUS 316 stainless steel is for option. It comes with a resistive touch screen and projected capacitive touch screen for option. APC-3X94P/R can be VESA 75 x 75 mounted for 15" and 17", and VESA 100 x 100 mounted for 19" panel PC. The panel PC has a variety of functions and peripherals. Regarding the storage capability, APC-3X94P/R provides 1 x 2.5" SATA HDD or SSD space, allowing customers to easily access/backup the data.



**Figure 1.4: Front View of APC-3594P/R**



**Figure 1.5: Rear View of APC-3594P/R**

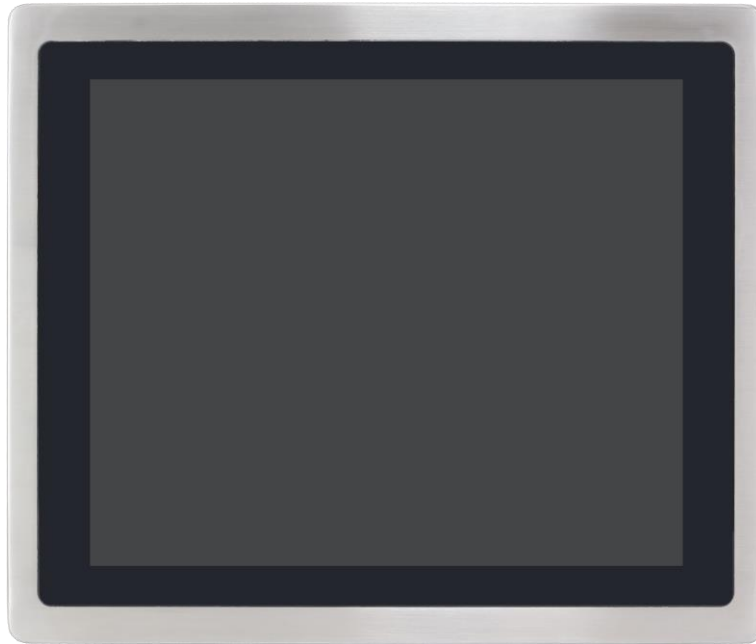

**Figure 1.6: Front View of APC-3794P/R**



**Figure 1.7: Rear View of APC-3794P/R**



**Figure 1.8: Front View of APC-3994P/R**



**Figure 1.9: Rear View of APC-3994P/R**

## 1.5 Installation of HDD/SSD

### Step 1

There are two screws to deal with when enclosing or removing the chassis.

Gently remove two screws.



### Step 2

Take off the HDD cover. Then pull out the HDD bracket like the way shown in the picture.

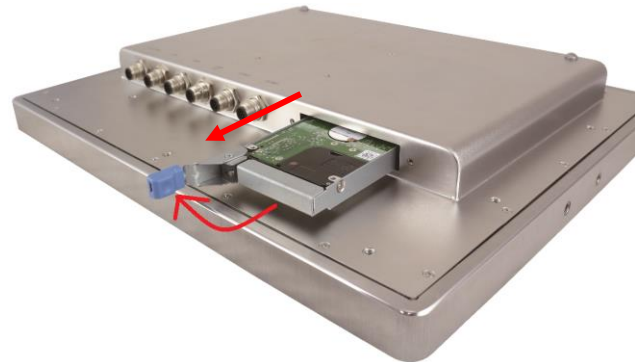

### Step 3

You can replace HDD or SSD by unscrewing four screws as shown in the picture.





## 1.6 Mounting

The APC-3X94P/R series panel PC is designed to be panel-mounted as shown in Figure 1.10. Just carefully place the unit through the hole and tighten the given screws from the rear to secure the mounting.

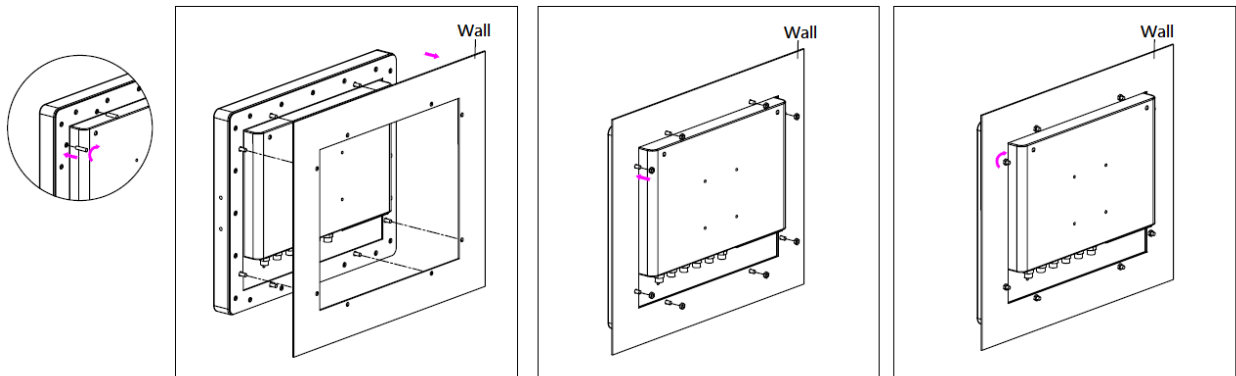

**Figure 1.10: Panel Mounting of APC-3x94P/R**

## 2.1 Motherboard Introduction

SBC-7111 is a 4" industrial motherboard developed on the basis of Intel Bay trail-I/M Processors, which provides abundant peripheral interfaces to meet the needs of different customers. Also, it features dual GbE ports, 3-COM ports and one Mini PCIE configuration, one VGA port, one HDMI port, one LVDS interface. To satisfy the special needs of high-end customers, CN1 and CN2 and CN3 richer extension functions. The product is widely used in various sectors of industrial control.

## 2.2 Specifications

Specifications	
<b>Board Size</b>	170mm x 113mm
<b>CPU Support</b>	Intel Atom E3845 / 1.91GHz (4cores, 10W, option) Intel Atom E3815 / 1.46GHz (1cores, 5W, option) Intel Celeron N2930 / 1.83 up to 2.16GHz (4cores, onboard) Intel Celeron N2807 / 2.16GHz (2cores, option)
<b>Chipset</b>	SoC
<b>Memory Support</b>	Onboard 2GB DDR3L SDRAM (E3845/N2930/E3815/N2807, option) Onboard 4GB DDR3L SDRAM (E3845/N2930/E3815/N2807, option) Onboard 8GB DDR3L SDRAM (E3845/N2930, option)
<b>Graphics</b>	Intel® HD Graphics 542/792MHz (E3845) Intel® HD Graphics 313/854MHz (N2930) Intel® HD Graphics 400MHz (E3815) Intel® HD Graphics 313/750MHz (N2807)
<b>Display Mode</b>	1 x HDMI Port 1 x LVDS (18/24-bit dual LVDS) 1 x CRT Port
<b>Support Resolution</b>	Up to 1920 x 1200 for HDMI Up to 1920 x 1200 for LVDS (PS8625) Up to 1920 x 1200 for CRT
<b>Dual Display</b>	HDMI + LVDS

	HDMI + CRT LVDS + CRT
<b>Super I/O</b>	ITE IT8518E Fintek F81216AD
<b>BIOS</b>	AMI/UEFI
<b>Storage</b>	1 x SATAII Connector (7P) 1 x SATAII Connector (7P + 15P) 1 x SD Slot
<b>Ethernet</b>	2 x PCIe Gbe LAN by Intel 82574L
<b>USB</b>	USB 3.0 Hub(USB5534): 2 x USB 3.0/USB 2.0 (type A)stack ports (E3-USB5/E3-USB6) 1 x USB 2.0 Pin header for CN1 (E3-USB8) 1 x USB 2.0 for USB Touch (E3-USB7) USB 2.0 Hub(USB2514) 1 x USB 2.0 Pin header for CN2 (E-USB9) 2 x USB 2.0 Pin header for CN3 (E-USB10/E-USB11) 1 x USB 2.0 for MPCIE1 (E-USB12)
<b>Touch Ctrl</b>	1 x Touch ctrl header for TCH1 (E3-USB7)
<b>Serial</b>	1 x RS232/RS422/RS485 port, DB9 connector for external (COM1) Pin 9 w/5V/12V/Ring select 1 x RS232 port, DB9 connector for external (COM2) Pin 9 w/5V/12V/Ring select 2 x UART for CN3 (COM3, COM4) 2 x RS422/485 header for CN2 (IT8518E:COM5/COM6)
<b>Digital I/O</b>	8-bit digital I/O by Pin header (CN2) 4-bit digital Input 4-bit digital Output 4-bit digital I/O by Pin header (CN3) 2-bit digital Input 2-bit digital Output
<b>Battery</b>	Support CR2477 Li battery by 2-pin header (BAT1/CMOS)
<b>Audio</b>	Support Audio via Realtek ALC662-VD HD audio codec Support Line-in, LineOut, MIC by 2x6-pin header
<b>Keyboard /Mouse</b>	1 x PS2 keyboard/mouse by box pin header (CN3)

<b>Expansion Bus</b>	1 x mini-PCI-express slot 1 x PCI-express (CN3)
<b>Power Management</b>	Wide Range DC9V~36V input 1 x 3-pin power input connector
<b>POE Power in</b>	DC12V input 1 x 4 Wafer Pin header (DC_IN2)
<b>Switches and LED Indicators</b>	1 x Power on/off switch (BT1/BT2/CN2/CN3) 1 x Reset (CN2) 1 x Power LED status (CN1) 1 x HDD LED status (CN2) 1 x Buzzer
<b>External I/O port</b>	2 x COM Ports (COM1/COM2) 1 x USB 2.0 Port (stack) 2 x USB 3.0/2.0 Ports (stack) 2 x RJ45 GbE LAN Ports 1 x HDMI Port 1 x Stack audio Jack (Line out)
<b>Temperature</b>	Operating: -20°C to 70°C Storage: -40°C to 85°C
<b>Humidity</b>	10% - 90%, non-condensing, operating
<b>Power Consumption</b>	12V /0.80A (Intel Atom E3845 processor with 4GB DDR3L DRAM) 12V /0.60A (Intel Atom E3815 processor with 2GB DDR3L DRAM) 12V /0.70A (Intel Celeron N2930 processor with 4GB DDR3L DRAM) 12V /0.55A (Intel Celeron N2807 processor with 2GB DDR3L DRAM)
<b>EMI/EMS</b>	Meet CE/FCC class A

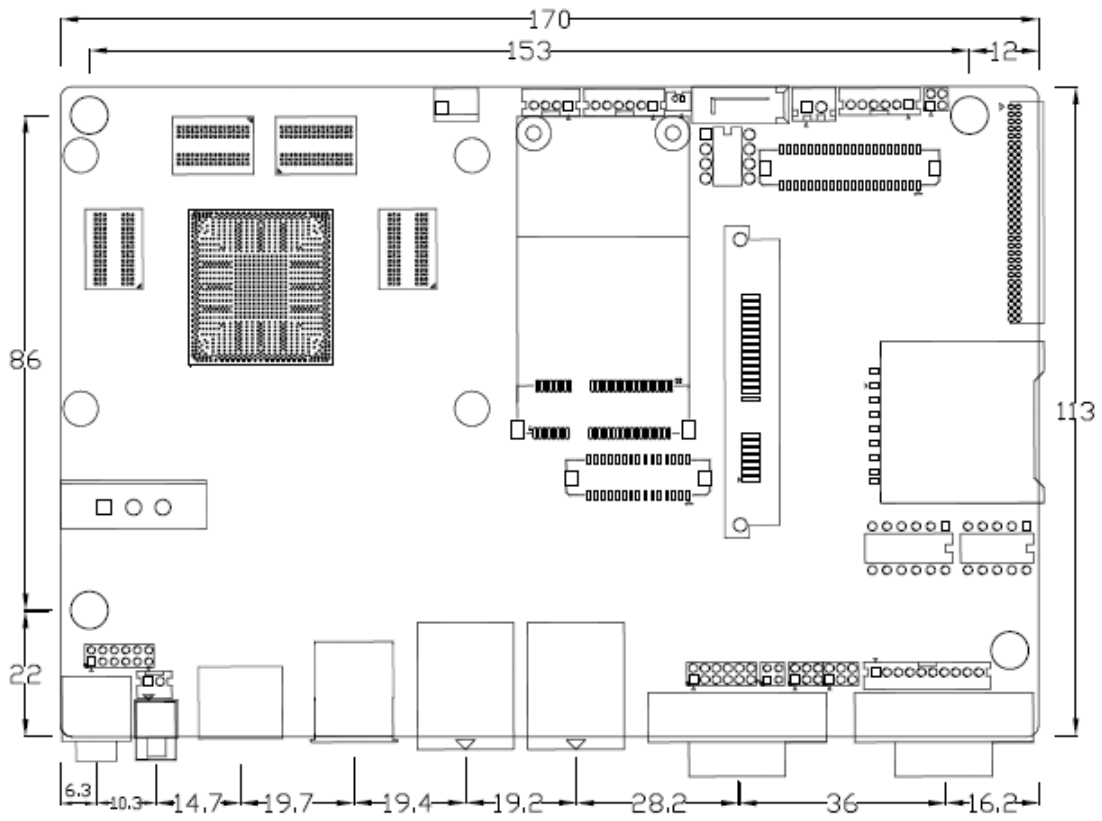

(units :mm)

**Figure 2.1: Motherboard Dimensions**

## 2.3 Jumpers and Connectors Location

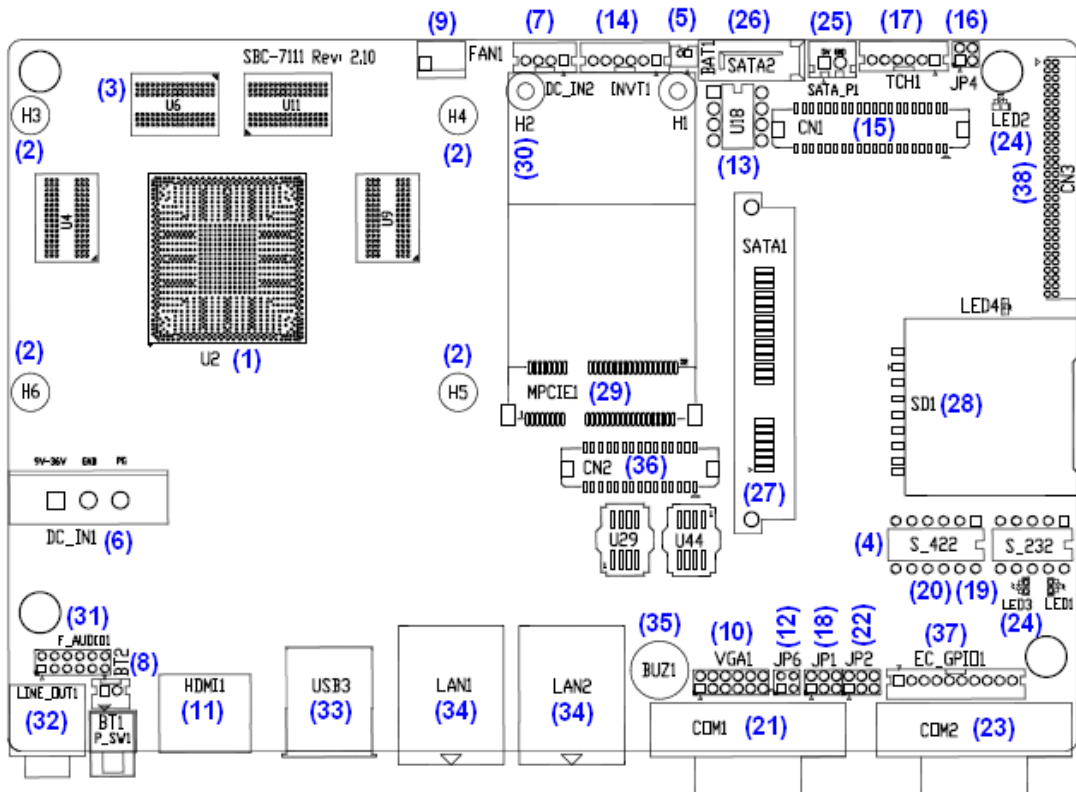

Figure 2.2: Jumpers and Connectors Location- Board Top

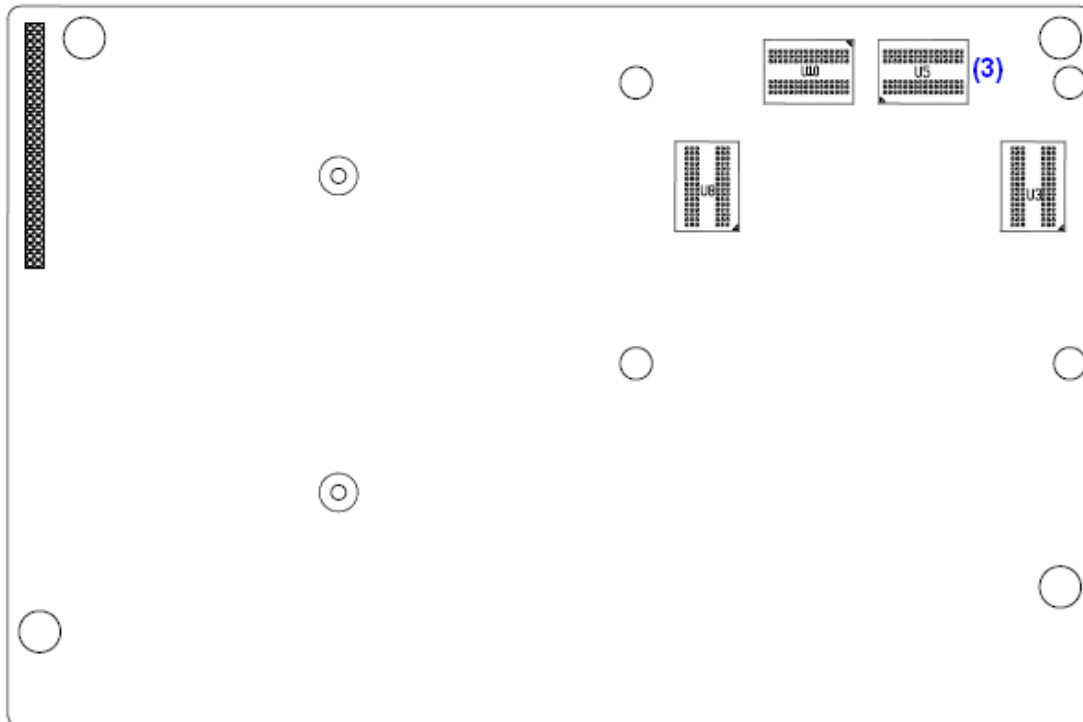

Figure 2.3: Jumpers and Connectors Location- Board Bottom

## 2.4 Jumpers Setting and Connectors

### 1. U2:

(FCBGA1170), onboard Intel Bay trail-I/M Processors.

Model	Processor				
	Number	PBF	Cores/Threads	TDP	Remarks
SBC-7111-N2930-4G	N2930	1.83 up to 2.16GHz	4 / 4	4.5/7.5W	
SBC-7111-E3845-2G	E3845	1.91GHz	4 / 4	10W	Option
SBC-7111-E3845-4G	E3845	1.91GHz	4 / 4	10W	Option
SBC-7111-E3845-8G	E3845	1.91GHz	4 / 4	10W	Option
SBC-7111-N2930-2G	N2930	1.83 up to 2.16GHz	4 / 4	4.5 /7.5W	Option
SBC-7111-N2930P-CN3V-2G	N2930	1.83 up to 2.16GHz	4 / 4	4.5/7.5W	Option
SBC-7111-N2930-8G	N2930	1.83 up to 2.16GHz	4 / 4	4.5/7.5W	Option
SBC-7111-E3815-2G	E3815	1.46GHz	1 / 1	5W	Option
SBC-7111-N2807-2G	N2807	1.58 up to 2.16GHz	2 / 2	2.5/4.3W	option

### 2. H3/H4/H5/H6 (option):

U2 Heat Sink Screw holes, four screw holes for Intel Bay trail-I/M Processors Heat Sink assemble.

### 3. U3/U4/U5/U6/U8/U9/U10/U11:

(FBGA96), Onboard DDR3L Memory.

Model	Memory
SBC-7111-N2930-4G	4GB
SBC-7111-E3845-2G	2GB (option)
SBC-7111-N2930-2G	2GB (option)
SBC-7111-N2930P-CN3V-2G	2GB (option)
SBC-7111-E3815-2G	2GB (option)
SBC-711-N2807-2G	2GB (option)
SBC-7111-E3845-4G	4GB (option)
SBC-7111-E3845-8G	8GB (option)
SBC-7111-N2930-8G	8GB (option)

#### 4. S-422 (PIN6):

(Switch), ATX Power and Auto Power on jumper setting.

S-422(Switch)	Mode
Pin6 (Off)	ATX Power
Pin6 (On)	<b>Auto Power on (Default)</b>

#### 5. BAT1:

(1.25mm Pitch 1x2 Wafer Pin Header) 3.0V Li battery is embedded to provide power for CMOS.

Pin#	Signal Name
1	VBAT
2	Ground

#### 6. DC\_IN1:

(5.08mm Pitch 1x3 Pin Connector), DC9~36V System power input connector.

Pin#	Power Input
1	DC+9V~36V
2	Ground
3	FG

Model	DC_IN1
SBC-7111-E3845-xG	180°Connector
SBC-7111-N2930-xG	180°Connector
SBC-7111-E3815-xG	180°Connector
SBC-7111-N2807-xG	180°Connector
SBC-7111-N2930P-xG	45°Connector
SBC-7111-E3845P-XG	45°Connector
SBC-7111-N2930P-CN3V-XG	45°Connector

#### 7. DC\_IN2:

(2.0mm Pitch 1x4 wafer Pin Header) DC12V POE power input connector.

Pin#	Signal Name
1	VCC_BAT
2	VCC_BAT
3	Ground
4	Ground



SBC-7111 R2.XX	POE Module
DC_IN2	TB-528NE1U2POE/12V OUT (30W)

#### 8. BT1/BT2/P\_SW1:

**Power on/off button**, They are used to connect power switch button. The two pins are disconnected under normal condition. You may short them temporarily to realize system startup & shutdown or awaken the system from sleep state.

BT2	BT1	P_SW1	
●	●	○	<b>Default</b>
●	○	●	Option

#### 9. FAN1(option):

(2.54mm Pitch 1x3 Pin Header), Fan connector, cooling fans can be connected directly for use. You may set the rotation condition of cooling fan in menu of BIOS CMOS Setup.



Pin#	Signal Name
1	Ground
2	VCC
3	Rotation detection



Note:

Output power of cooling fan must be limited under 5W.

#### 10. VGA1:

(CRT 2.0mm Pitch 2x6 Pin Header), Video Graphic Array Port, Provide 2x6Pin cable to VGA Port.

Signal Name	Pin#	Pin#	Signal Name
CRT_RED	1	2	Ground
CRT_GREEN	3	4	Ground
CRT_BLUE	5	6	VGA_EN
CRT_H_SYNC	7	8	CRT_DDCDATA
CRT_V_SYNC	9	10	CRT_DDCCLK
Ground	11	12	Ground

<b>VGA hot plug setting:</b>	
VGA1 (Pin Header)	Function
Pin4-Pin6 (Close)	VGA Simulation Disabled
Pin4-Pin6 (Open)	VGA Simulation Enabled
Use the 2.0mm jumper cap to close pin4 and pin6	

**11. HDMI1:**

(HDMI 19P Connector), High Definition Multimedia Interface connector.

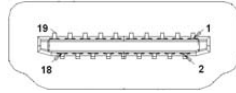

**12. JP6:**

(2.0mm Pitch 2x2 Pin Header), LVDS jumper setting.

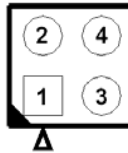

JP6	Function (CN1)
Pin1-Pin2 (Close)	Single channel LVDS
<b>Pin1-Pin2 (Open)</b>	<b>Dual channel LVDS (Default)</b>
<b>Pin3-Pin4 (Close)</b>	<b>8/24 bit (Default)</b>
Pin3-Pin4 (Open)	6/18 bit

**13. U18:**

AT24C02-DIP8, The EEPROM IC (U18) is the set of LVDS resolution. If you need other resolution settings, please upgrade U18 data.

Model	LVDS resolution
SBC-7111-N2930-4G	1280*1024 (Default)
SBC-7111-E3845-2G	800*480 (option)
SBC-7111-E3845-4G	800*600 (option)
SBC-7111-N2930-2G	1024*768 (option)
SBC-7111-E3845-4G	1920*1080 (option)
SBC-7111-E3815-2G	

**14. INVT1:**

(2.0mm Pitch 1x6 wafer Pin Header), Backlight control connector for LVDS.

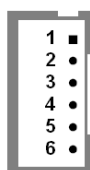

Pin#	Signal Name
1	+DC12V
2	+DC12V
3	Ground
4	Ground
5	BKLT_EN_OUT
6	BKLT_CTRL

**15. CN1:**

(1.25mm Pitch 2x20 Connector, DF13-40P), for 18/24-bit LVDS output connector, fully supported by Parad PS8625(DP to LVDS), the interface features dual channel 24-bit output. Low Voltage Differential Signaling, A high speed, low power data transmission standard used for display connections to LCD panels.

Function	Signal Name	Pin#	Pin#	Signal Name	Function
LVDS	12V_S0	2	1	12V_S0	LVDS
	BKLT_EN_OUT	4	3	BKLT_CTRL	
	Ground	6	5	Ground	
	LVDS_VDD5	8	7	LVDS_VDD5	
	LVDS_VDD3	10	9	LVDS_VDD3	
	Ground	12	11	Ground	
	LA_D0_P	14	13	LA_D0_N	
	LA_D1_P	16	15	LA_D1_N	
	LA_D2_P	18	17	LA_D2_N	
	LA_D3_P	20	19	LA_D3_N	
	LA_CLKP	22	21	LA_CLKN	
	LB_D0_P	24	23	LB_D0_N	
	LB_D1_P	26	25	LB_D1_N	
	LB_D2_P	28	27	LB_D2_N	
LB_D3_P	30	29	LB_D3_N		
LB_CLKP	32	31	LB_CLKN		
	Ground	34	33	Ground	E3_USB8 (USB2.0)
D3_USB3 (USB2.0)	E3_USB8_P	36	35	E3_USB8_N	
	5V_S5_USB	38	37	5V_S5_USB	
Power LED	PWR_LED+	40	39	Ground	Power LED

**16. JP4:**

(2.0mm Pitch 2x2 wafer Pin Header), Touch jumper setting.

JP4	Touch (TCH1)
Close 1-2 <b>(default)</b>	-
Open 3-4 <b>(default)</b>	-
Close 3-4 (option)	Hardware Enabled

**17. TCH1:**

(2.0mm Pitch 1x6 wafer Pin Header), internal Touch controller connector.

Pin#	Signal Name
1	SENSE
2	X+
3	X-
4	Y+
5	Y-
6	GND_EARCH

**18. JP1:**

(2.0mm Pitch 2x3 Pin Header), COM1 jumper setting, pin 1~6 are used to select signal out of pin 9 of COM1 port.

JP1 Pin#	Function
<b>Close 1-2</b>	<b>COM1 RI (Ring Indicator) (default)</b>
Close 3-4	COM1 Pin9: DC+5V (option)
Close 5-6	COM1 Pin9: DC+12V (option)

**19. S\_232:**

(Switch), COM1 jumper setting, it provides selectable RS232 or RS422 or RS485 serial signal output.

Function	S_232 Pin#
<b>RS232 (Default)</b>	<b>ON: Pin1, Pin2, Pin3, Pin4</b>
RS422 (option)	OFF: Pin1, Pin2, Pin3, Pin4
RS485 (option)	OFF: Pin1, Pin2, Pin3, Pin4

**20. S\_422:**

(Switch), COM1 setting, it provides selectable RS232 or RS422 or RS485 serial signal output.

Function	S_422 Pin#
<b>RS232 (Default)</b>	<b>OFF: Pin1, Pin2, Pin3, Pin4, Pin5</b>
RS422 (option)	ON: Pin1, Pin2, Pin3, Pin4, Pin5
RS485 (option)	ON: Pin1, Pin2, Pin3, Pin4, Pin5

S-422	Mode
Pin6 (Off)	Manual Power on
Pin6 (On)	<b>Auto Power on (Default)</b>

## 21. COM1:

**(Type DB9M)**, Rear serial port, standard DB9 Male serial port is provided to make a direct connection to serial devices. COM1 port is controlled by pins No.1~6 of JP1, select output Signal RI or 5V or 12V, for details, please refer to description of JP1 and S\_232 and S\_422 setting.

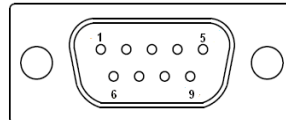

<b>RS232 (Default)</b>	
Pin#	Signal Name
1	DCD# (Data Carrier Detect)
2	RXD (Received Data)
3	TXD (Transmit Data)
4	DTR (Data Terminal Ready)
5	Ground
6	DSR (Data Set Ready)
7	RTS (Request To Send)
8	CTS (Clear To Send)
9	<b>JP1 select Setting (RI/5V/12V)</b>
BIOS Setup: Advanced/F81216SEC Super IO Configuration/Serial Port 1 Configuration <b>【RS-232】</b>	

<b>RS422 (option)</b>	
Pin#	Signal Name
1	422_RX+
2	422_RX-
3	422_TX-
4	422_TX+

5	Ground
6	NC
7	NC
8	NC
9	NC
BIOS Setup: Advanced/F81216SEC Super IO Configuration/Serial Port 1 Configuration 【RS-422】	

RS485 (option)	
Pin#	Signal Name
1	NC
2	NC
3	485-
4	485+
5	Ground
6	NC
7	NC
8	NC
9	NC
BIOS Setup: Advanced/F81216SEC Super IO Configuration/Serial Port 1 Configuration 【RS-485】	

**22. JP2:**

(2.0mm Pitch 2x3 Pin Header), COM2 jumper setting, pin 1~6 are used to select signal out of pin 9 of COM2 port.

JP2 Pin#	Function
<b>Close 1-2</b>	<b>COM2 RI (Ring Indicator) (default)</b>
Close 3-4	COM2 Pin9: DC+5V (option)
Close 5-6	COM2 Pin9: DC+12V (option)

**23. COM2:**

**(Type DB9M)**, Rear serial port, standard DB9 Male serial port is provided to make a direct connection to serial devices.

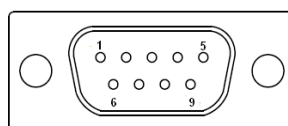

Pin#	Signal Name
1	DCD# (Data Carrier Detect)
2	RXD (Received Data)
3	TXD (Transmit Data)
4	DTR (Data Terminal Ready)
5	Ground
6	DSR (Data Set Ready)
7	RTS (Request To Send)
8	CTS (Clear To Send)
9	<b>JP2 select Setting (R1/5V/12V)</b>

**24. LED1, LED2 (option) :**

LED1: LED STATUS. Green LED for Power Good status.

LED2: LED STATUS. Green LED for Touch Power Status.

LED3: LED STATUS. Green LED for EC Power status.

LED4: LED STATUS. Green LED for Motherboard Standby Power Good status.

**25. SATA\_P(option):**

(2.5mm Pitch 1x2 box Pin Header), One onboard 5V output connector are reserved to provide power for SATA devices.

Pin#	Signal Name
1	+DC5V
2	Ground



**Note:**

**Output current of the connector must not be above 1A.**

**26. SATA2(option):**

(SATA 7Pin), SATA Connectors, one SATA connector are provided, with transfer speed up to 3.0Gb/s.

**27. SATA1:**

(SATA 7Pin+15Pin), SATA Connectors, one SATA connector are provided, with transfer speed up to 3.0Gb/s.

**28. SD1:**

(SD card slot), Secure Digital Memory Card socket.

**29. MPCIE1:**

(Socket 52Pin), mini PCIe socket, it is located at the top, it supports mini PCIe devices with USB2.0 and LPC and SMBUS and PCIe signal. MPCIE card size is 30x50.95mm.

**30. H1/H2:**

MPCIE1 SCREW HOLES, H1and H2 for mini PCIE card (30mmx50.95mm) assemble.

**31. F\_AUDIO1:**

(2.0mm Pitch 2X6 Pin Header), Front Audio, An onboard Realtek ALC662-VD codec is used to provide high-quality audio I/O ports. Line Out can be connected to a headphone or amplifier. Line In is used for the connection of external audio source via a Line in cable. MIC is the port for microphone input audio.

Signal Name	Pin#	Pin#	Signal Name
+5V	1	2	GND_AUD
LINE-OUT-L	3	4	LINE-OUT-R
FRONT_JD	5	6	LINE1_JD
LINE_IN-L	7	8	LINE-IN-R
MIC-IN-L	9	10	MIC-IN-R
GND-AUD	11	12	MIC1_JD

**32. LINE\_OUT1:**

(Diameter 3.5mm Jack), HD Audio port, an onboard Realtek ALC662-VD codec is used to provide high quality audio I/O ports. Line Out can be connected to a headphone or amplifier.

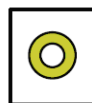

Line out

**33. USB3:**

**USB3-5/USB3-6:** (Double stack USB type A), Rear USB connector, it provides up to two USB3.0 port, support USB full-speed and low-speed signaling.

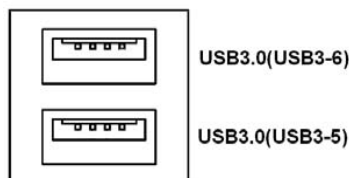

**Each USB Type A Receptacle (2 Ports) Current limited value is 2.0A.**

**If the external USB device current exceeds 2.0A, please separate connectors into different Receptacle.**



**34. LAN1/LAN2:**

**LAN1/LAN2:** (RJ45 Connector), Rear LAN port, Two standard 10/100/1000M RJ-45 Ethernet ports are provided. Used intel 82574L chipset, LINK LED (green) and ACTIVE LED (yellow) respectively located at the left-hand and right-hand side of the Ethernet port indicate the activity and transmission state of LAN.

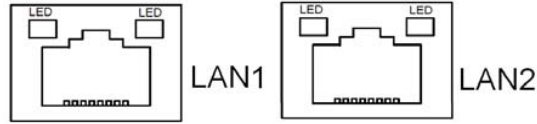

**35. BUZ1:**

Onboard buzzer.

**36. CN2:**

(DF13-30P Connector) For expand output connector, It provides eight GPIO, one RS422 or RS485, one USB2.0, one Power on/off, one Reset.

Function	Signal Name	Pin#	Pin#	Signal Name	Function
5V	5V_S5	2	1	5V_S5	5V
SOC_GPIO10	GPIO_IN2	4	3	GPIO_IN1	SOC_SPIO09
SOC_GPIO26	GPIO_IN4	6	5	GPIO_IN3	SOC_GPIO17
SOC_GPIO05	GPIO_OUT2	8	7	GPIO_OUT1	SOC_GPIO04
SOC_GPIO08	GPIO_OUT4	10	9	GPIO_OUT3	SOC_GPIO06
	Ground	12	11	Ground	
485 or 422	485+_422TX+	14	13	485-_422TX5-	485 or 422
RS422	422_RX+	16	15	422_RX5-	RS422
485 or 422	485+_422TX6+	18	17	485-_422TX6-	485 or 422
RS422	422_RX6+	20	19	422_RX6-	RS422
5V	5V_S0	22	21	HDD_LED+	HDD LED
USB2.0	5V_USB09	24	23	5V_USB01	USB2.0
	E_USB9_P	26	25	E_USB9_N	
	Ground	28	27	FP_RST-	RESET
Power auto on	PWRBTN_ON	30	29	Ground	

COM5/COM6 BIOS Setup:

Advanced/IT8518Super IO Configuration/Serial Port 1 Configuration **【RS-485】**

Advanced/IT8518Super IO Configuration/Serial Port 1 Configuration **【RS-422】**

Advanced/IT8518Super IO Configuration/Serial Port 2 Configuration **【RS-485】**

Advanced/IT8518Super IO Configuration/Serial Port 2 Configuration **【RS-422】**

**37. EC\_GPIO1:**

(2.0mm Pitch 1X10 Pin Header)For expand connector, it provides brightness adjustment function.

Pin#	Signal Name
1	Ground
2	GPA0_ONOFF
3	GPA1_SPK-
4	GPE6_BKLT-
5	GPE0_BKLT+
6	SPKGPC3_SPK+
7	BKL_CTRL_PWR
8	ADC6_BKLT_CTRL
9	ADC7_L_SENSE
10	3.3V

**38. CN3:**

(1.27mm Pitch 2X30 Female Header), for expand output connector, it provides four GPIO, two USB 2.0,one PS/2 mouse, one PS/2 keyboard, two uart, one PCIe1, one SMBus. connected to the TB-528 riser Card.

Function	Signal Name	Pin#	Pin#	Signal Name	Function
	5V_S5_USB	1	2	5V_S5_USB	
	5V_S5_USB	3	4	5V_S5_USB	
	USB1011_OC	5	6	PSON_ATX-	
E-USB10	E_USB10_N	7	8	E_USB10_P	E-USB10
E-USB11	E_USB11_N	9	10	E_USB11_P	E-USB11
	Ground	11	12	Ground	
PS/2 MS	PS2_MSCLK	13	14	PS2_MSDATA	PS/2 MS
PS/2 KB	PS2_KBCLK	15	16	PS2_KBDATA	PS/2 KB
COM4 (UART)	COM4_RI	17	18	COM4_DCD-	COM4 (UART)
	COM4_TXD	19	20	COM4_RXD	
	COM4_DTR	21	22	RICOM4_RTS-	
	COM4_DSR	23	24	COM_CTS-	
	Ground	25	26	Ground	
COM3 (UART)	COM3_RI	27	28	COM3_DCD-	COM3 (UART)
	COM3_TXD	29	30	COM3_RXD	
	COM3_DTR	31	32	DSRCOM3_RTS-	

	COM3_DSR	33	34	DTRCOM3_CTS-	
GPIO23	SOC_GPIO23	35	36	ICH_GPIO22	GPIO12
GPIO25	SOC_GPIO25	37	38	ICH_GPIO24	GPIO24
	Ground	39	40	Ground	
PCIE	PCIE_TX0_DN	41	42	PCIE_TX0_DP	PCIE
	PCIE_RX0_DN	43	44	PCIE_RX0_DP	
	Ground	45	46	Ground	
	PCIE_REFCLK0_DN	47	48	PCIE_REFCLK0_DP	
	PCIE0_WAKE_N	49	50	PLTRST_3P3_N	
SMBUS	SMB_CLK_S0	51	52	SMB_DATA_S0	SMBUS
PCIE	PCIE_CLKREQ0_N	53	54	Ground	
	3P3V_S5	55	56	PWRBTN_ON-	Power Auto on
	3P3V_S5	57	58	3P3V_S5	
12V	12V_S0	59	60	12V_S0	12V

## 3.1 Operations after POST Screen

After CMOS discharge or BIOS flashing operation, press [Delete] key to enter CMOS Setup.

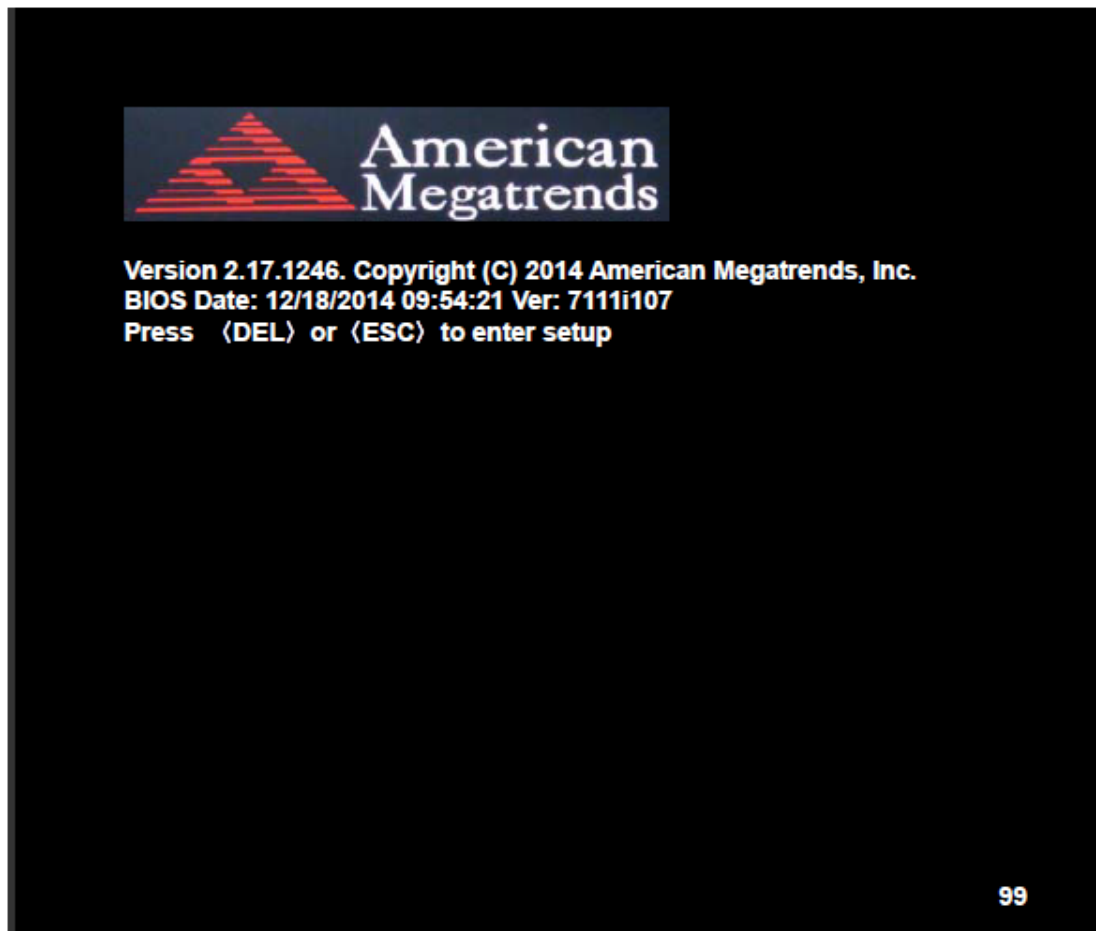

After optimizing and exiting CMOS Setup, the POST screen displayed for the first time is as follows and includes basic information on BIOS, CPU, memory, and storage devices.

## 3.2 BIOS Setup Utility

Press [Delete] key to enter BIOS Setup utility during POST, and then a main menu containing system summary information will appear.

### 3.3 Main Settings

Aptio Setup Utility – Copyright (C) 2014 American Megatrends, Inc.					
Main	Advanced	Chipset	Security	Boot	Save & Exit
BIOS Information					Choose the system default Language
BIOS Vendor	American Megatrends				
Core Version	5.010				
Compliance	UEFI 2.4; PI 1.3				
Project Version	7111i 1.07 x64				
Build Date and Time	12/18/2014 09:54:21				
CPU Configuration					
Microcode Patch	901				
BayTrail SoC	DO Stepping				
KSC Information					
KSC Version	N/A				
Memory Information					
Total Memory	4096 MB (DDR3L)				
GOP Information					
Intel (R) GOP Driver	[N/A]				
TXE Information					→←: Select Screen
Sec RC Version	00.05.00.00		↑↓ : Select Item		
TXE FW Version	01.01.00.1089		Enter: Select		
System Language	[English]		+/- : Change Opt.		
System Date	[Sun 01/01/2012]		F1 : General Help		
System Time	[00:00:10]		F2: Previous Values		
					F3:Optimized Defaults
					F4:Save and Exit
					ESC Exit
Version 2.17.1246. Copyright (C) 2014 American Megatrends , Inc.					

#### System Time:

Set the system time, the time format is:

Hour : 0 to 23

Minute : 0 to 59

Second : 0 to 59

### System Date:

Set the system date, the date format is:

**Day:** Note that the 'Day' automatically changes when you set the date.

**Month:** 01 to 12

**Date:** 01 to 31

**Year:** 1998 to 2099

## 3.4 Advanced Settings

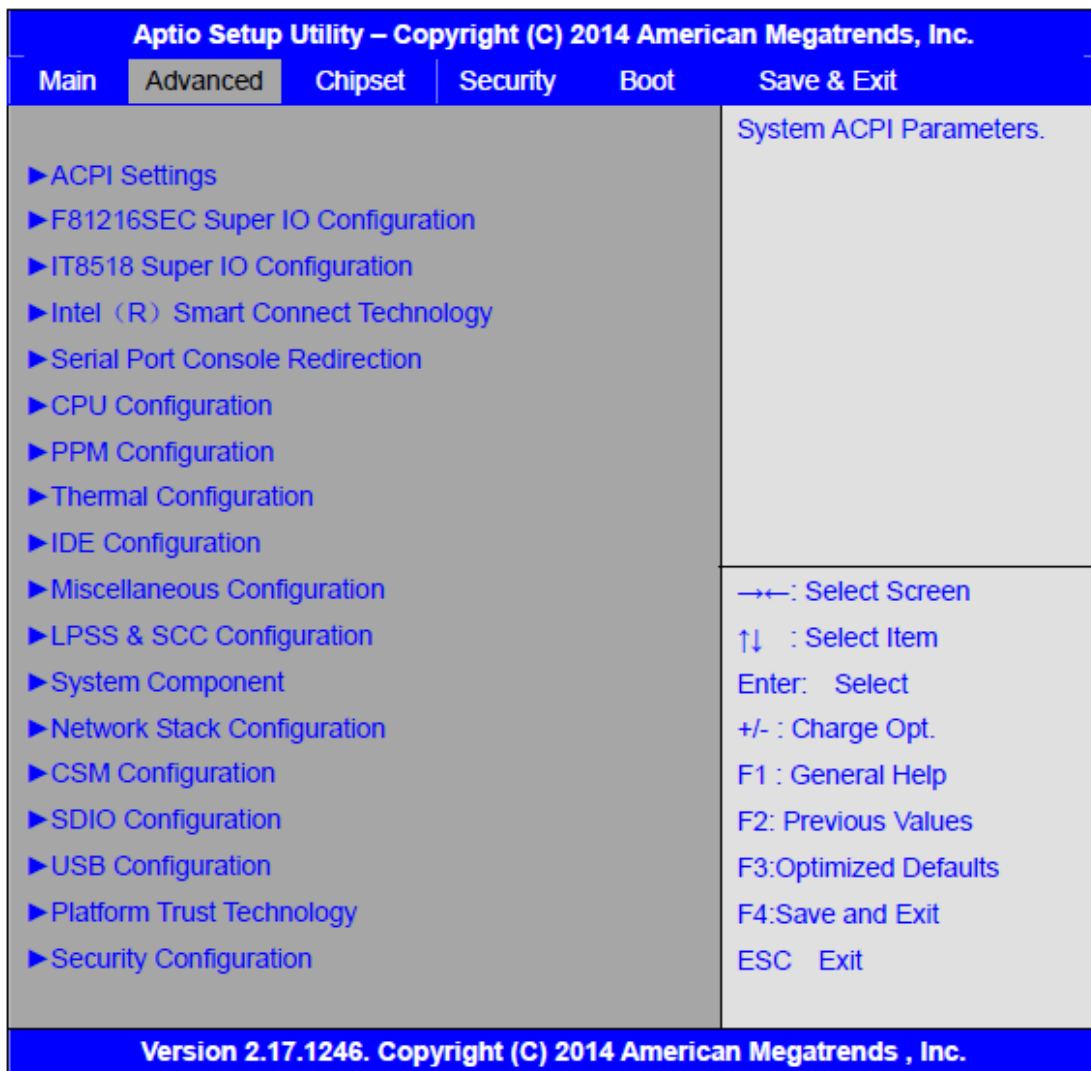

### 3.4.1 ACPI Settings

**Enable ACPI Auto Conf:**

**[Disabled]**

[Enabled]

**Enable Hibernation:**

[Enabled]

[Disabled]

**ACPI Sleep State:**

[S3 (Suspend to RAM) ]

[Suspend Disabled]

**Lock Legacy Resources:**

[Disabled]

[Enabled]

**3.4.2 F81216SEC Super IO Configuration**

Super IO chip F81216SEC

Serial Port 1 Configuration

UART1 Mode Selection:

[RS-232]

[RS-485]

[RS-422]

Serial Port 2 Configuration

Change Settings [Auto]

Serial Port 3 Configuration

Change Settings [Auto]

Serial Port 4 Configuration

Change Settings [Auto]

**3.4.3 IT8518 Super IO Configuration**

Super IO chip IT8518/IT8519

Serial Port 1 Configuration

Backlight PWM Controller (COM5) :

[RS-485]

[RS-422]

Serial Port 2 Configuration (COM6)

Change Settings [Auto]

**3.4.4 Intel (R) Smart Connect Technology**

ISCT Support

[Disabled]

[Enabled]

### 3.4.5 Serial Port Console Redirection

COM0

Console Redirection

[Disabled]

[Enabled]

Console Redirection Settings

Legacy Console Redirection

Legacy Console Redirection settings

Serial Port for Out-of-Band Management/

Windows Emergency Management Services (EMS)

Console Redirection

[Disabled]

[Enabled]

Console Redirection Settings

### 3.4.6 CPU Configuration

#### Socket 0 CPU Information

Intel(R) Atom(TM) CPU E3845 @ 1.91GHz

CPU Signature	30679
Microcode Patch	901
Max CPU Speed	1910 MHz
Mix CPU Speed	500 MHz
Processor Cores	4
Intel HT Technology	Not Supported
Intel HT-X Technology	Supported
L1 Data Cache	24KB x 4
L1 Code Cache	32KB x 4
L2 Cache	1024KB x 2
L2 Cache	Not Present

CPU Thermal configuration

CPU Speed	1918 MHz
64-bit	Supported
Hyper-Threading:	[Enabled]
	[Disabled]



Limit CPUID Maximum:	<b>[Disabled]</b> [Enabled]
Execute Disable Bit:	<b>[Enabled]</b> [Disabled]
Intel Virtualization Technology:	<b>[Enabled]</b> [Disabled]
Power Technology	<b>[Energy Efficient]</b> [Disabled] [Custom]

### 3.4.7 PPM Configuration

CPU C State Report	<b>[Enabled]</b> [Disabled]
Max CPU C-state	<b>[C7]</b> [C6] [C1]
SOix	<b>[Disabled]</b> [Enabled]

### 3.4.8 Thermal Configuration Parameters

#### 3.4.9 IDE Configuration

Serial-ATA(SATA)	<b>[Enabled]</b> [Disabled]
SATA Test Mode	<b>[Disabled]</b> [Enabled]
SATA Speed Support	[Gen2] [Gen1]

SATA ODD Port	[No ODD] [Port0 ODD] [Port1 ODD] [Disabled]
<b>SATA Mode</b>	[AHCI Mode] [IDE Mode]
Serial-ATA Port 0	[Enabled] [Disabled]
SATA Port0 Hotplug	[Disabled] [Enabled]
Serial-ATA Port 1	[Enabled] [Disabled]
SATA Port1 Hotplug	[Disabled] [Enabled]
SATA Port0	Not Present
SATA Port1	Not Present

### 3.4.10 Miscellaneous Configuration

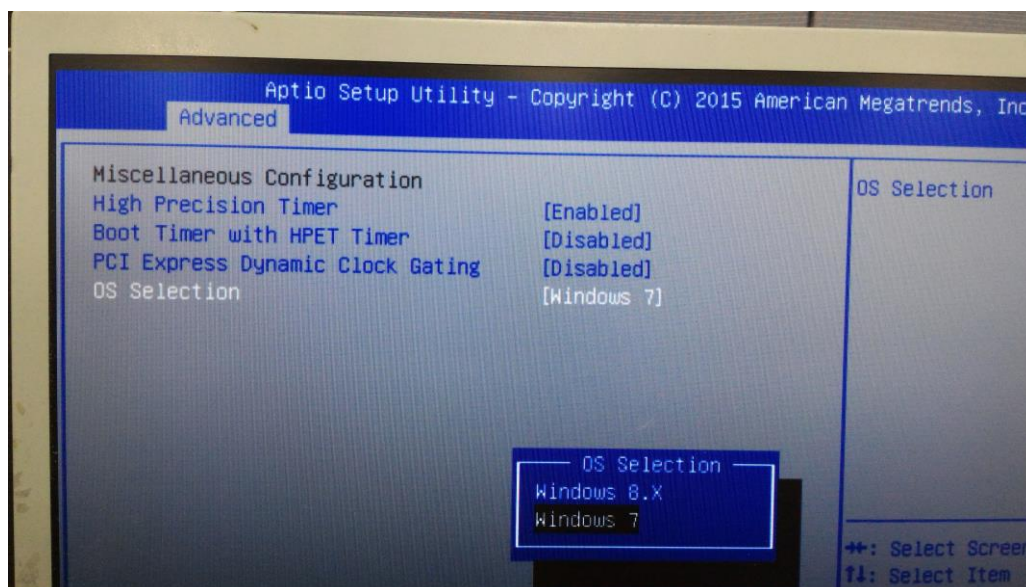

High Precision Timer	[Enabled]
	[Disabled]
Boot Timer with HPET Timer	[Disabled]
	[Enabled]
PCI Express Dynamic Clock Gating	[Disabled]
	[Enabled]

### OS Selection

Use the **OS Selection** option to select an operating system for the system.



**Note:**

**Users must go to this item to select the OS mode before installing corresponding OS driver, otherwise problems will occur when installing the driver.**

#### 3.4.11 LPSS & SCC Configuration

LPSS & SCC Configuration	[ACPI Mode]
SCC Configuration	
SCC eMMC Support	[eMMC AUTO MODE]
SCC eMMC 4.5 DDR50 Support	[Enabled]
SCC eMMC 4.5 HS200 Support	[Disabled]
eMMC Secure Erase	[Disabled]
SCC SDIO Support	[Enabled]
SCC SD Card Support	[Enabled]
SDR25 Support for SDCard	[Disabled]
SDR50 Support for SDCard	[Enabled]
MIPI HSI Support	[Disabled]
LPSS Configuration	
LPSS DMA #1 Support	[Enabled]
LPSS DMA #2 Support	[Enabled]
LPSS I2C #1 Support	[Enabled]
LPSS I2C #2 Support	[Enabled]
LPSS I2C #3 Support	[Enabled]
LPSS I2C #4 Support	[Enabled]

LPSS I2C #5 Support	[Enabled]
LPSS I2C #6 Support	[Enabled]
LPSS I2C #7 Support	[Enabled]
NFC	[Disabled]
Touch Pad	[Disabled]
I2C touch Device Address	
LPSS HSUART #1 Support	[Disabled]
LPSS HSUART #2 Support	[Disabled]
LPSS PWM #1 Support	[Enabled]
LPSS PWM #2 Support	[Enabled]
LPSS SPI Support	[Enabled]

### 3.4.12 System Component

### 3.4.13 Network Stack Configuration

Network Stack	[Disabled]
---------------	------------

### 3.4.14 CSM Configuration

CSM Support	[Enabled]
CSM16 Module Version	07.76
GateA20 Active	[Upon Request] [Always]
Option ROM Messages	[Force BIOS] [Keep Current]
Boot option filter	[UEFI and Legacy] [Legacy only] [UEFI only]
Network	[UEFI] [Do not launch] [Legacy]
Storage	[UEFI] [Do not launch] [Legacy]
Video	[Legacy] [UEFI]

[Do not launch]

Other PCI devices

[UEFI]

[Do not launch]

[Legacy]

### 3.4.15 SDIO Configuration

### 3.4.16 USB Configuration

USB Configuration

USB Module Version 8.11.02

USB Devices:

1 keyboard, 1 Mouse, 2 Hubs

Legacy USB Support:

[Enabled]

[Disabled]

XHCI Hand-off:

[Enabled]

[Disabled]

EHCI Hand-off:

[Disabled]

[Enabled]

USB Mass Storage Driver Support

[Enabled]

[Disabled]

USB hardware delays and time-outs:

USB transfer time-out:

[20 sec]

[10 sec]

[5 sec]

[1 sec]

Device reset time-out:

[20 sec]

[10 sec]

[30 sec]

[40 sec]

Device power-up delay

[Auto]

[Manual]

### 3.4.17 Platform Trust Technology

### 3.4.18 Security Configuration

## 3.5 Chipset Settings

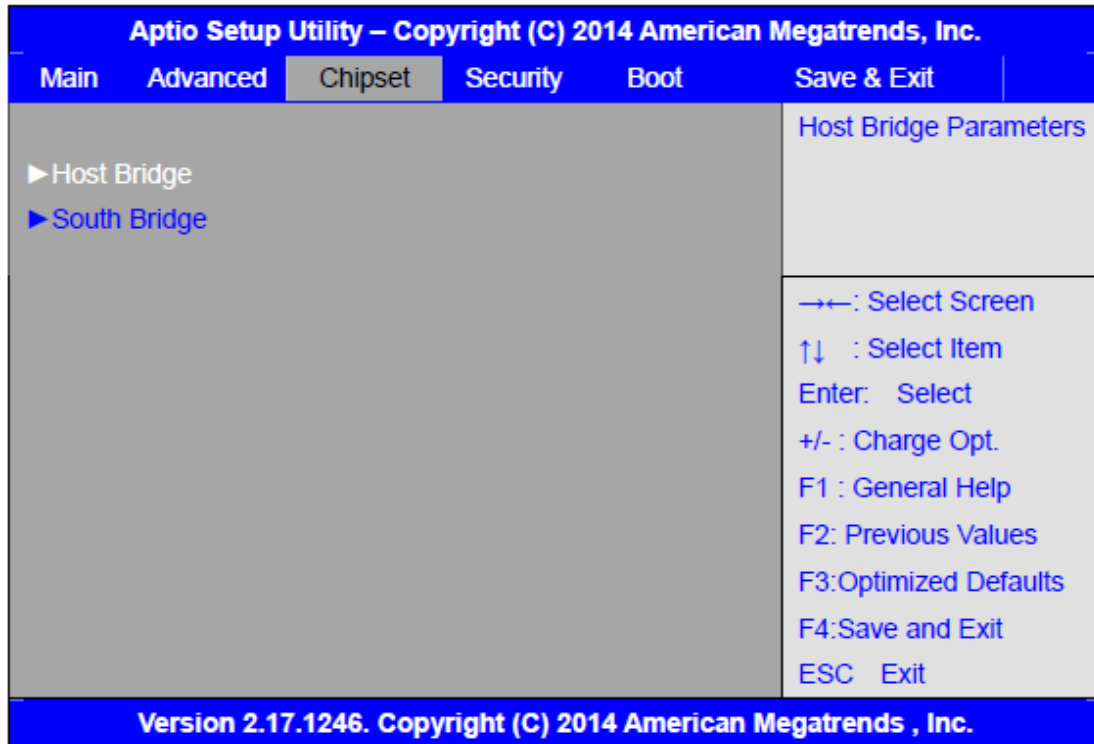

### 3.5.1 Host Bridge

#### ▶ Intel IGD Configuration

#### ▶ IGD – LCD Control

Force Lid Status	[On] [Off]
BIA	[Auto]
ALS Support	[Disabled]
IGD Flat Panel	[Auto]
Pannel Scaling	[Auto]

#### ▶ Memory Frequency and Timing

#### ▶ Graphics Power Management Control

Memory Information	
Total Memory	4096 MB(DDR3L)
Memory Slot0	4096 MB(DDR3L)
DIMM#1	Not Present

Max TOLUD

**[Dynamic]**

[2GB]

[2.25GB]

[2.5GB]

[2.75GB]

[3GB]

### 3.5.2 South Bridge

▶ Azalia HD Audio

▶ USB Configuration

USB OTG Support [Disabled]

USB VBUS [On]

XHCI Mode [Smart Auto]

USB2 Link Power Management [Enabled]

USB 2.0(EHCI) Support [Enabled]

USB EHCI debug [Disabled]

USB Per Port Control [Enabled]

USB Port 0 [Enabled]

USB Port 1 [Enabled]

USB Port 2 [Enabled]

USB Port 3 [Enabled]

## 3.6 Security Settings

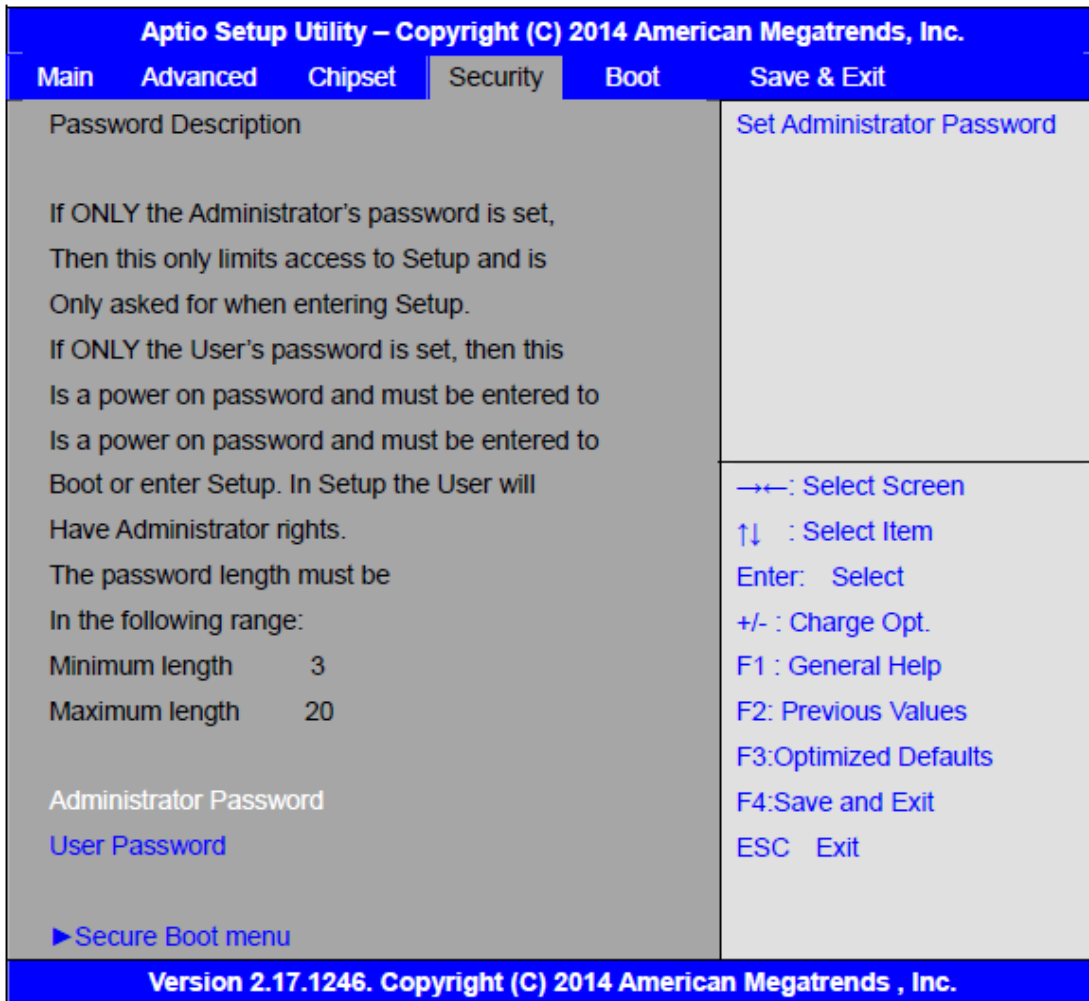

### 3.6.1 Administrator Password



### 3.6.2 User Password



Type the password with up to 20 characters and then press **<Enter>** key. This will clear all previously typed CMOS passwords. You will be requested to confirm the password. Type the password again and press **<Enter>** key. You may press **<Esc>** key to abandon password entry operation.

To clear the password, just press **<Enter>** key when password input window pops up. A confirmation message will be shown on the screen as to whether the password



will be disabled. You will have direct access to BIOS setup without typing any password after system reboot once the password is disabled.

Once the password feature is used, you will be requested to type the password each time you enter BIOS setup. This will prevent unauthorized persons from changing your system configurations.

Also, the feature is capable of requesting users to enter the password prior to system boot to control unauthorized access to your computer. Users may enable the feature in Security Option of Advanced BIOS Features. If Security Option is set to System, you will be requested to enter the password before system boot and when entering BIOS setup; if Security Option is set to Setup, you will be requested for password for entering BIOS setup.

### 3.7 Boot Settings

Aptio Setup Utility – Copyright (C) 2014 American Megatrends, Inc.					
Main	Advanced	Chipset	Security	Boot	Save & Exit
Boot Configuration					Number of seconds to Wait for Setup Activation key.
Setup Prompt Timeout			1		65535(0xFFFF)means indefinite waiting.
Bootup Numlock State			[On]		
Quiet Boot			[Disabled]		
Fast Boot			[Enabled]		
Boot Option Priorities					→←: Select Screen
Boot Option #1			[UEFI:Built-in EFI...]		↑↓ : Select Item
					Enter: Select
					+/- : Change Opt.
					F1 : General Help
					F2: Previous Values
					F3:Optimized Defaults
					F4:Save and Exit
					ESC Exit
Version 2.17.1246. Copyright (C) 2014 American Megatrends , Inc.					

Setup Prompt Timeout	[1]
Bootup Numlock State	[On]
Quiet Boot	[off]
Fast Boot	[Enabled]
Quiet Boot	[Disabled]

	[Enabled]
Fast Boot	
	[Disabled]
	[Enabled]
Boot Option Priorities	
Boot Option #1	
	Sets the system boot order
Hard Drive BBS Priorities	[SATA PM:*** ... ]
	Boot Option #1
	SATA PM:***...
	*****
	Disabled

### 3.8 Save & Exit Settings

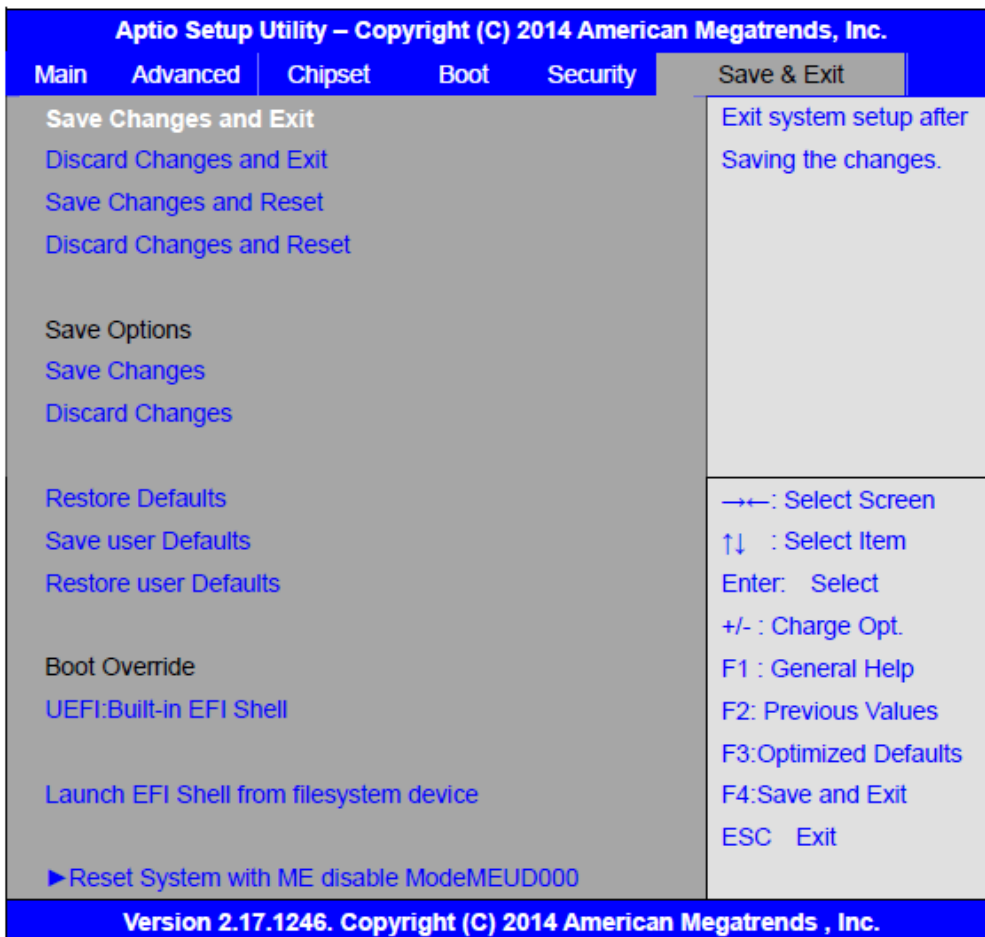

Save Changes and Exit

Save & Exit Setup save Configuration and exit ?

[Yes]

[No]

Discard Changes and Ext  
Exit Without Saving Quit without saving?  
[Yes]  
[No]

Save Changes and Reset  
Save & reset Save Configuration and reset?  
[Yes]  
[No]

Discard Changes and Reset  
Reset Without Saving Reset without saving?  
[Yes]  
[No]

Save Changes  
Save Setup Values Save configuration?  
[Yes]  
[No]

Discard Changes  
Load Previous Values Load Previous Values?  
[Yes]  
[No]

Restore Defaults  
Load Optimized Defaults Load optimized Defaults?  
[Yes]  
[No]

Save user Defaults  
Save Values as User Defaults Save configuration?  
[Yes]  
[No]

Restore user Defaults  
Restore User Defaults Restore User Defaults?  
[Yes]  
[No]

Launch EFI Shell from filesystem device  
WARNING Not Found  
[ok]

Reset System with ME disable ModeMEUD000  
ME will runs into the temporary disable mode, Ignore if ME Ignition  
FWMEUD001.

# Chapter 4 Installation of Drivers

This chapter describes the installation procedures for software and drivers under the windows 7. The software and drivers are included with the motherboard. The contents include **Intel chipset driver, VGA driver, LAN drivers, Audio driver, USB 3.0 driver, and Com driver** Installation instructions are given below.

**Important Note:**

After installing your Windows operating system, you must install first the Intel Chipset Software Installation Utility before proceeding with the installation of drivers.



## 4.1 Intel(R) Atom™ SoC Chipset

To install the Intel chipset driver, please follow the steps below.

**Step 1.** Select **Intel (R) Atom™ SoC Chipset** from the list



**Step 2.** Click **Next** to setup program.



**Step 3.** Read the license agreement. Click **Yes** to accept all of the terms of the license agreement.



**Step 4.** Click **Next** to continue.

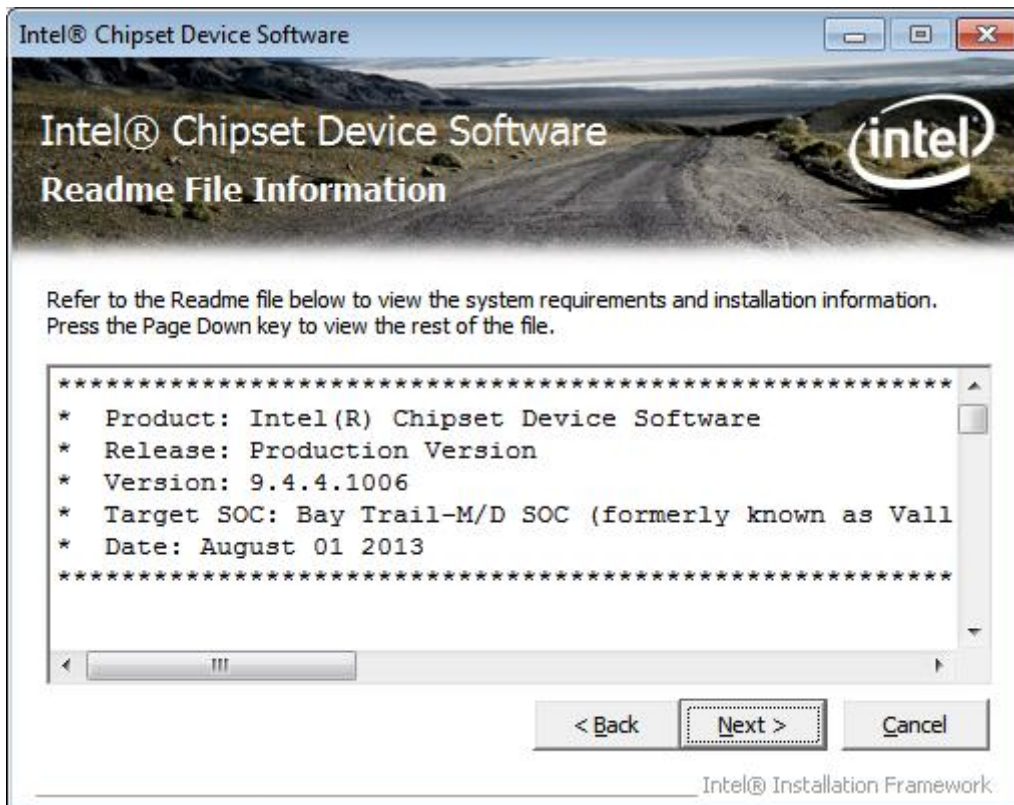

**Step 5. Click Next.**

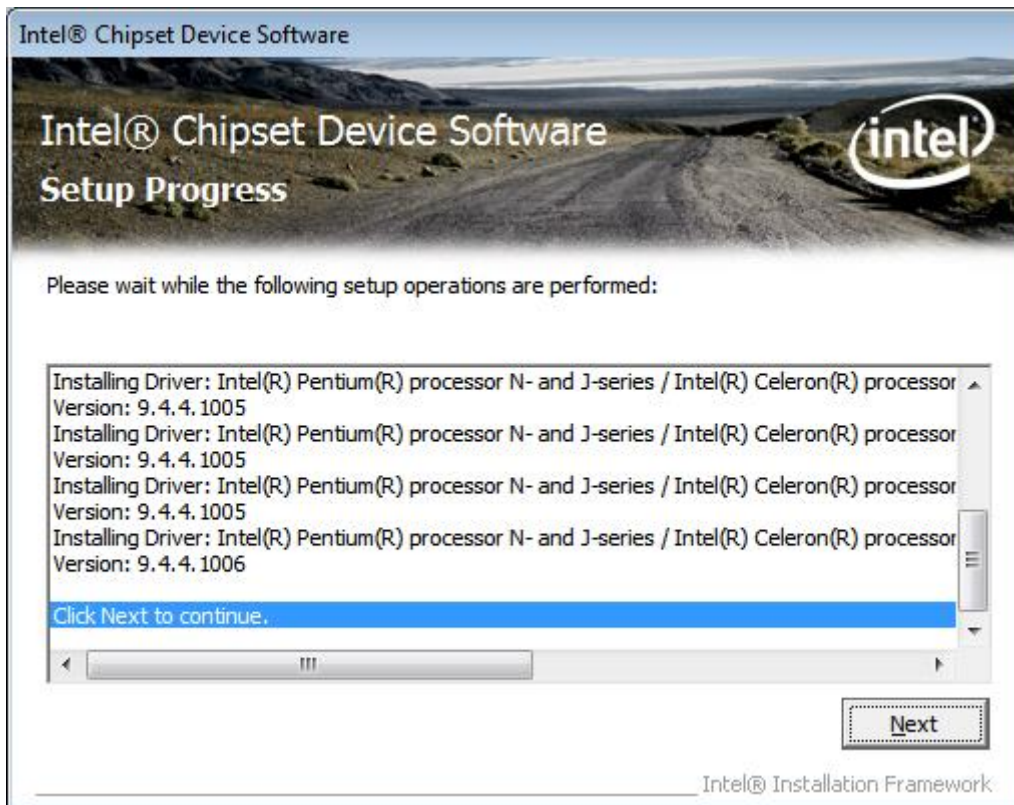

**Step 6. Select Yes, I want to restart this computer now.** Click **Finish**, then remove any installation media from the drives.



## 4.2 Intel(R) VGA Chipset

To install the VGA drivers, follow the steps below to proceed with the installation.

### Step 1. Select Intel(R) VGA Chipset



Step 2. Click **Automatically run WinSAT and enable the Windows Aero desktop theme(if supported).** Click **Next.**

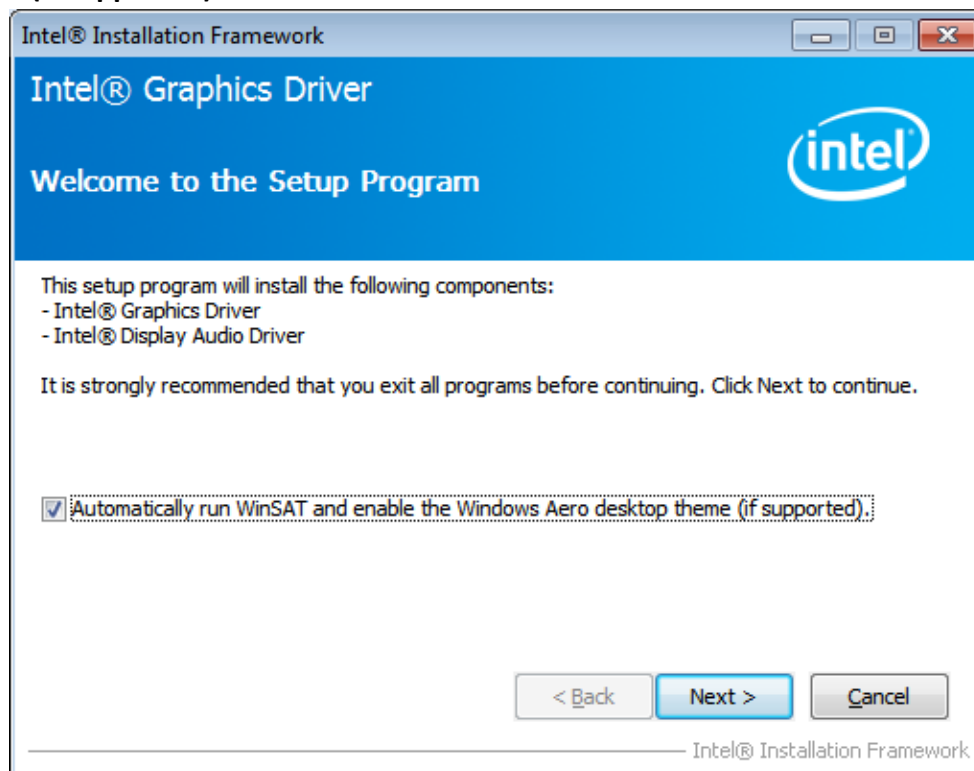



**Step 3.** Read license agreement. Click **Yes**.

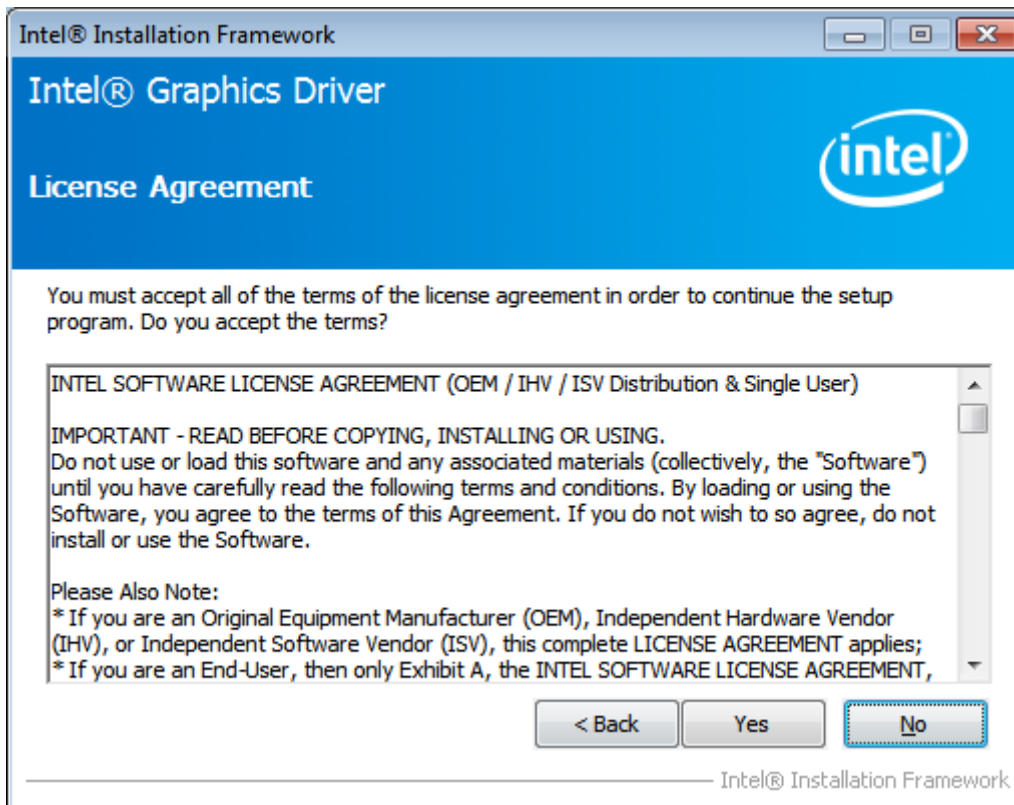

**Step 4.** Click **Next**.

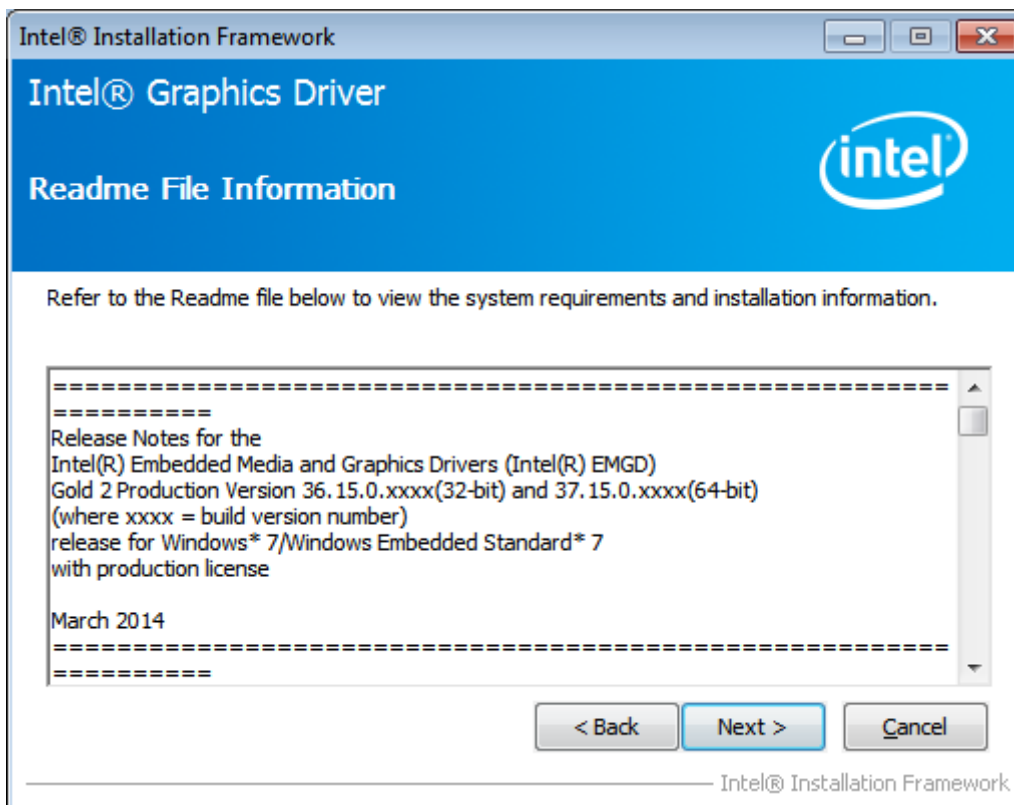

**Step 5. Click Install.**

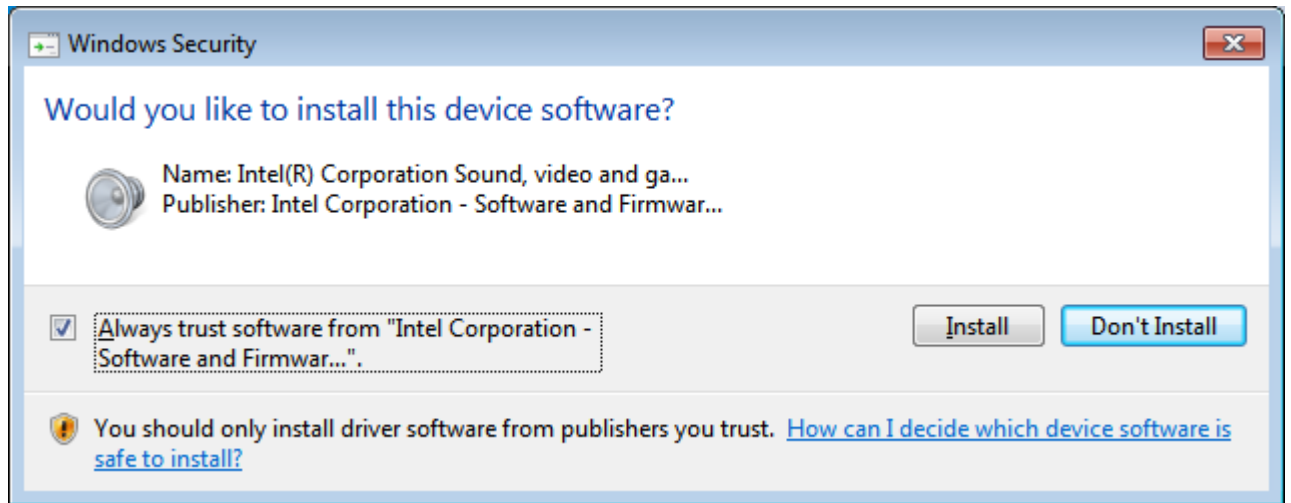

**Step 6. Click Install.**

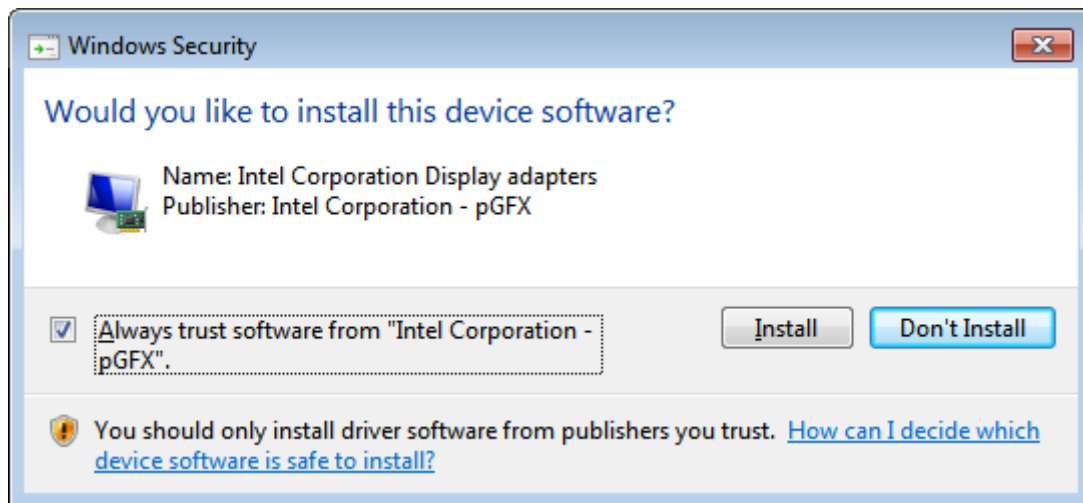

**Step 7. Click Next.**

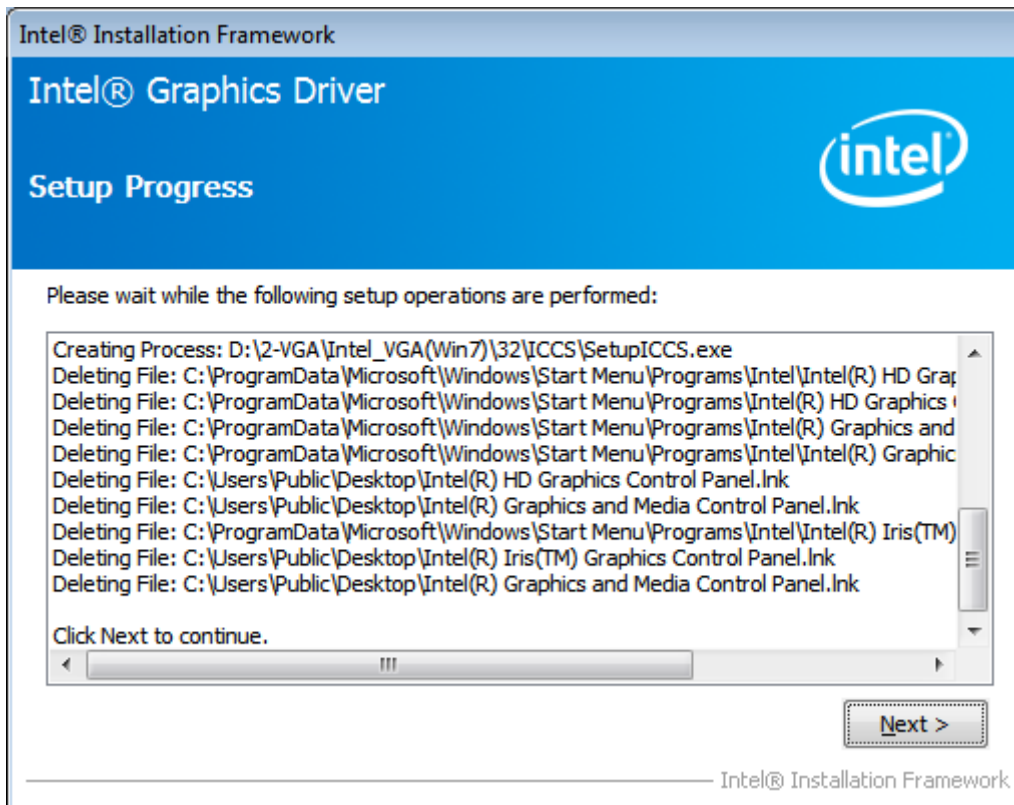

**Step 8. Click Yes, I want to restart this computer now. Then click Finish.**

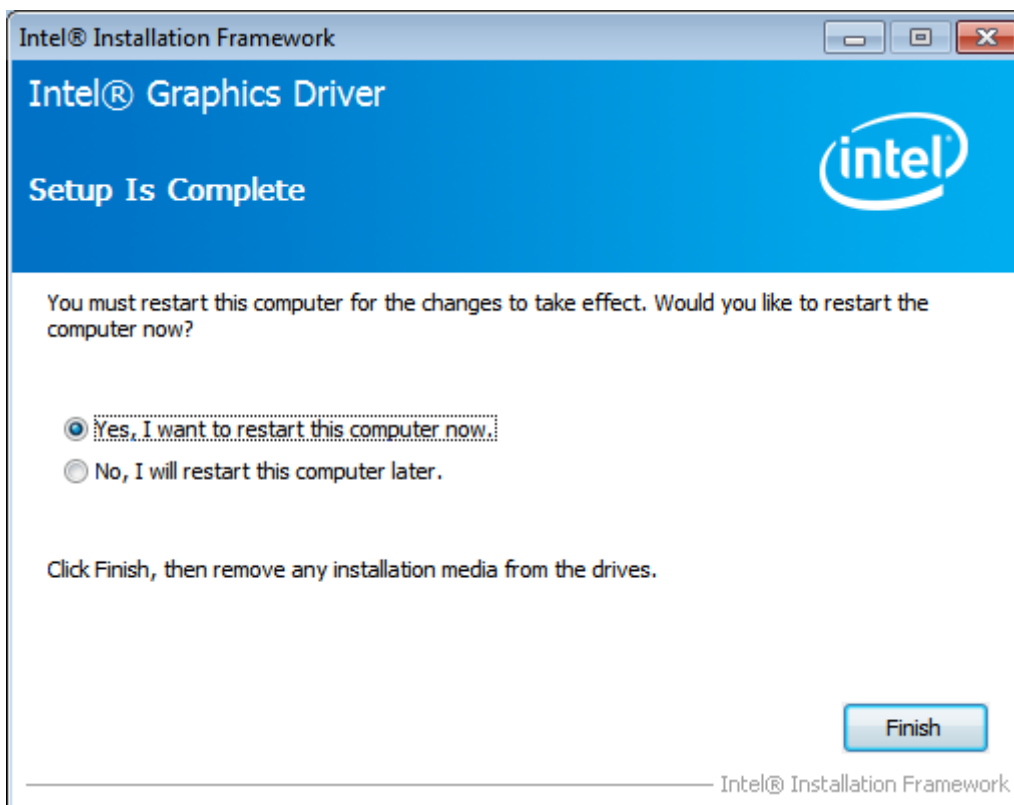

### 4.3 Intel(R) LAN Driver

To install the Intel (R) LAN driver, please follow the steps below.

**Step 1.** Select **Intel(R) 82574L LAN Driver** from the list.



**Step 2.** . Click **Next**.

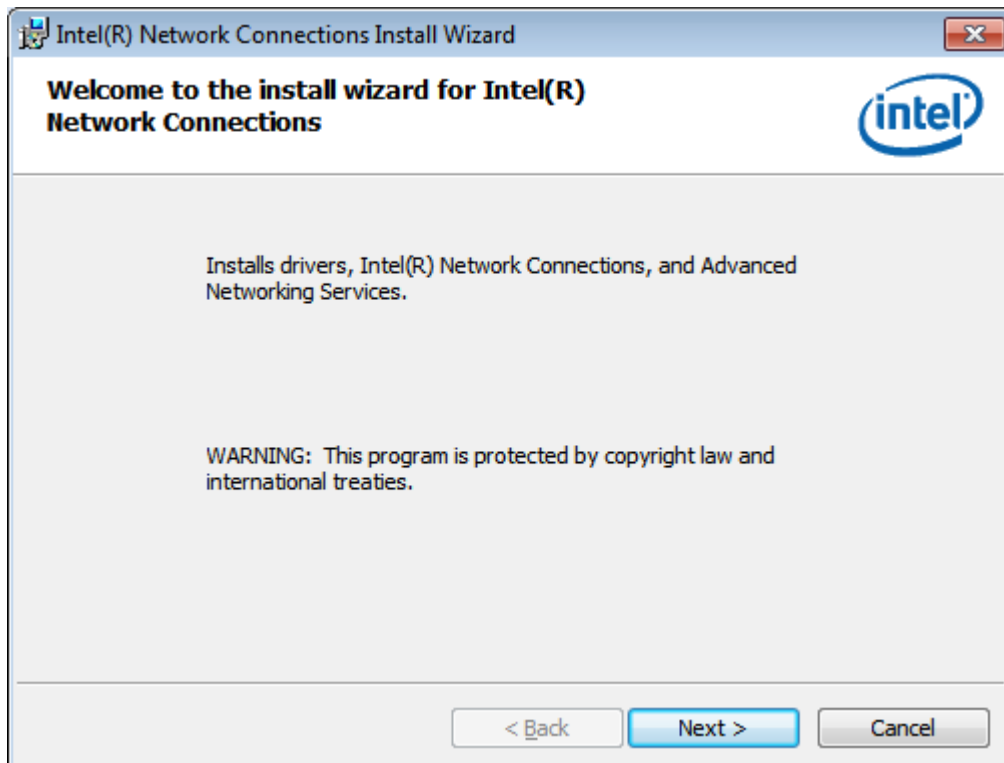

**Step 3.** Read license agreement. Click **I accept the terms in the license agreement.**  
Click **Next.**

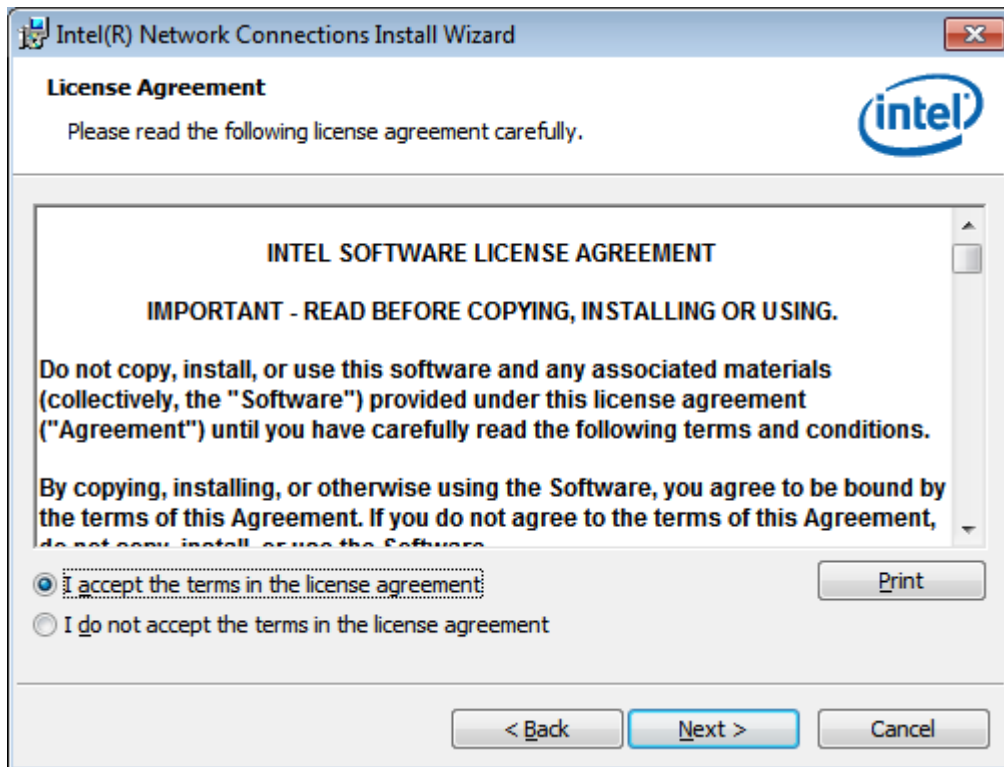

**Step 4.** Click **Next** to continue.

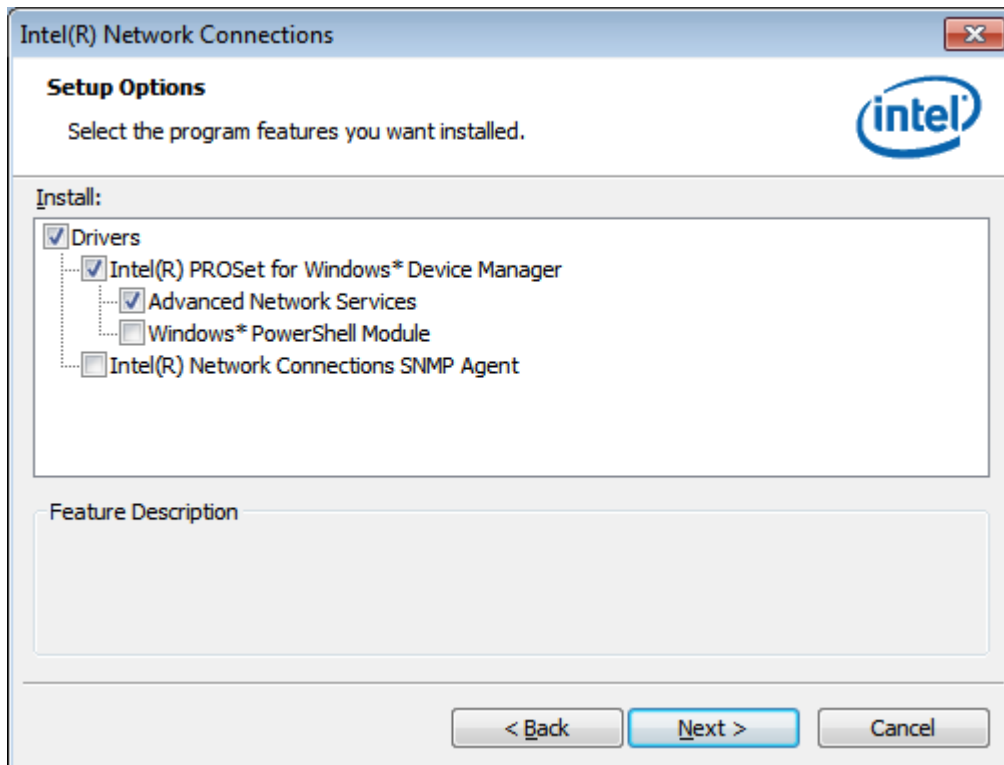

**Step 5.** Click **Install** to begin the installation.

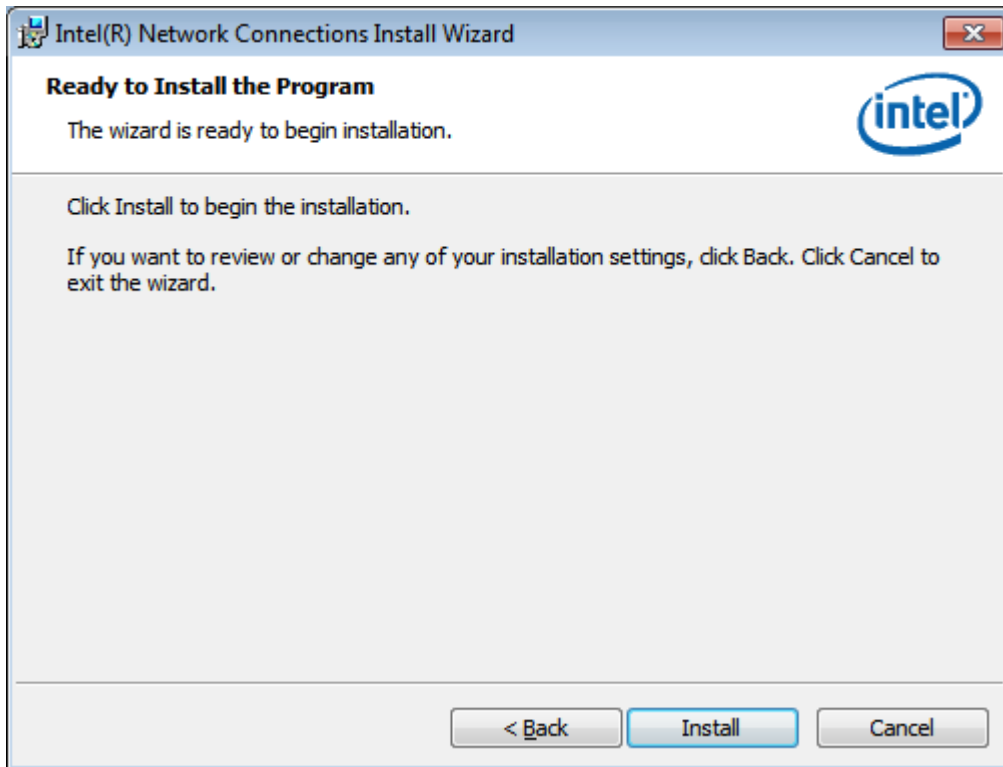

**Step 6.** Click **Finish** to exit the wizard.

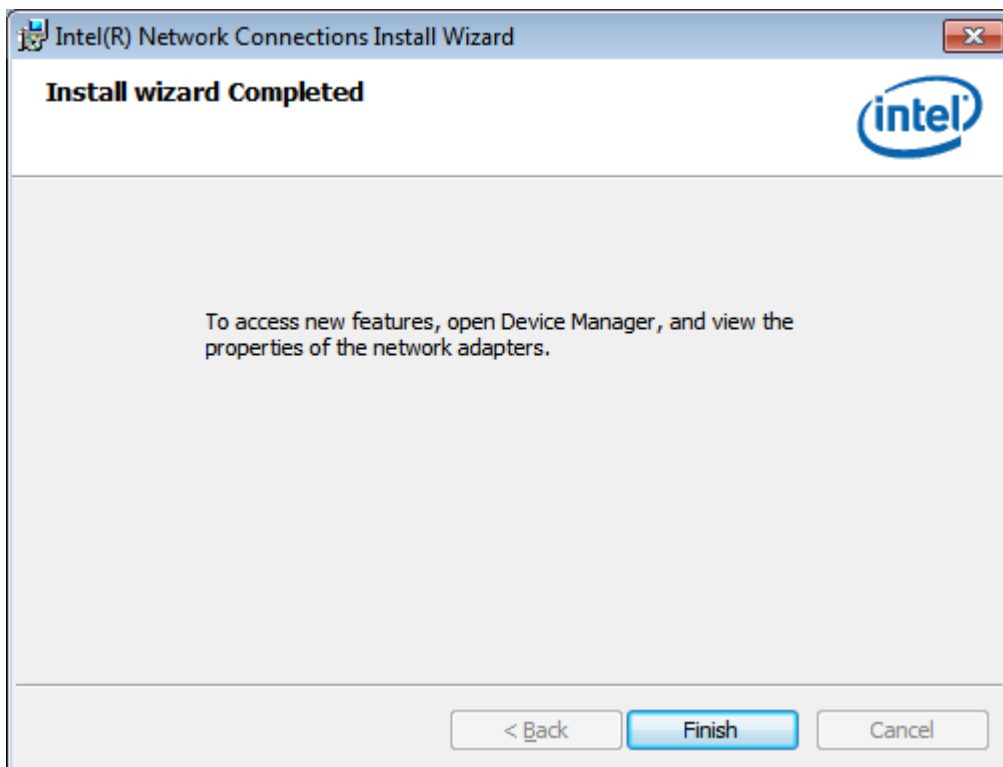

## 4.4 Realtek ALC662 HD Audio Driver Installation

To install the Realtek ALC662 HD Audio Driver, please follow the steps below.

**Step 1.** Select Realtek AL662 HD Audio Driver from the list



**Step 2.** Click Next to continue.

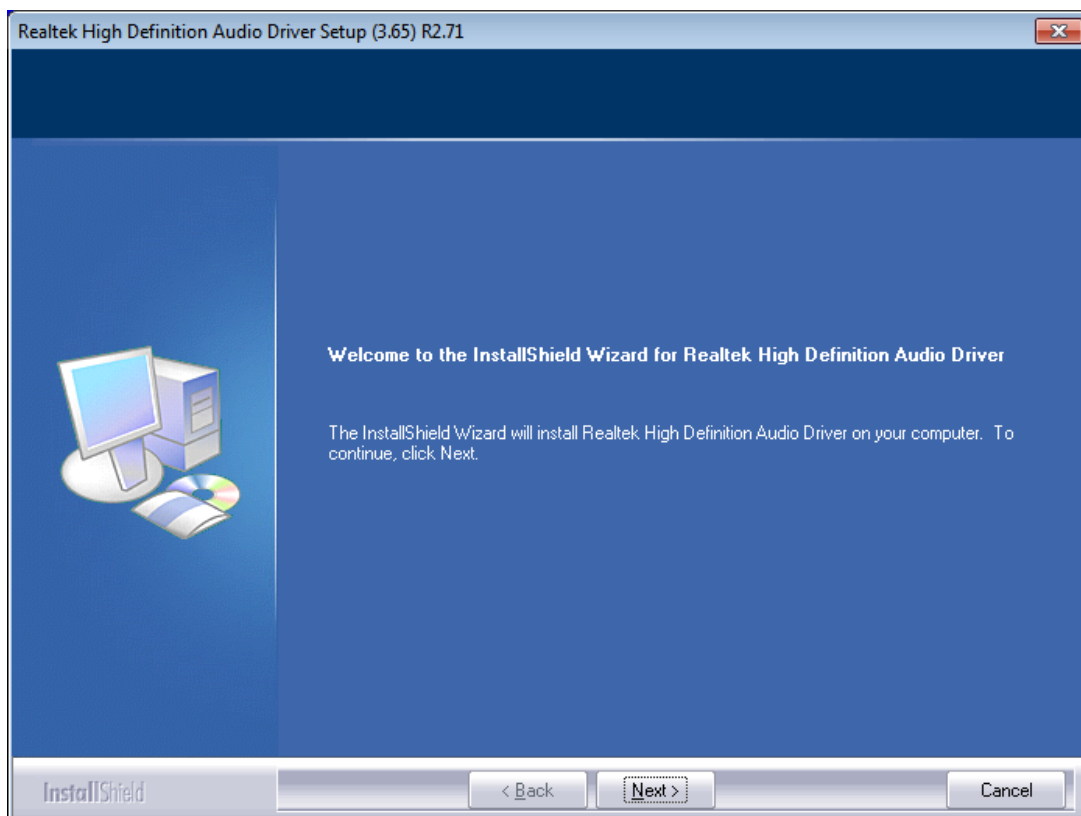

**Step 3.** Click **Yes, I want to restart my computer now.** Click **Finish** to complete the installation.

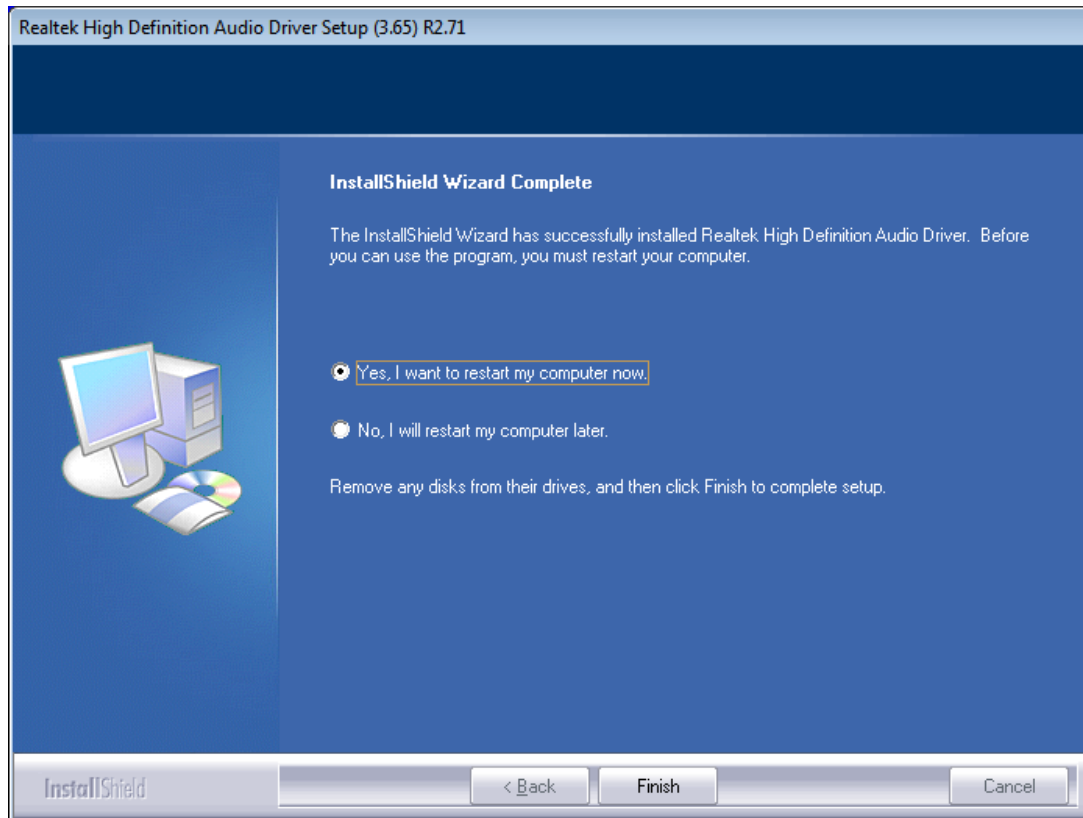

## 4.5 USB 3.0 Driver

To install the USB 3.0 Driver, please follow the steps below.

**Step 1.** Select **USB 3.0 Driver** from the list





**Step 2.** Click **Next** to continue.



**Step 3.** Read the license agreement. Then click **Yes** to continue.

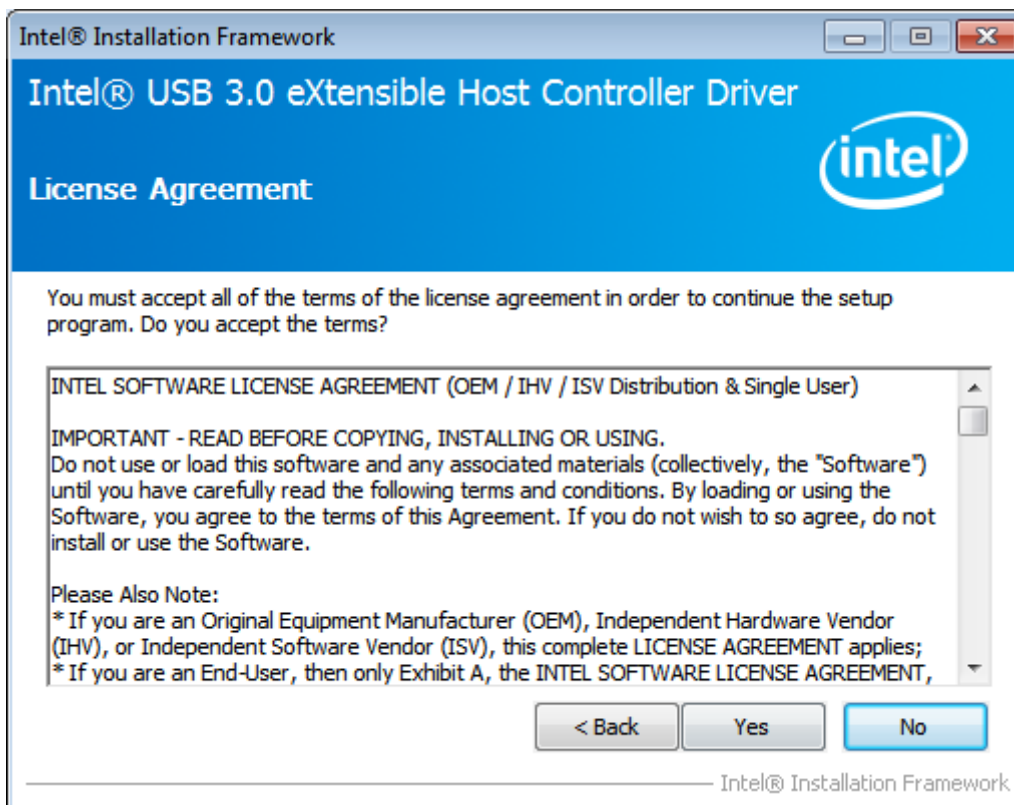

**Step 4.** Click **Next** to continue.

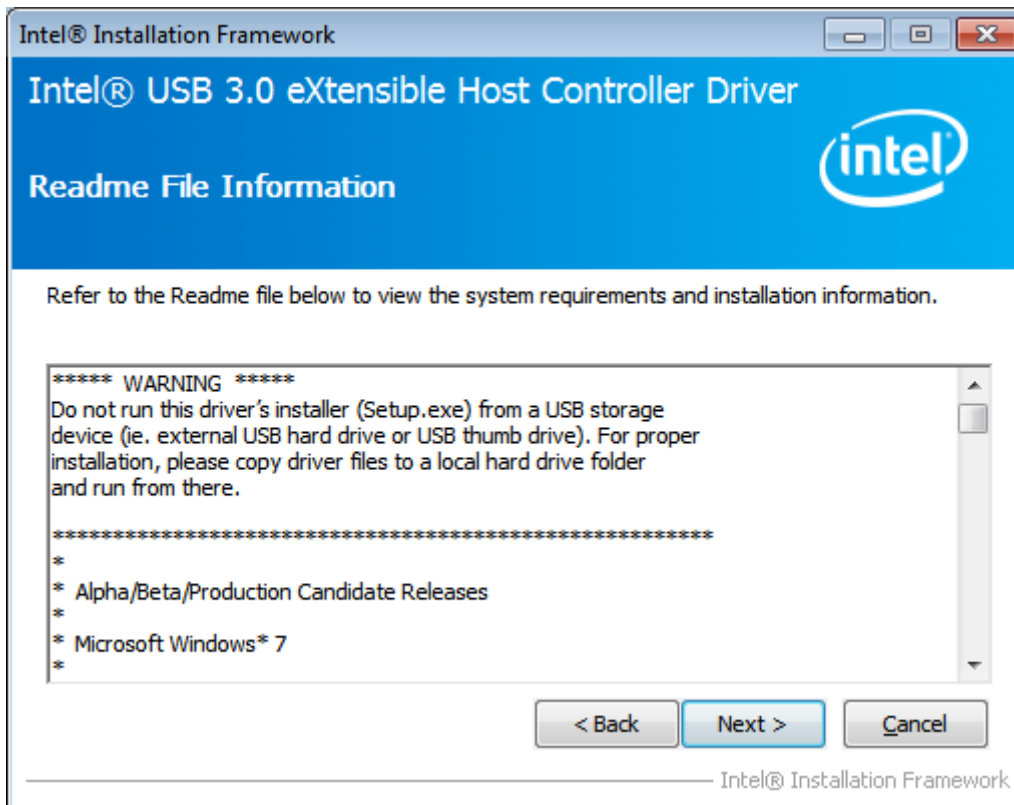

**Step 5.** Click **Next** to continue.

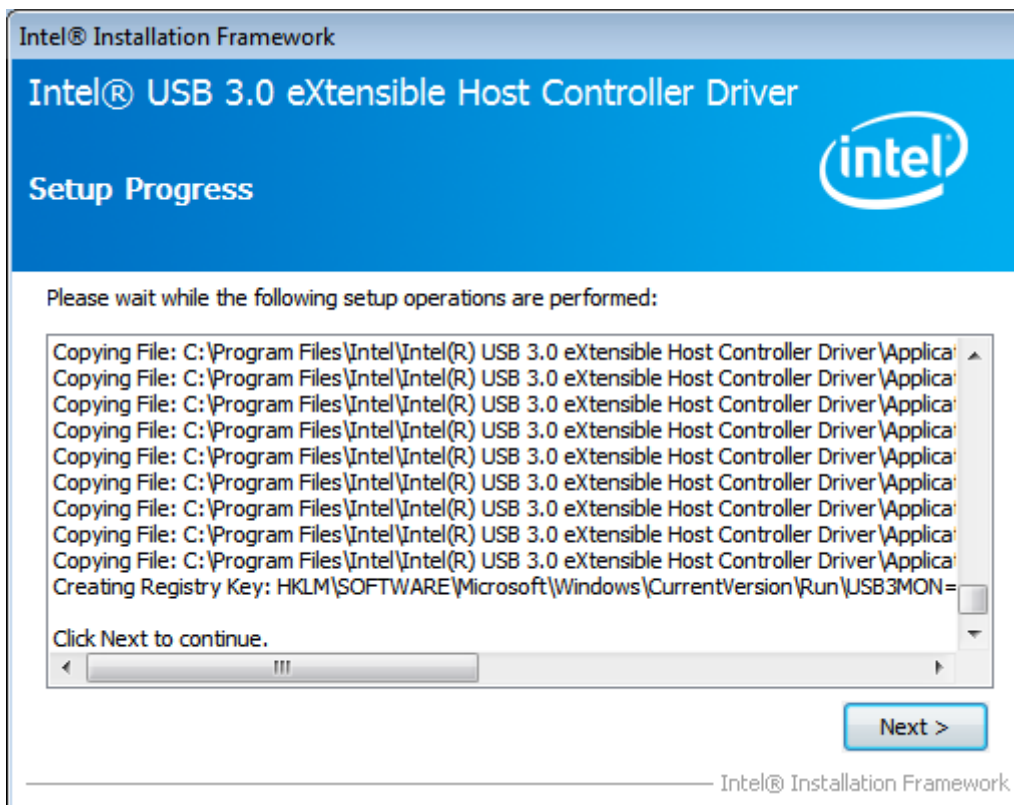

**Step 6.** Select **Yes, I want to restart this computer now.** Then click **Finish** to complete the installation.

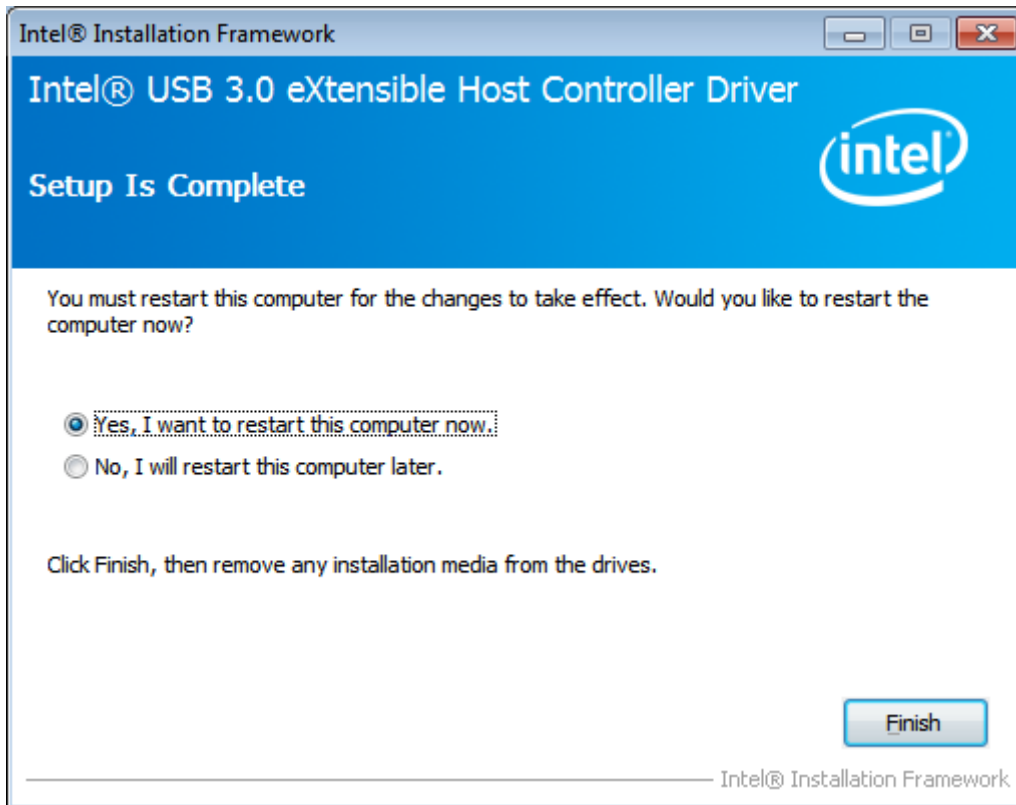

## 4.6 Com Driver

To install the Com Driver, please follow the steps below.

**Step 1.** Select **Com Driver** from the list



**Step 2.** Click **Next** to continue.

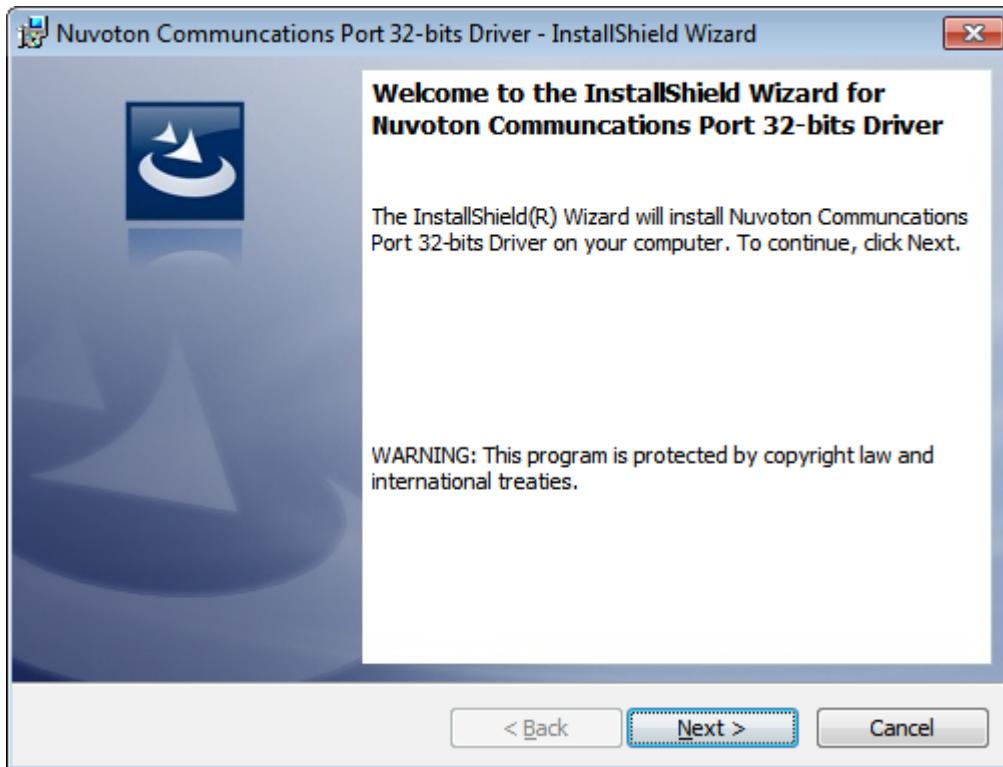

**Step 3.** Click **install** to begin the installation.

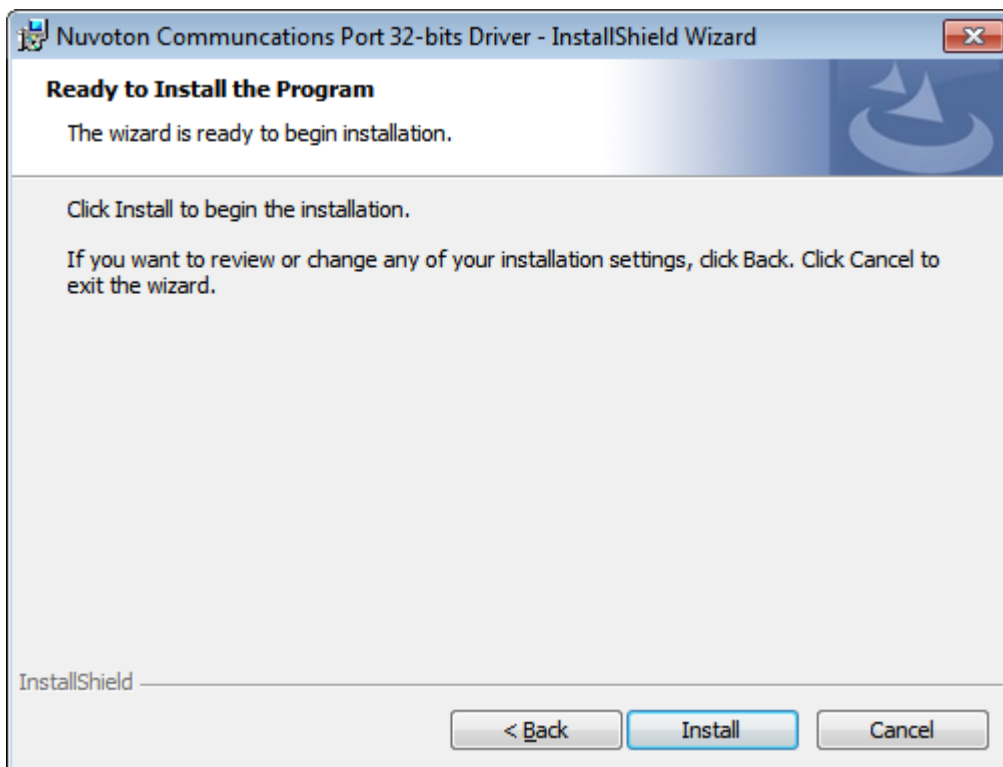

**Step 4.** Click **Finish** to complete the installation.

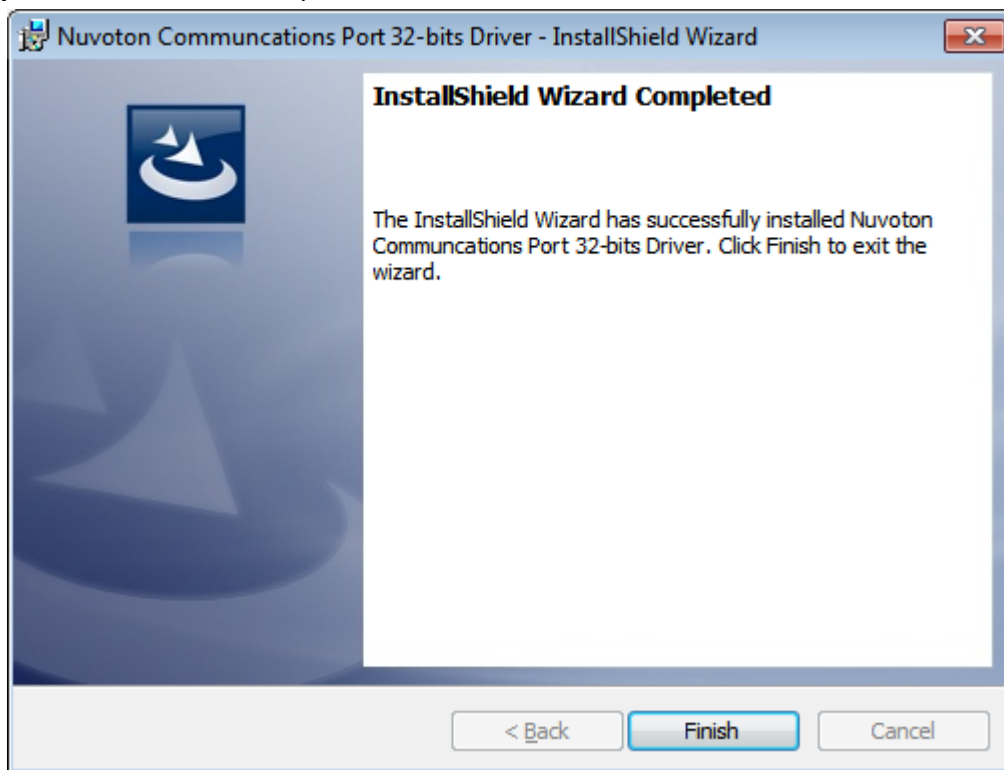

# Chapter 5 Touch Screen Installation

This chapter describes how to install drivers and other software that will allow your touch screen work with different operating systems.

## 5.1 Windows 7/8.1 Universal Driver Installation for PenMount 6000 Series

Before installing the Windows 7/8.1 driver software, you must have the Windows 7/8.1 system installed and running on your computer. You must also have one of the following PenMount 6000 series controller or control boards installed: PM6500, PM6300.

### 5.1.1 Installing Software(Resistive Touch)

If you have an older version of the PenMount Windows 7 driver installed in your system, please remove it first. Follow the steps below to install the PenMount DMC6000 Windows 7 driver.

**Step 1.** Insert the product CD, the screen below would appear. Click **Touch Panel Driver**.



**Step 2.** Click **Next** to continue.

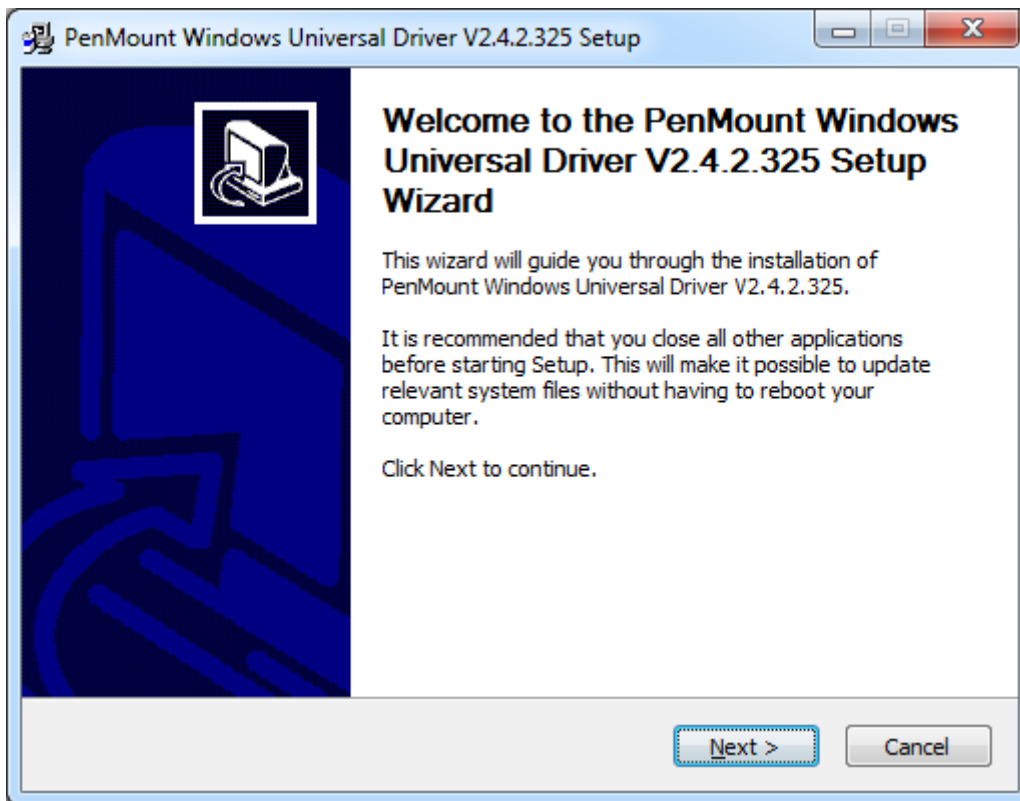

**Step 3.** Read the license agreement. Click **I Agree** to agree the license agreement.

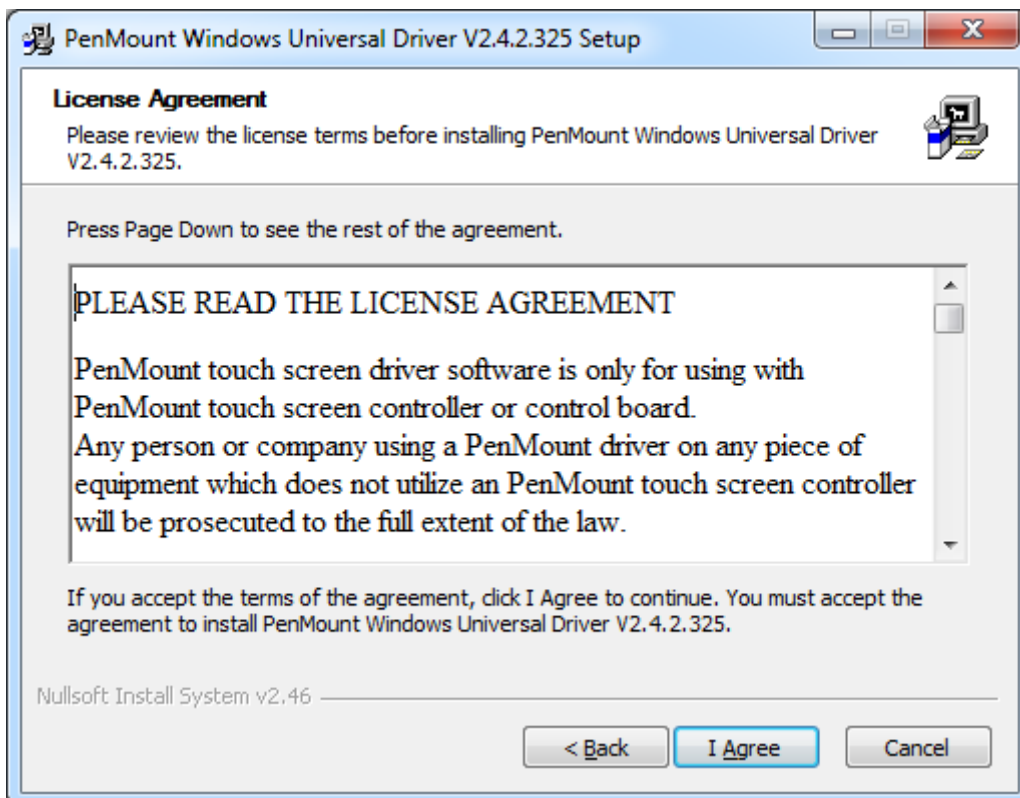

**Step 4.** Choose the folder in which to install PenMount Windows Universal Driver. Click **Install** to start the installation.

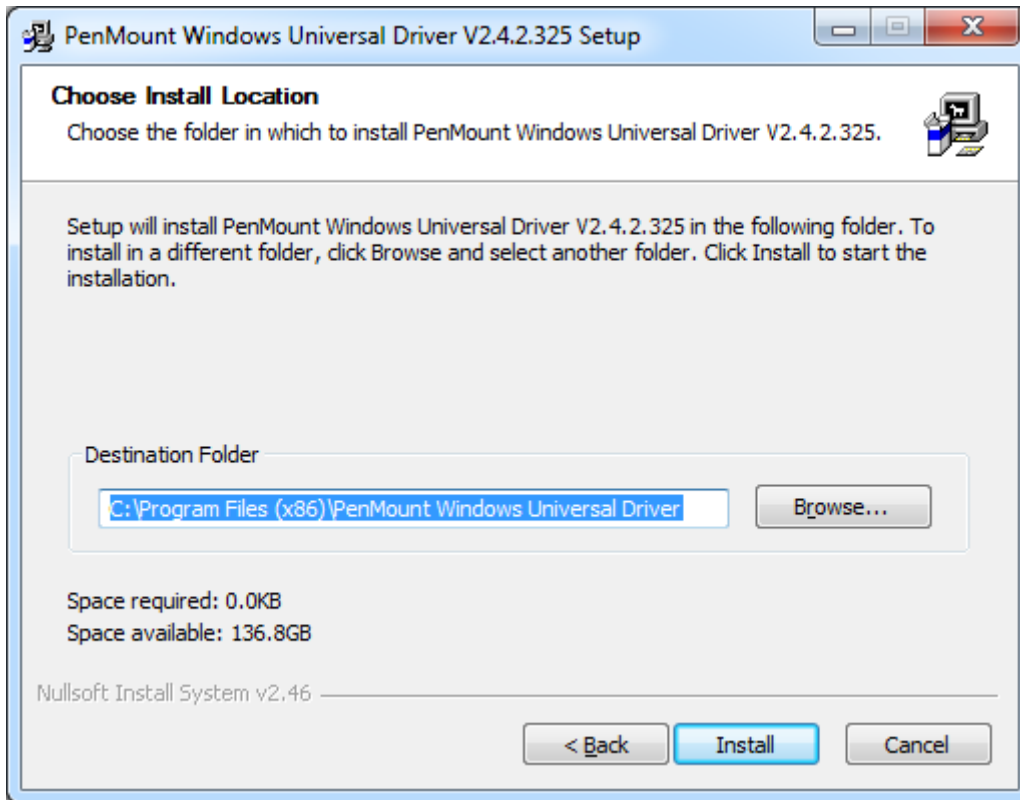

**Step 5.** Click **Yes** to continue.

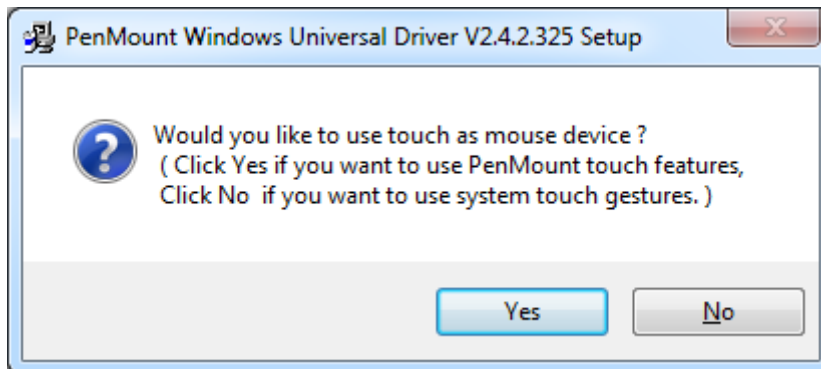



**Step 6.** Click **Finish** to complete installation.

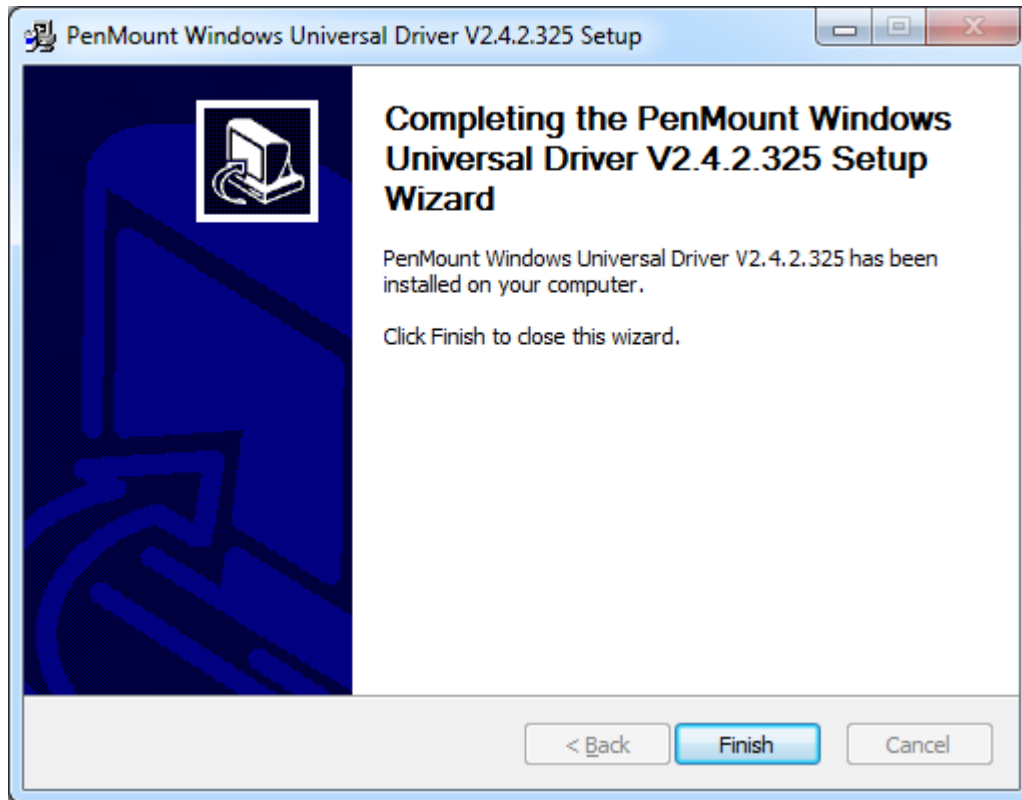

## 5.1.2 Installing Software (Projected Capacitive)

**Step 1.** Insert the product CD, the screen below would appear. Click touch panel driver.



**Step 2.** Click **Next** to continue.

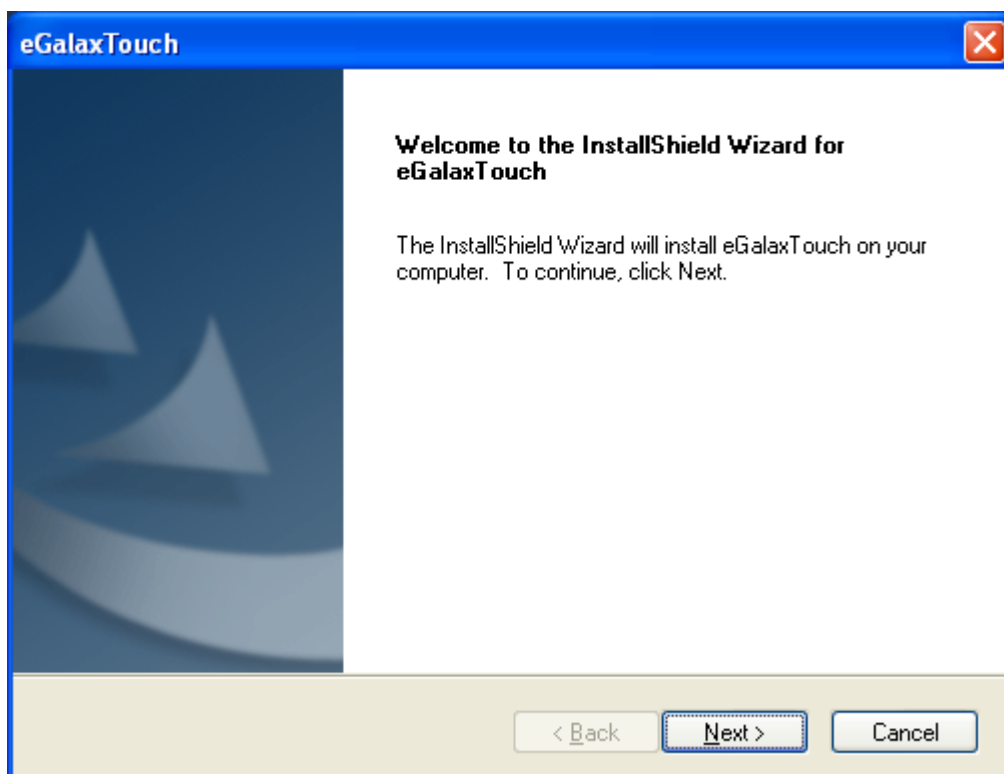

**Step 3.** Select **I accept the terms of the license agreement.** Click **Next.**

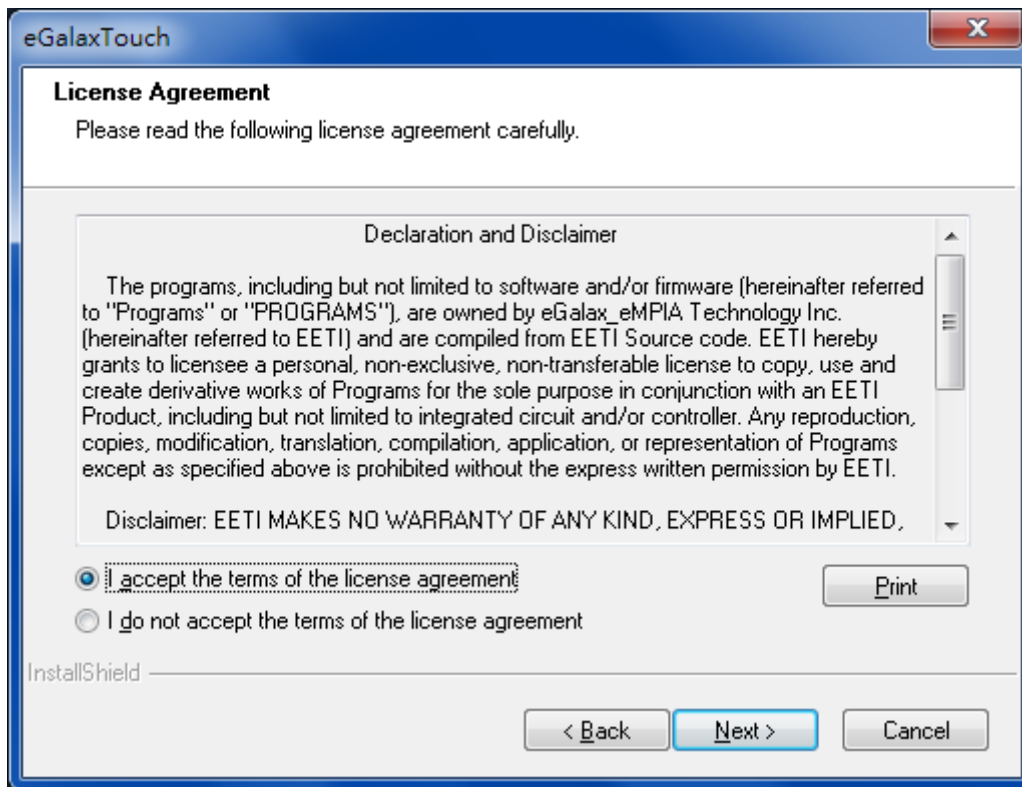

**Step.4.** Click **Next** to continue.

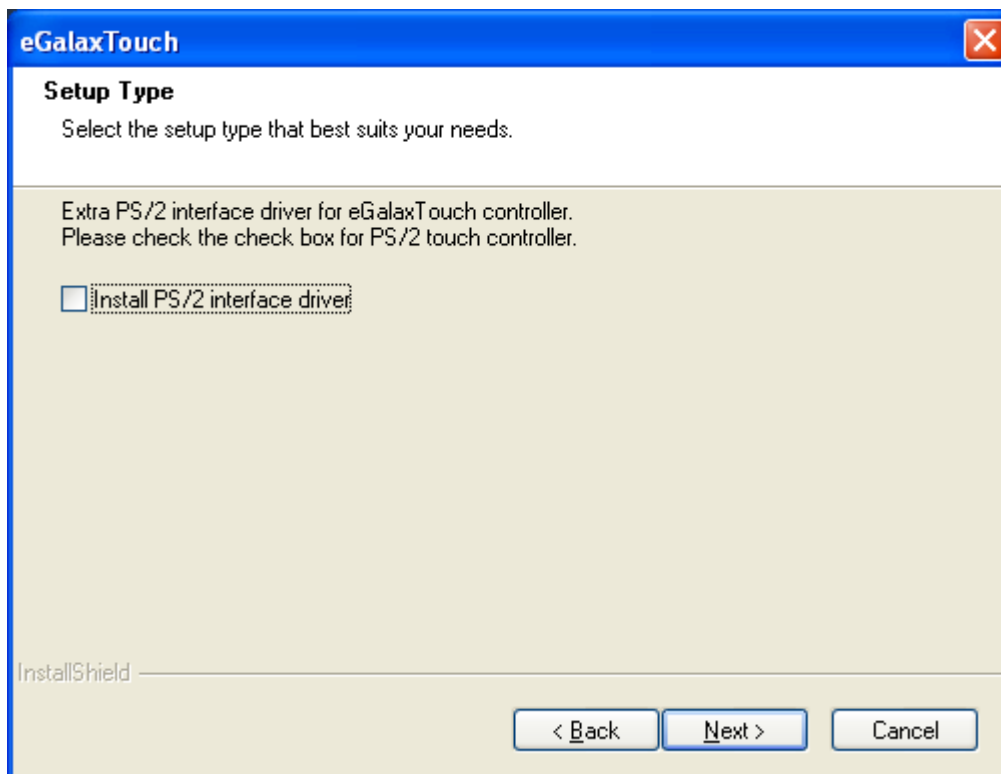

**Step 5. Click Install RS232 interface driver.**

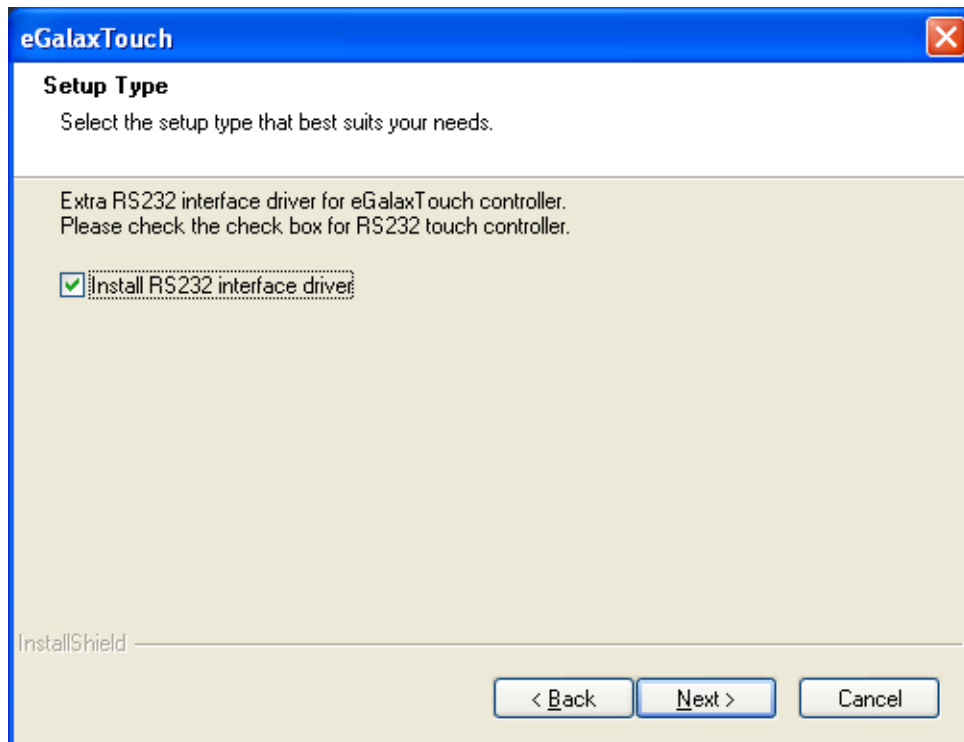

**Step 6. Select None. Click Next.**

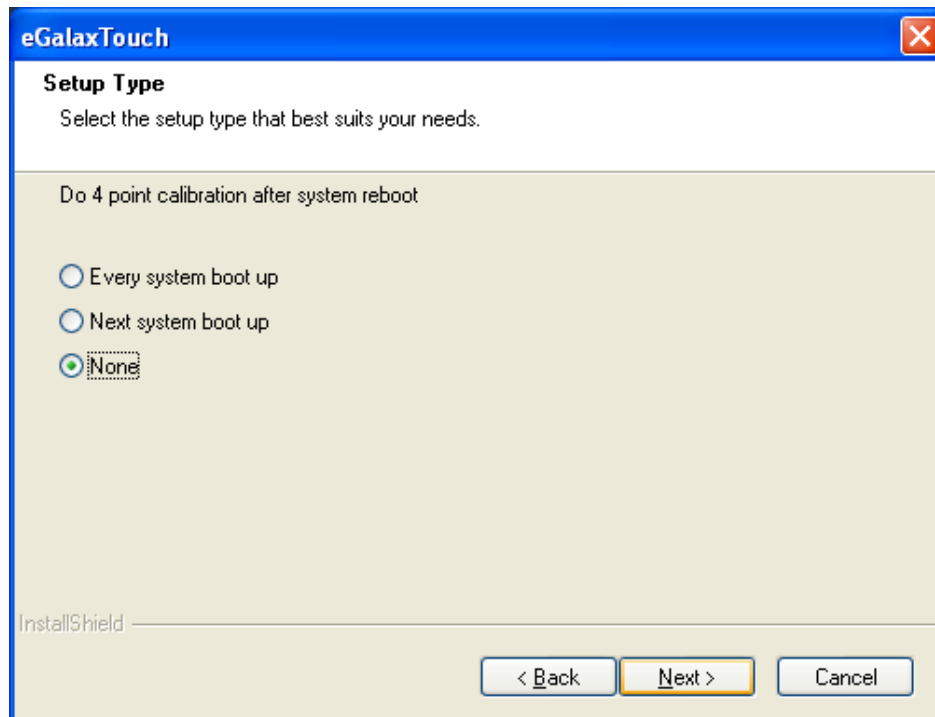

**Step 7. Click OK.**

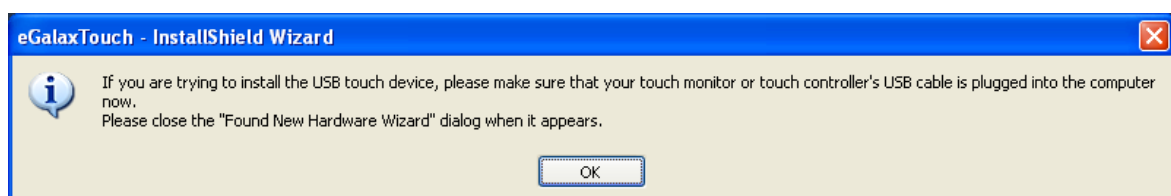

**Step 8.** Click **Support Multi-Monitor System**. Click **Next**.

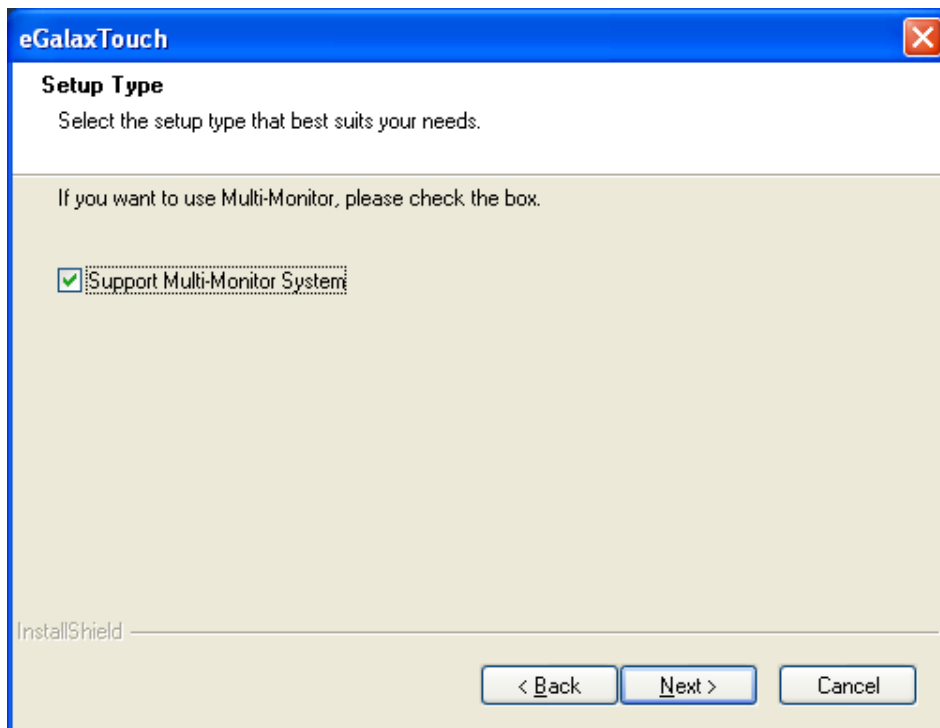

**Step 9.** Go to **C:\Program Files\eGalaxTouch**. Click **Next**.

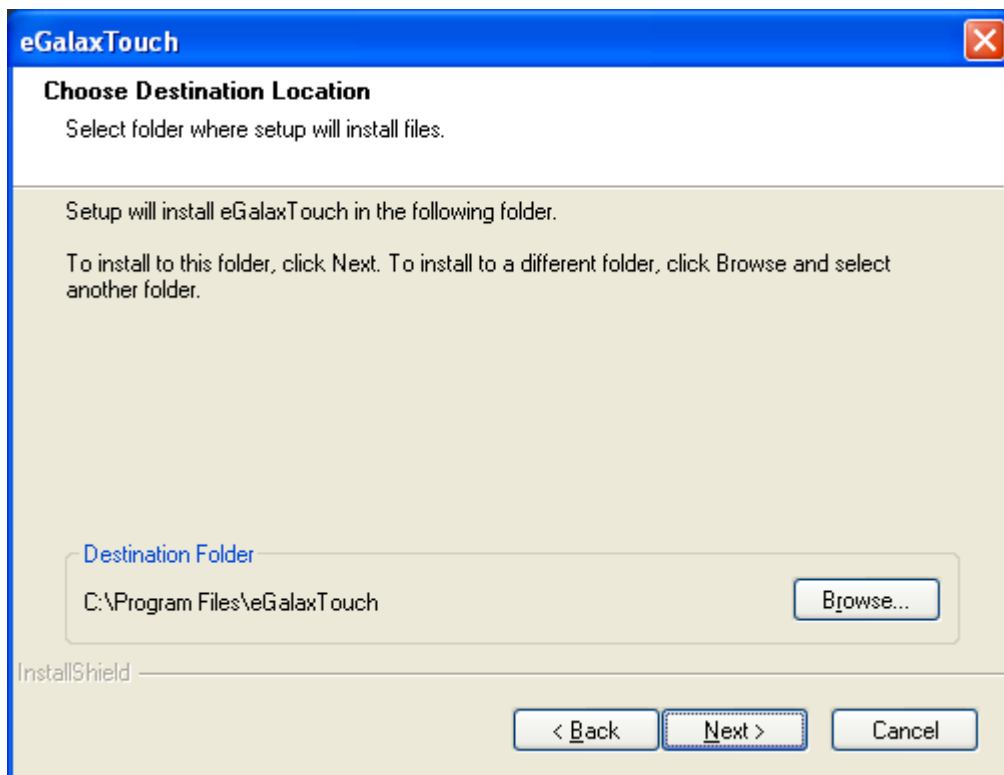

**Step 10. Click Next.**

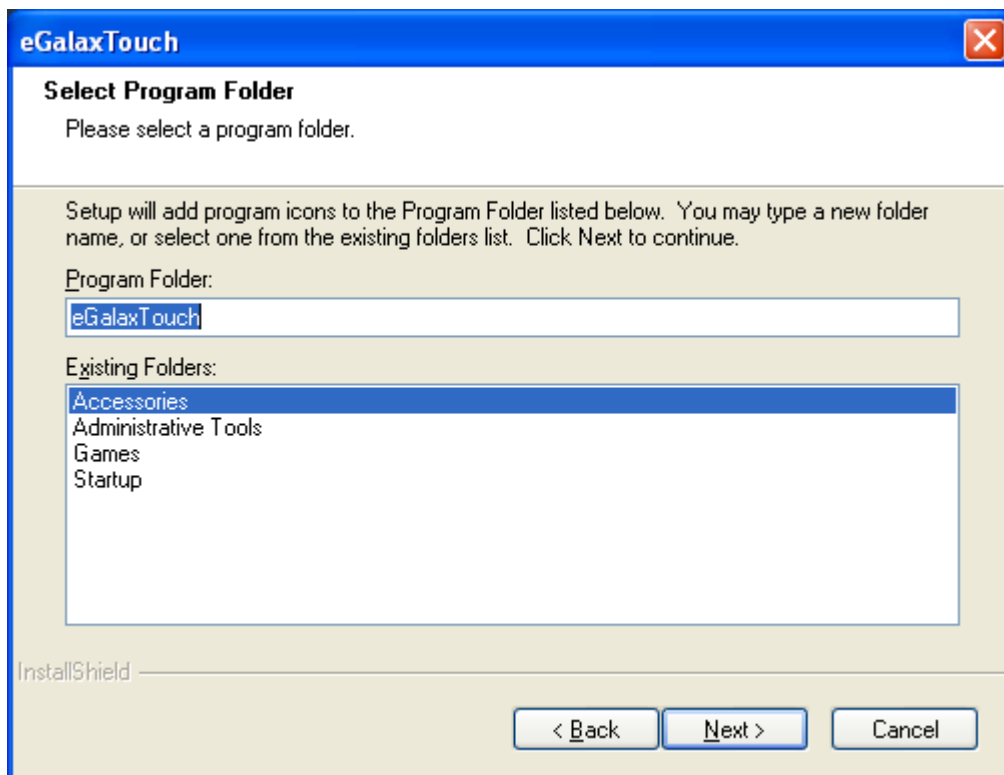

**Step 11. Click Create a eGalaxTouch Utility shortcut on desktop. Click Next.**

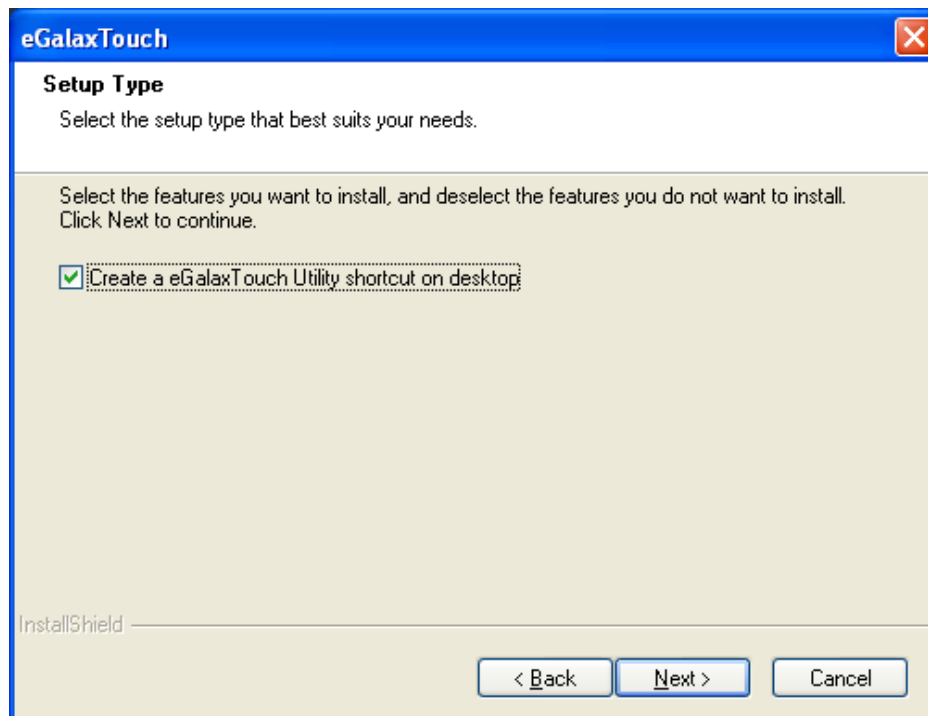

**Step 12.** Wait for installation.

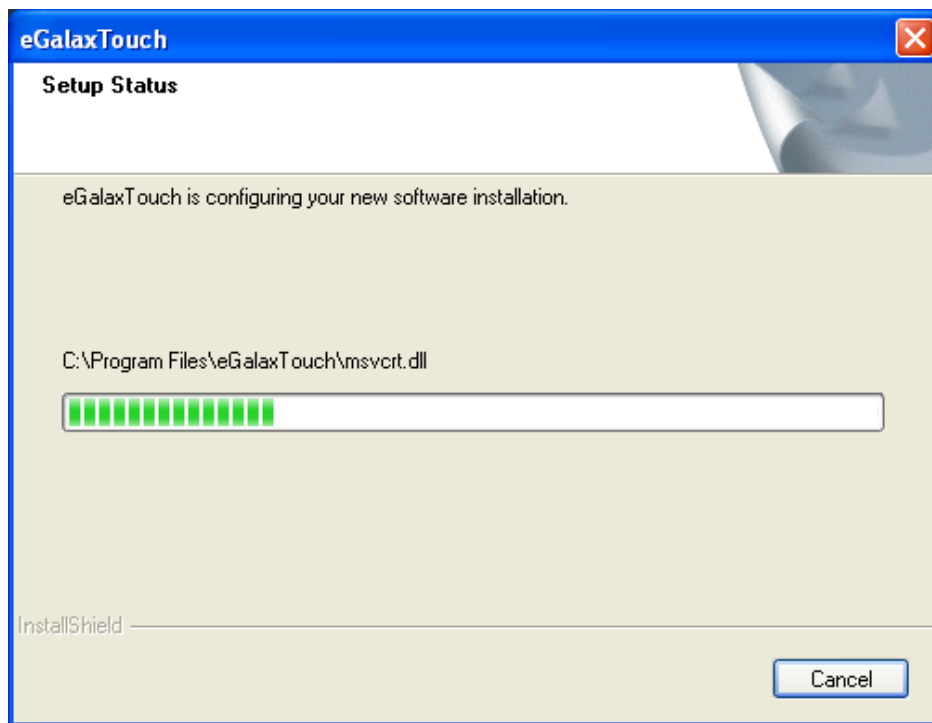

**Step 13.** Click **Yes** to do 4 point calibration.

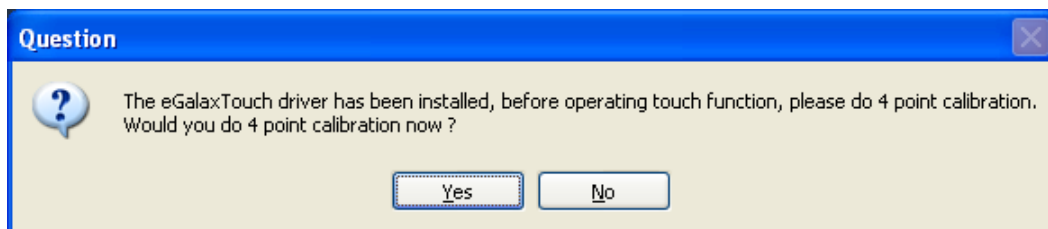

## 5.2 Software Functions

### 5.2.1 Software Functions(Resistive Touch)

Upon rebooting, the computer automatically finds the new 6000 controller board. The touch screen is connected but not calibrated. Follow the procedures below to carry out calibration.

1. After installation, click the PenMount Monitor icon “PM” in the menu bar.
2. When the PenMount Control Panel appears, select a device to “Calibrate.”

#### PenMount Control Panel(Resistive Touch)

The functions of the PenMount Control Panel are **Device**, **Multiple Monitors** ,**Tools** and **About**, which are explained in the following sections.

#### Device

In this window, you can find out that how many devices be detected on your system.

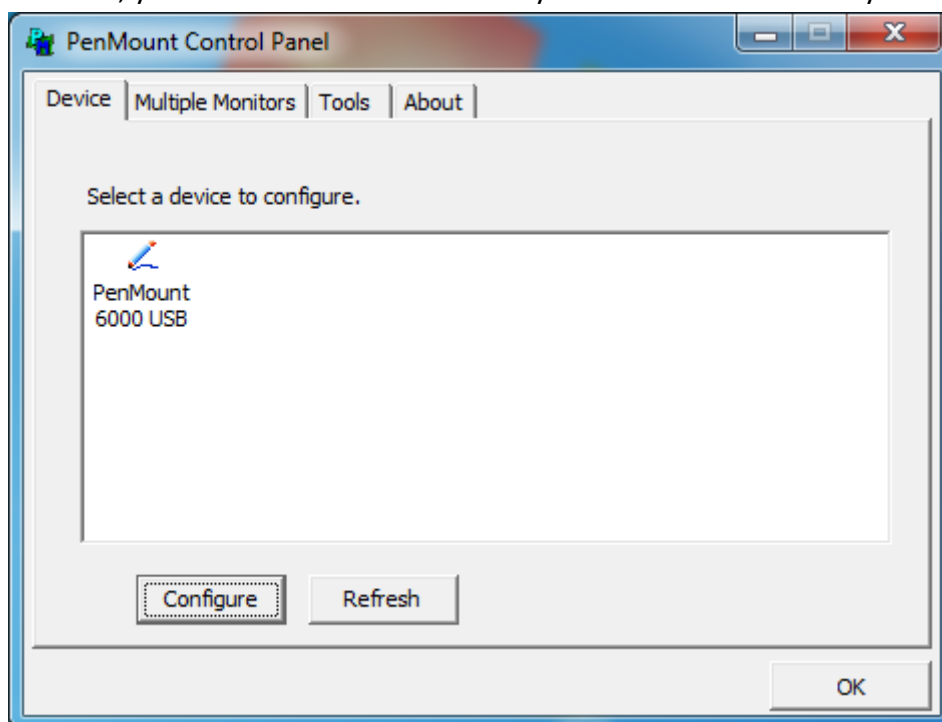

#### Calibrate

This function offers two ways to calibrate your touch screen. ‘Standard Calibration’ adjusts most touch screens. ‘Advanced Calibration’ adjusts aging touch screens.



Standard Calibration	<b>Click this button and arrows appear pointing to red squares. Use your finger or stylus to touch the red squares in sequence. After the fifth red point calibration is complete. To skip, press 'ESC'.</b>
Advanced Calibration	<b>Advanced Calibration uses 4, 9, 16 or 25 points to effectively calibrate touch panel linearity of aged touch screens. Click this button and touch the red squares in sequence with a stylus. To skip, press ESC'.</b>

**Step 1.** Please select a device then click “Configure”. You can also double click the device too.

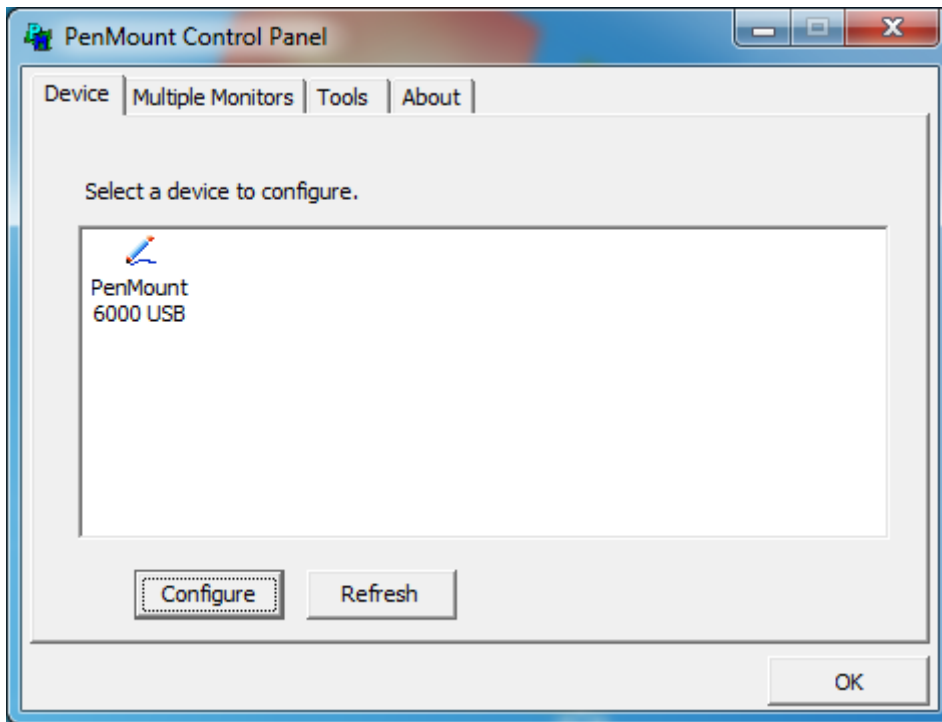

**Step 2.** Click “Standard Calibration” to start calibration procedure

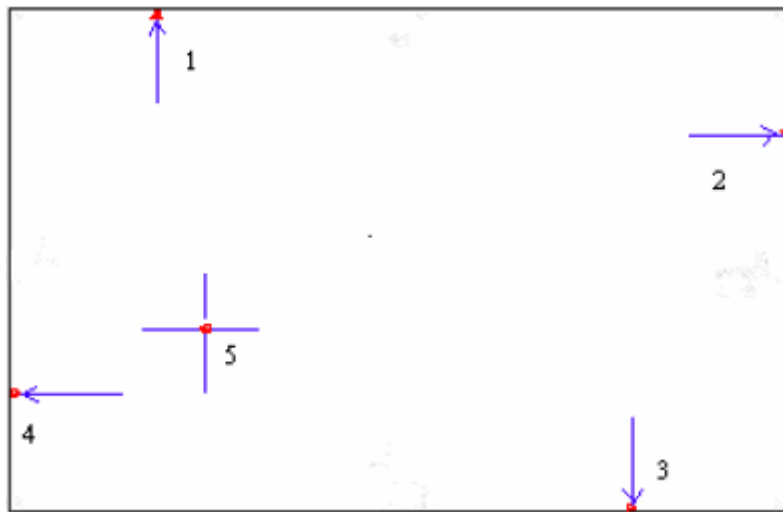
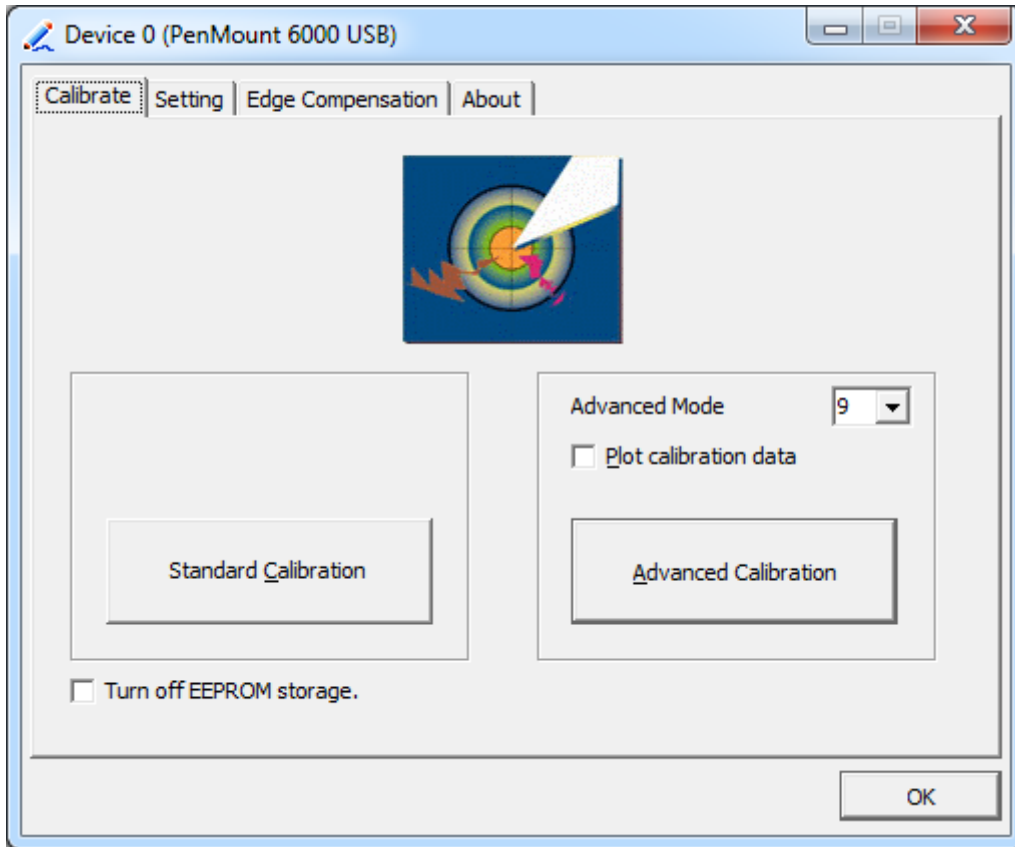

**NOTE:** The older the touch screen, the more Advanced Mode calibration points you need for an accurate calibration. Use a stylus during Advanced Calibration for greater accuracy. Please follow the step as below:

**Step 3.** Select **Device** to calibrate, then you can start to do **Advanced Calibration**.

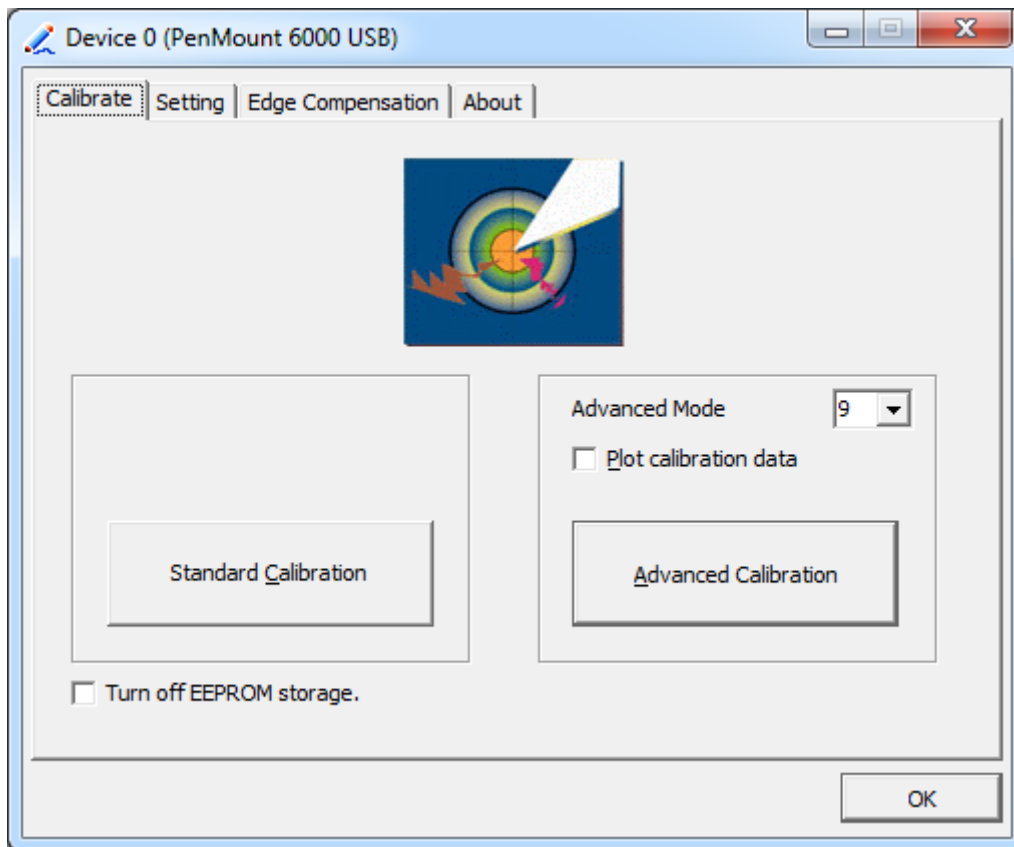

**NOTE:** Recommend to use a stylus during Advanced Calibration for greater accuracy.



Plot Calibration Data	<b>Check this function and a touch panel linearity comparison graph appears when you have finished Advanced Calibration. The blue lines show linearity before calibration and black lines show linearity after calibration.</b>
Turn off EEPROM storage	<b>The function disable for calibration data to write in Controller. The default setting is Enable.</b>

## Setting

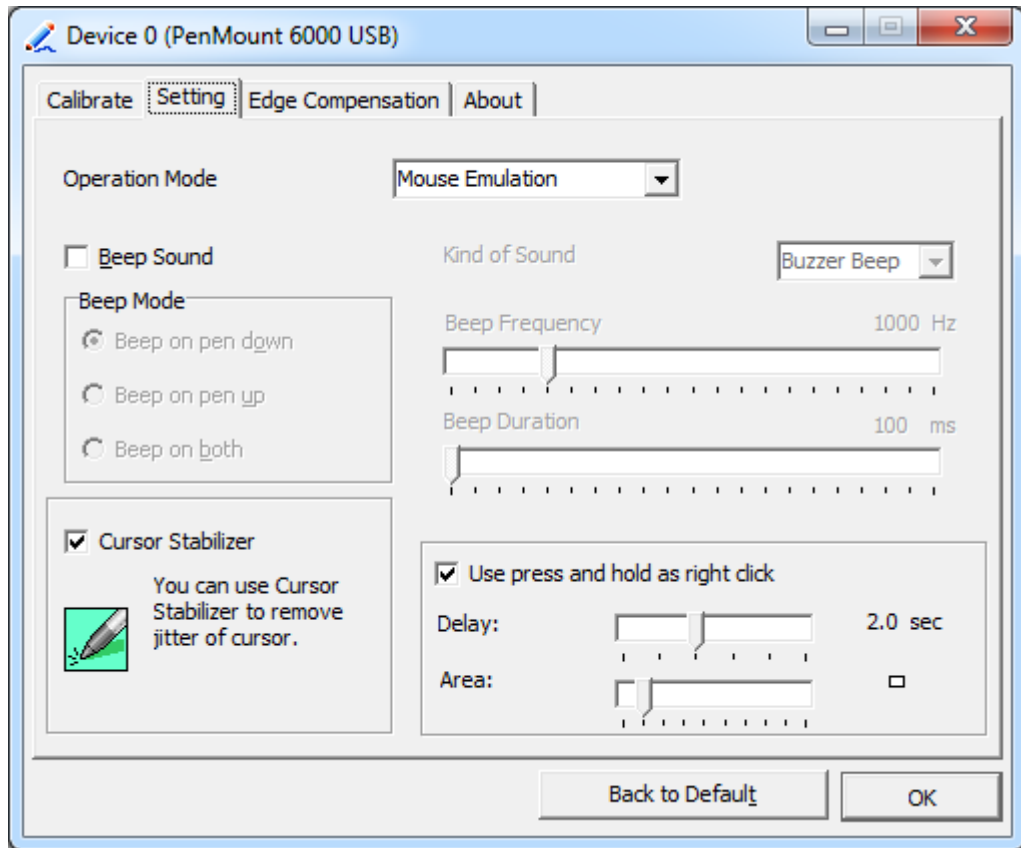

Touch Mode	<p><b>This mode enables and disables the mouse's ability to drag on-screen icons – useful for configuring POS terminals.</b></p> <p><b>Mouse Emulation – Select this mode and the mouse functions as normal and allows dragging of icons.</b></p> <p><b>Click on Touch – Select this mode and mouse only provides a click function, and dragging is disabled.</b></p>
Beep Sound	<p><b>Enable Beep Sound – turns beep function on and off</b></p> <p><b>Beep on Pen Down – beep occurs when pen comes down</b></p> <p><b>Beep on Pen Up – beep occurs when pen is lifted up</b></p> <p><b>Beep on both – beep occurs when comes down and lifted up</b></p> <p><b>Beep Frequency – modifies sound frequency</b></p> <p><b>Beep Duration – modifies sound duration</b></p>
Cursor Stabilizer	<p><b>Enable the function support to prevent cursor shake.</b></p>
Use press and hold as right click	<p><b>You can set the time out and area for you need.</b></p>

## Edge Compensation

You can use Edge Compensation to calibrate more subtly.

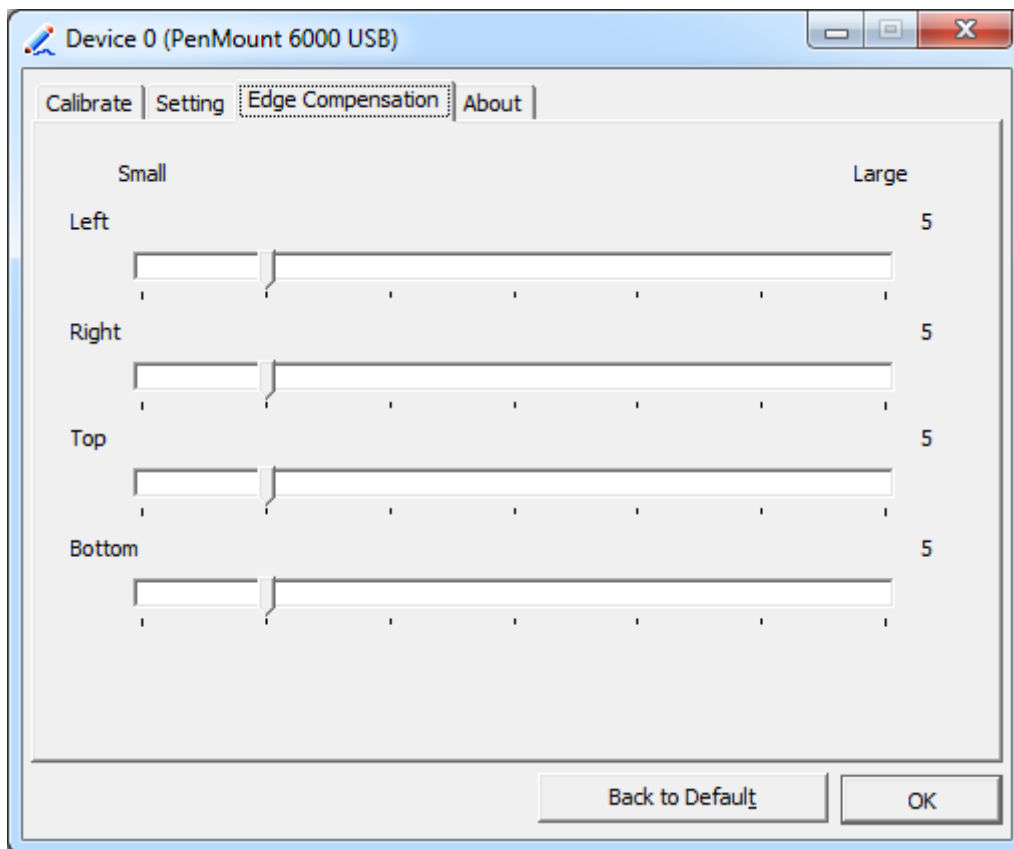

## About

This panel displays information about the PenMount controller and driver version.

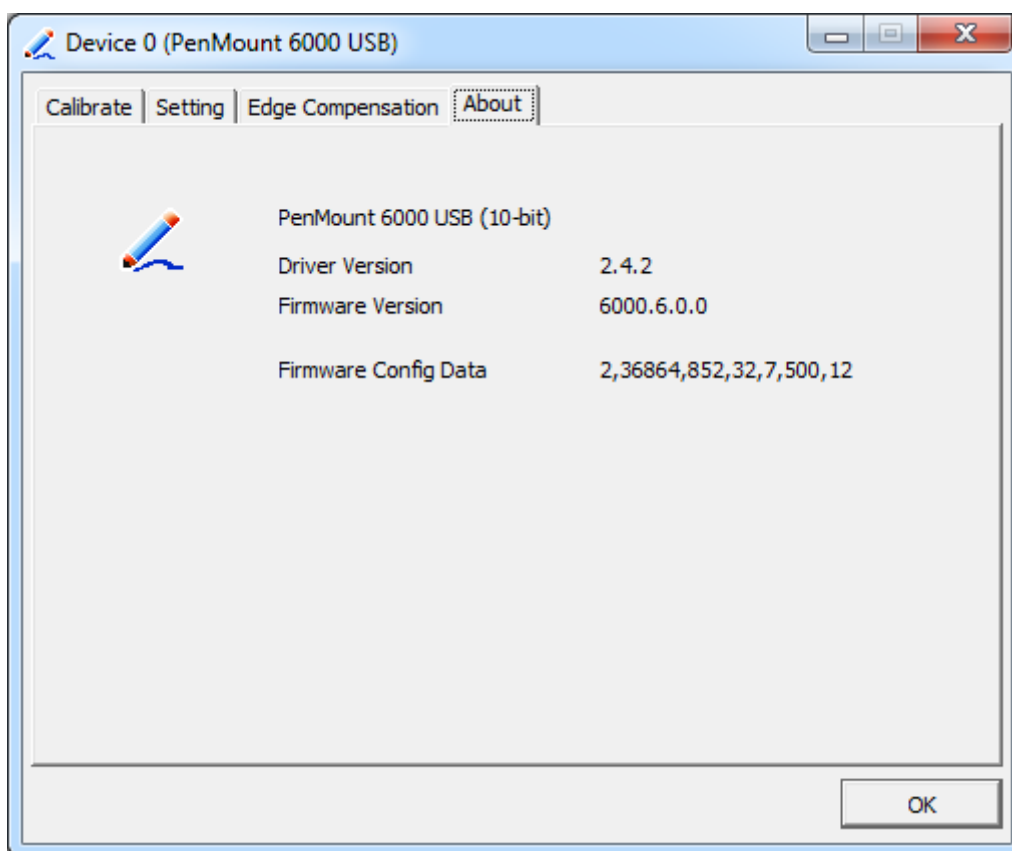

## Multiple Monitors

Multiple Monitors support from two to six touch screen displays for one system. The PenMount drivers for Windows 7/8.1 support Multiple Monitors. This function supports from two to six touch screen displays for one system. Each monitor requires its own PenMount touch screen control board, either installed inside the display or in a central unit. The PenMount control boards must be connected to the computer COM ports via the USB interface. Driver installation procedures are the same as for a single monitor. Multiple Monitors support the following modes:

- Windows Extends Monitor Function
- Matrox DualHead Multi-Screen Function
- nVidia nView Function

**NOTE:** The Multiple Monitor function is for use with multiple displays only. Do not use this function if you have only one touch screen display. Please note once you turn on this function the rotating function is disabled.

Enable the multiple display function as follows:

1. Check the **Enable Multiple Monitor Support** box; then click **Map Touch Screens** to assign touch controllers to displays.

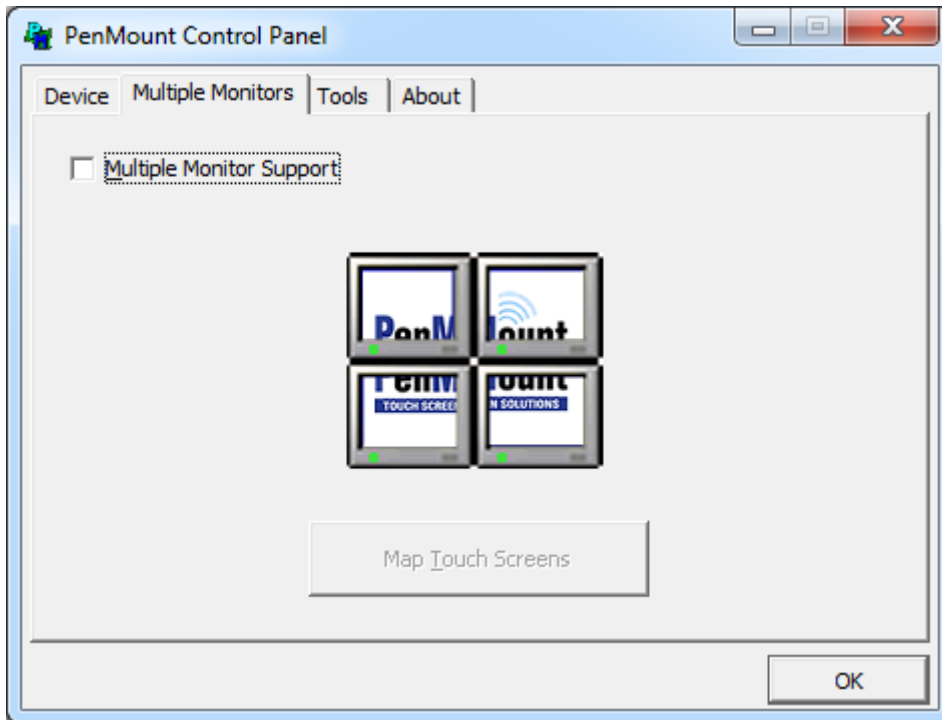

2. When the mapping screen message appears, click **OK**.
3. Touch each screen as it displays “Please touch this monitor”. Following this sequence and touching each screen is called **mapping the touch screens**.

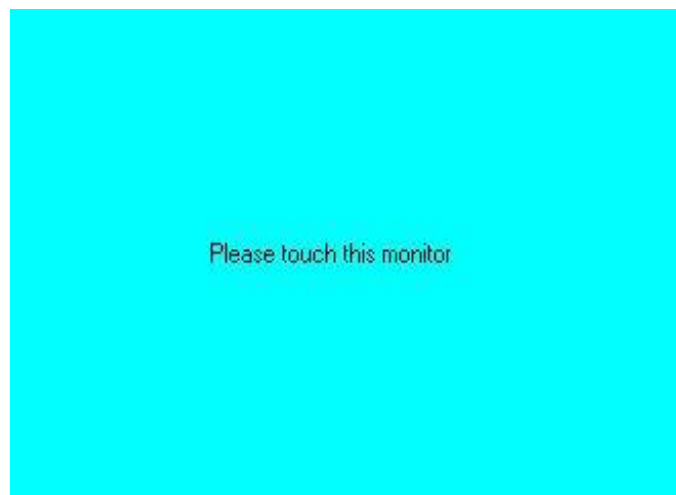

4. Touching all screens completes the mapping and the desktop reappears on the monitors.
5. Select a display and execute the “Calibration” function. A message to start calibration appears. Click **OK**.

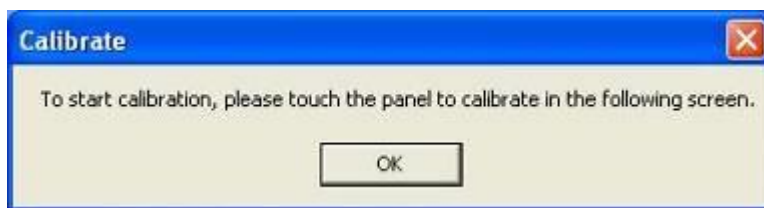

6. "Touch this screen to start its calibration" appears on one of the screens. Touch the screen.
7. "Touch the red square" messages appear. Touch the red squares in sequence.
8. Continue calibration for each monitor by clicking **Standard Calibration** and touching the red squares.

**NOTES:**

1. If you use a single VGA output for multiple monitors, please do not use the **Multiple Monitor** function. Just follow the regular procedure for calibration on each of your desktop monitors.
2. The Rotating function is disabled if you use the Multiple Monitor function.
3. If you change the resolution of display or screen address, you have to redo **Map Touch Screens**, so the system understands where the displays are.

**About**

This panel displays information about the PenMount controller and this driver version.

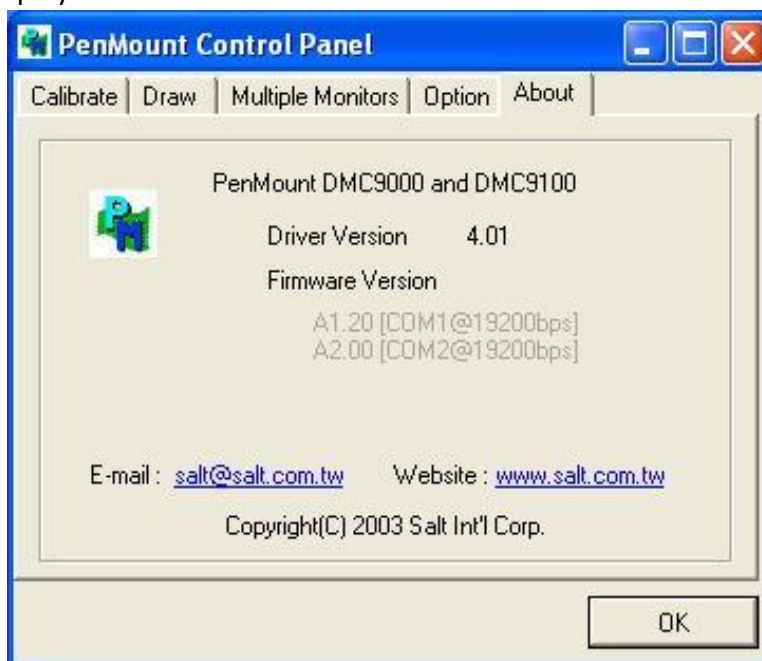

**PenMount Monitor Menu Icon**

The PenMount monitor icon (PM) appears in the menu bar of Windows 7/8.1 system when you turn on PenMount Monitor in PenMount Utilities.





PenMount Monitor has the following function

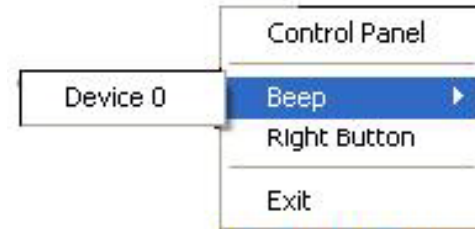

Control Panel	<b>Open Control Panel Windows</b>
Beep	<b>Setting Beep function for each device</b>
Right Button	<b>When you select this function, a mouse icon appears in the right-bottom of the screen. Click this icon to switch between Right and Left Button functions.</b> 
Exit	<b>Exits the PenMount Monitor function.</b>

### Configuring the Rotate Function

1. Install the rotation software package.
2. Choose the rotate function (0°, 90°, 180°, 270°) in the 3rd party software. The calibration screen appears automatically. Touch this point and rotation is mapped.

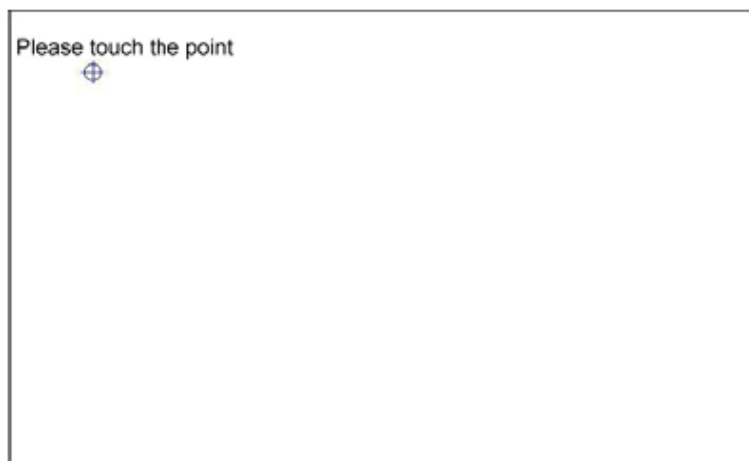

**NOTE:** The Rotate function is disabled if you use Monitor Mapping

## 5.2.2 Software Functions(Projected Capacitive)

### General

In this window, you can see there is USB Controller. Click **OK** to continue.

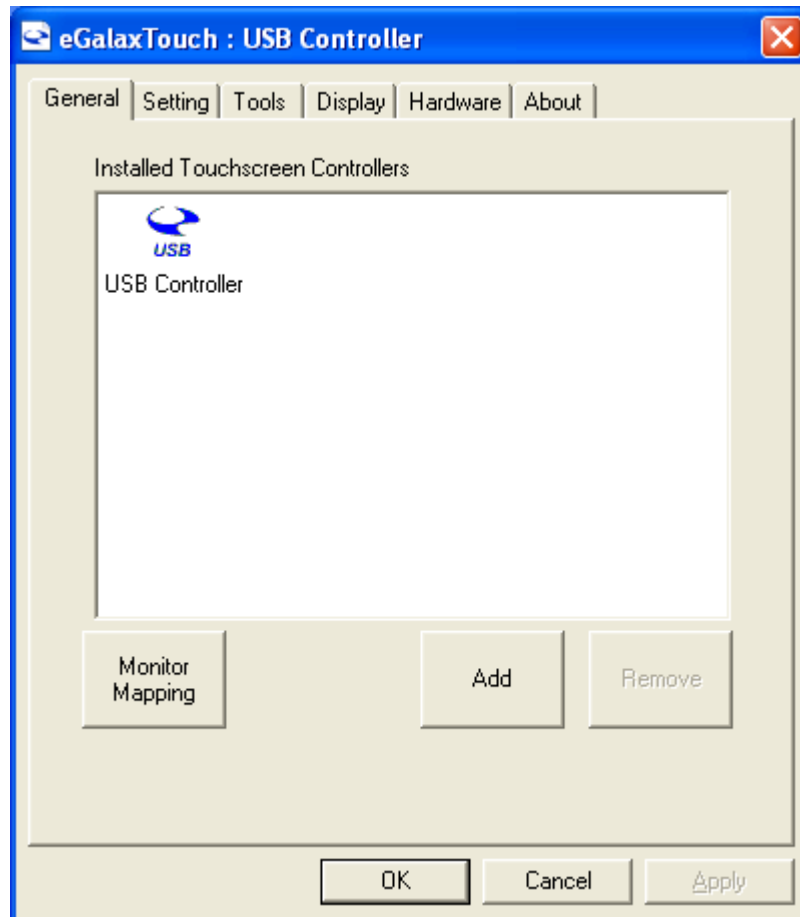

#### **Monitor Mapping**

to adjust touch panel

#### **Add**

to search for device

## Setting

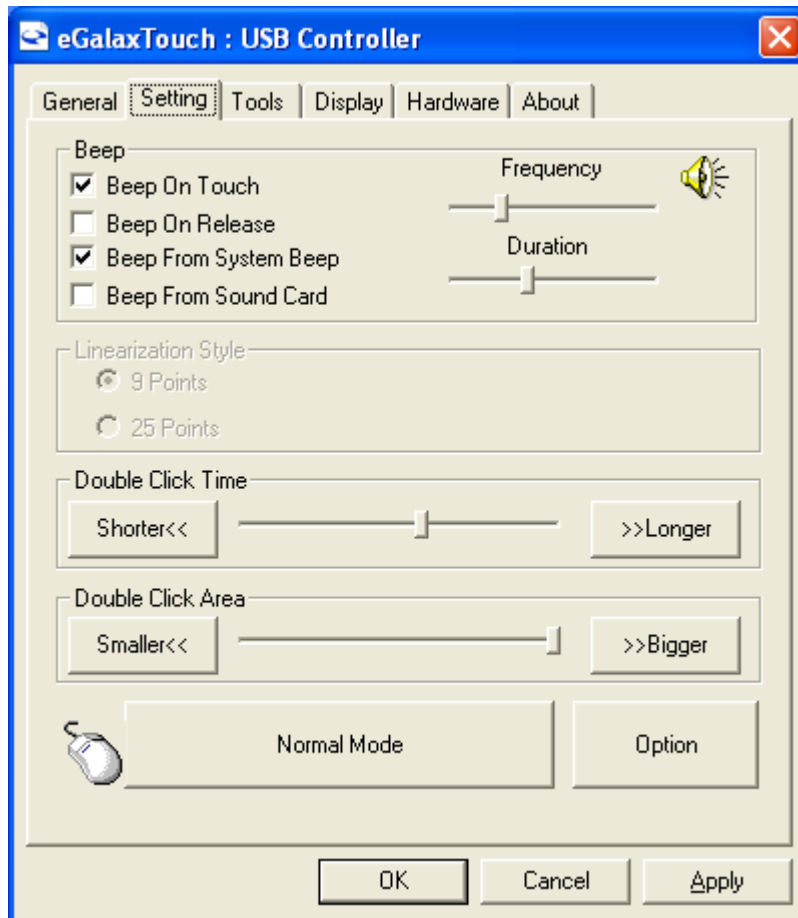

### Beep

- Beep On Touch
- Beep On Release
- Beep From System Beep
- Beep From Sound Card

### Linearization Style

- 9 points
- 25 points

### Double Click Time

- Shorter
- Longer

### Double Click Area

- Smaller
- Bigger

### Normal mode

- Simulate the mouse mode

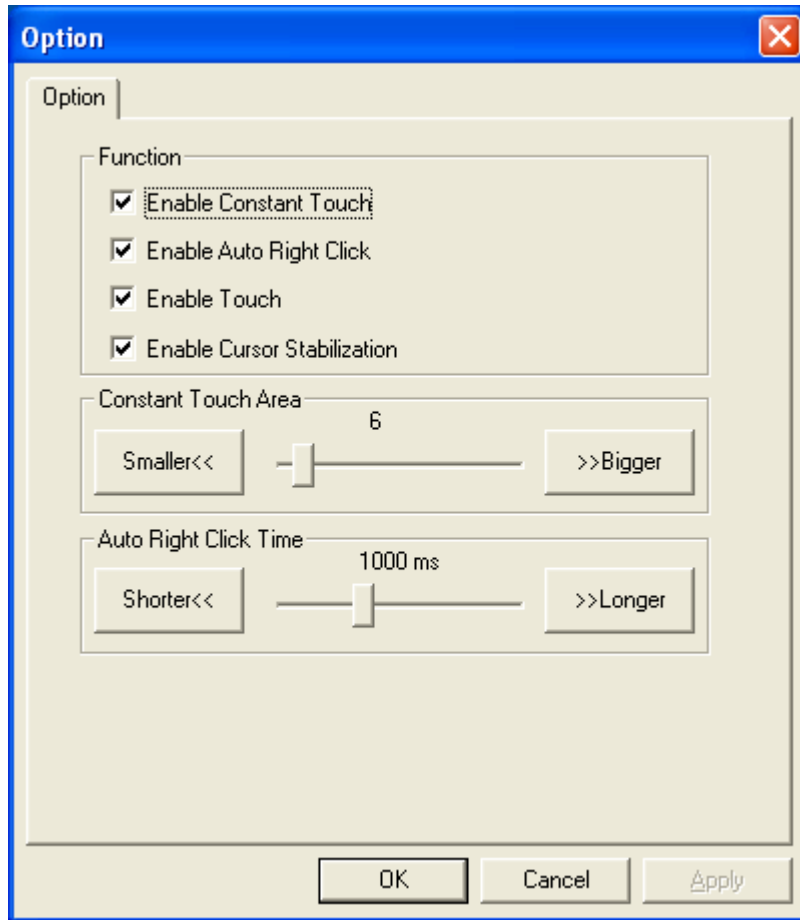

### Option

Function

Enable Constant Touch

Enable Auto Right Click

Enable Touch

Enable Cursor Stabilization

Constant Touch Area

Auto Right Click Time

## Tools

Click **OK** to continue the settings.

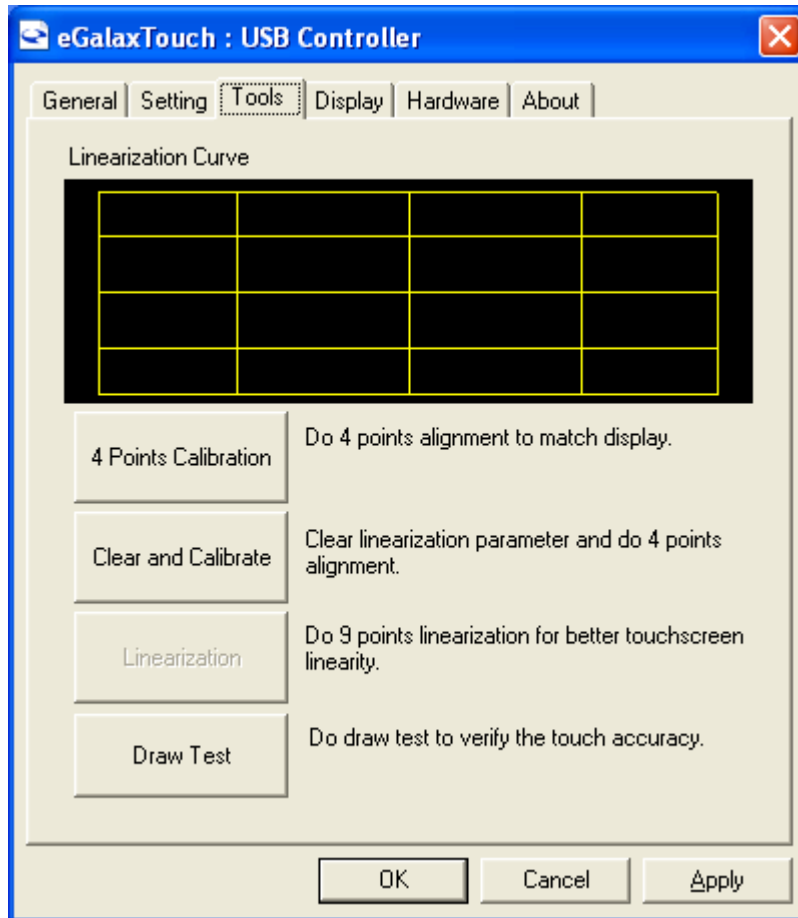

### **4 Points Calibration**

Do 4 points alignment to match display.

### **Clear and Calibrate**

Clear linearization parameter and do 4 points alignment.

### **Linearization**

Do 9 points linearization for better touchscreen linearity.

### **Draw Test**

Do draw test to verify the touch accuracy.

## Display

In this window, it shows the mode of display.

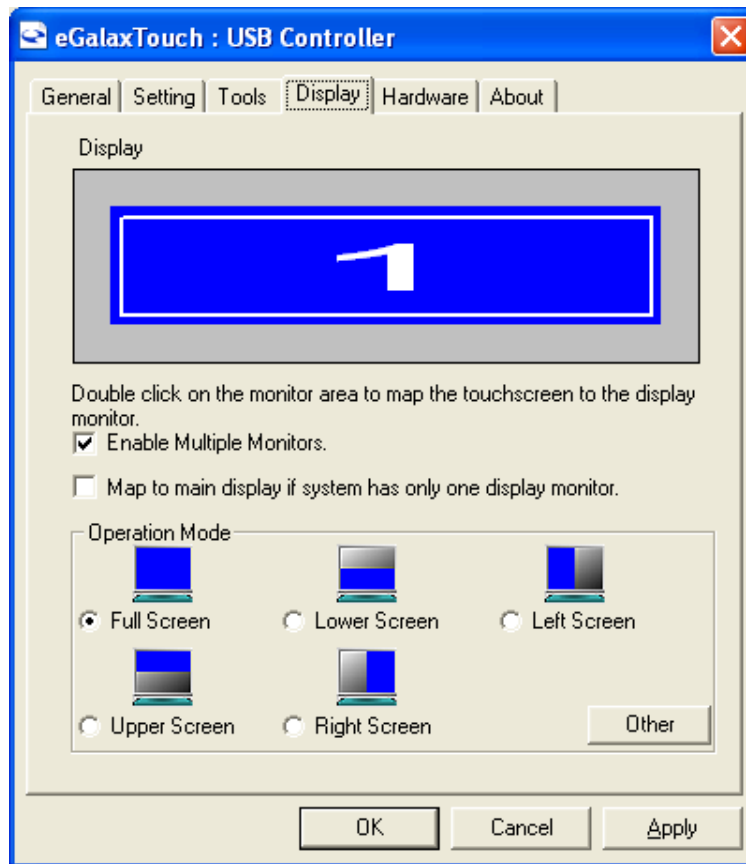

**Enable Multiple Monitors.**

**Map to main display if system has only one display monitor**

Full Screen

Lower Screen

Left Screen

Upper Screen

Right Screen

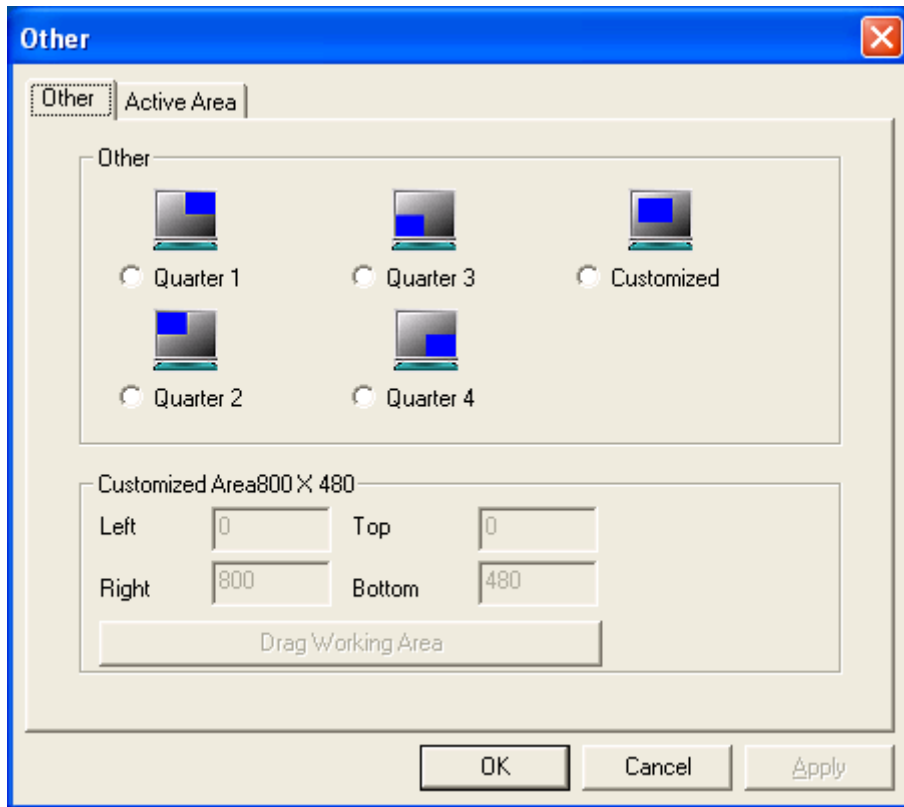

**Other**

Other mode of display. Quarter1~4 and Customized area.

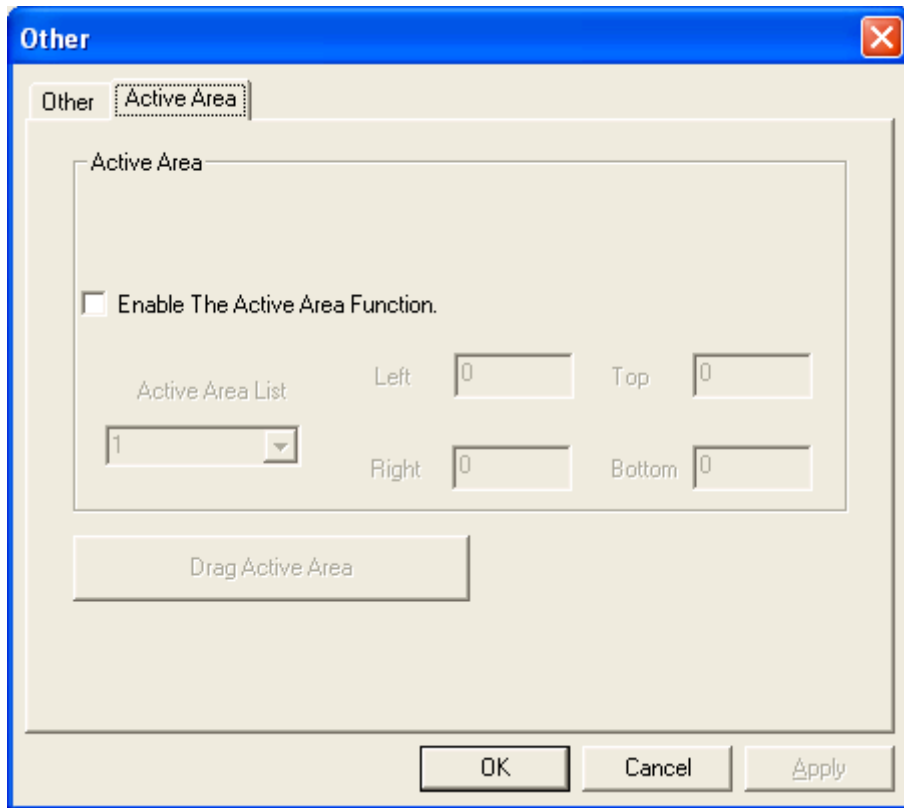

**Active Area**

Drag active area to enable Active Area Function.

## Hardware

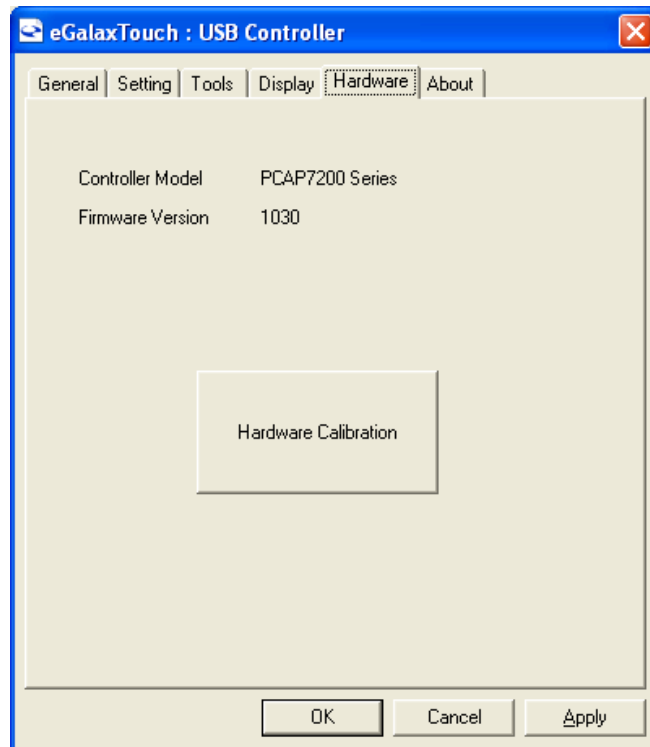

## Saturn Hardware Configuration

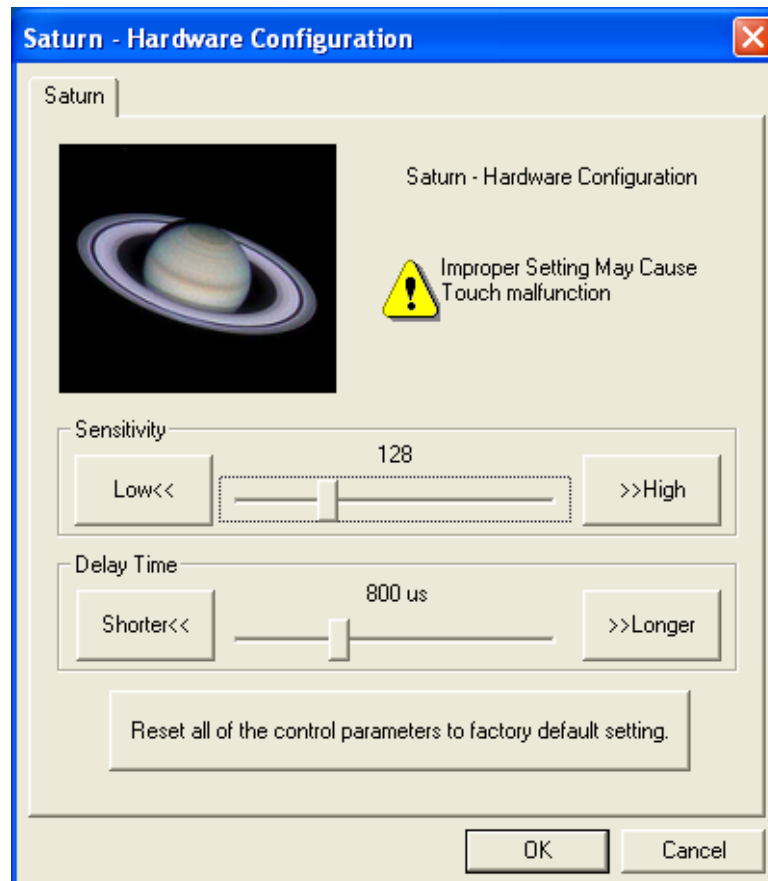



## About

To display information about eGalaxTouch and its version.

